ophthalmologie
ophthalmology
oftalmología
ophthalmologie
oftalmologia

nopa[®] instruments





Dies ist unser Katalog, er bleibt unser ausschließliches Eigentum. Es gelten unsere allgemeinen Lieferbedingungen. Sie finden diese auf unserer Internetseite: www.nopa-instruments.com.

This is our Catalogue. It remains our exclusive property. Please find our "General Terms of Sale" on our corporate website: www.nopa-instruments.com.

Esto es nuestro catálogo queda nuestra propiedad. Nuestras condiciones generales de venta se encuentran en nuestra página web: www.nopa-instruments.com.

Voilà notre catalogue et il demeure notre propriété. Veuillez consulter nos conditions générales de vente sur notre page Internet: www.nopa-instruments.com.

Questo è nostro catalogo e rimane nostra proprietà. Trovano applicazione le nostre condizioni generali di fornitura, che sono disponibili sul nostro sito: www.nopa-instruments.com.

Modelländerungen vorbehalten. Nachdruck, auch auszugsweise, verboten.
Change of design and pattern reserved. Re-printing, even in extracts, not permitted.
Nos reservamos el derecho de modificaciones sin aviso previo. Reimpresión, también parcialmente, esta prohibido.
Tous droits réservés aux changements de modèle. Réimprimer, également partiellement, est interdit.
Noi riserviamo il diritto di effettuare delle modificazioni. Ristampa di divieto anche parziale.

Anatomie des Auges
 Anatomy of the eye
 Anatomia del ojo
 Anatomie des yeux
 Anatomia dell' occhio

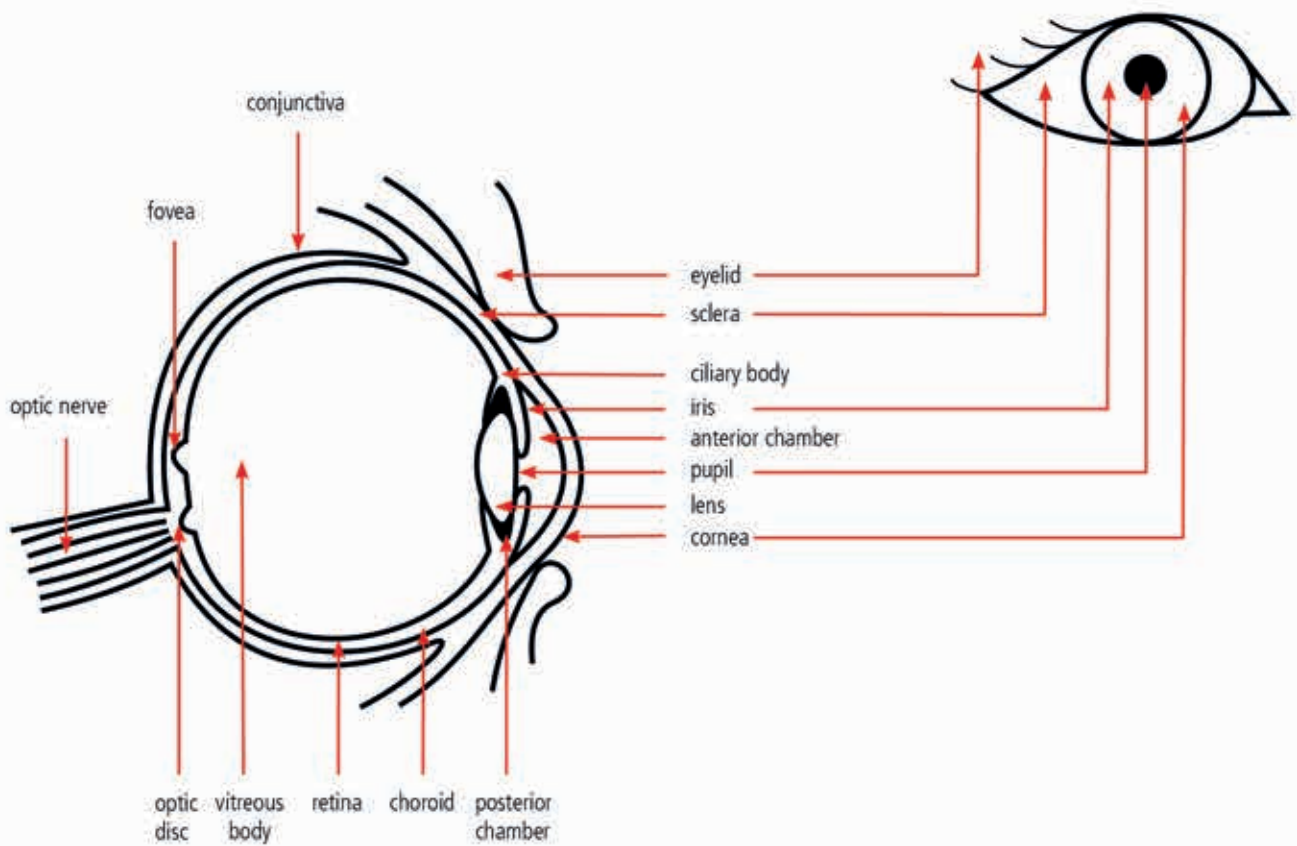

CATALOGUES

Bitte fordern Sie unsere
entsprechenden Kataloge an.

Please request for our
appropriate catalogues.

Por favor pidan por nuestros
catálogos apropiados.

Veillez demander nos
catalogues appropriés.

Vogliate richiedere i nostri
cataloghi adatti.

>> Unser Lieferprogramm

Allgemeinchirurgie
Gynäkologie, Geburtshilfe und Urologie
Plastische Chirurgie und HNO
Thorax, Herz und Gefäßchirurgie
Neurochirurgie
Ophthalmologie
Endoskopie
Container und Sterilisation
Dental und Oral

>> Our product range

General Surgery
Gynecology, obstetrics and urology
Plastic Surgery and ENT
Thoracic and cardiovascular surgery
Neurosurgery
Ophthalmology
Endoscopy
Container and Sterilization
Dental and Oral

>> Nuestra gama de productos

Cirugía general
Ginecología, obstetricia y urología
Cirugía plástica y ORL
Cirugía torácica y cardiovascular
Neurocirugía
Oftalmología
Endoscopia
Contenedor y esterilización
Odontología y oral

>> Notre gamme

Chirurgie générale
Gynécologie, obstétrique et urologie
Chirurgie plastique et ORL
Chirurgie thoracique et cardiovasculaire
Neurochirurgie
Ophtalmologie
Endoscopie
Conteneur et stérilisation
Dental et Oral

>> Nostro programma di produzione

Chirurgia generale
Ginecologia, ostetricia e urologia
Chirurgia plastica ed ORL
Chirurgia toracica e cardiovascolare
Neurochirurgia
Oftalmologia
Endoscopia
Contentitore e sterilizzazione
Odontoiatria e Orale

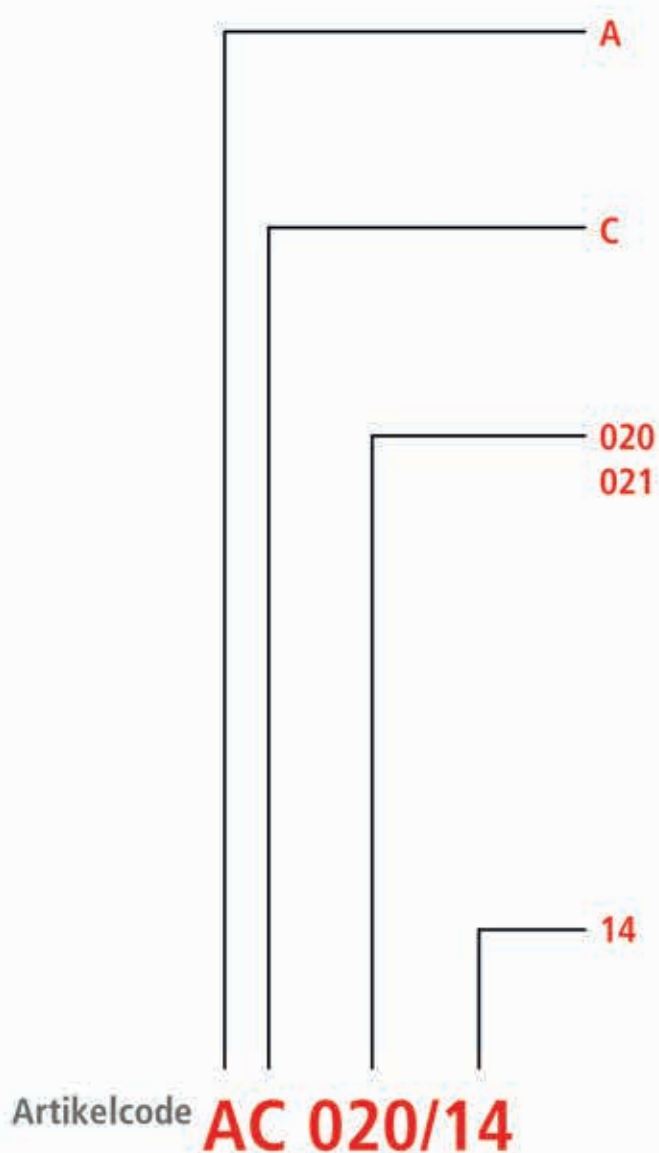
**Allgemeines Instrumentarium**

General Instruments
Instrumental Général
Instruments Générales
Strumenti generali

Scheren

Scissors
Tijeras
Ciseaux
Forbici

Fortlaufende Nummern

Gerade Ziffer = gerades Instrument
Ungerade Ziffer = gebogenes Instrument

Continuous number

Even number = straight instrument
Odd number = curved instrument

Número de orden

números pares = instrumento derecho
números impares = instrumento curvado

Numéros d'ordre

numéro pair = instrument droit
numéro impair = instrument courbe

Numeri progressivi

numero pari = strumento retto
numero dispari = strumento curvo

Länge oder Figur

Length or Figure
Longitud o figura
Longueur ou figure
Lunghezza o figura

INDEX SETS

ZS 160/00	>> Notfall • Emergency • emergencia • urgence • emergenza	11-16
ZS 160/05	>> Fremdkörper • Foreign Body • cuerpo extraño • corps étranger • corpo estraneo	17
ZS 160/10	>> Nahtentfernung • Stitch Removal • retiro de suturas • enlèvement de suture • togliere la sutura	18
ZS 160/15	>> Strabismus / Muskel • Strabismus / Muscle • estrabismo / musculo • strabisme / muscle • strabismo / muscolo	19-22
ZS 160/20	>> Chalazion • Chalazion • chalazión • chalazion • calazio	23-24
ZS 160/25	>> Enukleation • Enucléation • enucleación • énucléation • enucleazione	25-28
ZS 160/30	>> Glaukom • Glaucoma • glaucoma • glaucome • glaucoma	29-32
ZS 160/35	>> Katarakt E.C. • Cataract E.C. • catarata E.C. • cataracte E.C. • cataratta E.C.	33-38
ZS 160/40	>> Katarakt Linse • Cataract Phacoemulsification • catarata facoemulsificación • cataracte phacoémulsification • cataratta facoemulsificazione	39-44
ZS 160/45	>> Keratoplastik • Keratoplasty • queratoplastia • kératoplastie • cheratoplastica	45-48
ZS 160/50	>> Keratomie astigmatisch • Astigmatic Keratotomy • queratoplastia astigmatismo • kératotomie astigmaté • cheratotomia astigmatica	49-50
ZS 160/55	>> Netzhautablösung • Retinal Detachment • desprendimiento de retina DR • décollement de la rétine • distacco della retina	51-56
ZS 160/60	>> Lid-Konjunktiva • Lid-Conjunctiva • conjunctiva • paupière-conjonctive • congiuntiva	57-60
ZS 160/65	>> Pterygium • Pterygium • pterigión • ptérygion • pterigio	61-62
ZS 160/70	>> Dacryocystorhinostomie • Dacryocystorhinostomy • dacriocistorinostomia • dacryocystorhinostomie • dacriocistorinostomia	63-66
ZS 160/75	>> Lasik • Lasik • lasik • lasik • lasik	67-68
ZS 160/80	>> Radiäre Keratotomie • Radiale Keratotomy • queratotomía radial • kératotomie radiale • cheratotomia radiale	69-70
ZS 160/85	>> Vitrektomie (Pars Plana) • Vitrectomy (Pars Plana) • vitrectomía pars-plana • vitrectomie (pars plana) • vitrectomia pars-plana	71-74

INDEX INSTRUMENTS

>> Klemmen • Hemostats • Pinzas hemostáticas Pinces hémostatiques • Pinze emostatiche	75-80	AA
>> Pinzetten • Forceps • Pinzas • Pínces • Pinze	81-98	AB
>> Scheren • Scissors • Tijeras • Ciseaux • Forbici	99-118	AC
>> Skalpelle • Scalpels • Bisturies • Bistouris • Bisturi	119-124	AD
>> Naht • Suture • Sutura • Suture • Sutura	125-134	AE
>> Diagnostik • Diagnostics • Diagnóstico • Diagnostic • Diagnostica	141-144	AR
>> Ophthalmologie • Ophthalmology • Oftalmología Ophthalmologie • Oftalmología	145-206	KP
>> Endoskopie • Endoscopy • Endoscopia • Endoscopie • Endoscopia	207-210	XR

KYE

- >> Bitte fordern Sie unseren Spezialkatalog für Sterilisationscontainer an.
- >> Please request for our special catalogue for Sterilization Containers.
- >> Por favor pida por nuestro catálogo especial de contenedores de esterilización.
- >> Nous vous prions de demander notre catalogue spécial des conteneurs de stérilisation.
- >> Chieda prego il nostro catalogo per contenitori di sterilizzazione.

Contents:		Qty
AA 060/03	DIEFFENBACH BULLDOG CLAMPS STR 3,5 CM	2
AA 150/12	HALSTED-MOSQUITO FCPS STR 12,5 CM	2
AA 151/12	HALSTED-MOSQUITO FCPS CVD 12,5 CM	2
AA 711/09	JONES TOWEL FORCEPS 9,0 CM	2
AB 710/10	GRAEFE IRIS FORCEPS STR SERR. 10,0 CM	1
AB 734/01	BONN IRIS FORCEPS W.GUIDE PIN 1X2T. 7,0 CM	1
AB 738/08	BISHOP-HARMAN IRIS FORCEPS 1X2 T. 8,5 CM	1
AB 750/07	BARRAQUER-KATZIN FIX.FCPS 1X2 T. 7,0 CM	1
AB 796/02	LESTER FIXATION FORCEPS 1X2 TEETH 9,0 CM	1
AB 816/01	CASTROVIEJO SUTURE FORCEPS 0,12 MM 10,0 CM	2
AB 820/10	KELMAN-MCPHERSON TYING FORCEPS 10,0 CM	1
AB 828/10	PAUFIQUE SUTURE FORCEPS 1X2 TEETH 10,0 CM	1
AC 431/08	MOD.BONN SCISSORS CVD 8,0 CM	1
AC 466/10	IRIS SCISSORS STR W LARGE BOWS 10,0 CM	1
AC 475/11	STEVENS TENOTOM.SCS.CVD POINTED 11,5 CM	1
AC 768/05	BARRAQUER EYE SCISSORS 5,5 CM 5 MM	1
AC 782/11	WESTCOTT TENOTOMY SCISSORS BLUNT 11,0 CM	1
AC 797/01	WESTCOTT STRABISMUS SCS STR SHARP 11,5 CM	1
AD 540/00	RAZER BLADES, PACKING UNIT 10 PIECES	1
AD 550/09	BLADE BREAKER 9.0 CM DIA 5,5 MM	1
AE 600/10	BARRAQUER-TROUTMAN MICRO-NH STR RA 10,0 CM	1
AE 602/10	BARRAQUER-TROUTMAN MICRO-NH STR 10,0 CM	1
AE 660/14	CASTROVIEJO NH STR RA SMOOTH 14,0 CM	1
AK 090/10	DESMARRES RETRACTOR 10 MM 13,0 CM	1
AK 090/12	DESMARRES RETRACTOR 12 MM 13,0 CM	1
AK 090/14	DESMARRES RETRACTOR 14 MM 13,0 CM	1
AR 250/15	MEASURING INSTRUMENT 15,0 CM	1
AR 282/20	CASTROVIEJO CIRCLE 8,0 CM STRAIGHT	1
KP 002/12	JAMESON MUSCLE HOOK 12,0 CM	1
KP 010/14	GASS RETINAL DETACHMENT HOOK 14,0 CM	1
KP 015/02	GRAEFE STRABISMUS HOOK #2 14,0 CM	1
KP 018/12	STEVENS TENOTOMY HOOK 12,0 CM	1
KP 023/01	FIXATION HOOK RIGHT 11,0 CM	1
KP 150/05	BARRAQUER-COLIBRI EYE SPECULA 5,0 MM 3,0 CM	1
KP 150/10	BARRAQUER-COLIBRI EYE SPECULA 10,0 MM 3,0 CM	1
KP 154/04	BARRAQUER PHACO EYE SPECULA 4,0 CM	1
KP 212/08	LIEBERMAN EYE SPECULA 15,0 MM 8,0 CM	1
KP 280/14	SCHÖCKET SCLERAL DEPRESSOR 14,0 CM	1
KP 542/01	SCHIOETZ TONOMETER STRAIGHT SCALE	1
KP 700/00	BISHOP-HARMON ANTERIOR CHAMBER	1
KP 731/27	SAUTTER AIR INJECTION CANNULA 27G 3,5 CM	1
SK 305/05	WIRE BASKET, 485 X 255 X 50 MM	1

Sterilization Container KYE 200/61, if required

Irispinzetten
Iris Forceps
Pinzas para iris
Pinces à iris
Pinze per iride



DIEFFENBACH
AA 060/03
3,5 cm/1¹/₂"

HALSTED-MOSQUITO
AA 150/12 AA 151/12
12,5 cm/5"

JONES
AA 711/09
9,0 cm/3¹/₂"

GRAEFE
AB 710/10
10,0 cm/4"

MOD. BONN 1:2
AB 734/01
7,0 cm/2³/₄"

BISHOP-HARMAN 1:2
AB 738/08
8,5 cm/3¹/₃"



BARRAQUER-KATZIN 1:2
(Colibri)
AB 750/07
7,0 cm/2³/₄"

LESTER
AB 796/02
9,0 cm/3¹/₂"

CASTROVIEJO 1:2
AB 816/01
0,12 mm
10,0 cm/4"

KELMAN-McPHERSON 1:2
AB 820/10
10,0 cm/4"

PAUFIGUE 1:2
AB 828/10
10,0 cm/4"

mit großen Ringen
with large bows
con anillos grandes
avec grands anneaux
con anelli grandi

Sehnenscheren
Tenotomy Scissors
Tijeras para tenotomía
Ciseaux à ténatomie
Forbici per tenotomia

spitz
pointed
agudas
pointues
acuta

gebogen
curved
curvas
courbes
curve

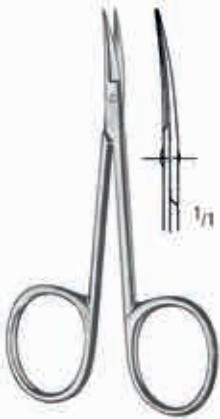

MOD. BONN
AC 431/08
8,0 cm/3"



AC 466/10
10,0 cm/4"

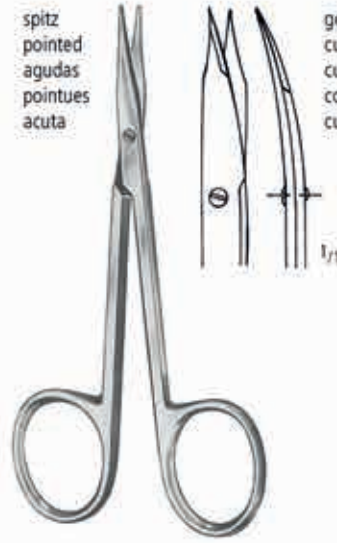

STEVENS
AC 475/11
11,5 cm/4 1/2"



BARRAQUER
5,5 cm/2 1/4"
5 mm AC 768/05

RASIERKLINGEN, VERPACKUNGSEINHEIT 10 STCK
RAZOR BLADES, PACKING UNIT 10 PIECES
HOJAS DE AFEITAR, UNIDAD DE VENTA 10 PZ
LAMES DE RASOIR, UNITÉ À 10 PIÈCES
LAMETTE DA BARBA, UNITÀ DI VENDITA 10 PZ



WESTCOTT
AC 782/11
11,0 cm/4 1/3"



WESTCOTT
AC 797/01
11,5 cm/4 1/2"



AD 540/00



TROUTMAN-CHRIS
AD 550/09
Ø 5,5 mm
9,0 cm/3 1/2"



BARRAQUER-TROUTMAN
AE 600/10
10,0 cm/4"



BARRAQUER-TROUTMAN
AE 602/10
10,0 cm/4"



CASTROVIEJO
AE 660/14
14,0 cm/5 1/2"



AK 090/10
10 mm

AK 090/12
12 mm

AK 090/14
14 mm

DESMARRES
13,0 cm/5"



Messbereich 20 mm
measuring range 20 mm
campo de medición 20 mm
étendue de mesurage 20 mm
ampiezza di misura 20 mm

AR 250/15
15,0 cm/6"



CASTROVIEJO
AR 282/20
8,0 cm/ 3"



JAMESON
KP 002/12
12,0 cm/4³/₄"

GASS
KP 010/14
14,0 cm/5¹/₂"

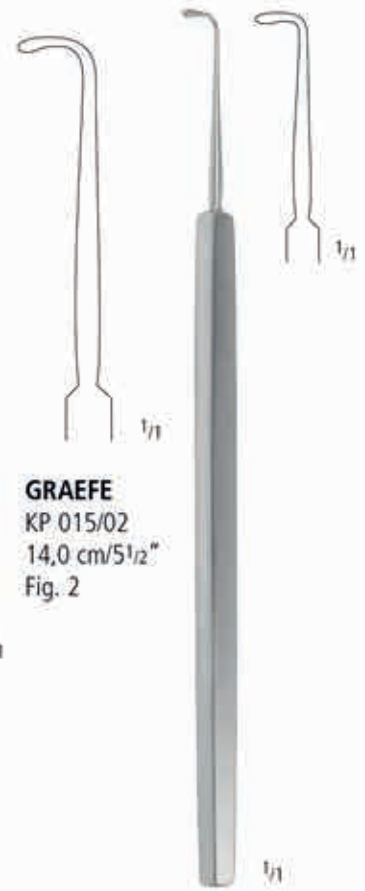

GRAEFE
KP 015/02
14,0 cm/5¹/₂"
Fig. 2

STEVENS
KP 018/12
12,0 cm/4³/₄"



rechts
right
derecha
droit
destra

KP 023/01
11,0 cm/4¹/₂"

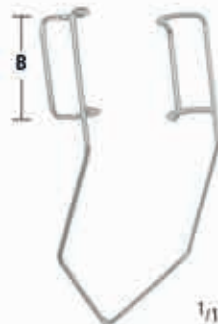

BARRAQUER-COLIBRI
B

Frühgeborene
Premature infant
Parto prematuro
Accouchement prématuré
Parto prematuro

Kind
Child
Niños
Enfants
Bambini

KP 150/05
3,0 cm/1¹/₄"

KP 150/10
3,0 cm/1¹/₄"



BARRAQUER PHAKO
KP 154/04
4,0 cm/1¹/₂"



LIEBERMAN
KP 212/08
8,0 cm/3¹/₄"
B = 15 mm



SCHOCKET
KP 280/14
14,0 cm/5 1/2"



gerade Skala
straight scale
graduado recto
échelle droite
scala retta

SCHIOETZ
KP 542/01
13,0 cm/5"

Spezifikation Nr. 5, geeicht
Specification No. 5, calibrated
Especificación No. 5, calibrada
Spécification No. 5, calibrée
Specifica No. 5, calibrata

Set komplett
Set complete
Juego completo
Jeu complet
Set completo



BISHOP-HARMON
KP 700/00



SAUTER
KP 731/27
3,5 cm/1 1/2"
27G



L(mm)	B(mm)	H(mm)	
485	255	50	SK 305/05

Contents:

Qty

KP 150/15	BARRAQUER-COLIBRI EYE SPECULA 15 MM 4,0 CM	1
KP 350/12	FOREIGN BODY INSTRUMENT	1
KP 415/10	MEYHOEFER CHALAZION CURETTE	1
SX 432/01	SILICON MAT 275 X 125 MM	1

Sterilization container KYE 351/01, if required

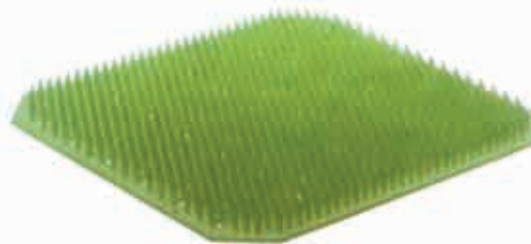
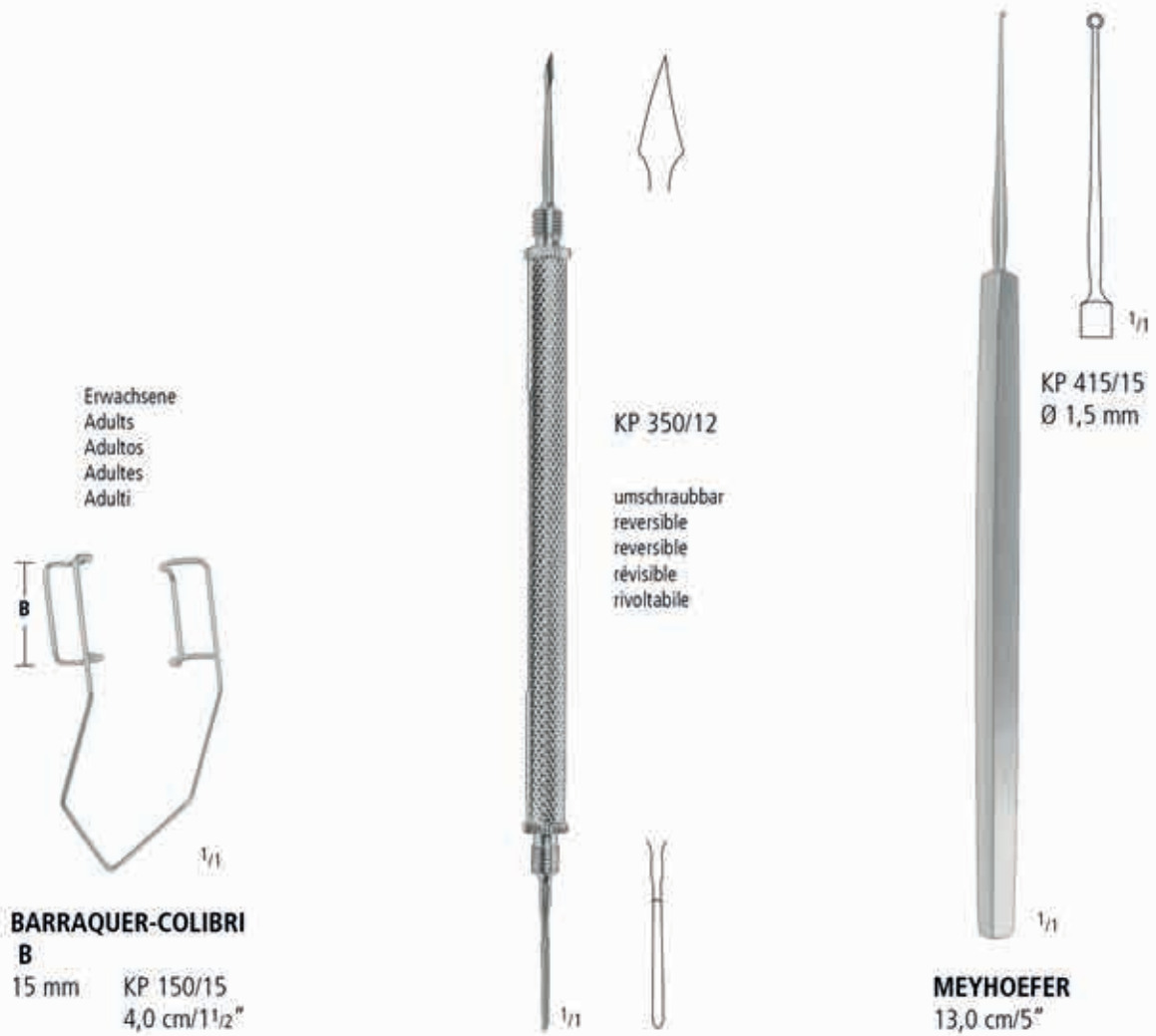

L(mm)	B(mm)	
275	125	SX 432/01

Contents:		Qty
AB 750/07	BARRAQUER-KATZIN FIX.FCPS 1X2 T. 7,0 CM	1
AC 779/01	GILLS-WELSH CAPSULOTOMY SCISSORS 8,5 CM	1
KP 150/15	BARRAQUER-COLIBRI EYE SPECULA 15 MM 4,0 CM	1
SX 432/01	SILICON MAT 275X125 MM	1

Sterilization container KYE 351/01, if required



**BARRAQUER-KATZIN 1:2
(Colibri)**
AB 750/07
7,0 cm/2³/₄"



GILLS-WELSH
AC 779/01
8,5 cm/3¹/₃"



BARRAQUER-COLIBRI
B
15 mm KP 150/15
4,0 cm/1¹/₂"



L(mm)	B(mm)	
275	125	SX 432/01

Contents:		Qty
AA 060/03	DIEFFENBACH BULLDOG CLAMPS STR 3,5 CM	1
AA 114/10	HARTMANN FORCEPS STR 10,0 CM	1
AA 751/13	BACKHAUS TOWEL FORCEPS 13,0 CM	1
AB 734/01	BONN IRIS FORCEPS W.GUIDE PIN 1X2T. 7,0 CM	1
AB 816/01	CASTROVIEJO SUTURE FORCEPS 10,0 CM	2
AB 828/10	PAUFIQUE SUTURE FORCEPS 1X2 TEETH 10,0 CM	1
AB 835/09	BERENS MUSCLE CLAMP 8,5 CM 5 TEETH WITH 1	
AC 450/10	IRIS SCISSORS STR SH/SH 10,5 CM	1
AC 475/11	STEVENS TENOTOM.SCS.CVD POINTED 11,5 CM	1
AC 780/11	WESTCOTT TENOTOMY SCS. POINTED 11,0 CM	1
AC 797/01	WESTCOTT STRABISMUS SCS STR SHARP 11,5 CM	1
AE 660/14	CASTROVIEJO NH STR RA SMOOTH 14,0 CM	1
AE 661/14	CASTROVIEJO NH CVD RA SMOOTH 14,0 CM	1
AR 282/20	CASTROVIEJO CIRCLE 8,0 CM STRAIGHT	1
KP 001/13	GREEN STRABISMUS HOOK 13,0 CM	1
KP 010/14	GASS RETINAL DETACHMENT HOOK 14,0 CM	1
KP 015/01	GRAEFE STRABISMUS HOOK #1 13,0 CM	1
KP 015/02	GRAEFE STRABISMUS HOOK #2 14,0 CM	1
KP 015/03	GRAEFE STRABISMUS HOOK #3 15,0 CM	1
KP 018/12	STEVENS TENOTOMY HOOK 12,0 CM	1
KP 175/09	CASTROVIEJO EYE SPECULA 16,0 MM 9,0 CM	1
KP 262/13	ARRUGA PROTECTOR 13,0 CM	1
KP 540/13	GONNIN AMSLER MARKER 11-23 MM / 1 MM	1
KP 700/00	BISHOP-HARMON ANTERIOR CHAMBER	1
SK 105/05	WIRE BASKET, 255 X 245 X 50 MM	1

Sterilization Container KYE 200/11, if required

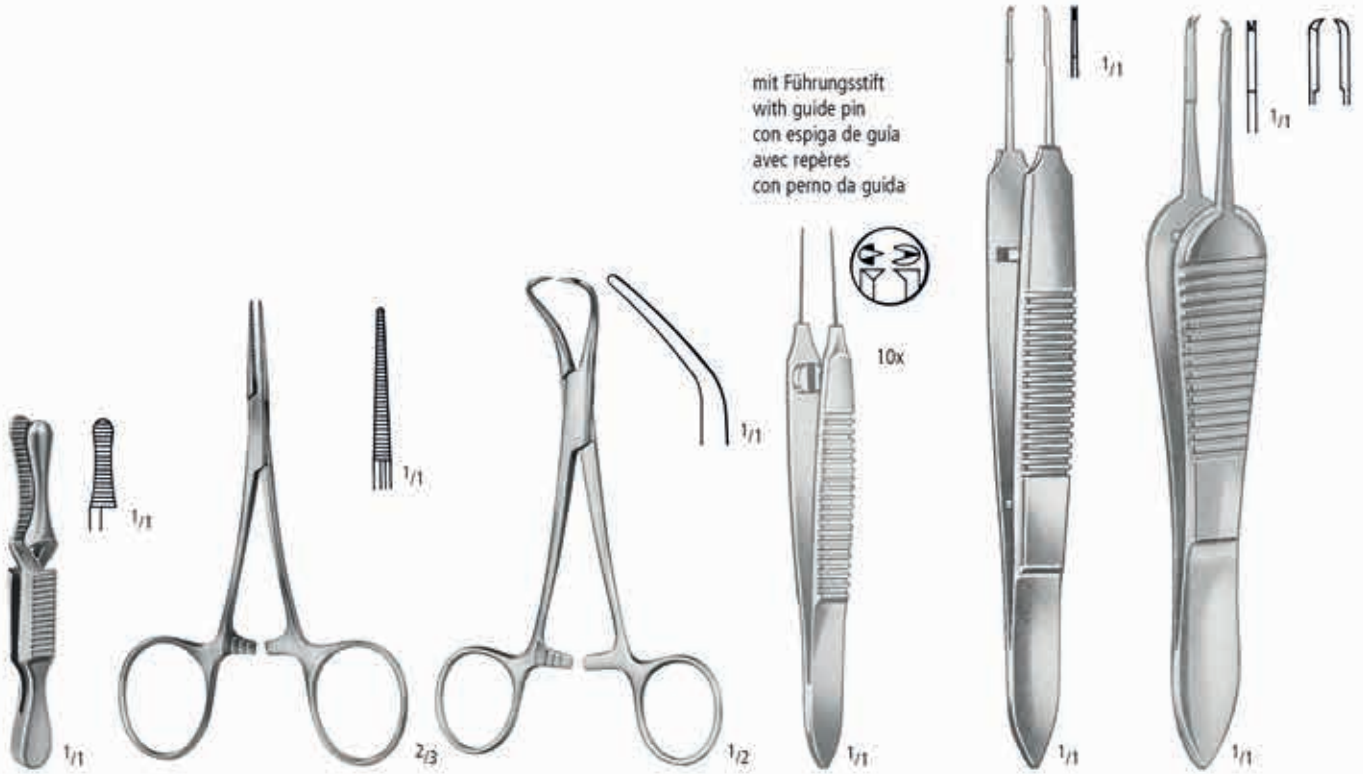

mit Führungsstift
with guide pin
con espiga de guía
avec repères
con perno da guida



10x

DIEFFENBACH
AA 060/03
3,5 cm/1 1/2"

HARTMANN
AA 114/10
10,0 cm/4"

BACKHAUS
AA 751/13
13,0 cm/5"

MOD. BONN 1:2
AB 734/01
7,0 cm/2 3/4"

CASTROVIEJO 1:2
AB 816/01
0,12 mm
10,0 cm/4"

PAUFIQUE 1:2
AB 828/10
10,0 cm/4"

Irisscheren
Iris Scissors
Tijeras para iridectomia
Ciseaux à iridectomie
Forbici per iridectomia

Sehnenscheren
Tenotomy Scissors
Tijeras para tenotomía
Ciseaux à ténotomie
Forbici per tenotomia

spitz
pointed
agudas
pointues
acuta

gebogen
curved
curvas
courbes
curve

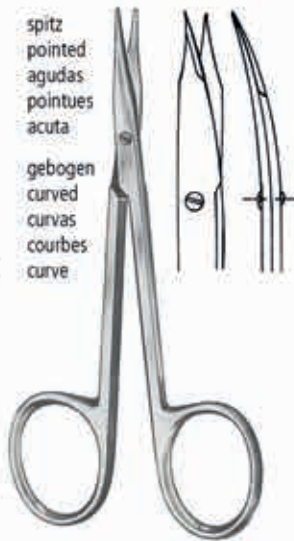

BERENS
AB 835/09
8,5 cm/3 1/3"

AC 450/10
10,5 cm/4 1/4"

STEVENS
AC 475/11
11,5 cm/4 1/2"

WESTCOTT
AC 780/11
11,0 cm/4 1/3"

WESTCOTT
AC 797/01
11,5 cm/4 1/2"

CASTROVIEJO
14,0 cm/5 1/2"

Messbereich 20 mm
measuring range 20 mm
campo de medición 20 mm
étendue de mesurage 20 mm
ampiezza di misura 20 mm



CASTROVIEJO
AR 282/20
8,0 cm/ 3"



GREEN
KP 001/13
13,0 cm/5"



GASS
KP 010/14
14,0 cm/5 1/2"



GRAEFE
KP 015/01
13,0 cm/5"
Fig. 1



GRAEFE
KP 015/02
14,0 cm/5 1/2"
Fig. 2



GRAEFE
KP 015/03
15,0 cm/6"
Fig. 3



STEVENS
KP 018/12
12,0 cm/4 3/4"



CASTROVIEJO
KP 175/09
9,0 cm/3 1/2"
B = 16 mm



ARRUGA
KP 262/13
13,0 cm/5"



GONNIN
KP 540/13
13,0 cm/5"
11-23 mm / 1 mm



BISHOP-HARMON
KP 700/00

Set komplett
Set complete
Juego completo
Jeu complet
Set completo



L(mm)	B(mm)	H(mm)	
255	245	50	SK 105/05

ZS 160/20 CHALAZION CHALAZION CHALAZIÓN CHALAZION CALAZIO

Contents:		Qty
AB 828/10	PAUFIQUE SUTURE FORCEPS 1X2 TEETH 10,0 CM	1
AB 840/01	DESMARRES CHALAZION FORCEPS FIG.1 9,0 CM	1
AB 840/02	DESMARRES CHALAZION FORCEPS FIG.2 9,0 CM	1
AC 467/10	IRIS SCISSORS CVD W LARGE BOWS 10,0 CM	1
AE 661/14	CASTROVIEJO NH CVD RA SMOOTH 14,0 CM	1
KP 248/11	JAEGER LID PLATE 11,0 CM	1
KP 415/10	MEYHOEFER CHALAZION CURETTE 13,0 CM	1
KP 415/20	MEYHOEFER CHALAZIONCURETTE 13,0 CM 2,0 MM	1
KP 415/25	MEYHOEFER CHALAZIONCURETTE 13,0 CM 2,5 MM	1
SK 105/05	WIRE BASKET, 255 X 245 X 50 MM	1

Sterilization Container KYE 200/11, if required



MOD. TÜBINGEN
AB 826/10
10,0 cm/4"



DESMARRES
9,0 cm/3 1/2"



mit großen Ringen
with large bows
con anillos grandes
avec grands anneaux
con anelli grandi

AC 467/10
10,0 cm/4"



CASTROVIEJO
AE 661/14
14,0 cm/5 1/2"



JAEGER
KP 248/11
11,0 cm/4 1/2"

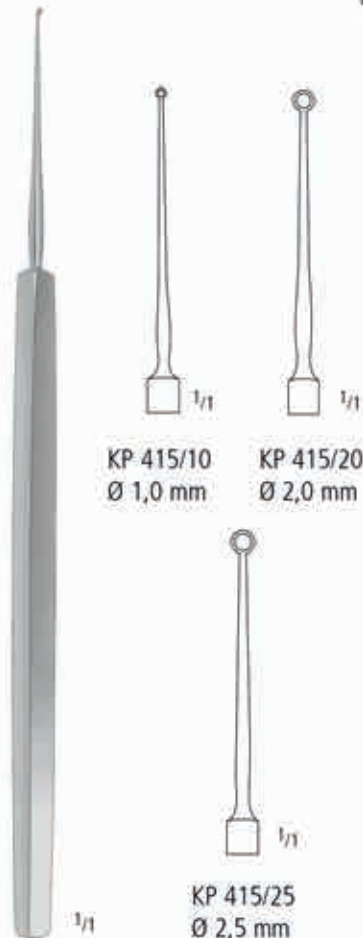

MEYHOEFER
13,0 cm/5"



L(mm)	B(mm)	H(mm)	
255	245	50	SK 105/05

Contents:		Qty
AA 150/14	HALSTED-MOSQUITO ART.FCPS STR 14,0 CM	2
AA 151/14	HALSTED-MOSQUITO ART.FCPS CVD 14,0 CM	2
AA 751/08	BACKHAUS TOWEL FORCEPS 8,0 CM	2
AB 785/01	GRAEFE FIX.FCPS W/O SPRING CATCH 11,0 CM	1
AB 828/10	PAUFIQUE SUTURE FORCEPS 1X2 TEETH 10,0 CM	1
AB 832/01	BLASCOVICS MUSCULAR FORCEPS FIG.1 9,0 CM	1
AC 461/11	STRABISMUS SCISSORS CVD BLUNT 11,5 CM	1
AC 467/10	IRIS SCISSORS CVD W LARGE BOWS 10,0 CM	1
AC 475/11	STEVENS TENOTOM.SCS.CVD POINTED 11,5 CM	1
AE 661/14	CASTROVIEJO NH CVD RA SMOOTH 14,0 CM	1
KP 015/03	GRAEFE STRABISMUS HOOK FIG. 3 15,0 CM	1
KP 200/15	COOK EYE SPECULA 15 MM 5,0 CM	1
KP 400/01	BUNGE EXENTERATION SPOON 14,0 CM 7,0 MM	1
KP 405/15	WELLS ENUCLEATION SPOON LARGE 15,0 CM	1
SK 105/05	WIRE BASKET, 255 X 245 X 50 MM	1

Sterilization Container KYE 200/11, if required



ohne Schloss
without spring catch
sin cierre de resorte
sans arrêt à ressort
senza arresto a molla

HALSTED-MOSQUITO
AA 150/14 AA 151/14
14,0 cm/5 1/2"

BACKHAUS
AA 751/08
8,0 cm/3"

GRAEFE
AB 785/01
11,0 cm/4 1/3"

PAUFIQUE 1:2
AB 828/10
10,0 cm/4"

BLASCOVICS
AB 832/01
9,0 cm/3 1/2"

Strabismusscheren
Strabismus Scissors
Tijeras para estrabismos
Ciseaux à strabisme
Forbici per strabismo

mit großen Ringen
with large bows
con anillos grandes
avec grands anneaux
con anelli grandi

Sehnenscheren
Tenotomy Scissors
Tijeras para tenotomia
Ciseaux à ténatomie
Forbici per tenotomia



AC 460/11
11,5 cm/4 1/2"

AC 467/10
10,0 cm/4"

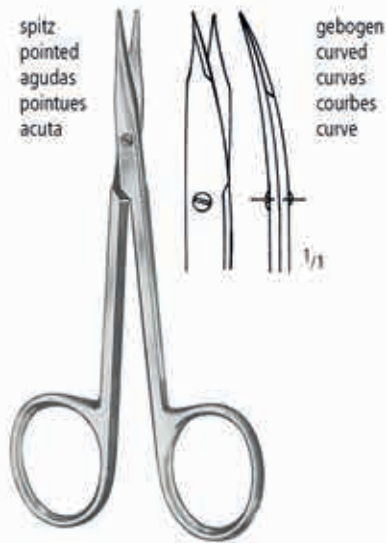

spitz
pointed
agudas
pointues
acuta

gebogen
curved
curvas
courbes
curve

STEVENS
AC 475/11
11,5 cm/4 1/2"

CASTROVIEJO
AE 661/14
14,0 cm/5 1/2"

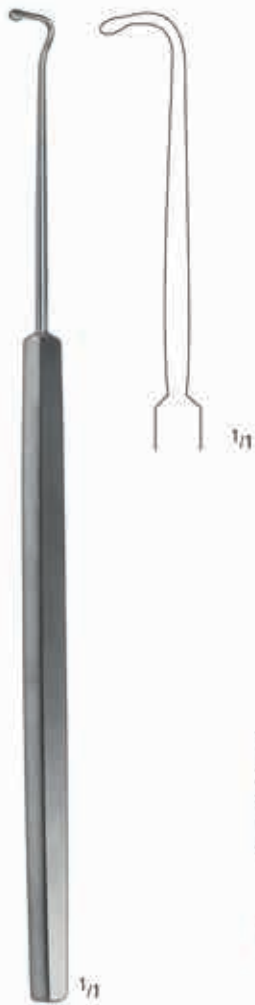

GRAEFE
KP 015/03
15,0 cm/6"
Fig. 3



COOK
B
15 mm
KP 200/15
5,0 cm/ 2"



BUNGE
KP 400/01
14,0 cm/5 1/2"

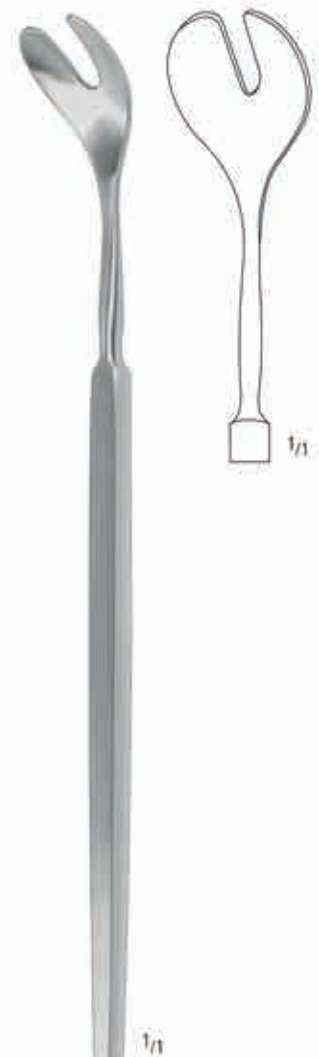

WELLS
KP 405/15
15,0 cm/6"



L(mm)	B(mm)	H(mm)	
255	245	50	SK 105/05

Contents:		Qty
AA 114/10	HARTMANN FORCEPS STR 10,0 CM	1
AA 751/08	BACKHAUS TOWEL FORCEPS 8,0 CM	2
AB 710/10	GRAEFE IRIS FORCEPS STR SERR. 10,0 CM	1
AB 714/10	GRAEFE IRIS FORCEPS STR 1X2 TEETH 10,0 CM	1
AB 734/01	BONN IRIS FORCEPS W.GUIDE PIN 1X2T. 7,0 CM	1
AB 750/07	BARRAQUER-KATZIN FIX.FCPS 1X2 T. 7,0 CM	1
AB 792/11	ELSCHNIG FIXATION FORCPES 1X2 TEETH 11,0 CM	1
AB 825/02	BONN SUTURE FORCEPS 10,0 CM ULRTA FINE	2
AC 431/08	MOD.BONN SCISSORS CVD 8,0 CM	1
AC 768/05	BARRAQUER EYE SCISSORS 5,50 CM 5,0 MM	1
AC 776/02	VANNAS MOD.TÜBINGEN CURVED 8,5 CM	1
AC 782/11	WESTCOTT TENOTOMY SCISSORS BLUNT 11,0 CM	1
AE 605/11	BARRAQUER MICRO-NEEDLE HOLDER CVD 10,0 CM	1
AE 660/14	CASTROVIEJO NH STR RA SMOOTH 14,0 CM	1
AR 282/20	CASTROVIEJO CIRCLE 8,0 CM STRAIGHT	1
KP 130/01	HARMS TRABECULAR PROBE RIGHT 4,5 CM	1
KP 130/02	HARMS TRABECULAR PROBE LEFT 4,5 CM	1
KP 161/05	CORCELLE EYE SPECULA 8 MM, 5,0 CM	1
KP 373/01	PREMIUM DIAMOND KNIFE ANGLED SPEER 1,4 CM	1
KP 376/01	PREMIUM DIAMOND KNIFE 1,0 CM 45° 7 STEPS	1
KP 478/12	MOD.DORTMUND PHACO SPATULA 12,0 CM	1
KP 543/01	SCHIOETZ TONOMETER INCLINED SCALE	1
KP 611/00	ELLIOT TREPHINE HANDLE ONLY 3,0 CM	1
KP 612/10	ELLIOT SCLERAL TREPHINE Ø 1,0 MM	1
KP 700/00	BISHOP-HARMON ANTERIOR CHAMBER	1
KP 712/27	MCINTYRE ANTERIOR CHAMBER CANNULA 27G	2
KP 731/27	SAUTTER AIR INJECTION CANNULA 27G 3,5 CM	2
SK 305/05	WIRE BASKET, 485 X 255 X 50 MM	1

Sterilization Container KYE 200/61, if required



HARTMANN
AA 114/10
10,0 cm/4"

BACKHAUS
AA 751/08
8,0 cm/3"

GRAEFE
10,0 cm/4"

MOD. BONN 1:2
AB 734/01
7,0 cm/2³/₄"



BARRAQUER-KATZIN 1:2
(Colibri)
AB 750/07
7,0 cm/2³/₄"

ELSCHNIG 1:2
AB 792/11
11,0 cm/4¹/₃"

MOD. BONN
AB 825/02
10,0 cm/4"

MOD. BONN
AC 431/08
8,0 cm/3"

BARRAQUER
5 mm AC 768/05
5,5 cm/2¹/₄"

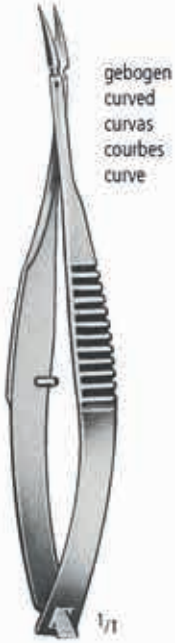

gebogen
curved
curvas
courbes
curve

VANNAS MOD. TÜBINGEN
AC 776/02
8,5 cm/3 1/3"



WESTCOTT
AC 782/11
11,0 cm/4 1/3"



BARRAQUER
AE 605/13
13,0 cm/5"



CASTROVIEJO
AE 660/14
14,0 cm/5 1/2"



CASTROVIEJO
AR 282/15
8,0 cm/ 3"

Messbereich 15 mm
measuring range 15 mm
campo de medición 15 mm
étendue de mesurage 15 mm
ampiezza di misura 15 mm

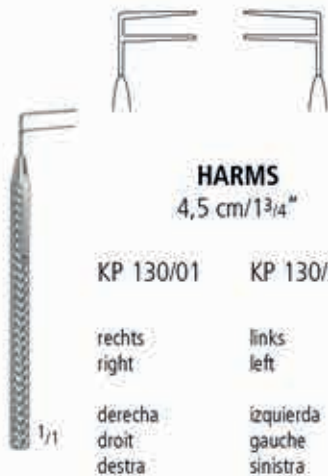

HARMS
4,5 cm/1 3/4"

KP 130/01 KP 130/02

rechts
right

links
left

derecha
droit
destra

izquierda
gauche
sinistra



CORCELLE
KP 161/05
5,0 cm/ 2"
B = 8 mm

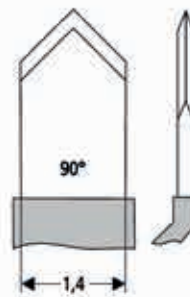

KP 373/01

7 Stufen:
7 steps:
7 escalones:
7 étages:
7 gradí:
0 / 0,3 / 0,4 / 0,5 / 0,6 / 0,8 / 1,0 / 2,5 mm

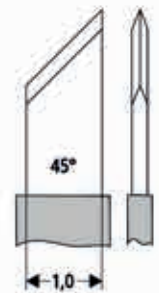

KP 376/01



1/1



1/1



MOD. DORTMUND
 KP 478/12
 12,0 cm/ 4³/₄"
 0,6 x 12 mm



schräge Skala
 inclined scale
 graduado inclinado
 échelle oblique
 scala inclinata

SCHIOETZ
 KP 543/01
 13,0 cm/5"

Spezifikation Nr. 5, geeicht
 Specification No. 5, calibrated
 Especificación No. 5, calibrada
 Spécification No. 5, calibrée
 Specifica No. 5, calibrata



ELLIOT
 KP 611/00
 3,0 cm/1¹/₄"



ELLIOT
 KP 612/10
 Ø 1,0 mm



Set komplett
 Set complete
 Juego completo
 Jeu complet
 Set completo

BISHOP-HARMON
 KP 700/00



McINTYRE
 2,5 cm/1"
 KP 712/27
 27G



SAUTER
 KP 731/27
 3,5 cm/1¹/₂"
 27G



L(mm)	B(mm)	H(mm)	
485	255	50	SK 305/05

Contents:		Qty
AA 060/05	DIEFFENBACH BULLDOG CLAMPS STR 5,0 CM	2
AA 114/10	HARTMANN FORCEPS STR 10,0 CM	1
AA 751/08	BACKHAUS TOWEL FORCEPS 8,0 CM	2
AB 714/10	GRAEFE IRIS FORCEPS STR 1X2 TEETH 10,0 CM	1
AB 735/02	BONN MICRO IRIS FORCEPS ANGLED 7,0 CM	1
AB 750/07	BARRAQUER-KATZIN FIX.FCPS 1X2 T. 7,0 CM	1
AB 768/01	ARRUGA CAPSULAR FCPS NOT CALIBR. 10,0 CM	1
AB 792/11	ELSCHNIG FIXATION FORCPES 1X2 TEETH 11,0 CM	1
AB 819/02	MCPHERSON TYING FORCEPS ANGLED 10,5 CM	1
AB 825/02	BONN SUTURE FORCEPS 10,0 CM ULTRA FINE	1
AB 848/11	FAULKNER LENS HOLDING FORCEPS 11,0 CM	1
AC 431/08	MOD.BONN SCISSORS CVD 8,0 CM	1
AC 768/10	BARRAQUER EYE SCISSORS 5,5 CM 10 MM	1
AC 776/03	VANNAS MOD.TÜBINGEN ANGLED 8,5 CM	1
AC 778/02	VANNAS SEC.CATARACT SCISSORS,CVD. 8,0 CM	1
AC 782/11	WESTCOTT TENOTOMY SCISSORS BLUNT 11,0 CM	1
AC 785/01	CASTROVIEJO DELICATE EYE SCS. 10,0 CM RI.	1
AC 785/02	CASTROVIEJO DELICATE EYE SCS. 10,0 CM LE.	1
AC 797/02	WESTCOTT STRABISMUS SCS CVD SHARP 11,5 CM	1
AD 075/11	PCK=100 BLADES FIG.11	1
AD 554/13	BLADE BREAKER 13.0 CM DIA 8,0 MM	1
AE 603/10	BARRAQUER-TROUTMAN MICRO-NH CVD 10,0 CM	1
AE 660/14	CASTROVIEJO NH STR RA SMOOTH 14,0 CM	1
AE 688/14	KALT MICRO-NEEDLE HOLDER STR 14,0 CM	1
AR 282/20	CASTROVIEJO CIRCLE 8,0 CM STRAIGHT	1
KP 030/13	HIRSCHMANN IRIS HOOK 12,5 CM 45°	1
KP 071/25	SINSKEY LENS MANIPULATOR 12,0 CM	1
KP 154/04	BARRAQUER PHACO EYE SPECULA 4,0 CM	1
KP 440/13	SNELLEN LENS SCOOP SERRATED 13,0 CM	1
KP 478/12	MOD.DORTMUND PHACO SPATULA 12,0 CM	1
KP 545/02	MALONEY KERATOMETER INTRAOPERATIVE 2,0 CM	1
KP 700/00	BISHOP-HARMON ANTERIOR CHAMBER	1
KP 712/27	MCINTYRE ANTERIOR CHAMBER CANNULA 27G	1
KP 720/23	SIMCOE IRRIGATION AND ASPIRATION CANNULA	1
KP 731/27	SAUTTER AIR INJECTION CANNULA 27G 3,5 C	2
KP 755/23	KNOLLE-PEARCE LENS LOOP WITH IRRIGATION	1
KP 767/27	JENSEN CAPSULE POLISHER 27G DIAMOND	1
SK 305/05	WIRE BASKET, 485 X 255 X 50 MM	1

Sterilization Container KYE 200/61, if required



DIEFFENBACH
AA 060/05
5,0 cm/2"



HARTMANN
AA 114/10
10,0 cm/4"



BACKHAUS
AA 751/08
8,0 cm/3"



GRAEFE
AB 714/10
10,0 cm/4"



MOD. BONN
AB 735/02
7,0 cm/2³/₄"



BARRAQUER-KATZIN 1:2 (Colibri)
AB 750/07
7,0 cm/2³/₄"



ungeeicht
not calibrated
non calibrada
non calibrée
non calibrata

ARRUGA
AB 768/01
10,0 cm/4"



ELSCHNIG 1:2
AB 792/11
11,0 cm/4¹/₃"



McPHERSON
AB 819/02
10,0 cm/4"



MOD. BONN
AB 825/02
10,0 cm/4"



FAULKNER
AB 848/11
11,0 cm/4¹/₃"

sehr fein
extra delicate
muy finas
très fin
molto sottile

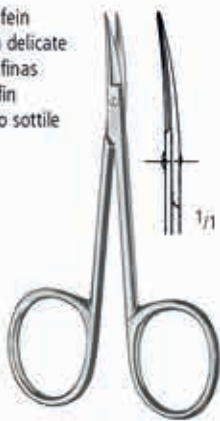

MOD. BONN
AC 431/08
8,0 cm/3"



BARRAQUER
5,5 cm/2 1/4"
10 mm AC 768/10



kniegebogen
angular
acodadas
coudés
angolato

VANNAS MOD. TÜBINGEN
AC 776/03
8,5 cm/3 1/3"

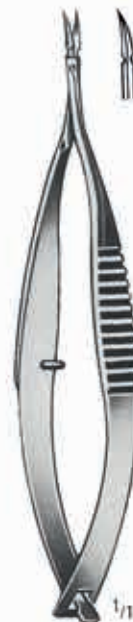

gebogen
curved
curvas
courbes
curve

VANNAS
AC 778/02
8,0 cm/3"



WESTCOTT
AC 782/11
11,0 cm/4 1/3"



CASTROVIEJO
AC 785/01
10,0 cm/4"

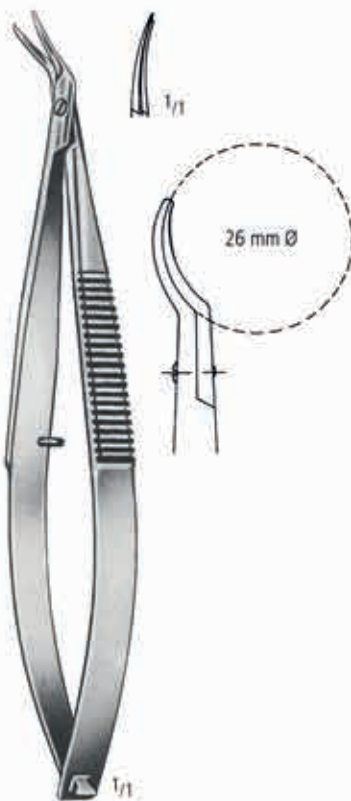

CASTROVIEJO
AC 785/02
10,0 cm/4"



WESTCOTT
AC 797/02
11,5 cm/4 1/2"



Fig. 11
AD 075/11

steril
sterile
estériles
stériles
sterili



CASTROVIEJO
AD 554/13
Ø 8 mm
13,0 cm/5"



BARRAQUER-TROUTMAN
AE 603/10
10,0 cm/4"



CASTROVIEJO
AE 660/14
14,0 cm/5 1/2"



KALT
AE 688/14
14,0 cm/5 1/2"



CASTROVIEJO
AR 282/20
8,0 cm/ 3"

Messbereich 20 mm
measuring range 20 mm
campo de medición 20 mm
étendue de mesurage 20 mm
ampiezza di misura 20 mm



HIRSCHMANN
KP 030/13
12,5 cm/5"



SINSKEY
KP 071/25
Ø 0,25 mm
12,0 cm/4 3/4"

TITANIUM



BARRAQUER PHAKO
KP 154/04
4,0 cm/1 1/2"



SNELLEN
KP 440/13
13,0 cm/5"

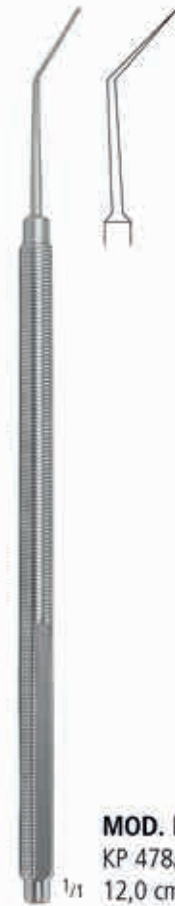

MOD. DORTMUND
KP 478/12
12,0 cm/ 4 3/4"
0,6 x 12 mm



MALONEY
KP 545/02
2,0 cm/3/4"



Set komplett
Set complete
Juego completo
Jeu complet
Set completo



McINTYRE
2,5 cm/1"
KP 712/27
27G

BISHOP-HARMON
KP 700/00



SIMCOE
KP 720/23
3,0 cm/1 1/4"
25/23G



SAUTTER
KP 731/27
3,5 cm/1 1/2"
27G

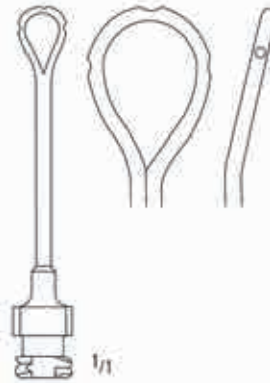

KNOLLE-PEARCE
KP 755/23
5,0 cm/2"
23G

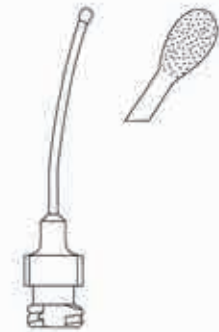

JENSEN
KP 767/27
4,5 cm/2"
27G



L(mm)	B(mm)	H(mm)	
485	255	50	SK 305/05

Contents:		Qty
AA 060/05	DIEFFENBACH BULLDOG CLAMPS STR 5,0 CM	2
AA 150/14	HALSTED-MOSQUITO ART.FCPS STR 14,0 CM	1
AA 751/15	BACKHAUS TOWEL FORCEPS 15,0 CM	2
AB 714/10	GRAEFE IRIS FORCEPS STR 1X2 TEETH 10,0 CM	1
AB 750/07	BARRAQUER-KATZIN FIX.FCPS 1X2 T. 7,0 CM	1
AB 767/02	CASTROVIEJO CAPSULAR FCPS CROSSED 10,0 CM	1
AB 768/01	ARRUGA CAPSULAR FCPS NOT CALIBR. 10,0 CM	1
AB 792/11	ELSCHNIG FIXATION FORCPES 1X2 TEETH 11,0 CM	1
AB 819/02	MCPHERSON TYING FORCEPS ANGLED 10,5 CM	1
AB 825/02	BONN SUTURE FORCEPS 10,0 CM ULRTA FINE	1
AB 848/11	FAULKNER LENS HOLDING FORCEPS 11,0 CM	2
AB 852/02	MCDONALD IOL CAPSULORHEXIS FORCEPS 10,0 CM	1
AC 431/08	MOD.BONN SCISSORS. CVD 8,0 CM	1
AC 776/04	VANNAS MOD.TÜBINGEN ANGLED O.FL. 8,5 CM	1
AC 778/03	VANNAS SEC.CATARACT SCISSORS,ANGULAR, 8,0 CM	1
AC 782/11	WESTCOTT TENOTOMY SCISSORS BLUNT 11,0 CM	1
AD 075/11	PCK=100 BLADES FIG.11	1
AD 550/09	BLADE BREAKER 9.0 CM DIA 5,5 MM	1
AD 551/09	BLADE BREAKER CVD 9.0 CM DIA 5,5 MM	1
AE 605/14	BARRAQUER MICRO-NEEDLE HOLDER CVD 14,0 CM	1
AE 660/14	CASTROVIEJO NH STR RA SMOOTH 14,0 CM	1
AE 688/14	KALT MICRO-NEEDLE HOLDER STR 14,0 CM	1
AR 282/20	CASTROVIEJO CIRCLE 8,0 CM STRAIGHT	1
KP 030/13	HIRSCHMANN IRIS HOOK 12,5 CM 45°	1
KP 040/02	JAFFE-BECHERT LENS NUCLEUS ROTATOR 12,0 CM	1
KP 067/60	NAGAHARA PHACO SPLITTER 12,0 CM 60°	1
KP 071/25	SINSKEY LENS MANIPULATOR 12,0 CM	1
KP 154/04	BARRAQUER PHACO EYE SPECULA 4,0 CM	1
KP 210/02	LIEBERMAN EYE SPECULA 15 MM K-SHAPE 8,0 CM	1
KP 335/12	MOD. HAMBURG KERATOME 12,0 CM	1
KP 370/04	PREMIUM DIAMOND KNIFE ANGLED LANCE 1,4 CM	1
KP 371/01	PREMIUM DIAMOND KNIFE STR.TRI-FACET 1,0 CM	1
KP 371/02	PREMIUM DIAMOND KNIFE ANGLED 2,0 CM	1
KP 545/02	MALONEY KERATOMETER INTRAOPERATIVE 2,0 CM	1
KP 550/12	THORNTON FIXATION RING FG-HINGE Ø13,0 MM	1
KP 700/00	BISHOP-HARMON ANTERIOR CHAMBER	1
KP 712/27	MCINTYRE ANTERIOR CHAMBER CANNULA 27G	1
KP 731/27	SAUTTER AIR INJECTION CANNULA 27G 3,5 CM	1
KP 767/27	JENSEN CAPSULE POLISHER 27G DIAMOND	2
SK 305/05	WIRE BASKET, 485 X 255 X 50 MM	1

Sterilization Container KYE 200/61, if required



DIEFFENBACH
 AA 060/05
 5,0 cm/2"

HALSTED-MOSQUITO
 AA 150/14
 14,0 cm/5 1/2"

BACKHAUS
 AA 751/15
 15,0 cm/6"

GRAEFE
 AB 714/10
 10,0 cm/4"

BARRAQUER-KATZIN 1:2 (Colibri)
 AB 750/07
 7,0 cm/2 3/4"

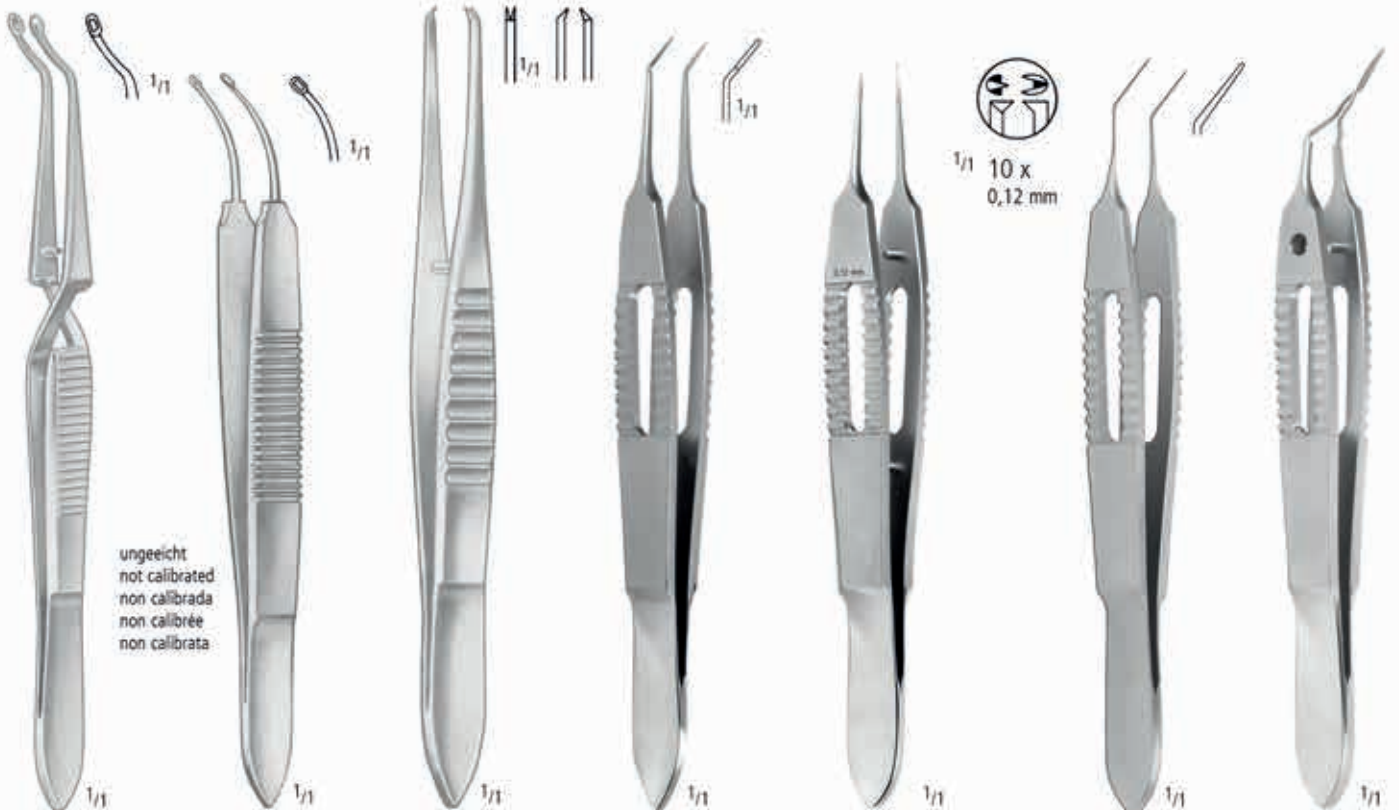

ungeeicht
 not calibrated
 non calibrada
 non calibrée
 non calibrata

CASTROVIEJO
 AB 767/02
 10,0 cm/4"

ARRUGA
 AB 768/01
 10,0 cm/4"

ELSCHMIG 1:2
 AB 792/11
 11,0 cm/4 1/3"

McPHERSON
 AB 819/02
 10,0 cm/4"

MOD. BONN
 AB 825/02
 10,0 cm/4"

FAULKNER
 AB 848/11
 11,0 cm/4 1/3"

McDONALD
 AB 852/02
 10,0 cm/4"

sehr fein
extra delicate
muy finas
très fin
molto sottile

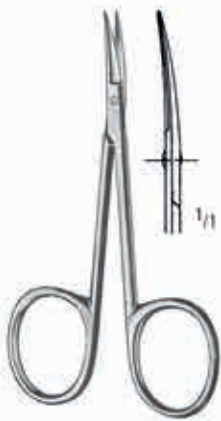

MOD. BONN
AC 431/08
8,0 cm/3"

aufgewinkelt
angled on flat
acodadas hacia arriba
coudés vers le haut
angolato in alto



VANNAS MOD. TÜBINGEN
AC 776/04
8,5 cm/3 1/3"

kniegebogen
angular
acodadas
coudés
angolato



VANNAS
AC 778/03
8,0 cm/3"



WESTCOTT
AC 782/11
11,0 cm/4 1/3"

Fig. 15
AD 075/15

steril
sterile
estériles
stériles
sterili



TROUTMAN-CHRIS
AD 550/09
Ø 5,5 mm
9,0 cm/3 1/2"



TROUTMAN-CHRIS
AD 551/09
Ø 5,5 mm
9,0 cm/3 1/2"



BARRAQUER
AE 605/11
11,0 cm/4 1/3"



CASTROVIEJO
AE 660/14
14,0 cm/5 1/2"



KALT
AE 688/14
14,0 cm/5 1/2"



Messbereich 20 mm
measuring range 20 mm
campo de medición 20 mm
étendue de mesurage 20 mm
ampiezza di misura 20 mm

CASTROVIEJO
AR 282/20
8,0 cm/ 3"



HIRSCHMANN
KP 030/13
12,5 cm/5"



V-Spitze
V-tip
punta V
coudé à fourche
punta V

TITANIUM



Klinge
blade
hoja
lame
lame
stumpfes Eck
blunt edge
canto romo
coin mousse
angolo smussato

TITANIUM

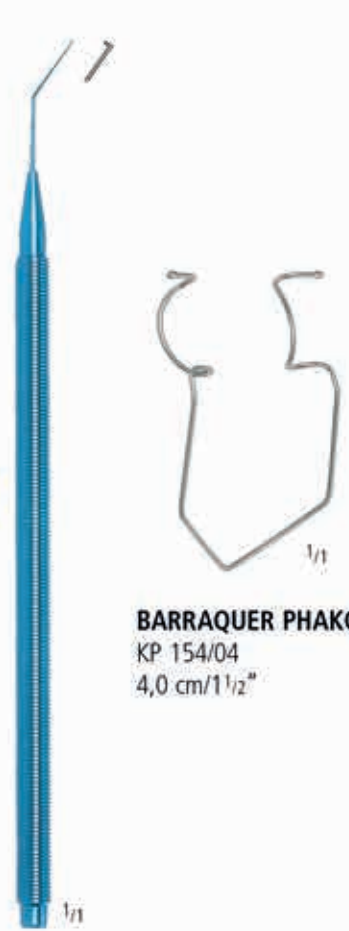

BARRAQUER PHAKO
KP 154/04
4,0 cm/1 1/2"

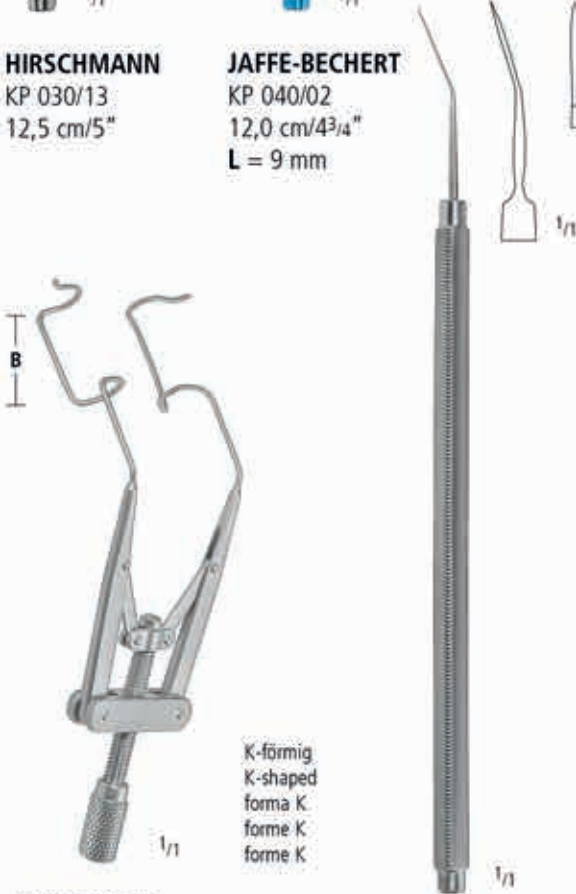

LIEBERMAN
KP 210/02
8,0 cm/3 1/4"
B = 15 mm

K-förmig
K-shaped
forma K
forme K
forme K

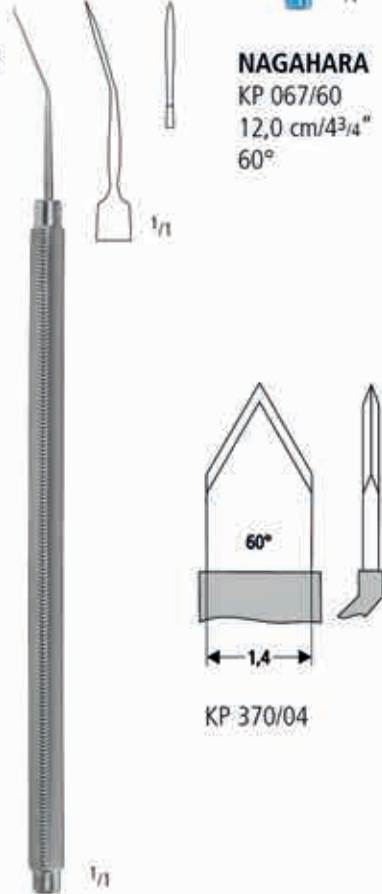

MOD. HAMBURG
KP 335/12
12,0 cm/ 4 3/4"

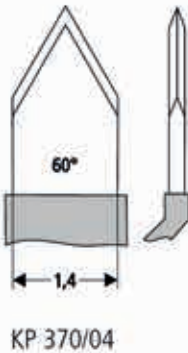

KP 370/04



SINSKEY
KP 071/25
12,0 cm/4 3/4"
Ø 0,25 mm

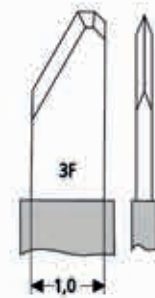

KP 371/01

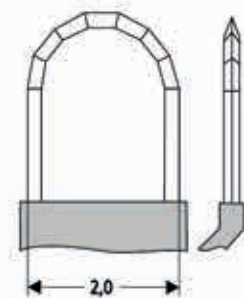

KP 371/02



MALONEY
 KP 545/02
 2,0 cm/3/4"

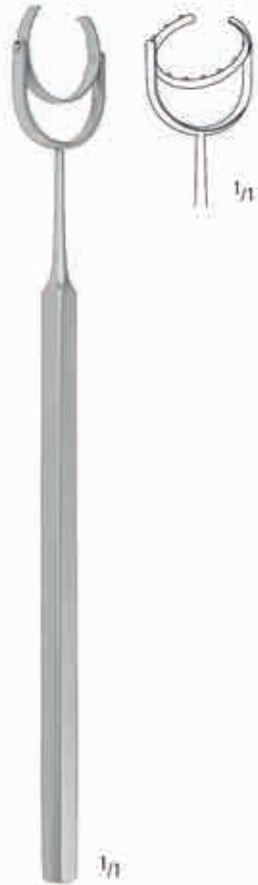

THORNTON
 KP 550/12
 12,0 cm/4 3/4"
 Ø 13 mm



BISHOP-HARMON
 KP 700/00



SAUTTER
 KP 731/27
 3,5 cm/1 1/2"
 27G

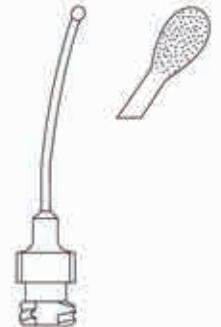

JENSEN
 KP 767/27
 4,5 cm/2"
 27G

Set komplett
 Set complete
 Juego completo
 Jeu complet
 Set completo

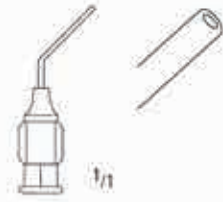

McINTYRE
 2,5 cm/1"
 KP 712/27
 27G



L(mm)	B(mm)	H(mm)	
485	255	50	SK 305/05

Contents:		Qty
AA 150/14	HALSTED-MOSQUITO ART.FCPS STR 14,0 CM	1
AA 751/15	BACKHAUS TOWEL FORCEPS 15,0 CM	2
AB 714/10	GRAEFE IRIS FORCEPS STR 1X2 TEETH 10,0 CM	1
AB 750/07	BARRAQUER-KATZIN FIX.FCPS 1X2 T. 7,0 CM	1
AB 792/11	ELSCHNIG FIXATION FORCPES 1X2 TEETH 11,0 CM	1
AB 816/10	CASTROVIEJO SUTURE FORCEPS 1.0MM 10,0 CM	1
AB 825/02	BONN SUTURE FORCEPS 10,0 CM ULRTA FINE	2
AC 431/08	MOD.BONN SCISSORS CVD 8,0 CM	1
AC 778/01	VANNAS SEC.CATARACT SCISSORS,STR. 8,0 CM	1
AC 782/11	WESTCOTT TENOTOMY SCISSORS BLUNT 11,0 CM	1
AC 785/01	CASTROVIEJO DELICATE EYE SCS.10,0 CM RIGHT	1
AC 791/01	KATZIN MICRO SCISSORS LEFT 11,0 CM	1
AC 791/02	KATZIN MICRO SCISSORS RIGHT 11,0 CM	1
AE 605/14	BARRAQUER MICRO-NEEDLE HOLDER CVD 14,0 CM	1
AE 660/14	CASTROVIEJO NH STR RA SMOOTH 14,0 CM	1
AE 688/14	KALT MICRO-NEEDLE HOLDER STR 14,0 CM	1
KP 150/15	BARRAQUER-COLIBRI EYE SPECULA 15 MM 4,0 CM	1
KP 325/05	BONN SCLERA KNIFE 5MM 12,5 CM	1
KP 370/02	PREMIUM DIAMOND KNIFE STR. 1,0 CM 45°	1
KP 508/10	BORES AXIS MARKER 10,0 CM	1
KP 535/12	ANIS SUTURE PLACEMENT MARKER 8 BLADES	1
KP 545/02	MALONEY KERATOMETER INTRAOPERATIVE 2,0 CM	1
KP 603/70	FRANCESCHETTI CERATOPLASTY TREPHINE	1
KP 603/80	FRANCESCHETTI CERATOPLASTY TREPHINE	1
KP 640/14	FLIERINGA SCLERAL FIXATION RING Ø 14,0 MM	1
KP 640/16	FLIERINGA SCLERAL FIXATION RING Ø 16,0 MM	1
KP 640/18	FLIERINGA SCLERAL FIXATION RING Ø 18,0 MM	1
KP 640/20	FLIERINGA SCLERAL FIXATION RING Ø 20,0 MM	1
KP 700/00	BISHOP-HARMON ANTERIOR CHAMBER	1
KP 731/27	SAUTTER AIR INJECTION CANNULA 27G 3,5 CM	2
SK 305/05	WIRE BASKET, 485 X 255 X 50 MM	1

Sterilization Container KYE 200/61, if required



HALSTED-MOSQUITO
AA 150/14
14,0 cm/5¹/₂"



BACKHAUS
AA 751/15
15,0 cm/6"



GRAEFE
AB 714/10
10,0 cm/4"



BARRAQUER-KATZIN 1:2 (Colibri)
AB 750/07
7,0 cm/2³/₄"



ELSCHMIG 1:2
AB 792/11
11,0 cm/4¹/₃"



CASTROVIEJO 1:2
AB 816/10
1,00 mm
10,0 cm/4"



MOD. BONN
AB 825/02
10,0 cm/4"



sehr fein
extra delicate
muy finas
très fin
molto sottile

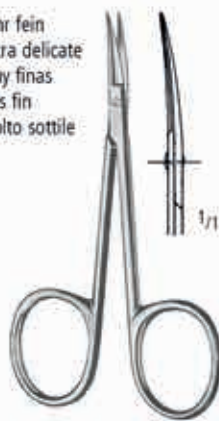

MOD. BONN
AC 431/08
8,0 cm/3"



VANNAS
AC 778/01
8,0 cm/3"



WESTCOTT
AC 782/11
11,0 cm/4¹/₃"



CASTROVIEJO
AC 785/01
10,0 cm/4"

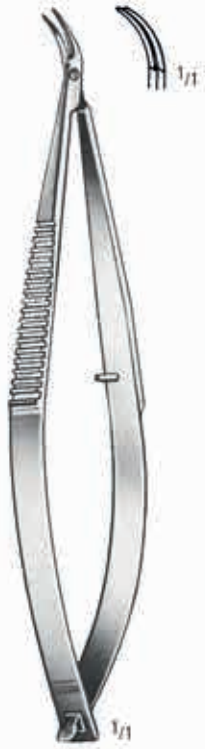

KATZIN
AC 791/01
11,0 cm/4¹/₃"



KATZIN
AC 791/02
11,0 cm/4¹/₃"



BARRAQUER
AE 605/11
11,0 cm/4¹/₃"



CASTROVIEJO
AE 660/14
14,0 cm/5¹/₂"



KALT
AE 688/14
14,0 cm/5¹/₂"



BARRAQUER-COLIBRI
B
15 mm KP 150/15
4,0 cm/1¹/₂"



BONN

KP 325/05
12,5 cm/ 5"
5 mm



KP 370/02

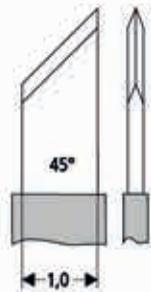

BORES
KP 508/10
10,0 cm/4"



ANIS
KP 535/12
12,0 cm/4³/₄"



MALONEY
KP 545/02
2,0 cm/3/4"



mm Ø
7,0 KP 603/70
8,0 KP 603/80
FRANCESCETTI
7,5 cm/3"

Set komplett
Set complete
Juego completo
Jeu complet
Set completo



FLIERINGA

mm Ø

14	KP 640/14
16	KP 640/16
18	KP 640/18
20	KP 640/20



BISHOP-HARMON
KP 700/00



SAUTER
KP 731/27
3,5 cm/1 1/2"
27G



L(mm)	B(mm)	H(mm)	
485	255	50	SK 305/05

Contents:

Qty

AB 750/07	BARRAQUER-KATZIN FIX.FCPS 1X2 T. 7,0 CM	1
KP 154/04	BARRAQUER PHACO EYE SPECULA 4,0 CM	1
KP 375/01	PREMIUM DIAMOND KNIFE 1,0 CM 15°	1
KP 500/70	HOFFER OPTICAL ZONE MARKER 7,0 MM 10,0 CM	1
KP 500/80	HOFFER OPTICAL ZONE MARKER 8,0 MM 10,0 CM	1
KP 508/10	BORES AXIS MARKER 10,0 CM	1
KP 515/12	LINDSTROM CORNEAL OPTICAL ZONE MARKER	1
KP 547/11	MENDEZ MEASURING INSTRUMENT DEGREE 10°C	1
KP 550/12	THORNTON FIXATION RING FG-HINGE Ø 13,0 MM	1
KP 741/23	LACRIMAL CANNULA 23G 4,0 CM CURVED	2
SK 105/05	WIRE BASKET, 255 X 245 X 50 MM	1

Sterilization Container KYE 200/11, if required



BARRAQUER-KATZIN 1:2 (Colibri)
AB 750/07
7,0 cm/2³/₄"



BARRAQUER PHAKO
KP 154/04
4,0 cm/1¹/₂"

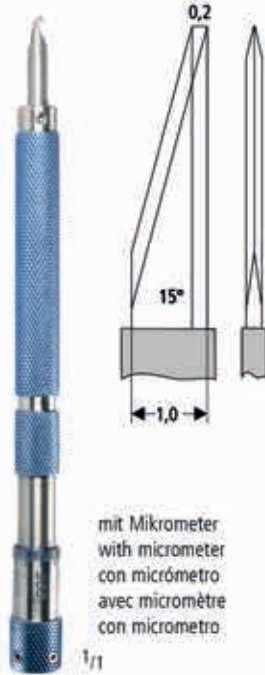

KP 375/01

mit Mikrometer
with micrometer
con micrómetro
avec micromètre
con micrometro



HOFFER
10,0 cm/4"
Ø 7,00 mm
Ø 8,00 mm

KP 500/70
KP 500/80

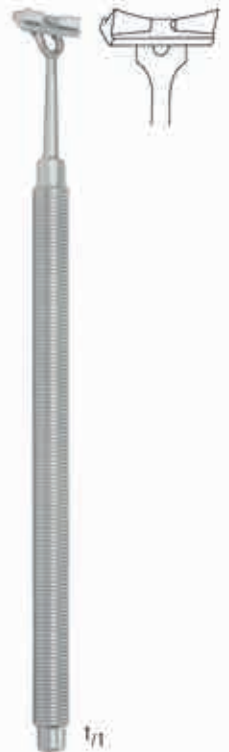

BORES
KP 508/10
10,0 cm/4"

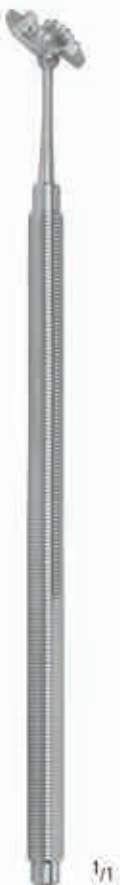

LINDSTROM
KP 515/12
12,0 cm/4³/₄"
7 mm



MENDEZ
KP 547/11
11,0 cm/4¹/₂"
C 10°, 0 -180°



THORNTON
KP 550/12
12,0 cm/4³/₄"
Ø 13 mm



KP 741/23
3,5 cm/1¹/₂"
23G



L(mm)	B(mm)	H(mm)	
255	245	50	SK 105/05

Contents:		Qty
AA 060/06	DIEFFENBACH BULLDOG CLAMPS STR 6,0 CM	2
AA 151/12	HALSTED-MOSQUITO FCPS CVD 12,5 CM	1
AA 751/08	BACKHAUS TOWEL FORCEPS 8,0 CM	2
AB 710/07	GRAEFE IRIS FORCEPS STR SERR. 7,0 CM	1
AB 714/07	GRAEFE IRIS FORCEPS STR 1X2 TEETH 700 CM	1
AB 750/07	BARRAQUER-KATZIN FIX.FCPS 1X2 T. 7,0 CM	1
AB 792/11	ELSCHNIG FIXATION FORCPES 1X2 TEETH 11,0 CM	1
AB 816/01	CASTROVIEJO SUTURE FORCEPS 0,12 MM 10,0CM	1
AB 825/02	BONN SUTURE FORCEPS 10,0 CM ULRTA FINE	1
AB 825/02	BONN SUTURE FORCEPS 10,0 CM ULRTA FINE	1
AB 828/10	PAUFIQUE SUTURE FORCEPS 1X2 TEETH 10,0 CM	1
AB 833/01	JAMESON MUSCULAR FORCEPS 10,0 CM RIGHT	1
AB 833/02	JAMESON MUSCULAR FORCEPS 10,0 CM LEFT	1
AC 461/11	STRABISMUS SCISSORS CVD BLUNT 11,5 CM	1
AC 466/10	IRIS SCISSORS STR W LARGE BOWS 10,0 CM	1
AC 768/05	BARRAQUER EYE SCISSORS 5,5 CM 5,0 MM	1
AC 780/11	WESTCOTT TENOTOMY SCS.POINTED 11,0 CM	1
AC 782/11	WESTCOTT TENOTOMY SCISSORS BLUNT 11,0 CM	1
AD 075/11	PCK=100 BLADES FIG. 11	1
AD 550/09	BLADE BREAKER 9.0 CM DIA 5,5 MM	1
AE 605/14	BARRAQUER MICRO-NEEDLE HOLDER CVD 14,0 CM	1
AE 607/14	BARRAQUER MICRO-NH CVD RA 14,0 CM	1
AE 652/09	CASTROVIEJO NH STR RA 9,0 CM	1
AR 250/15	MEASURING INSTRUMENT 15,0 CM	1
AR 282/20	CASTROVIEJO CIRCLE 8,0 CM STRAIGHT	1
KP 001/13	GREEN STRABISMUS HOOK 13,0 CM	1
KP 002/12	JAMESON MUSCLE HOOK 12,0 CM	1
KP 010/14	GASS RETINAL DETACHMENT HOOK 14,0 CM	1
KP 015/01	GRAEFE STRABISMUS HOOK #1 13,0 CM	1
KP 015/02	GRAEFE STRABISMUS HOOK #2 14,0 CM	1
KP 015/03	GRAEFE STRABISMUS HOOK #3 15,0 CM	1
KP 150/15	BARRAQUER-COLIBRI EYE SPECULA 15 MM 4,0 CM	1
KP 261/15	SAUTTER ORBITAL SPATUL MEDIUM 15,0 CM	1
KP 495/13	WECKER IRIS SPATULA 2MM SILVER 13,0 CM	1
KP 542/01	SCHIOETZ TONOMETER STRAIGHT SCALE	1
SK 305/05	WIRE BASKET, 485 X 255 X 50 MM	1

Sterilization Container KYE 200/61, if required



AA 060/06
6,0 cm/2 1/2"

DIEFFENBACH



HALSTED-MOSQUITO

AA 151/12
12,5 cm/5"



BACKHAUS

AA 751/08
8,0 cm/3"



GRAEFE

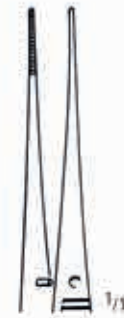

AB 710/07
7,0 cm/2 3/4"



AB 714/07
7,0 cm/2 3/4"



BARRAQUER-KATZIN 1:2 (Colibri)
AB 750/07
7,0 cm/2 3/4"



ELSCHNIG 1:2
AB 792/11
11,0 cm/4 1/3"



CASTROVIEJO 1:2
AB 816/01 0,12 mm
10,0 cm/4"



10 x
0,12 mm



MOD. BONN
AB 825/02
10,0 cm/4"



PAUFIQUE 1:2
AB 828/10
10,0 cm/4"

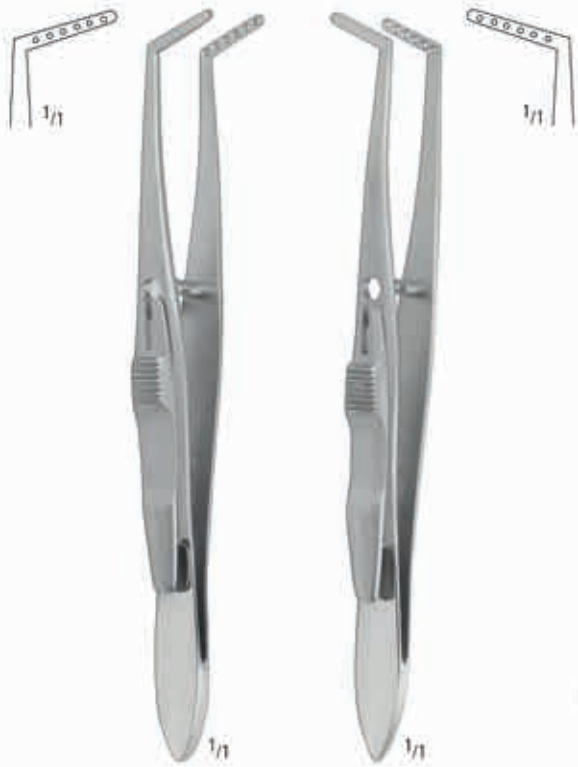

Strabismusscheren
 Strabismus Scissors
 Tijeras para estrabismos
 Ciseaux à strabisme
 Forbici per strabismo

mit großen Ringen
 with large bows
 con anillos grandes
 avec grands anneaux
 con anelli grandi

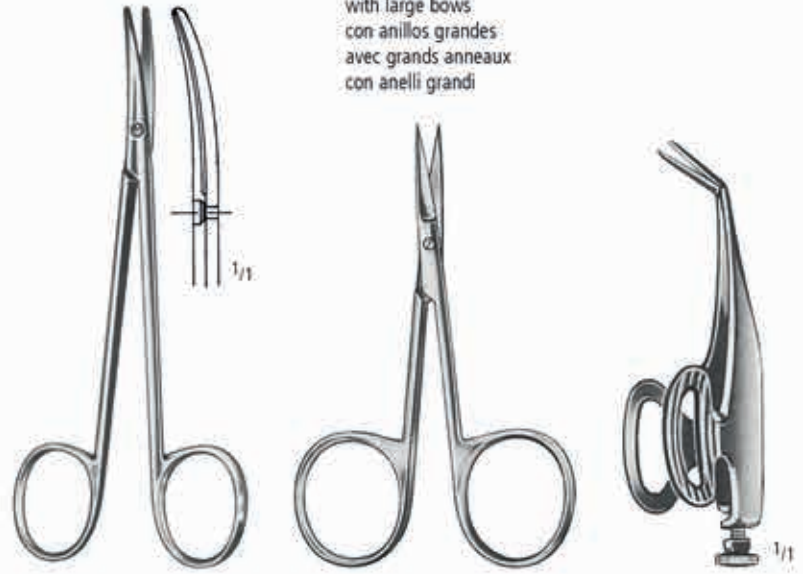

JAMESON
 AB 833/01
 10,0 cm/4"

JAMESON
 AB 833/02
 10,0 cm/4"

AC 461/11
 11,5 cm/4 1/2"

AC 466/10
 10,0 cm/4"

BARRAQUER
 5,5 cm/2 1/4"
 AC 768/05
 5 mm



Fig. 11
 AD 075/11
 steril
 sterile
 estériles
 stériles
 sterili

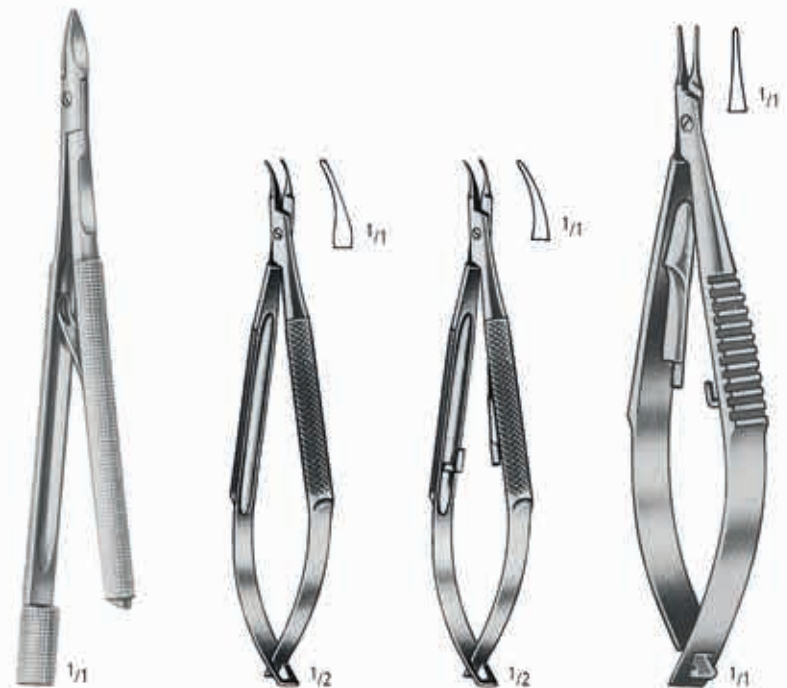

WESTCOTT
 AC 780/11
 11,0 cm/4 1/3"

WESTCOTT
 AC 782/11
 11,0 cm/4 1/3"

TROUTMAN-CHRIS
 AD 550/09
 Ø 5,5 mm
 9,0 cm/3 1/2"

BARRAQUER
 AE 605/14
 14,0 cm/5 1/2"

BARRAQUER
 AE 607/14
 14,0 cm/5 1/2"

CASTROVIEJO
 AE 652/09
 9,0 cm/3 1/2"



Messbereich 20 mm
 measuring range 20 mm
 campo de medición 20 mm
 étendue de mesurage 20 mm
 ampiezza di misura 20 mm



CASTROVIEJO
 AR 282/20
 8,0 cm/ 3"

AR 250/15
 15,0 cm/6"

Erwachsene
 Adults
 Adultos
 Adultes
 Adulti

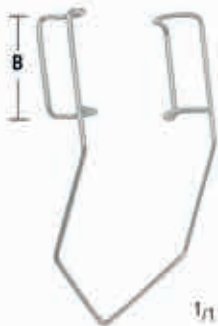

BARRAQUER-COLIBRI
B
 15 mm
 KP 150/15
 4,0 cm/1½"



GREEN
 KP 001/13
 13,0 cm/5"



JAMESON
 KP 002/12
 12,0 cm/4¾"



GASS
 KP 010/14
 14,0 cm/5½"



GRAEFE
 KP 015/01
 13,0 cm/5"
 Fig. 1



GRAEFE
 KP 015/02
 14,0 cm/5½"
 Fig. 2



GRAEFE
 KP 015/03
 15,0 cm/6"
 Fig. 3

ZS 160/55

NETZHAUTABLÖSUNG RETINAL DETACHMENT DESPRENDIMIENTO DE RETINA
DÉCOLLEMENT DE LA RÉTINE DISTACCO DELLA RETINA



SAUTER
KP 261/15
15,0 cm/6"



WECKER
KP 495/13
13,0 cm/5"
2 mm

biegsam
malleable
maleable
malléable
malleabile



gerade Skala
straight scale
graduado recto
échelle droite
scala retta

SCHIOETZ
KP 542/01
13,0 cm/5"

Spezifikation Nr. 5, geeicht
Specification No. 5, calibrated
Especificación No. 5, calibrada
Spécification No. 5, calibrée
Specifica No. 5, calibrata



L(mm)	B(mm)	H(mm)	
485	255	50	SK 305/05

Contents:		Qty
AA 150/14	HALSTED-MOSQUITO ART.FCPS STR 14,0 CM	2
AA 151/14	HALSTED-MOSQUITO ART.FCPS CVD 14,0 CM	2
AA 711/09	JONES TOWEL FORCEPS 9,0 CM	2
AB 628/09	ZIEGLER CILIA FORCEPS 9,0 CM	1
AB 785/01	GRAEFE FIX.FCPS W/O SPRING CATCH 11,0 CM	1
AB 816/01	CASTROVIEJO SUTURE FORCEPS 10,0 CM	2
AB 824/02	BONACCOLTO SUTURE FORCEPS 10,0 CM FINE	1
AB 829/01	HARMS TYING FORCEPS STRAIGHT 10,0 CM	1
AB 840/01	DESMARRES CHALAZION FORCEPS FIG.1 9,0 CM	1
AB 841/01	LAMBERT CHALAZION FORCEPS 9,0 CM ROUND	1
AB 844/20	BERKE PTOSIS FORCEPS 11,0 CM, 20 MM	1
AC 450/10	IRIS SCISSORS STR SH/SH 10,5 CM	1
AC 475/10	STEVENS TENOTOM.SCS POINTED CVD 10,5 CM	1
AC 782/11	WESTCOTT TENOTOMY SCISSORS BLUNT 11,0 CM	1
AC 797/01	WESTCOTT STRABISMUS SCS STR SHARP 11,5 CM	1
AE 663/14	CASTROVIEJO NH CVD RA SERRATED 14,0 CM	1
AE 688/14	KALT MICRO-NEEDLE HOLDER STR 14,0 CM	1
AK 074/01	GUTHRIE DELICATE HOOK FIG.1 16,0 CM	1
AK 078/13	KNAPP DELICATE HOOK BLUNT 13,0 CM	1
AK 090/12	DESMARRES RETRACTOR 12 MM 13,0 CM	1
AK 090/14	DESMARRES RETRACTOR 14 MM 13,0 CM	1
AK 090/16	DESMARRES RETRACTOR 16 MM 13,0 CM	1
AR 282/20	CASTROVIEJO CIRCLE 8,0 CM STRAIGHT	1
KP 015/01	GRAEFE STRABISMUS HOOK #1 13,0 CM	1
KP 015/02	GRAEFE STRABISMUS HOOK #2 14,0 CM	1
KP 248/11	JAEGER LID PLATE 11,0 CM	1
KP 325/05	BONN SCLERA KNIFE 5MM 12,5 CM	1
KP 415/10	MEYHOEFER CHALAZION CURETTE 13,0 CM	1
KP 415/20	MEYHOEFER CHALAZIONCURETTE 13,0 CM 2,0 MM	1
KP 415/25	MEYHOEFER CHALAZIONCURETTE 13,0 CM 2,5 MM	1
KP 415/35	MEYHOEFER CHALAZIONCURETTE 13,0 CM 3,5 MM	1
KP 700/00	BISHOP-HARMON ANTERIOR CHAMBER	1
SK 305/05	WIRE BASKET, 485 X 255 X 50 MM	1

Sterilization Container KYE 200/61, if required

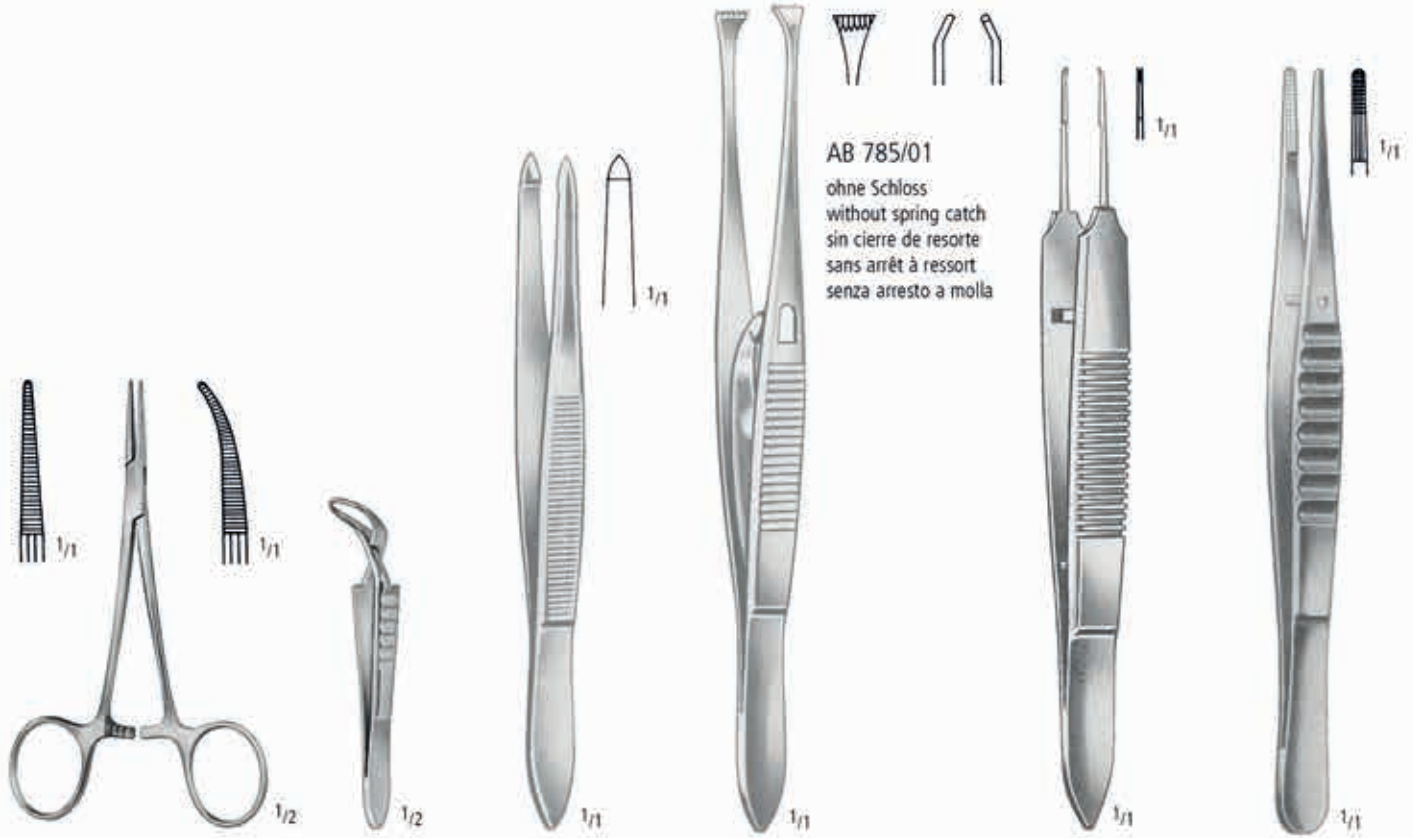

HALSTED-MOSQUITO
AA 150/14 AA 151/14
14,0 cm/5 1/2"

JONES
AA 711/09
9,0 cm/3 1/2"

ZIEGLER
AB 628/09
9,0 cm/3 1/2"

GRAEFE
11,0 cm/4 1/3"

AB 785/01
ohne Schloss
without spring catch
sin cierre de resorte
sans arrêt à ressort
senza arresto a molla

CASTROVIEJO 1:2
AB 816/01
0,12 mm
10,0 cm/4"

BONACCOLTO
AB 824/02
10,0 cm/4"



HARMS
AB 829/01
10,0 cm/4"

DESMARRES
AB 840/01
9,0 cm/3 1/2"

LAMPERT
AB 841/01
9,0 cm/3 1/2"

BERKE
AB 844/20
11,0 cm/4 1/3"
20 mm

Irisscheren
Iris Scissors
Tijeras para iridectomia
Ciseaux à iridectomie
Forbici per iridectomia

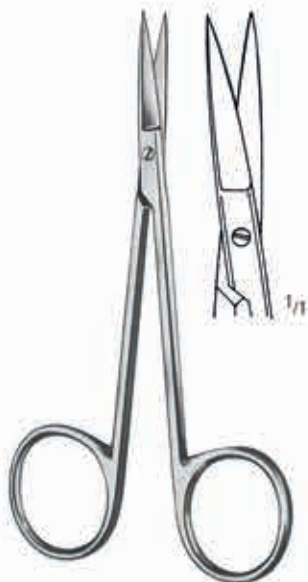

AC 450/10
10,5 cm/4 1/4"

Sehnenscheren
Tenotomy Scissors
Tijeras para tenotomia
Ciseaux à ténonomie
Forbici per tenotomia

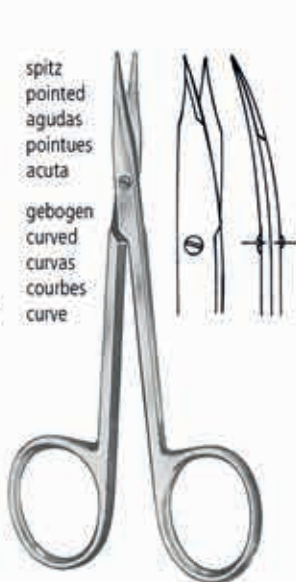

STEVENS
AC 475/10
10,5 cm/4 1/4"



WESTCOTT
AC 782/11
11,0 cm/4 1/3"



WESTCOTT
AC 797/01
11,5 cm/4 1/2"



CASTROVIEJO
AE 663/14
14,0 cm/5 1/2"



KALT
AE 688/14
14,0 cm/5 1/2"

spitz
pointed
agudas
pointues
acuta

gebogen
curved
curvas
courbes
curve

Messbereich 20 mm
measuring range 20 mm
campo de medición 20 mm
étendue de mesurage 20 mm
ampiezza di misura 20 mm



GUTHRIE
AK 074/01
16,0 cm/6 1/4"



KNAPP
AK 078/13
13,0 cm/5"



DESMARRES
13,0 cm/5"



AK 090/12
12 mm



AK 090/14
14 mm



AK 090/16
16 mm



CASTROVIEJO
AR 282/20
8,0 cm/ 3"



GRAEFE
KP 015/01
13,0 cm/5"
Fig. 1

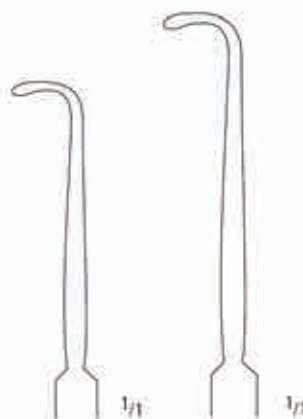

GRAEFE
KP 015/02
14,0 cm/5 1/2"
Fig. 2



JAEGER
KP 248/11
11,0 cm/4 1/2"



BONN
KP 325/05
12,5 cm/ 5"
5 mm



MEYHOEFER
13,0 cm/5"

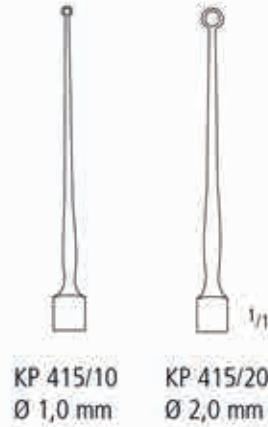

KP 415/10
Ø 1,0 mm

KP 415/20
Ø 2,0 mm

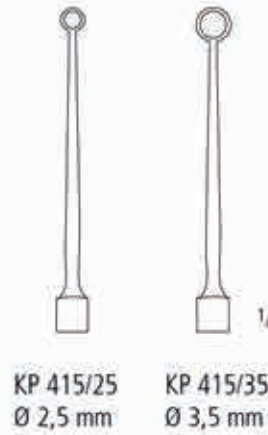

KP 415/25
Ø 2,5 mm

KP 415/35
Ø 3,5 mm

Set komplett
Set complete
Juego completo
Jeu complet
Set completo



BISHOP-HARMON
KP 700/00



L(mm)	B(mm)	H(mm)	
485	255	50	SK 305/05

ZS 160/65 PTERYGIUM PTERYGIUM PTERIGIÓN PTÉRYGION PTERIGIO

Contents:		Qty
AB 710/10	GRAEFE IRIS FORCEPS STR SERR. 10,0 CM	1
AB 714/10	GRAEFE IRIS FORCEPS STR 1X2 TEETH 10,0 CM	1
AB 786/02	GREEN FIXATION FORCEPS T-FORM 10,0 CM	1
AB 828/10	PAUFIQUE SUTURE FORCEPS 1X2 TEETH 10,0 CM	1
AC 466/10	IRIS SCISSORS STR W LARGE BOWS 10,0 CM	1
AE 657/14	CASTROVIEJO NH CVD SMOOTH 14,0 CM	1
AK 090/10	DESMARRES RETRACTOR 10 MM 13,0 CM	1
KP 186/08	LANCASTER EYE SPECULA 8,0 CM	1
KP 325/05	BONN SCLERA KNIFE 5MM 12,5 CM	1
SK 105/05	WIRE BASKET, 255 X 245 X 50 MM	

Sterilization Container KYE 200/11, if required



AB 710/10
10,0 cm/4"



AB 714/10
10,0 cm/4"

GRAEFE

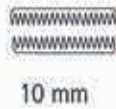

GREEN
AB 786/02
10,0 cm/4"



PAUFIQUE 1:2
AB 828/10
10,0 cm/4"

mit großen Ringen
with large bows
con anillos grandes
avec grands anneaux
con anelli grandi



AC 466/10
10,0 cm/4"



CASTROVIEJO
AE 657/14
14,0 cm/5 1/2"



DESMARRES
AK 090/10
13,0 cm/5"



LANCASTER
KP 186/08
8,0 cm/3 1/4"

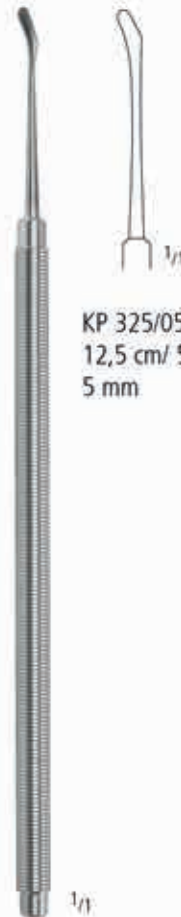

KP 325/05
12,5 cm/ 5"
5 mm

BONN



L(mm)	B(mm)	H(mm)	
255	245	50	SK 105/05

Contents:

Qty

AA 114/10	HARTMANN FORCEPS STR 10,0 CM	2
AA 115/10	HARTMANN FORCEPS CVD 10,0 CM	2
AA 751/08	BACKHAUS TOWEL FORCEPS 8,0 CM	2
AB 700/05	GRAEFE IRIS FCPS STR.SERRAT. 0,5 MM 7,0 CM	1
AB 816/01	CASTROVIEJO SUTURE FORCEPS 0,12MM 10,0 CM	1
AB 824/02	BONACCOLTO SUTURE FORCEPS 10,0 CM FINE	1
AB 828/10	PAUFIQUE SUTURE FORCEPS 1X2 TEETH 10,0 CM	1
AC 466/10	IRIS SCISSORS STR W LARGE BOWS 10,0 CM	1
AC 477/10	STEVENS TENOTOM.SCS BLUNT CVD 10,5 CM	1
AC 773/10	CASTROVIEJO IRIS SCISSORS 10,0 CM SH	1
AE 661/14	CASTROVIEJO NH CVD RA SMOOTH 14,0 CM	1
AK 077/13	KNAPP DELICATE HOOK SHARP 13,0 CM	1
KA 540/32	MEAD MALLETT 320GR MASSIV FERROZ.FAC.17,0 CM	1
KA 800/14	FRIEDMANN RONGEUR FORCEPS 14,0 CM	1
KO 050/01	HARTMANN-HALLE NASAL SPEC.15,0 CM FIG.1	1
KO 275/90	KERRISON ANTRUM RONGEUR FCPS 3X3 MM	1
KO 343/16	JOSEPH SEPTUM ELEVATOR 16,0 CM	1
KO 603/04	FREER CHISELS CURVED 16,0 CM	1
KO 604/04	WEST CHISELS 16,0 CM	1
KO 605/04	WEST GOUGES 16,0 CM	1
KP 114/00	BOWMAN LACRIMAL PROBE POINTED 12,5 CM	1
KP 115/00	BOWMAN LACRIMAL PROBE POINTED 12,5 CM	1
KP 115/12	BOWMAN LACRIMAL PROBE POINTED 12,5 CM	1
KP 115/34	BOWMAN LACRIMAL PROBE POINTED 12,5 CM	1
KP 115/56	BOWMAN LACRIMAL PROBE POINTED 12,5 CM	1
KP 123/14	CASTROVIEJO LACRIMAL DILATOR,14,0 CM D/E	1
KP 135/14	WORST PIGTAIL PROBE 13,5 CM	1
KP 230/08	STEVENS LACRIMAL SAC RETRACTOR 7,5 CM	1
KP 700/00	BISHOP-HARMON ANTERIOR CHAMBER	1
KP 740/23	ANEL LACRIMAL CANNULA 23G 4,0 CM	1
KP 741/23	LACRIMAL CANNULA 23G 4,0 CM CURVED	1
SK 305/05	WIRE BASKET, 485 X 255 X 50 MM	1

Sterilization Container KYE 200/61, if required



HARTMANN
AA 114/10
10,0 cm/4"



HARTMANN
AA 115/10
10,0 cm/4"



BACKHAUS
AA 751/08
8,0 cm/3"



GRAEFE
0,5 mm
AB 700/05
7,0 cm/2³/₄"



CASTROVIEJO 1:2
AB 816/01
0,12 mm
10,0 cm/4"



BONACCOLTO
AB 824/02
10,0 cm/4"



PAUFIGUE 1:2
AB 828/10
10,0 cm/4"



AC 466/10
10,0 cm/4"

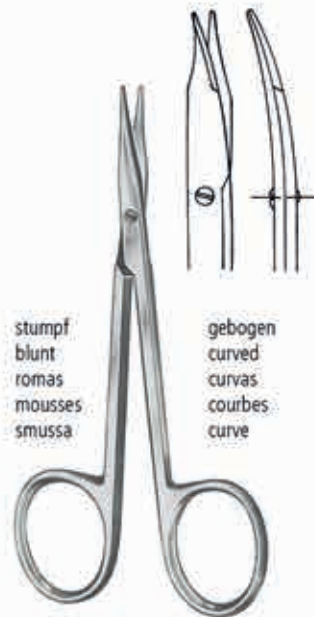

STEVENS
AC 477/10
10,5 cm/4¹/₄"



CASTROVIEJO
10,0 cm/4"

ZS 160/70

DACRYOCYSTORHINOSTOMIE
DACRYOCYSTORHINOSTOMIE

DACRYOCYSTORHINOSTOMY
DACRYOCYSTORHINOSTOMIA

DACRIOCISTORINOSTOMIA



CASTROVIEJO
AE 661/14
14,0 cm/5½"



KNAPP
AK 077/13
13,0 cm/5"



MEAD
KA 540/32
17,0 cm/6¾"



FRIEDMAN
KA 800/14
14,0 cm/5½"



HARTMANN-HALLE
KO 050/01
15,0 cm/6"



KERRISON



JOSEPH
KO 343/16
16,0 cm/6¼"



FREER
KO 603/04
16,0 cm/6¼"



WEST
KO 604/04
16,0 cm/6¼"



WEST
KO 605/04
16,0 cm/6¼"



geknöpft
pointed
con botón
boutonné
bottenuto

aus Silber
Sterling silver
de plata pura
en argent pur
in argento puro

	Fig.	mm Ø
KP 114/00	0000/00	0,4 / 0,6
KP 115/00	00/0	0,7 / 0,8
KP 115/12	1/2	0,9 / 1,1
KP 115/34	3/4	1,3 / 1,4
KP 115/56	5/6	1,5 / 1,6

BOWMAN
12,5 cm/5"



CASTROVIEJO
KP 123/14
14 cm/5 1/2"

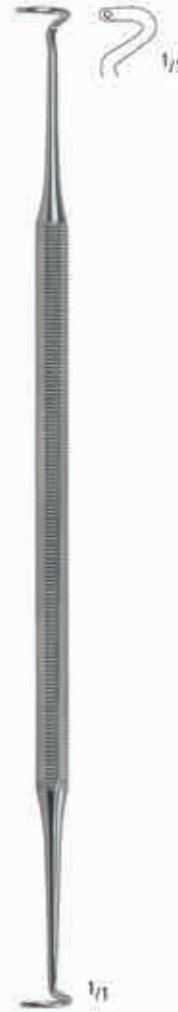

WORST
KP 135/14
13,5 cm/5 1/4"



STEVENSON
KP 230/08
7,5 cm/3"



BISHOP-HARMON
KP 700/00

Set komplett
Set complete
Juego completo
Jeu complet
Set completo



ANEL
KP 740/23
4,0 cm/1 1/2"
23G



KP 741/23
3,5 cm/1 1/2"
23G



L(mm)	B(mm)	H(mm)	
485	255	50	SK 305/05

Contents:		Qty
AB 819/02	MCPHERSON TYING FORCEPS ANGLED 10,5 CM	1
KP 210/02	LIEBERMAN EYE SPECULA 15 MM K-SHAPE 8,0 CM	1
KP 211/08	LIEBERMAN EYE SPECULA 15 MM 8,0 CM ASP.	1
KP 270/10	LASIK FLAP SMOOTHER 10,0 CM	1
KP 487/14	CASTROVIEJO CYCLODIALYSIS SPATULA 13,5 CM	1
KP 489/12	BARRAQUER-FINO CYCLODIALYSIS SPATULA 11,5 CM	1
KP 516/11	LU CORNEAL MARKER LASIK Ø 8,5MM 10,5 CM	1
KP 550/12	THORNTON FIXATION RING FG-HINGE Ø 13,0 MM	1
KP 701/19	BISHOP-HARMON IRRIGATION CANNULA 19G 4,0 CM	1
KP 731/27	SAUTTER AIR INJECTION CANNULA 27G 3,5 CM	1
SK 105/05	WIRE BASKET, 255 X 245 X 50 MM	1

Sterilization Container KYE 200/11, if required



McPHERSON
AB 819/02
10,0 cm/4"



LIEBERMAN
KP 210/02
8,0 cm/3¹/₄"
B = 15 mm



LIEBERMAN
KP 211/08
8,0 cm/3¹/₄"
B = 15 mm



LASIK
KP 270/10
10,0 cm/4"

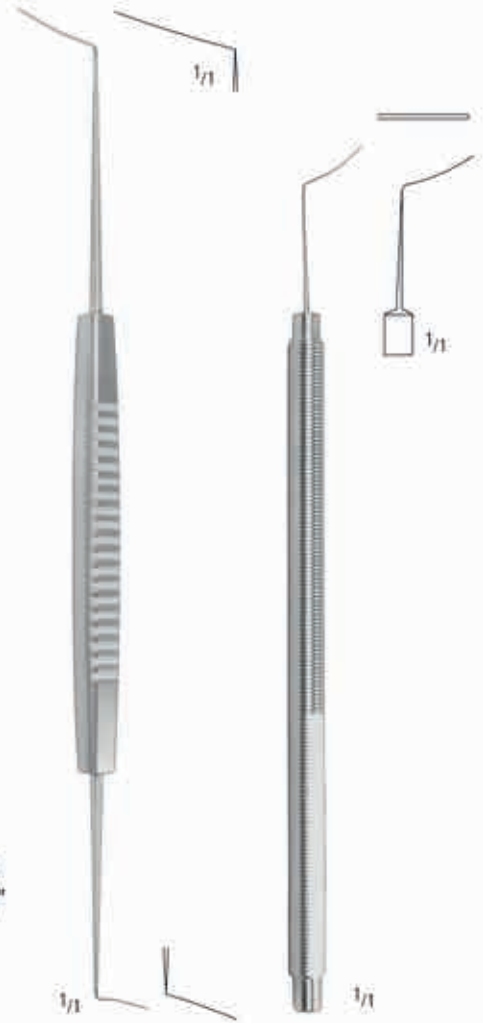

CASTROVIEJO
KP 487/14
13,5 cm/5¹/₄"
0,5 x 10/16 mm

BARRAQUER-FINO
KP 489/12
11,5 cm/4¹/₂"
0,25 x 12 mm



LU
KP 516/11
10,5 cm/4¹/₄"
Ø 8,5 mm

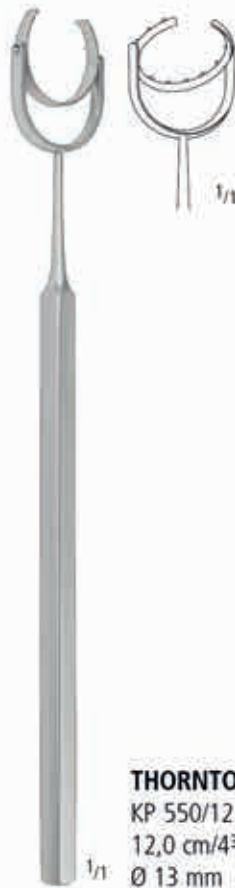

THORNTON
KP 550/12
12,0 cm/4³/₄"
Ø 13 mm

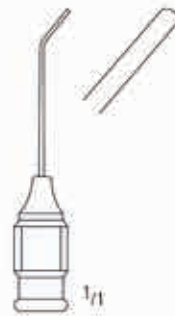

BISHOP-HARMON
KP 701/19
4,0 cm/1¹/₂"
19G



SAUTTER
KP 731/27
3,5 cm/1¹/₂"
27G



L(mm)	B(mm)	H(mm)	
255	245	50	SK 105/05

Contents:

Qty

AB 752/07	BARRAQUER-KATZIN IRIS FORCEPS 7,0 CM	1
AB 820/10	KELMAN-MCPHERSON TYING FORCEPS 10,0 CM	1
KP 154/04	BARRAQUER PHACO EYE SPECULA 4,0 CM	1
KP 375/02	PREMIUM DIAMOND KNIFE 1,0 CM 45°	1
KP 500/30	HOFFER OPTICAL ZONE MARKER 3,00 MM 10,0 CM	1
KP 500/32	HOFFER OPTICAL ZONE MARKER 3,25 MM 10,0 CM	1
KP 500/40	HOFFER OPTICAL ZONE MARKER 4.00 MM 10,0 CM	1
KP 500/50	HOFFER OPTICAL ZONE MARKER 5.00MM 10,0 CM	1
KP 500/70	HOFFER OPTICAL ZONE MARKER 7.00MM 10,0 CM	1
KP 535/12	ANIS SUTURE PLACEMENT MARKER 8 BLADES	1
KP 548/50	DEITZ DEPTH GAUGE 0,50 MM 9,5 CM	1
KP 548/55	DEITZ DEPTH GAUGE 0,55 MM 9,5 CM	1
KP 550/12	THORNTON FIXATION RING FG-HINGE Ø 13,0 MM	1
KP 731/27	SAUTTER AIR INJECTION CANNULA 27G 3,5 CM	2
SK 105/05	WIRE BASKET, 255 X 245 X 50 MM	1

Sterilization Container KYE 200/11, if required



BARRAQUER-KATZIN 1:2
(Colibri)
AB 752/07
7,0 cm/2³/₄"



BARRAQUER PHAKO
KP 154/04
4,0 cm/1¹/₂"



mit Mikrometer
with micrometer
con micrómetro
avec micromètre
con micrometro

- Ø 3,00 mm
- Ø 3,25 mm
- Ø 4,00 mm
- Ø 5,00 mm
- Ø 7,00 mm



HOFFER
10,0 cm/4"

KELMAN-McPHERSON 1:2
AB 820/10
10,0 cm/4"

KP 375/02



ANIS
KP 535/12
12,0 cm/4³/₄"



DEITZ
9,5 cm/3³/₄"
KP 548/50 0,50 mm
KP 548/55 0,55 mm



THORNTON
KP 550/12
12,0 cm/4³/₄"
Ø 13 mm



SAUTTER
KP 731/27
3,5 cm/1¹/₂"
27G



L(mm)	B(mm)	H(mm)	
255	245	50	SK 105/05

Contents:		Qty
AA 060/03	DIEFFENBACH BULLDOG CLAMPS STR 3,5 CM	2
AA 114/10	HARTMANN FORCEPS STR 10,0 CM	2
AA 150/12	HALSTED-MOSQUITO FCPS STR 12,5 CM	2
AA 711/09	JONES TOWEL FORCEPS 9,0 CM	2
AA 751/13	BACKHAUS TOWEL FORCEPS 13,0 CM	2
AB 710/10	GRAEFE IRIS FORCEPS STR SERR. 10,0 CM	1
AB 750/07	BARRAQUER-KATZIN FIX.FCPS 1X2 T. 7,0 CM	1
AB 816/01	CASTROVIEJO SUTURE FORCEPS 10,0 CM	2
AB 824/02	BONACCOLTO SUTURE FORCEPS 10,0 CM FINE	1
AB 825/02	BONN SUTURE FORCEPS 10,0 CM ULRTA FINE	2
AB 848/11	FAULKNER LENS HOLDING FORCEPS 11,0 CM	1
AC 466/10	IRIS SCISSORS STR W LARGE BOWS 10,0 CM	1
AC 467/10	IRIS SCISSORS CVD W LARGE BOWS 10,0 CM	1
AC 474/11	STEVENS TENOTOM.SCS.STR POINTED 11,5 CM	1
AC 776/01	VANNAS MOD.TÜBINGEN STRAIGHT 8,5 CM	1
AC 780/11	WESTCOTT TENOTOMY SCS.POINTED 11,0 CM	1
AE 657/14	CASTROVIEJO NH CVD SMOOTH 14,0 CM	1
AE 660/14	CASTROVIEJO NH STR RA SMOOTH 14,0 CM	1
AR 282/20	CASTROVIEJO CIRCLE 8,0 CM STRAIGHT	1
KP 002/12	JAMESON MUSCLE HOOK 12,0 CM	2
KP 010/14	GASS RETINAL DETACHMENT HOOK 14,0 CM	2
KP 211/08	LIEBERMAN EYE SPECULA 15 MM 8,0 CM ASP.	1
KP 261/15	SAUTTER ORBITAL SPATUL MEDIUM 15,0 CM	1
KP 262/13	ARRUGA PROTECTOR 13,0 CM	1
KP 354/12	FOREIGN BODY NEEDLE STRAIGHT 12,0 CM	1
KP 390/00	VITRECTOMY SCISSORS STRAIGHT SMOOTH 0°	1
KP 394/00	VITRECTOMY GRASPING FCPS STRAIGHT SMOOTH	1
KP 700/00	BISHOP-HARMON ANTERIOR CHAMBER	1
KP 760/21	INJECTION CANNULA 21G 4,5 CM	1
SK 305/05	WIRE BASKET, 485 X 255 X 50 MM	1

Sterilization Container KYE 200/61, if required



DIEFFENBACH
AA 060/03
3,5 cm/1 1/2"



HARTMANN
AA 114/10
10,0 cm/4"



HALSTED-MOSQUITO
AA 150/12
12,5 cm/5"



JONES
AA 711/09
9,0 cm/3 1/2"

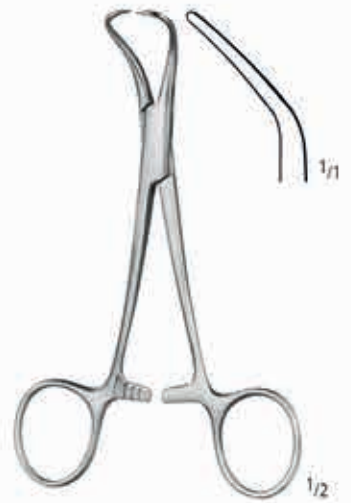

BACKHAUS
AA 751/13
13,0 cm/5"



GRAEFE
AB 710/10
10,0 cm/4"



**BARRAQUER-KATZIN 1:2
(Colibri)**
AB 750/07
7,0 cm/2 3/4"



CASTROVIEJO 1:2
AB 816/01
0,12 mm
10,0 cm/4"



BONACCOLTO
AB 824/02
10,0 cm/4"



MOD. BONN
AB 825/02
10,0 cm/4"



FAULKNER
AB 848/11
11,0 cm/4 1/3"

ZS 160/85

VITREKTOMIE (PARS PLANA)
VITRECTOMIE (PARS PLANA)

VITRECTOMY (PARS PLANA)
VITRECTOMIA PARS-PLANA

VITRECTOMIA PARS-PLANA

mit großen Ringen
with large bows
con anillos grandes
avec grands anneaux
con anelli grandi



AC 467/10
10,0 cm/4"

AC 466/10
10,0 cm/4"

spitz
pointed
agudas
pointues
acuta

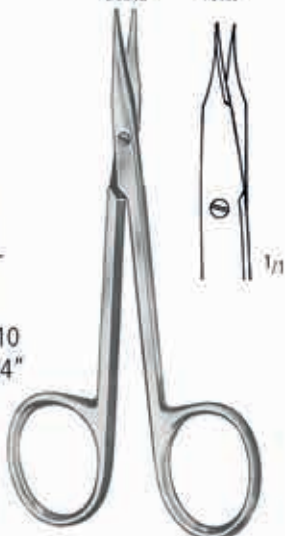

STEVENS
AC 474/11
11,5 cm/4 1/2"

gerade
straight
rectas
droits
rette

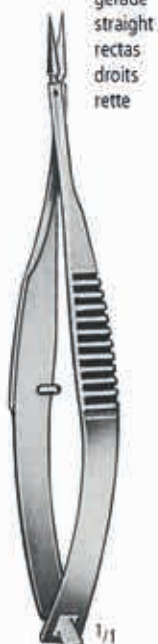

VANNAS MOD.
TÜBINGEN
AC 776/01
8,5 cm/3 1/3"



WESTCOTT
AC 780/11
11,0 cm/4 1/3"



CASTROVIEJO
AE 657/14
14,0 cm/5 1/2"



CASTROVIEJO
AE 660/14
14,0 cm/5 1/2"

Messbereich 20 mm
measuring range 20 mm
campo de medición 20 mm
étendue de mesure 20 mm
ampiezza di misura 20 mm



CASTROVIEJO
AR 282/20
8,0 cm/ 3"



JAMESON
KP 002/12
12,0 cm/4 3/4"



GASS
KP 010/14
14,0 cm/5 1/2"



LIEBERMAN
KP 211/08
8,0 cm/3 1/4"
B = 15 mm

ZS 160/85

VITREKTOMIE (PARS PLANA)
VITRECTOMIE (PARS PLANA)

VITRECTOMY (PARS PLANA)
VITRECTOMIA PARS-PLANA

VITRECTOMÍA PARS-PLANA



SAUTER
KP 261/15
15,0 cm/6"



ARRUGA
KP 262/13
13,0 cm/5"



KP 354/12
12,0 cm/ 4¾"



KP 390/00
0°



KP 394/00

ohne Spülung
without irrigation
sin irrigación
sans irrigation
senza irrigazione



BISHOP-HARMON
KP 700/00

Set komplett
Set complete
Juego completo
Jeu complet
Set completo

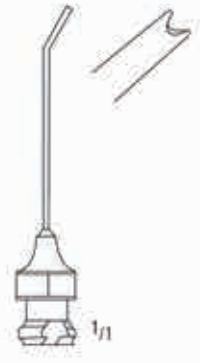

KP 760/21
4,5 cm/2"
21G

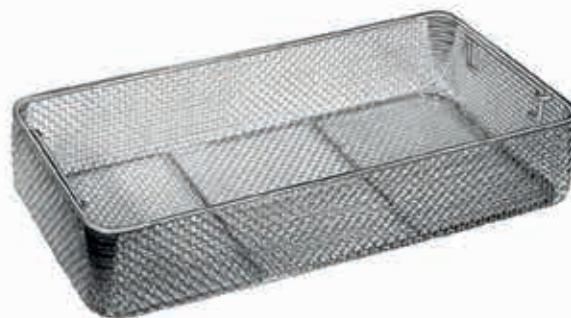

L(mm)	B(mm)	H(mm)	
485	255	50	SK 305/05

KLEMMEN
HEMOSTATS
PINZAS HEMOSTATICAS
PINCES HEMOSTATIQUES
PINZE EMOSTATICHE

AA

nopa[®] instruments

Weitere Klemmen finden Sie in unserem Katalog „Allgemeines Instrumentarium“ in Gruppe AA.

For further hemostats kindly refer to our catalogue „General Instruments“, section AA.

Para pinzas hemostaticas adicionales, por favor consulte nuestro catálogo de „Instrumental de uso general“, grupo AA.

Pour des pinces hemostatiques supplémentaires, consultez notre catalogue „Instrumentation Generale“, section AA.

Per gli altri pinze emostatiche, consultare il nostro catalogo „Strumentazione Generale“, gruppo AA.



Bulldogklemmen, Anlegezangen
 Bulldog Clamps, Setting Forceps
 Clamps Bulldog, Pinza para poner
 Clamps Bulldog, Pinze à poser
 Pinze Bulldog, Pinza per posizionare



DIEFFENBACH



AA 060/03
3,5 cm/1 1/2"



AA 060/05
5,0 cm/2"



AA 060/06
6,0 cm/2 1/2"



AA 061/03
3,5 cm/1 1/2"



AA 061/05
5,0 cm/2"



AA 061/06
6,0 cm/2 1/2"



JOHNS-HOPKINS
 AA 069/24
 24,5 cm/9 3/4"



JOHNS-HOPKINS



AA 070/04
4,0 cm/1 1/2"



AA 070/05
5,0 cm/2"



AA 070/06
6,5 cm/2 1/2"



AA 070/07
7,5 cm/3"



AA 070/09
9,0 cm/3 1/2"



AA 071/04
4,0 cm/1 1/2"



AA 071/05
5,0 cm/2"



AA 071/06
6,5 cm/2 1/2"



AA 071/07
7,5 cm/3"



AA 071/09
9,0 cm/3 1/2"

Arterienklemmen
 Artery Forceps
 Pinzas hemostáticas
 Pincas hémostatiques
 Pinze emostatiche

T = TITAN



HARTMANN
 AA 114/10
 AA 114/10 T
 10,0 cm/4"



HARTMANN
 AA 115/10
 AA 115/10 T
 10,0 cm/4"

WILLIAM STEWART HALSTED
 was professor of surgery in the Johns Hopkins University.
 In 1890 he had bronze casts made of his own hands. On these casts the first surgical rubber gloves were moulded.



HALSTED-MOSQUITO
 AA 150/12 AA 151/12
 AA 150/12 T AA 151/12 T
 AA 150/14 AA 151/14

12,5 cm/5"
 12,5 cm/5"
 14,0 cm/5½"

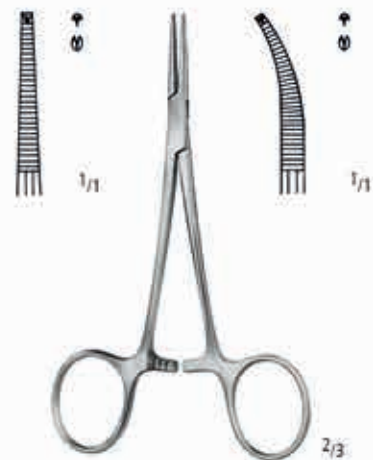

HALSTED-MOSQUITO 1:2
 AA 152/12 AA 153/12
 AA 152/12 T AA 153/12 T
 AA 152/14 AA 153/14

Tuchklemmen
Towel Forceps
Pinzas para compresas, Pinzas de campo
Pincés à champs, Pincés à compresas
Pinze per fissare le compresse (Fissarele)



SCHAEDEL
AA 710/09
9,0 cm/3 1/2"



JONES
5,0 cm/2"
9,0 cm/3 1/2"
AA 711/05
AA 711/09



AA 749/11
11,0 cm/4 1/2"

mit Schlauch- oder Kabelhalter
with clip for tubing or cable
con porta-tubo o porta-cable
avec clamp porte-tube ou porte-
-cordon d'alimentation
con porta tubo o porta cavo

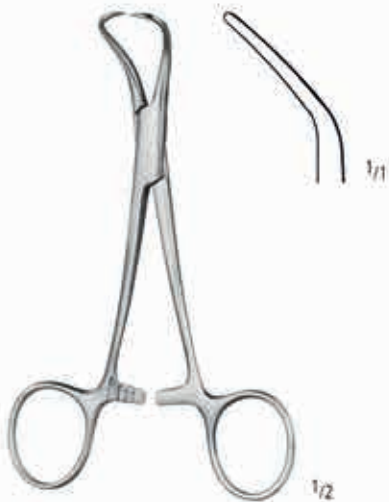

BACKHAUS
8,0 cm/3 1/4" AA 751/08
11,0 cm/4 1/2" AA 751/11
13,0 cm/5" AA 751/13
15,0 cm/6" AA 751/15



ROEDER
13,0 cm/5" AA 761/13
15,0 cm/6" AA 761/15

AA

AB

AC

AD

AE

AK

AR

KA

KM

KD

XP

XR

Tuchklemmen
Towel Forceps
Pinzas para compresas, Pinzas de campo
Pinces à champs, Pinces à compresses
Pinze per fissare le compresse (Fissarele)



LORNA

10,0 cm/4" AA 763/10
13,0 cm/5" AA 763/13



TOHOKU-JAPAN

10,0 cm/4" AA 764/10
13,0 cm/5" AA 764/13



für Papiertücher
for paper tissues
para servilletas de papel
pour serviettes en papier
per tessuti di carta

PEERS

AA 765/14
14,5 cm/5³/₄"

PINZETTEN
FORCEPS
PINZAS
PINCES
PINZE

AB

nopa[®] instruments

Weitere Pinzetten finden Sie in unserem Katalog „Allgemeines Instrumentarium“ in Gruppe AB.

For further forceps kindly refer to our catalogue „General Instruments“, section AB.

Para pinzas adicionales, por favor consulte nuestro catálogo de „Instrumental de uso general“, grupo AB.

Pour des pinces supplémentaires, consultez notre catalogue „Instrumentation Generale“, section AB.

Per gli altri pinze, consultare il nostro catalogo „Strumentazione Generale“, gruppo AB.



Anatomische Pinzetten, Chirurgische Pinzetten
 Dressing Forceps, Tissue Forceps
 Pinzas de disección, Pinzas de disección con dientes
 Pincers à dissection, Pincers a griffes
 Pinze anatomiche per dissezione, Pinze chirurgiche a denti di topo

T = TITAN



AB 100/12

1/2



AB 102/12

1/2



AB 110/12

1/2



AB 112/12

1/2

12,0 cm/4³/₄"
 12,0 cm/4³/₄"
 15,0 cm/6"

ADSON
 AB 100/12
 AB 100/12 T
 AB 100/15

MICRO-ADSON
 AB 102/12
 AB 102/15

ADSON 1:2
 AB 110/12
 AB 110/12 T
 AB 110/15

MICRO-ADSON 1:2
 AB 112/12
 AB 112/15



7 : 7
 AB 116/07
 AB 116/07 T

9 : 9
 AB 116/09

ADSON-BROWN

12,0 cm/4³/₄"



9 : 9

ADSON-BROWN

AB 117/09
 12,0 cm/4³/₄"

PINZETTEN FORCEPS PINZAS PINCES PINZE

Cilienpinzetten
Cilia Forceps
Pinzas de depilatorias
Pincas à épiler les cils
Pinze depilatorie



LITTAUER
AB 620/08
8,5 cm/3 1/2"



AB 621/09
9,0 cm/3 1/2"



DOUGLAS
AB 624/09
9,0 cm/3 1/2"



BEER
AB 626/09
9,0 cm/3 1/2"



ZIEGLER
AB 628/09
9,0 cm/3 1/2"



BARRAQUER
AB 633/10
10,5 cm/4 1/4"



GRADLE
AB 635/09
9,5 cm/3 3/4"

AA
AB
AC
AD
AE
AK
AR
KA
KM
KO
KP
XR

AB PINZETTEN FORCEPS PINZAS PINCES PINZE

Irispinzetten
Iris Forceps
Pinzas para iris
Pincès à iris
Pinze per iride



AB 700/07

GRAEFE
7,0 cm/2³/₄"

- 0,5 mm AB 700/05
- 0,7 mm AB 700/07
- 1,0 mm AB 700/10



AB 701/07

GRAEFE
7,0 cm/2³/₄"

- AB 701/05
- AB 701/07
- AB 701/10



AB 702/07

GRAEFE 1:2
7,0 cm/2³/₄"

- AB 702/05
- AB 702/07
- AB 702/10



AB 703/07

GRAEFE 1:2
7,0 cm/2³/₄"

- AB 703/05
- AB 703/07
- AB 703/10



GRAEFE



7,0 cm/2³/₄" AB 710/07
10,0 cm/4" AB 710/10



AB 711/07
AB 711/10



AB 713/07
AB 713/10



AB 714/07
AB 714/10



AB 715/07
AB 715/10

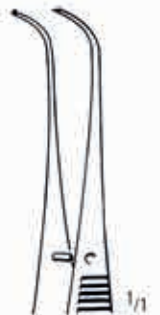

AB 717/07
AB 717/10

PINZETTEN FORCEPS PINZAS PINCES PINZE

Irispinzetten
Iris Forceps
Pinzas para iris
Pincès à iris
Pinze per iride



STEVENS 1:2
AB 718/01
11,0 cm/4¹/₂"



STEVENS 1:2
AB 718/02
11,0 cm/4¹/₂"



STEVENS
10,5 cm/4¹/₂"



AB 720/01



AB 720/02



AB 720/03



AB 721/01 1:2



AB 721/02 1:2



AB 721/03 1:2



FISCHER-ARLT 1:2
AB 723/07
7,0 cm/2³/₄"

AA

AB

AC

AD

AE

AK

AR

KA

KM

KD

XP

XR

AB PINZETTEN FORCEPS PINZAS PINCES PINZE

Irispinzetten
Iris Forceps
Pinzas para iris
Pincès à iris
Pinze per iride



FOERSTER
AB 726/08
8,5 cm/3 1/2"



FOERSTER
AB 727/08
8,5 cm/3 1/2"



FOERSTER 1:2
AB 728/08
8,5 cm/3 1/2"



FOERSTER 1:2
AB 729/08
8,5 cm/3 1/2"



HESS 1:2
AB 730/07
7,0 cm/2 3/4"



HESS 1:2
AB 731/09
9,0 cm/3 1/2"



MOD. BONN 1:2
AB 734/01
7,0 cm/2 3/4"



MOD. BONN 1:2
AB 734/02
7,0 cm/2 3/4"

PINZETTEN FORCEPS PINZAS PINCES PINZE

Irispinzetten
Iris Forceps
Pinzas para iris
Pincès à iris
Pinze per iride

AA

AB

AC

AD

AE

AK

AR

KA

KM

KO

XP

XR



MOD. BONN
7,0 cm/2³/₄"

AB 735/01

AB 735/02



BISHOP-HARMON
8,5 cm/3¹/₂"

AB 736/08

AB 738/08



BISHOP-HARMON
8,5 cm/3¹/₂"

AB 740/08



AB 742/08



KIRBY 1:2
AB 748/09
9,0 cm/3¹/₂"



BARRAQUER-KATZIN 1:2
(Colibri)
AB 750/07
7,0 cm/2³/₄"

AB PINZETTEN FORCEPS PINZAS PINCES PINZE

Irispinzetten, Kapselpinzetten
 Iris Forceps, Capsular Forceps
 Pinzas para iris, Pinzas capsulares
 Pincès à iris, Pincès capsulaires
 Pinze per iride, Pinze capsulari



10 x

TROUTMAN 1:2
(Corneal)
 AB 751/07
 7,5 cm/3"



10 x

BARRAQUER-KATZIN 1:2
(Colibri)
 AB 752/07
 7,0 cm/2³/₄"



AB 756/07

Zähne seitwärts
 teeth on side
 dientes laterales
 dents latérales
 denti laterali



AB 757/07

Zähne unten
 teeth below
 dientes inferiores
 dents en bas
 denti in basso



GILL-HESS 1:2
 7,5 cm/3"



10 x

0,3 mm

GILL 1:2
 AB 762/07
 7,5 cm/3"



GILL-FUCHS
 AB 763/07
 7,5 cm/3"



TERSON
 AB 765/09
 9,0 cm/3¹/₂"



CASTROVIEJO
 AB 767/01
 10,0 cm/4"



CASTROVIEJO
 AB 767/02
 10,0 cm/4"

PINZETTEN FORCEPS PINZAS PINCES PINZE

Kapselpinzetten, Fixierpinzetten
 Capsular Forceps, Fixation Forceps
 Pinzas capsulares, Pinzas de fijación
 Pincas capsulaires, Pincas à fixer
 Pinze capsulari, Pinze fissatrici

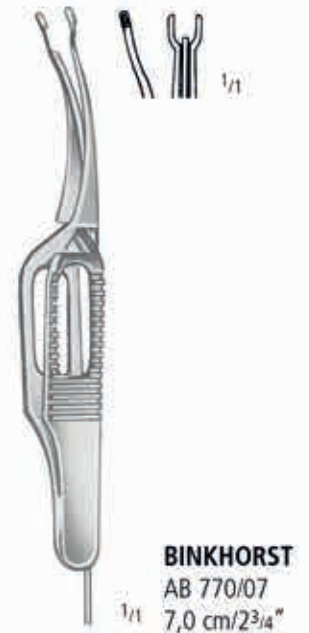
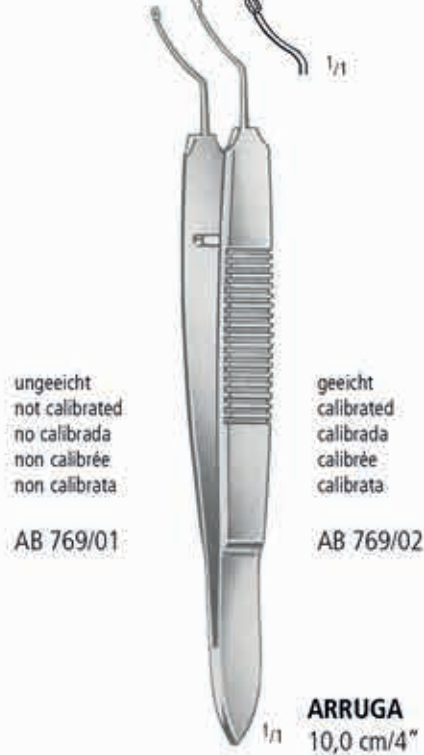
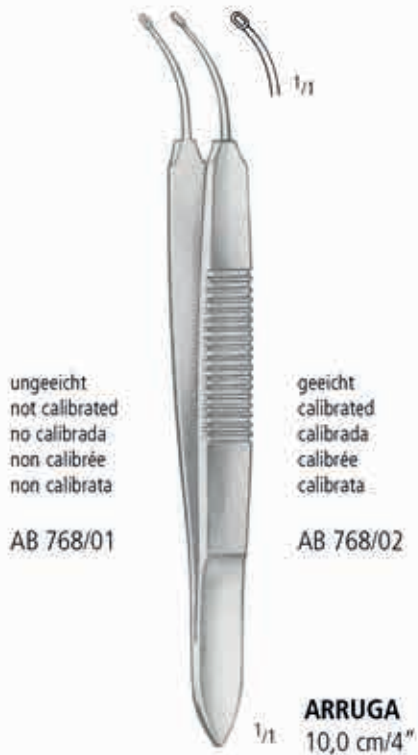

GRAEFE
 11,0 cm/4 1/2"



AB 786/01
 5 mm



AB 786/02
 10 mm

GREEN
 10,0 cm/4"

AA
 AB
 AC
 AD
 AE
 AK
 AR
 KA
 KM
 KO
 KP
 XR

AB PINZETTEN FORCEPS PINZAS PINCES PINZE

Fixierpinzetten, Nahtpinzetten
 Fixation Forceps, Suture Forceps
 Pinzas de fijación, Pinzas para sutura
 Pincès à fixer, Pincès pour sutures
 Pinze fissatrici, Pinze per sutura



AB 790/09



AB 791/09

CASTROVIEJO 1:1
 9,0 cm/3 1/2"



ELSCHNIG 1:2
 AB 792/11
 11,0 cm/4 1/2"

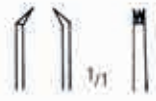

ELSCHNIG 2:3
 AB 793/11
 11,0 cm/4 1/2"

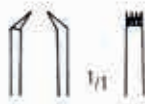

ELSCHNIG 3:4
 AB 794/11
 11,0 cm/4 1/2"



1:2
 AB 796/02



2:3
 AB 796/03

LESTER
 9,0 cm/3 1/2"



MOORFIELD
 AB 798/10
 10,0 cm/4"

PINZETTEN FORCEPS PINZAS PINCES PINZE

Nahtpinzetten
Suture Forceps
Pinzas para sutura
Pincas pour sutures
Pinze per sutura

AA

AB

AC

AD

AE

AK

AR

KA

KM

KO

XP

XR



BARRAQUER
5,5 cm/2¹/₄"



ST. MARTIN 1:2
AB 812/07
7,0 cm/2³/₄"

Vorderkammer-Pinzetten
Anterior Chamber Forceps
Pinzas para la cámara anterior
Pincas pour la chambre antérieure
Pinze per la camera anteriore



0,12 mm
0,30 mm
0,50 mm
1,00 mm
1,50 mm

AB 816/01
AB 816/03
AB 816/05
AB 816/10
AB 816/15

CASTROVIEJO 1:2
10,0 cm/4"



AB 817/01
AB 817/03
AB 817/05
AB 817/10
AB 817/15

CASTROVIEJO 1:2
10,0 cm/4"



McPHERSON
10,0 cm/4"

AB PINZETTEN FORCEPS PINZAS PINCES PINZE

Nahtpinzetten
Suture Forceps
Pinzas para sutura
Pinces pour sutures
Pinze per sutura



KELMAN-McPHERSON 1:2
AB 820/10
10,0 cm/4"



BONACCOLTO
AB 824/01
10,0 cm/4"



BONACCOLTO
AB 824/02
10,0 cm/4"



MOD. BONN
10,0 cm/4"



MOD. TUBINGEN
AB 826/10
10,0 cm/4"

PINZETTEN FORCEPS PINZAS PINCES PINZE

Nahtpinzetten, Fadenpinzetten
 Suture Forceps, Suture Tying Forceps
 Pinzas para sutura, Pinzas de ligadura
 Pincas pour sutures, Pincas à ligature
 Pinze per sutura, Pinze per ligature



PAUFIQUE 1:2
 AB 828/10
 10,0 cm/4"



HARMS
 AB 829/01
 10,0 cm/4"



HARMS
 AB 829/02
 10,0 cm/4"

AA

AB

AC

AD

AE

AK

AR

KA

KM

KO

XP

XR

AB PINZETTEN FORCEPS PINZAS PINCES PINZE

Muskelpinzetten
Muscular Forceps
Pinzas musculares
Pincas musculaires
Pinze muscolari



PINZETTEN FORCEPS PINZAS PINCES PINZE

Muskelpinzetten, Entropium- und Chalazionpinzetten
 Muscular Forceps, Entropium and Chalazion Forceps
 Pinzas musculares, Pinzas de entropión y de chalazión
 Pincas musculaires, Pincas à entropion et à chalazion
 Pinze muscolari, Pinze per palpebre (entropio) e per calazio



BERENS
 AB 835/09
 8,5 cm/3 1/2"



ERHARDT
 AB 836/09
 9,0 cm/3 1/2"



SNELLEN
 AB 837/01
 10,0 cm/4"



SNELLEN
 AB 837/02
 10,0 cm/4"



AYER
 AB 838/01
 9,0 cm/3 1/2"



AYER
 AB 838/02
 9,0 cm/3 1/2"



DESMARRES
 9,0 cm/3 1/2"



AB 840/01

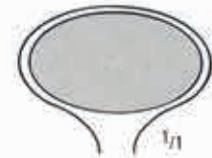

AB 840/02

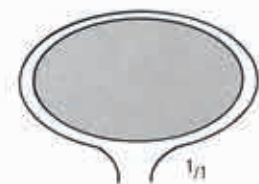

AB 840/03

AA
AB
 AC
 AD
 AE
 AK
 AR
 KA
 KM
 KO
 KP
 XR

AB PINZETTEN FORCEPS PINZAS PINCES PINZE

Chalazionpinzetten, Ptosispinzetten
 Chalazion Forceps, Ptosis Forceps
 Pinzas de chalazión, Pinzas para ptosis
 Pincès à chalazion, Pincès à ptosis
 Pinze per calazio, Pinze per ptosis



LAMBERT
 AB 841/01
 9,0 cm/3 1/2"

1/1



LAMBERT
 AB 841/02
 9,0 cm/3 1/2"

1/1



BERKE
 AB 844/20
 11,0 cm/4 1/2"
 20 mm

1/1



BERKE
 AB 844/27
 11,0 cm/4 1/2"
 27 mm

1/1

PINZETTEN FORCEPS PINZAS PINCES PINZE

Linsenhalte- und Kapsulorhexispinzetten
 Lens Holding and Capsulorhexis Forceps
 Pinzas para tener cristalino y capsulorhexis
 Pincas à tenir de cristallins et capsulorhexis
 Pinze per tenere il cristallino, Pinze capsulorhexis

AA

AB

AC

AD

AE

AK

AR

KA

KM

KD

XP

XR



FAULKNER
 AB 848/11
 11,0 cm/4 1/2"



McDONALD
 AB 852/01
 10,0 cm/4"



McDONALD
 AB 852/02
 10,0 cm/4"

SCHEREN
SCISSORS
TIJERAS
CISEAUX
FORBICI

AC

nopa[®] instruments

Weitere Scheren finden Sie in unserem Katalog „Allgemeines Instrumentarium“ in Gruppe AC.

For further scissors kindly refer to our catalogue „General Instruments“, section AC.

Para tijeras adicionales, por favor consulte nuestro catálogo de „Instrumental de uso general“, grupo AC.

Pour des ciseaux supplémentaires, consultez notre catalogue „Instrumentation Generale“, section AC.

Per gli altri forbici, consultare il nostro catalogo „Strumentazione Generale“, gruppo AC.



SCHEREN SCISSORS TIJERAS CISEAUX FORBICI

Feine Scheren, Augenscheren
 Fine Scissors, Eye Scissors
 Tijeras finas, Tijeras oculares
 Ciseaux fins, Ciseaux oculaires
 Forbici fini, Forbici oftalmologici

AA
 AB
 AC
 AD
 AE
 AK
 AR
 KA
 KM
 KO
 KP
 XR

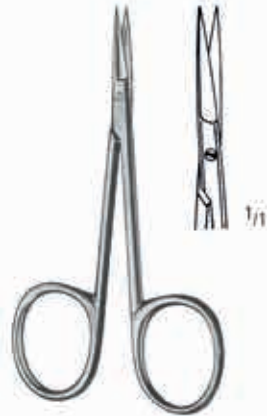

AC 430/08
 8,0 cm/3 1/4"



AC 431/08
 8,0 cm/3 1/4"

MOD. BONN



11,5 cm/4 1/2"

Fig. 1

gerade
 straight
 rectas
 droits
 rette

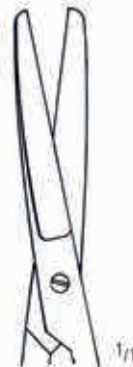

AC 446/01

Fig. 2



AC 446/02

Fig. 1

gebogen
 curved
 curvas
 courbes
 curve



AC 447/01

Fig. 2



AC 447/02

Augenscheren
 Eye Scissors
 Tijeras oculares
 Ciseaux oculaires
 Forbici oftalmologici



AC 448/11
 11,5 cm/4 1/2"



AC 449/11
 11,5 cm/4 1/2"

Irisscheren
 Iris Scissors
 Tijeras para iridectomia
 Ciseaux à iridectomie
 Forbici per iridectomia



Original 10,5 cm

9,0 cm/3 1/2"
 10,5 cm/4 1/4"
 11,5 cm/4 1/2"

AC 450/09
 AC 450/10
 AC 450/11

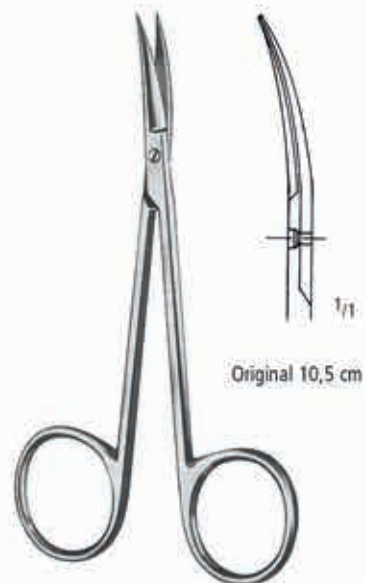

Original 10,5 cm

AC 451/09
 AC 451/10
 AC 451/11

SCHEREN SCISSORS TIJERAS CISEAUX FORBICI

Augenscheren
Eye Scissors
Tijeras oculares
Ciseaux oculaires
Forbici oftalmologici

AA
AB
AC
AD
AE
AK
AR
KA
KM
KO
KP
XR



AC 460/11
11,5 cm/4 1/2"

Strabimusscheren
Strabismus Scissors
Tijeras para estrabismo
Ciseaux à strabisme
Forbici per strabismo



AC 461/11
11,5 cm/4 1/2"

mit großen Ringen
with large bows
con anillos grandes
avec grands anneaux
con anelli grandi

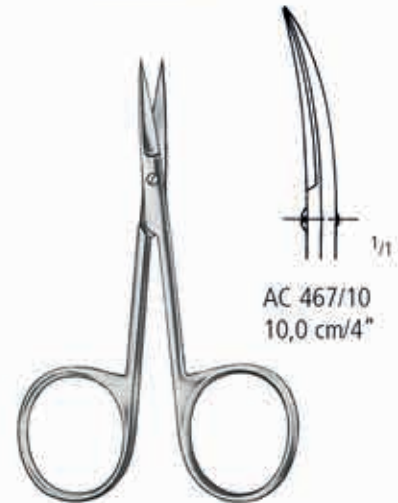

AC 467/10
10,0 cm/4"



GRAEFE
AC 469/10
10,5 cm/4 1/4"

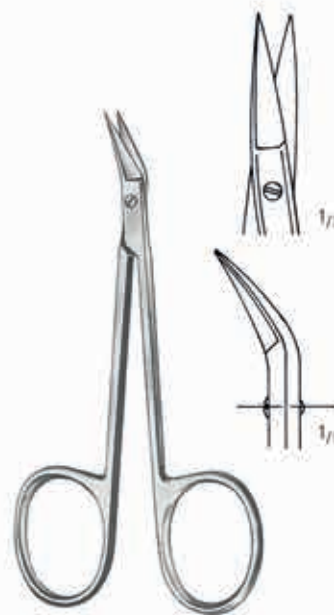

WILMER
AC 471/10
10,0 cm/4"

Augenscheren
Eye Scissors
Tijeras oculares
Ciseaux oculaires
Forbici oftalmologici



LA GRANGE
AC 472/11
11,5 cm/4¹/₂"



CHADWICK
AC 473/11
11,0 cm/4¹/₄"

Sehnenscheren
Tenotomy Scissors
Tijeras para tenotomia
Ciseaux à ténatomie
Forbici per tenotomia



STEVENS
10,5 cm/4¹/₈"
11,5 cm/4¹/₂"

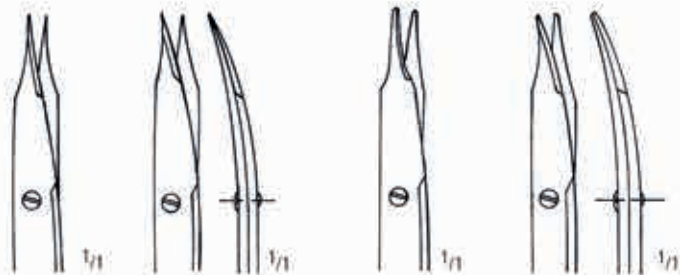

spitz
agudas
pointed
pointues
acuta

Original 11,5 cm

stumpf
romas
blunt
mousses
smussa

gerade
straight
rectas
droits
rette

gebogen
curved
curvas
courbes
curve

gerade
straight
rectas
droits
rette

gebogen
curved
curvas
courbes
curve

AC 474/10
AC 474/11

AC 475/10
AC 475/11

AC 476/10
AC 476/11

AC 477/10
AC 477/11

SCHEREN SCISSORS TIJERAS CISEAUX FORBICI

Augenscheren
Eye Scissors
Tijeras oculares
Ciseaux oculaires
Forbici oftalmologici

AA

AB

AC

AD

AE

AK

AR

KA

KM

KO

KP

XR

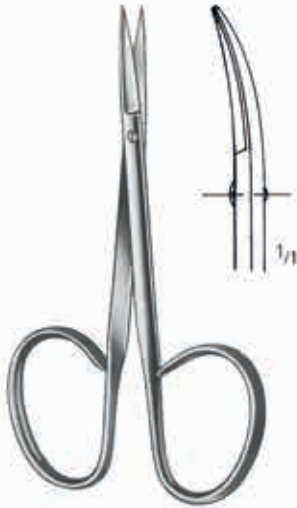

gerade
straight
rectas
droits
rette

gebogen
curved
curvas
courbes
curve

RIBBON

10,0 cm/4"

AC 488/10

AC 489/10



gerade
straight
rectas
droits
rette

gebogen
curved
curvas
courbes
curve

RIBBON

10,0 cm/4"

AC 490/10

AC 491/10

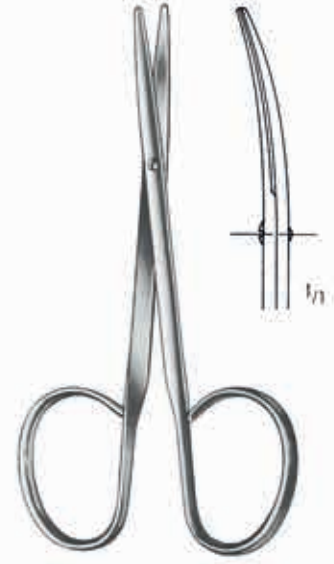

gerade
straight
rectas
droits
rette

gebogen
curved
curvas
courbes
curve

RIBBON

10,0 cm/4"

AC 492/10

AC 493/10

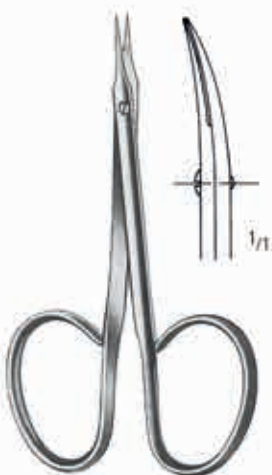

gerade
straight
rectas
droits
rette

gebogen
curved
curvas
courbes
curve

RIBBON

9,5 cm/3³/₄"

AC 494/09

AC 495/09

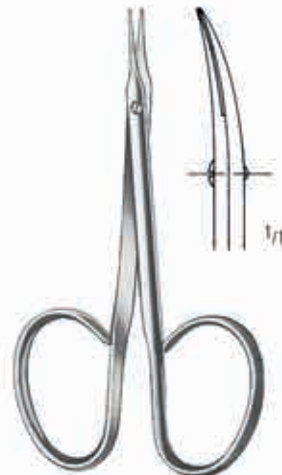

gerade
straight
rectas
droits
rette

gebogen
curved
curvas
courbes
curve

RIBBON

9,5 cm/3³/₄"

AC 496/09

AC 497/09

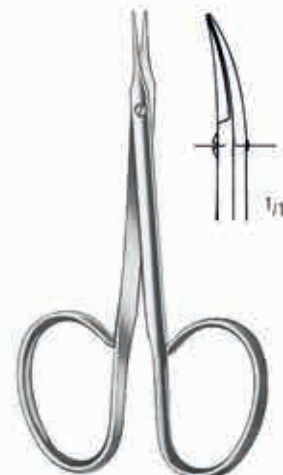

gerade
straight
rectas
droits
rette

gebogen
curved
curvas
courbes
curve

RIBBON

9,5 cm/3³/₄"

AC 498/09

AC 499/09

AC SCHEREN SCISSORS TIJERAS CISEAUX FORBICI

Ligaturscheren, Iridektomiescheren
 Ligature Scissors, Iris Scissors
 Tijeras para ligaduras, Pinzas-tijeras para iridectomía
 Ciseaux à ligatures, Ciseaux à iridectomie
 Forbici per legatura, Forbici per iridectomia



SPENCER
 9,5 cm/3¹/₂" AC 500/09
 10,5 cm/4¹/₄" AC 500/10



NOYES
 12,0 cm/4³/₄"

Fig.1 AC 750/12
 Fig.2 AC 752/12
 Fig.3 AC 754/12



AC 751/12
 AC 753/12
 AC 755/12



WECKER
 11,0 cm/4¹/₂"

AC 760/11

AC 762/11

AC 764/11

SCHEREN SCISSORS TIJERAS CISEAUX FORBICI

Iridektomiescheren
 Iris Scissors
 Pinzas-tijeras para iridectomia
 Ciseaux à iridectomie
 Forbici per iridectomia



BARRAQUER
 5,5 cm/2 1/4"

- 5 mm AC 768/05
- 7 mm AC 768/07
- 10 mm AC 768/10



CASTROVIEJO
 AC 770/00
 9,0 cm/3 1/2"



AC 770/02



AC 770/03



AC 771/09



AC 772/09



AC 773/10

spitz
 pointed
 agudas
 pointues
 acuta

CASTROVIEJO
 10,0 cm/4"

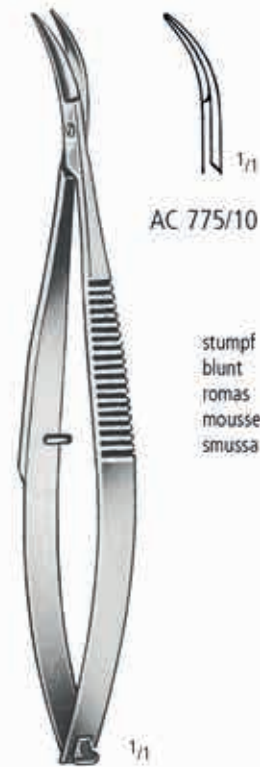

AC 775/10

stumpf
 blunt
 romas
 mousses
 smussa

CASTROVIEJO
 10,0 cm/4"

AA
 AB
 AC
 AD
 AE
 AK
 AR
 KA
 KM
 KO
 KP
 XR

AC SCHEREN SCISSORS TIJERAS CISEAUX FORBICI

Nachstarscheren
 Secondary Cataract Scissors
 Pinzas-tijeras para catarata secundaria
 Pincis ciseaux pour le cataracte secondaire
 Pinze-forbici per cataratta secundaria



gerade
 straight
 rectas
 droiti
 rette

AC 776/01
 8,5 cm/3 1/2"



gebogen
 curved
 curvas
 courbes
 curve

AC 776/02
 8,5 cm/3 1/2"



kniegebogen
 angular
 acodadas
 coudés
 angolato

AC 776/03
 8,5 cm/3 1/2"



aufgewinkelt
 angled on flat
 acodadas hacia arriba
 coudés vers le haut
 angolato in alto

AC 776/04
 8,5 cm/3 1/2"

VANNAS MOD. TÜBINGEN



gerade
 straight
 rectas
 droiti
 rette

VANNAS
 AC 778/01
 8,0 cm/3 1/4"



gebogen
 curved
 curvas
 courbes
 curve

VANNAS
 AC 778/02
 8,0 cm/3 1/4"



kniegebogen
 angular
 acodadas
 coudés
 angolato

VANNAS
 AC 778/03
 8,0 cm/3 1/4"



aufgewinkelt
 angled on flat
 acodadas hacia arriba
 coudés vers le haut
 angolato in alto

VANNAS
 AC 778/04
 8,0 cm/3 1/4"

SCHEREN SCISSORS TIJERAS CISEAUX FORBICI

Nachstarscheren, Sehnenscheren, Hornhautscheren
 Secondary Cataract Scissors, Tenotomy Scissors, Corneal Scissors
 Pinzas-tijeras para catarata secundaria, Pinzas-tijeras para tenotomía y córnea
 Pincès ciseaux pour le cataracte secondaire, Ciseaux à ténatomie, Ciseaux corneales
 Pinze-forbici per cataratta secondaria, Forbici per tenotomia e per cornea



GILLS-WELSH
 8,5 cm/3 1/2"



AC 779/01



AC 779/02



AC 779/03

kniegebogen
 angular
 acodadas
 coudés
 angolato



AC 779/04

aufgewinkelt
 angled on flat
 acodadas hacia arriba
 coudés vers le haut
 angolato in alto



WESTCOTT
 AC 780/11
 11,0 cm/4 1/2"



WESTCOTT
 AC 782/11
 11,0 cm/4 1/2"



CASTROVIEJO
 AC 785/01
 10,0 cm/4"



CASTROVIEJO
 AC 785/02
 10,0 cm/4"

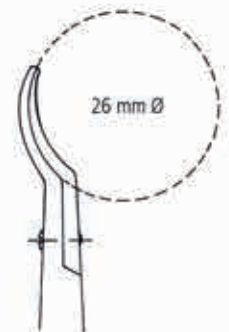

26 mm Ø

AA
 AB
 AC
 AD
 AE
 AK
 AR
 KA
 KM
 KO
 KP
 XR

AC SCHEREN SCISSORS TIJERAS CISEAUX FORBICI

Hornhautscheren
 Corneal Scissors
 Pinzas-tijeras para córnea
 Ciseaux corneales
 Forbici per cornea



CASTROVIEJO
 AC 786/01
 11,0 cm/4 1/2"



CASTROVIEJO
 AC 786/02
 11,0 cm/4 1/2"



TROUTMAN
 AC 788/01
 10,0 cm/4"



TROUTMAN
 AC 788/02
 10,0 cm/4"



KATZIN
 AC 790/01
 10,0 cm/4"



KATZIN
 AC 790/02
 10,0 cm/4"



KATZIN
 AC 791/01
 11,0 cm/4 1/2"



KATZIN
 AC 791/02
 11,0 cm/4 1/2"

SCHEREN SCISSORS TIJERAS CISEAUX FORBICI

Hornhautscheren
 Corneal Scissors
 Pinzas-tijeras para córnea
 Ciseaux corneales
 Forbici per cornea

AA

AB

AC

AD

AE

AK

AR

KA

KM

KO

KP

XR



KATZIN-BARRAQUER

AC 792/01
 10,0 cm/4"



AC 792/02
 10,0 cm/4"



AC 793/00
 10,0 cm/4"



AC 793/01
 10,0 cm/4"

Hornhautscheren, Mikroscheren
 Corneal Section Scissors, Micro Scissors
 Pinzas-tijeras para córnea, Micro Tijeras
 Pincès ciseaux corneales, Micro-ciseaux
 Forbici per cornea, Micro forbici



AC 794/12
 12,0 cm/4³/₄"



NOYES
 AC 795/15
 15,0 cm/6"



WESTCOTT
 AC 797/01
 11,5 cm/4¹/₂"



WESTCOTT
 AC 797/02
 11,5 cm/4¹/₂"

SCHEREN SCISSORS TIJERAS CISEAUX FORBICI

Mikroschere
Micro Scissors
Micro Tijeras
Micro Ciseaux
Micro Forbici

- >> Alle unsere Mikroschere werden von Fachkräften mit jahrelanger Erfahrung hergestellt. Die Endkontrolle findet unter dem Mikroskop statt. Um Ihnen ein ermüdungsfreies Arbeiten zu ermöglichen, wird dem Federdruck größte Aufmerksamkeit gewidmet.
- >> Bitte wählen Sie unter Rund- oder Flachgriffschere.



Dissection: **Gebogene Blätter, abgerundete Spitzen** ermöglichen eine gute und sichere Dissektion, ohne Nerven und Blutgefäße zu beschädigen.



Adventitia: **Gerade Blätter, sehr scharfe Spitzen** gewährleisten präzises Anfrischen von Gefäßenden.

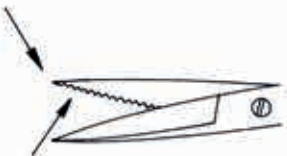

Nerve: Ein Blatt ist **fein gezahnt**, um ein Herausgleiten des Nervs zu vermeiden.

- >> All our Micro Scissors are manufactured by skilled craftsmen with many years of experience. Final inspection is carried out under a microscope. Careful attention is paid to the closing pressure of the spring handle, to ensure precise work during surgeries, without fatigue.
- >> Round or flat handle scissors according to your preference.



Dissection: **Curved blades, slightly rounded tips** ensure safe dissection without damage to nerves and vessels.

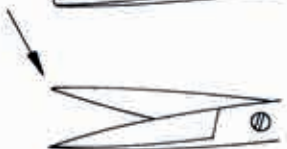

Adventitia: **Straight blades, very sharp tips** for finest trimming of vessel ends.

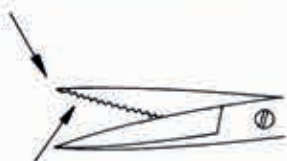

Nerve: One blade is **fine-toothed** to avoid slipping of the nerve.

AA

AB

AC

AD

AE

AK

AR

KA

KM

KD

XP

XR

Mikroscheren
Micro Scissors
Micro Tijeras
Micro Ciseaux
Micro Forbici



14,5 cm/5³/₄"



Dissection
AC 801/15



Adventitia
AC 803/15



18,0 cm/7"



Dissection
AC 801/18

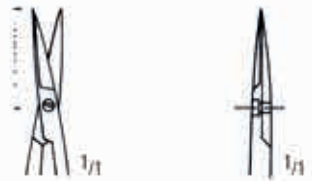

Adventitia
AC 803/18

SCHEREN SCISSORS TIJERAS CISEAUX FORBICI

Mikroscheren
Micro Scissors
Micro Tijeras
Micro Ciseaux
Micro Forbici

AA

AB

AC

AD

AE

AK

AR

KA

KM

KD

XP

XR

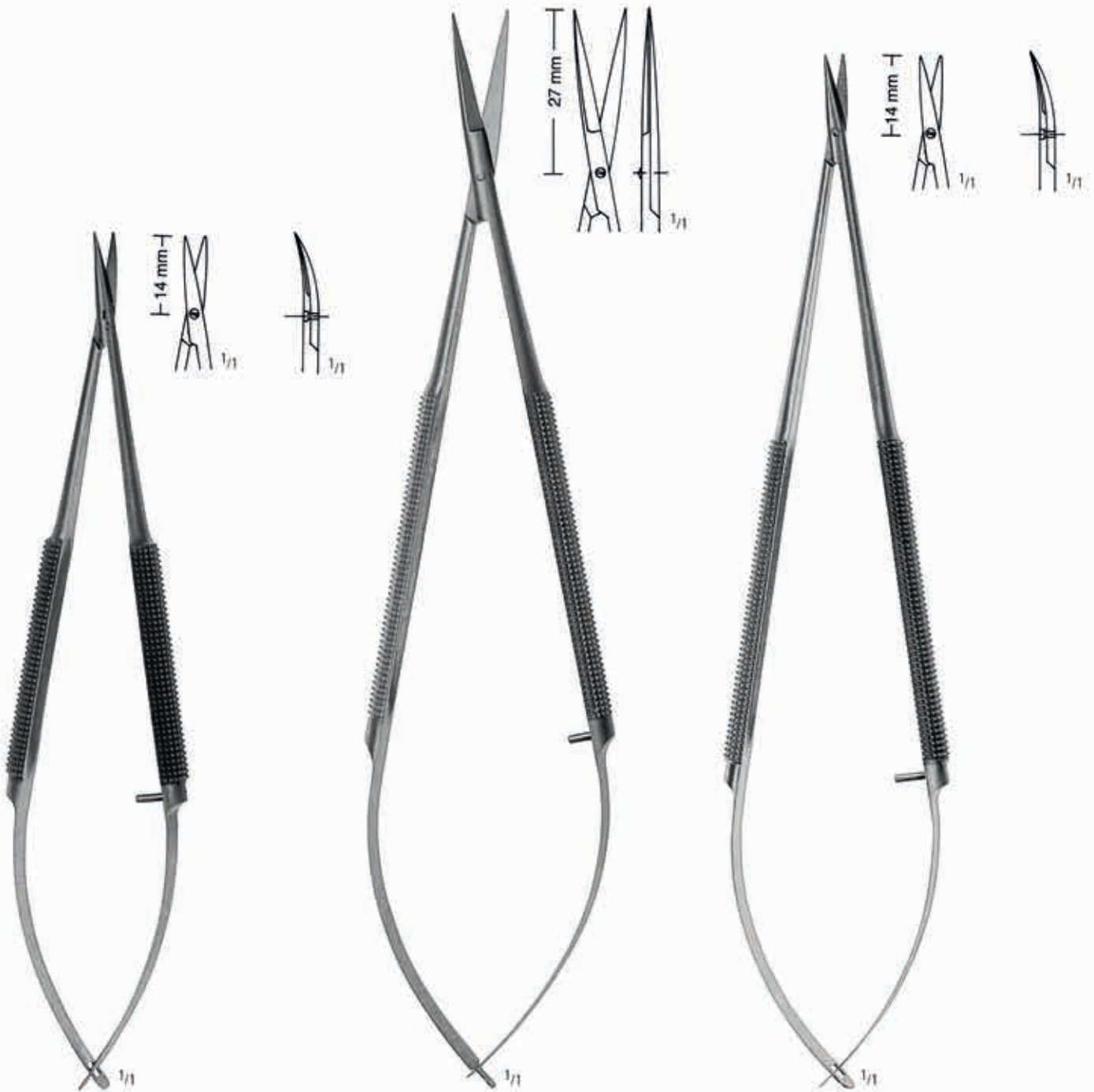

AC 807/14
14,5 cm/5³/₄"

AC 812/18
18,0 cm/7"

AC 817/18
18,0 cm/7"

Mikroscheren
Micro Scissors
Micro Tijeras
Micro Ciseaux
Micro Forbici



11,0 cm/4 1/3"

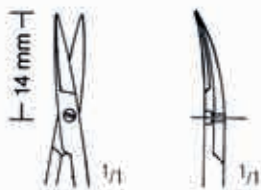

Dissection
AC 821/11

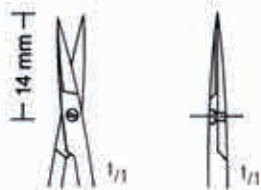

Adventitia
AC 830/11



15,0 cm/6"

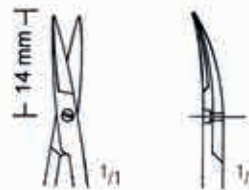

Dissection
AC 823/15

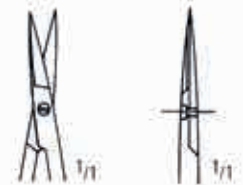

Adventitia
AC 832/15

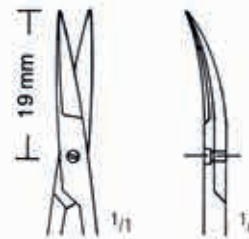

Dissection
AC 825/15

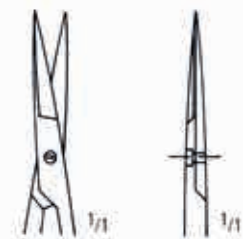

Adventitia
AC 834/15

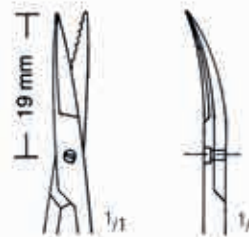

Dissection
AC 827/15

>> Nerve >>

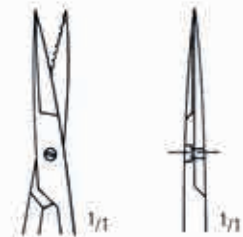

Adventitia
AC 836/15

SCHEREN SCISSORS TIJERAS CISEAUX FORBICI

Mikroscheren
Micro Scissors
Micro Tijeras
Micro Ciseaux
Micro Forbici

AA

AB

AC

AD

AE

AK

AR

KA

KM

KD

XP

XR



18,5 cm/7 1/3"



20 mm

AC 850/19



AC 851/19



16,0 cm/6 1/4"
20,0 cm/8"
22,5 cm/9"



AC 860/16
AC 860/20
AC 860/22



AC 861/16
AC 861/20
AC 861/22



AC 862/16
AC 862/20
AC 862/22



AC 863/16
AC 863/20
AC 863/22



AC 864/16
AC 864/20
AC 864/22



AC 865/16
AC 865/20
AC 865/22

Mikroscheren
Micro Scissors
Micro Tijeras
Micro Ciseaux
Micro Forbici

T = TITAN



18,0 cm/7"



AC 870/01
AC 870/01 T
25°



AC 870/02
AC 870/02 T
45°



AC 870/03
AC 870/03 T
60°



AC 870/04
AC 870/04 T
90°



AC 870/05
AC 870/05 T
125°



18,0 cm/7"



18,0 cm/7"



AC 871/01
AC 871/01 T
25°



AC 871/02
AC 871/02 T
45°



AC 871/03
AC 871/0
60°



AC 871/04
AC 871/04 T
90°



AC 871/05
AC 871/05 T
125°



18,0 cm/7"

SKALPELLE
SCALPELS
BISTURIES
BISTOURIS
BISTURI

AD

nopa[®] instruments

Weitere Skalpelle finden Sie in unserem Katalog „Allgemeines Instrumentarium“ in Gruppe AD.

For further scalpels kindly refer to our catalogue „General Instruments“, section AD.

Para bisturías adicionales, por favor consulte nuestro catálogo de „Instrumental de uso general“, grupo AD.

Pour des bistouris supplémentaires, consultez notre catalogue „Instrumentation Generale“, section AD.

Per gli altri bisturi, consultare il nostro catalogo „Strumentazione Generale“, gruppo AD.





SKALPELLE SCALPELS BISTURIES BISTOURIS BISTURI

Skalpelligriffe
 Scalpel Handles
 Mangos de bisturios
 Manches pour bistouris
 Manici per bisturi

AA

AB

AC

AD

AE

AK

AR

KA

KM

KD

KP

XR



hohl
 hollow
 hueco
 creux
 vuoto

AD 009/03
 No. 3

AD 010/03
 No. 3

AD 020/13
 No. 3L

AD 025/07
 No. 7

AD 027/07
 No. 7K

AD 030/16

COLLIN
 AD 040/08
 No. 8

Skalpellgriffe, Skalpellklingen
 Scalpel Handles, Scalpel Blades
 Mangos de bisturios, Hojas de bisturios
 Manches pour bistouris, Lames de bistouris
 Manici per bisturi, Lame per bisturi

MINI

Verpackungseinheit 10 St.
 packing unit 10 pcs.
 unidad de venta 10 piezas
 unité à 10 pièce
 unità di vendita 10 pezzi



Fig. 65
 AD 065/65

steril
 sterile
 estériles
 stériles
 sterili



Fig. 67
 AD 065/67



AD 065/10



AD 065/13



AD 065/15

SKALPELLE SCALPELS BISTURIES BISTOURIS BISTURI

Skalpellklingen
Scalpel Blades
Hojas de bisturios
Lames pour bistouris
Lame per bisturi

passend für die Griffe
for handles
para los mangos
pour les manches
per i manici

- AD 009/03
- AD 010/03
- AD 020/13
- AD 025/07
- AD 027/07
- AD 030/16
- AD 040/08



Fig.10
AD 075/10



Fig.11
AD 075/11



Fig.15
AD 075/15



Fig.15c
AD 076/15

steril
sterile
estériles
stériles
sterili



AA

AB

AC

AD

AE

AK

AR

KA

KM

KO

XP

XR

Rasierklingen, Klingenbrecher
 Razor Blades, Blade Breakers
 Hojas de afeitár, Pinzas para romper hojas
 Lames de rasoir, Pincettes pour casser les lames
 Lamette da barba, Pinze per rompere la lamette

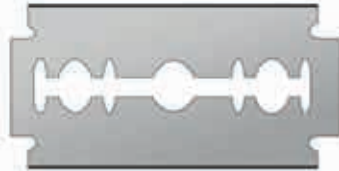

RASIERKLINGEN, VERPACKUNGSEINHEIT 10 STÜCK
 RAZOR BLADES, PACKING UNIT 10 PIECES
 HOJAS DE AFEITAR, UNIDAD DE VENTA 10 PZ
 LAMES DE RASOIR, UNITÉ À 10 PIÈCES
 LAMETTE DA BARBA, UNITÀ DI VENDITA 10 PZ

AD 540/00



TROUTMAN-CHRIS
 AD 550/09
 Ø 5,5 mm
 9,0 cm/3 1/2"



TROUTMAN-CHRIS
 AD 551/09
 Ø 5,5 mm
 9,0 cm/3 1/2"



AD 552/11
 11,0 cm/4 1/3"



CASTROVIEJO
 AD 554/13
 Ø 8 mm
 13,0 cm/5"

NAHT
SUTURE
SUTURA
SUTURE
SUTURA

AE

nopa[®] instruments

Weitere Naht-Instrumente finden Sie in unserem Katalog „Allgemeines Instrumentarium“ in Gruppe AE.

For further suture instruments kindly refer to our catalogue „General Instruments“, section AE.

Para instrumentos de sutura adicionales, por favor consulte nuestro catálogo de „Instrumental de uso general“, grupo AE.

Pour des instruments de suture supplémentaires, consultez notre catalogue „Instrumentation Generale“, section AE.

Per gli altri accessori di sutura, consultare il nostro catalogo „Strumentazione Generale“, gruppo AE.



Nadelhalter, Nadelhalter mit Hartmetalleinsätzen
 Needle Holders, Needle Holders with Tungsten Carbide Inserts
 Porta-agujas, Porta-agujas con bocas de carburo de Tungsteno
 Porte-aiguilles, Porte-aiguilles à mors en carbure de tungstène
 Portaghi, Portaghi con placche di carburo di tungsteno



DERF
 AE 050/12
 12,5 cm/4³/₄"



HALSEY
 13,0 cm/5"

nopa[®]
TUC



RYDER/FRENCH-EYE
 AE 430/13
 13,0 cm/5"



DERF
 AE 450/12
 12,5 cm/4³/₄"

T = TITAN



AE 464/13



AE 466/13
 AE 466/13 T

HALSEY
 13,0 cm/5"

NAHT SUTURE SUTURA SUTURE SUTURA

Nadelhalter mit Hartmetalleinsätzen
 Needle Holders with Tungsten Carbide Inserts
 Porta-agujas con bocas de carburo de tungsteno
 Porte-aiguilles à mors en carbure de tungstène
 Portaghi con placche di carburo di tungsteno

T = TITAN



CASTROVIEJO
 14,0 cm/5 1/2"

CASTROVIEJO
 14,0 cm/5 1/2"

nopa®
TUC

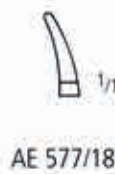
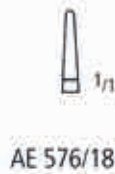

18,0 cm/7"

18,0 cm/7"

AA
 AB
 AC
 AD
AE
 AK
 AR
 KA
 KM
 KO
 KP
 XR

AE NAHT SUTURE SUTURA SUTURE SUTURA

Mikro-Nadelhalter mit Hartmetalleinsätzen
 Micro-Needle Holders with Tungsten Carbide Inserts
 Micro-porta-agujas con bocas de carburo de Tungsteno
 Micro-porte-aiguilles à mors en carbure de tungstène
 Micro-portaghi con placche di carburo di tungsteno



JACOBSON
 21,0 cm/8¹/₄"



AE 580/01



AE 580/02
 AE 580/02 T

T = TITAN



DIETHRICH

nopa®
TUC



AE 582/16
 16,0 cm/6¹/₄"



AE 582/18
 18,0 cm/7"



AE 582/20
 20,0 cm/8"



AE 582/23
 23,0 cm/9"



AE 582/26
 26,0 cm/10¹/₄"



KALT
 AE 584/14
 13,5 cm/5¹/₄"



CASTROVIEJO
 AE 586/13
 13,0 cm/5¹/₄"



POTTS-SMITH
 AE 588/22
 22,0 cm/8³/₄"

NAHT SUTURE SUTURA SUTURE SUTURA

Mikro-Nadelhalter mit Rundgriff
 Micro-Needle-Holders with per-type handle
 Micro-porta-agujas con mango redondo
 Micro-porte-aiguilles à manches rondes
 Micro-portaghi con manici rotondi

AA
 AB
 AC
 AD
 AE
 AK
 AR
 KA
 KM
 KO
 KP
 XR



**BARRAQUER-
TROUTMAN**
 AE 600/10
 10,0 cm/4"



**BARRAQUER-
TROUTMAN**
 AE 601/10
 10,0 cm/4"



**BARRAQUER-
TROUTMAN**
 AE 602/10
 10,0 cm/4"



**BARRAQUER-
TROUTMAN**
 AE 603/10
 10,0 cm/4"



BARRAQUER
 AE 605/11
 11,0 cm/4 1/4"



BARRAQUER
 AE 605/13
 13,0 cm/5"



BARRAQUER
 AE 605/14
 14,0 cm/5 1/2"



BARRAQUER
 AE 606/14
 14,0 cm/5 1/2"



BARRAQUER
 AE 607/14
 14,0 cm/5 1/2"

AE NAHT SUTURE SUTURA SUTURE SUTURA

Mikro-Nadelhalter mit Rundgriff
 Micro-Needle-Holders with pen-type handle
 Micro-porta-agujas con mango redondo
 Micro-porte-aiguilles à manches rondes
 Micro-portaghi con manici rotondi



TROUTMAN
 AE 609/01
 12,0 cm/4³/₄"



TROUTMAN
 AE 609/02
 12,0 cm/4³/₄"



AE 610/15

AE 611/15

REILL
 15,0 cm/6"



AE 612/15

AE 613/15

REILL
 15,0 cm/6"

NAHT SUTURE SUTURA SUTURE SUTURA

Mikro-Nadelhalter
 Micro-Needle-Holders
 Micro-porta-agujas
 Micro-porte-aiguilles
 Micro-portaghi

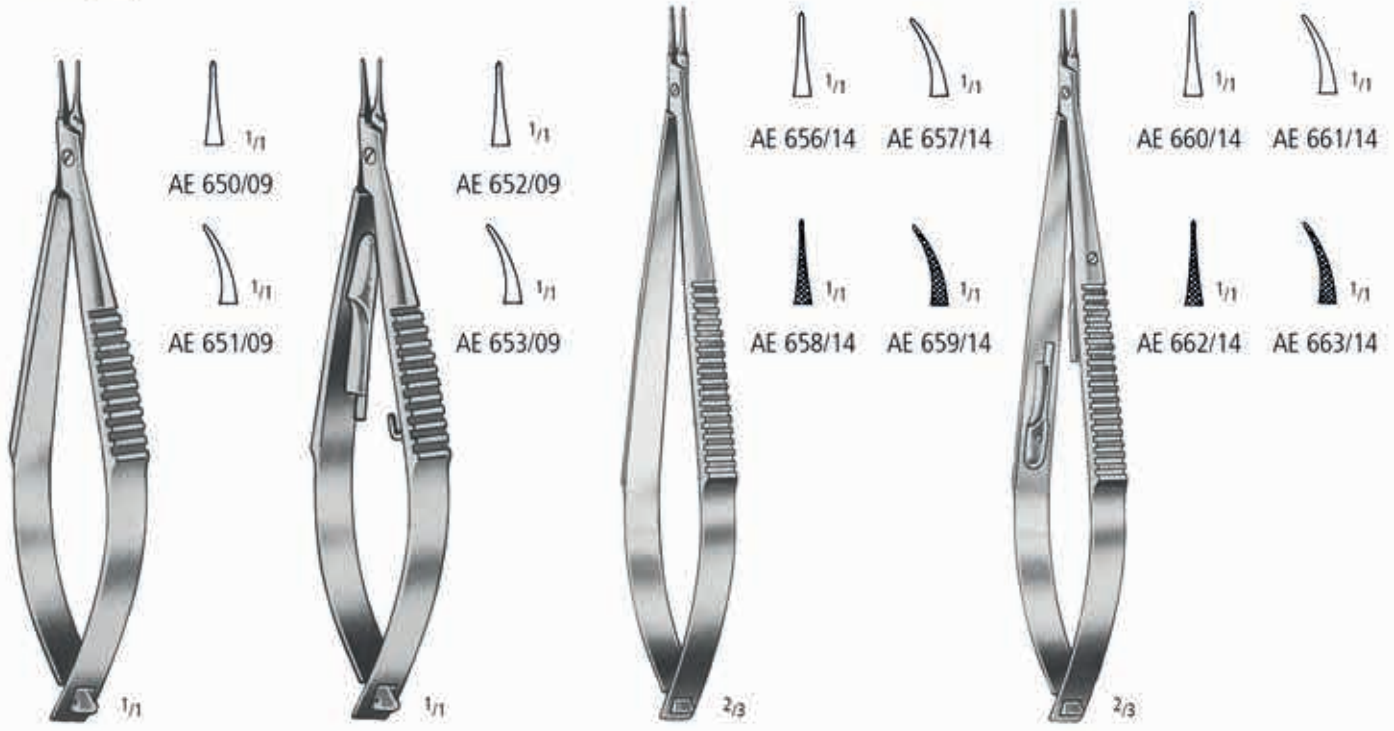

CASTROVIEJO
 9,0 cm/3 1/2"

CASTROVIEJO
 9,0 cm/3 1/2"

CASTROVIEJO
 14,0 cm/5 1/2"

CASTROVIEJO
 14,0 cm/5 1/2"

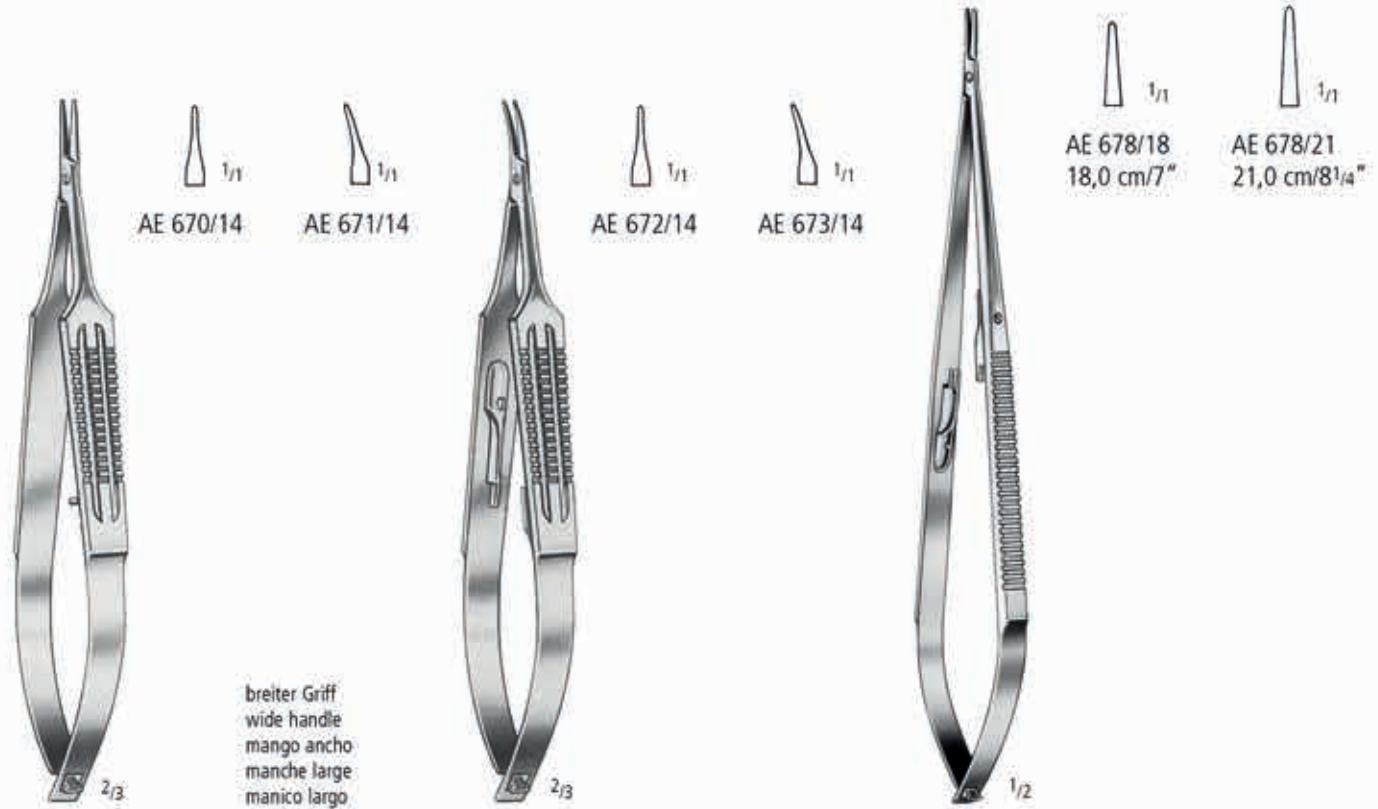

CASTROVIEJO
 14,0 cm/5 1/2"

CASTROVIEJO
 14,0 cm/5 1/2"

JACOBSON
 14,0 cm/5 1/2"

breiter Griff
 wide handle
 mango ancho
 manche large
 manico largo

AA
 AB
 AC
 AD
AE
 AK
 AR
 KA
 KM
 KO
 KP
 XR

AE NAHT SUTURE SUTURA SUTURE SUTURA

Mikro-Nadelhalter
 Micro-Needle-Holders
 Micro-porta-agujas
 Micro-porte-aiguilles
 Micro-portaghi



PATON
 AE 684/11
 11,0 cm/4¹/₂"



PATON
 AE 685/11
 11,0 cm/4¹/₂"



ARRUGA
 14,0 cm/5¹/₂"



KALT
 AE 688/14
 14,0 cm/5¹/₂"



KALT-ARRUGA
 AE 689/14
 14,0 cm/5¹/₂"



CASTROVIEJO-KALT
 AE 690/14
 13,5 cm/5¹/₄"



STEVENS
 AE 692/13 13,0 cm/5"
 AE 692/15 15,0 cm/6"

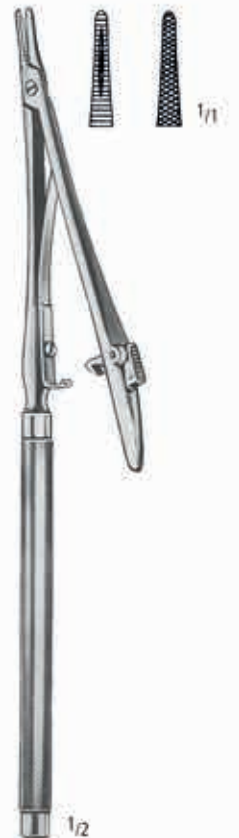

POTTS-SMITH
 AE 694/22
 22,0 cm/8³/₄"

NAHT SUTURE SUTURA SUTURE SUTURA

Mikro-Nadelhalter mit Rundgriff
 Micro-Needle-Holders with per-type handle
 Micro-porta-agujas con mango redondo
 Micro-porte-aiguilles à manches rondes
 Micro-portaghi con manici rotondi

AA
 AB
 AC
 AD
 AE
 AK
 AR
 KA
 KM
 KD
 KP
 XR

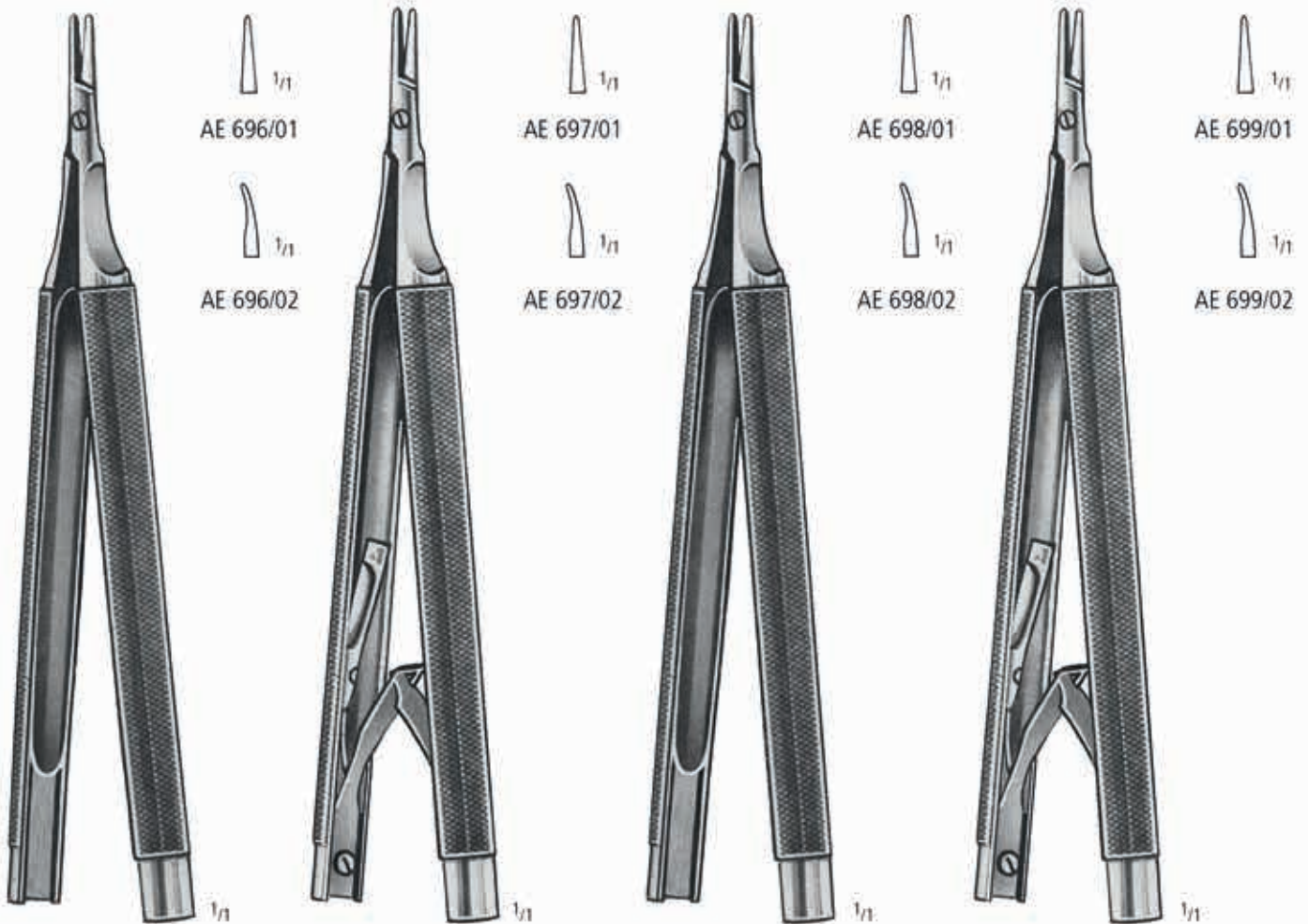

CASTROVIEJO
 13,0 cm/5 1/4"

CASTROVIEJO
 13,0 cm/5 1/4"

CASTROVIEJO
 13,0 cm/5 1/4"

CASTROVIEJO
 13,0 cm/5 1/4"

Ø Griff 8 mm
 Ø Handle 8 mm
 Ø Mango 8 mm
 Ø Manche 8 mm
 Ø Manico 8 mm

Ø Griff 10 mm
 Ø Handle 10 mm
 Ø Mango 10 mm
 Ø Manche 10 mm
 Ø Manico 10 mm

DIAGNOSTIK
DIAGNOSTICS
DIAGNOSTICO
DIAGNOSTIC
DIAGNOSTICA

AR

nopa[®] instruments

Weitere Naht-Instrumente finden Sie in unserem Katalog „Allgemeines Instrumentarium“ in Gruppe AE.

For further suture instruments kindly refer to our catalogue „General Instruments“, section AE.

Para instrumentos de sutura adicionales, por favor consulte nuestro catálogo de „Instrumental de uso general“, grupo AE.

Pour des instruments de suture supplémentaires, consultez notre catalogue „Instrumentation Generale“, section AE.

Per gli altri accessori di sutura, consultare il nostro catalogo „Strumentazione Generale“, gruppo AE.



Messinstrumente
 Measuring Instruments
 Instrumentos para medidas
 Instruments pour mesurer
 Strumenti per misurare

AA

AB

AC

AD

AE

AK

AR

KA

KM

KD

XP

XR



1/2

AR 250/15
 15,0 cm/6"



1/1

JAMESON
 AR 261/08
 0 - 80 mm/0-3 inch



1/1

CASTROVIEJO
 AR 282/15
 8,0 cm/3 1/4"

Messbereich 15 mm
 measuring range 15 mm
 campo de medición 15 mm
 étendue de mesurage 15 mm
 ampiezza di misura 15 mm



1/1

CASTROVIEJO
 AR 282/20
 8,0 cm/3 1/4"

Messbereich 20 mm
 measuring range 20 mm
 campo de medición 20 mm
 étendue de mesurage 20 mm
 ampiezza di misura 20 mm



1/1

CASTROVIEJO
 AR 283/20
 8,0 cm/3 1/4"

Messbereich 20 mm
 measuring range 20 mm
 campo de medición 20 mm
 étendue de mesurage 20 mm
 ampiezza di misura 20 mm

Ophthalmoskop
 Ophthalmoscope
 Oftalmoscopio
 Ophthalmoscope
 Oftalmoscopio



OTO- / OPHTHALMOSKOP
 AR 402/00



OPHTHALMOSKOP
 AR 420/00

OPHTHALMOLOGIE
OPHTHALMOLOGY
OFTALMOLOGIA
OPHTALMOLOGIE
OFTALMOLOGIA

KP

nopa[®] instruments



Feine Wundhaken
Delicate Hooks
Ganchos
Crochets très fins
Divaricatori sottili

AA

AB

AC

AD

AE

AK

AR

KA

KM

KO

KP

XR



GILLIES
AK 020/01
18,0 cm/7"



GILLIES
AK 020/02
18,0 cm/7"



KILNER
AK 022/15
15,0 cm/6"



FRAZIER
AK 024/13
13,0 cm/5"



AK 026/01



KLEINERT-KUTZ
AK 026/02
16,0 cm/6¼"



AK 026/03

Feine Wundhaken
 Delicate Hooks
 Ganchos
 Crochets très fins
 Divaricatori sottili

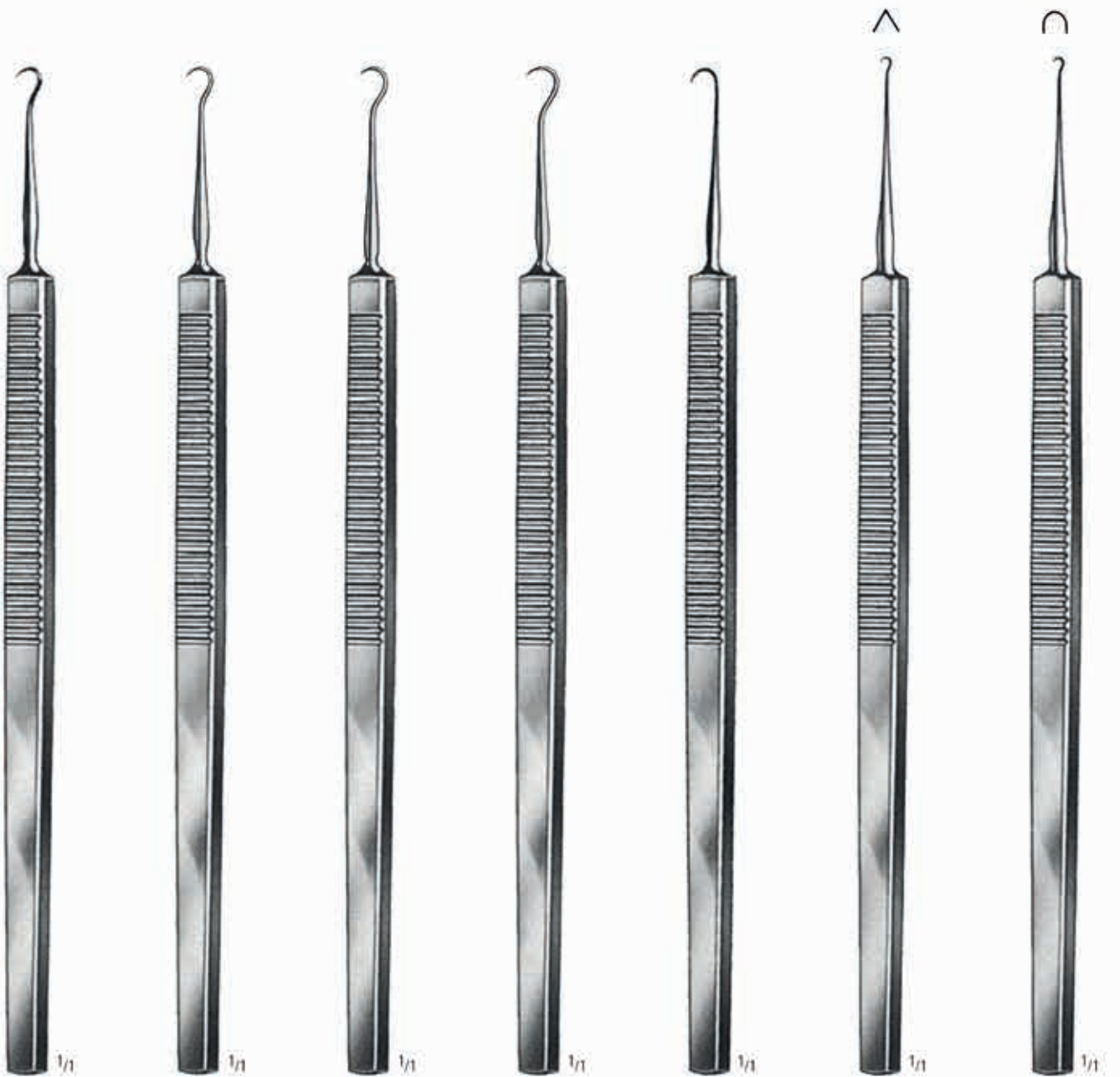

AK 028/01
 16,0 cm/6 1/4"

AK 028/02
 16,0 cm/6 1/4"

AK 028/03
 16,0 cm/6 1/4"

AK 028/04
 16,0 cm/6 1/4"

O' CONNOR
 AK 030/16
 16,0 cm/6 1/4"

GRAEFE
 AK 032/01
 16,0 cm/6 1/4"

GRAEFE
 AK 032/02
 16,0 cm/6 1/4"

Feine Wundhaken
Delicate Hooks
Ganchos
Crochets très fins
Divaricatori sottili

AA

AB

AC

AD

AE

AK

AR

KA

KM

KD

KP

XR



CUSHING
28,0 cm/11"



AK 034/01



AK 034/02



CUSHING
19,0 cm/7 1/2"



AK 036/01



AK 036/02



MOLDESTAD
AK 038/13
13,0 cm/5"



17,0 cm/6 3/4"



AK 040/05
5 mm



AK 040/07
7 mm



18,5 cm/7 1/8"



AK 042/10
Ø 1,0 mm



AK 042/12
Ø 1,2 mm



AK 044/11
11,0 cm/4 1/8"

Feine Wundhaken
Delicate Hooks
Ganchos
Crochets très fins
Divaricatori sottili

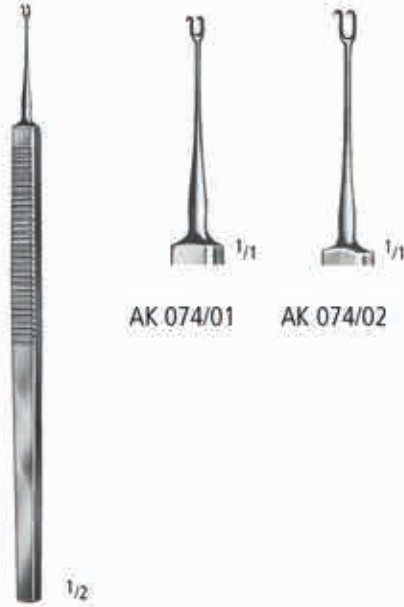

GUTHRIE
16,0 cm/6¹/₄"

ROLLET
AK 076/13
13,0 cm/5"

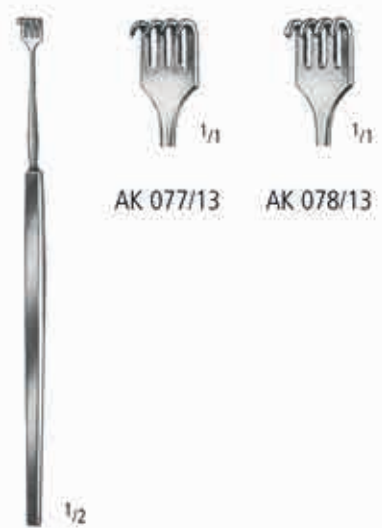

KNAPP
13,0 cm/5"

DESMARRES
13,0 cm/5"

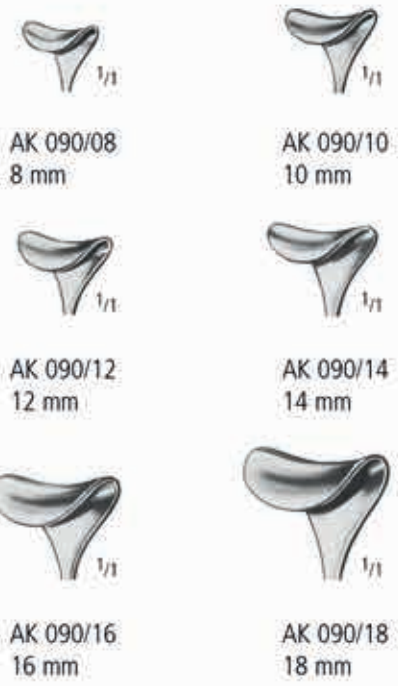

Meißeln, Hammer und Hohlmeißelzangen
 Chisels, Mallet and Bone Rongeurs
 Cinceles, Martillo, Pinzas-gubias
 Ciseaux-burins, Marteau, Pincas-gouges
 Scalpelli, Martello e Pinze-sgorbie



Ø 22 mm
 200 g
 (7 oz.)

PARTSCH
 13,5 cm/5¹/₄"

- KA 433/02
- KA 433/03
- KA 433/04
- KA 433/05
- KA 433/06
- KA 433/07

mm

- 2
- 3
- 4
- 5
- 6
- 7

- KA 443/02
- KA 443/03
- KA 443/04
- KA 443/05
- KA 443/06
- KA 443/07

PARTSCH
 KA 545/20
 18,0 cm/7"

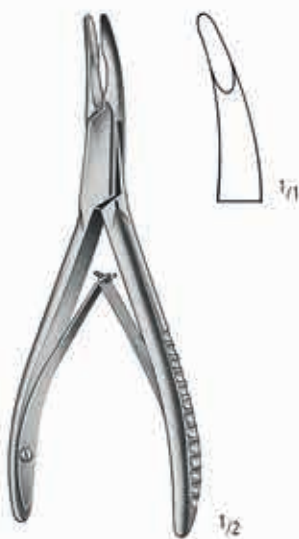

FRIEDMAN
 KA 800/14
 14,0 cm/5¹/₂"



LUER
 17,0 cm/6³/₄"

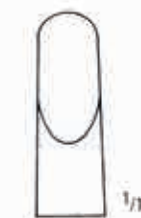

KA 812/17



KA 813/17

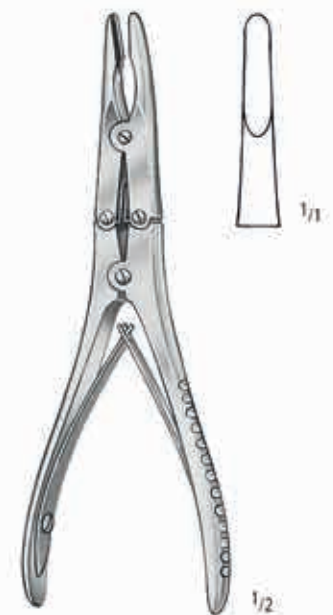

BÖHLER
 KA 825/01
 15,0 cm/6"

AA
 AB
 AC
 AD
 AE
 AK
 AR
 KA
 KM
 KO
 KP
 XR

Stanzen
 Punches
 Pinzas osteótomas
 Pinces ostéotomes
 Pinze osteotomi



CITELLI

 1/2
 KM 490/01
 1 mm

 1/2
 KM 490/02
 2 mm

 1/2
 KM 490/03
 3 mm

NASE RHINOLOGY RINOLOGIA RHINOLOGIE RINOLOGIA

Nasenspekula, Keilbeinstanzen
 Nasal Specula, Sphenoid Punches
 Espéculos nasales, Pinzas para seno esfenoidal
 Spéculum nasaux, Pinces pour sinus sphénoïdal
 Specoli nasali, Pinze per seno sfenoidale

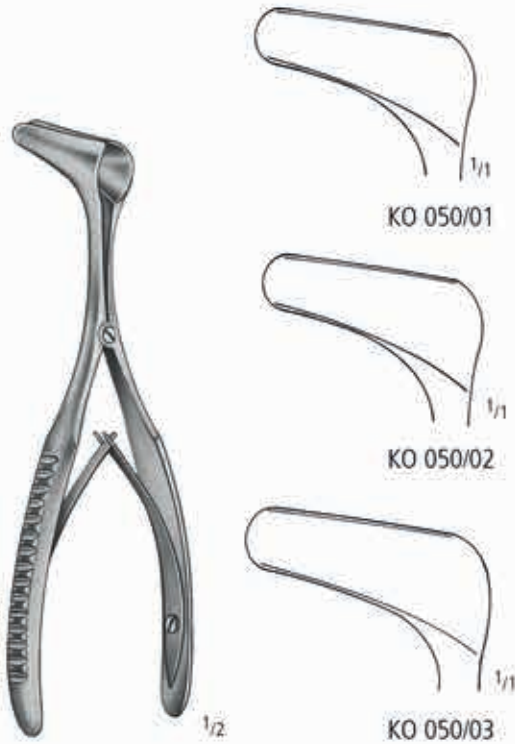

HARTMANN-HALLE
 15,0 cm/6"



KERRISON

Hohlmeißel
 Gouges
 Gubias
 Gouges
 Sgorbie



WEST
 KO 604/04
 16,0 cm/6 1/4"



WEST
 KO 605/04
 16,0 cm/6 1/4"

AA
 AB
 AC
 AD
 AE
 AK
 AR
 KA
 KM
 KO
 KP
 XR

Muskel-, Netzhautablösungs- und Schielhaken
 Muscle, Retinal Detachment and Strabismus Hooks
 Ganchos de músculos, para desprendimiento de retina y para estrabismo
 Crochets musculaires, de décollement de la rétine et à strabisme
 Uncinetti per muscoli e per strabismo



GREEN
 KP 001/13
 13,0 cm/5"

JAMESON
 KP 002/12 12,0 cm/4³/₄"
 KP 002/13 13,0 cm/5"

GASS
 KP 010/14
 14,0 cm/5¹/₂"

GRAEFE
 KP 015/01
 13,0 cm/5"
 Fig. 1

GRAEFE
 KP 015/02
 14,0 cm/5¹/₂"
 Fig. 2

GRAEFE
 KP 015/03
 15,0 cm/6"
 Fig. 3

Sehnenhäkchen, Fixiergabel
 Tenotomy Hook, Fixation Fork
 Gancho de tenotomía, Horquilla fijadora
 Crochet pour tenotomie, Pique de fixation
 Uncinetti de tendini e per fissazione

AA
AB
AC
AD
AE
AK
AR
KA
KM
KO
KP
XR



STEVENS
 KP 018/12
 12,0 cm/4³/₄"



BURCH
 KP 020/13
 13,0 cm/5"



KP 023/01
 11,0 cm/4¹/₂"

rechts
 right
 derecha
 droit
 destra



KP 023/02
 11,0 cm/4¹/₂"

links
 left
 izquierda
 gauche
 sinistra

Irishäkchen
Iris Hooks
Ganchos para iris
Crochets à iris
Uncinetti per l'iride



sehr fein, scharf
very delicate, pointed
delicadísimo, afilado
très fin, coupant
fino, tagliente

BONN
KP 025/14
13,5 cm/5¹/₄"



stumpf
blunt
romo
émoussé
smussato

KNOLLE
KP 026/11
11,0 cm/4¹/₂"



stumpf, abgewinkelt
blunt, angled
romo, angular
émoussé, coudé
smussato, angolato

JAFFE-KNOLLE
KP 027/12
12,0 cm/4³/₄"

Irishäkchen
Iris Hooks
Ganchos para iris
Crochets à iris
Uncinetti per l'iride

AA

AB

AC

AD

AE

AK

AR

KA

KM

KD

KP

XR



1/1

TYRELL
12,0 cm/4³/₄"



KP 029/01

stumpf
blunt
romo
émoussé
smussato



KP 029/02

scharf
pointed
afilado
coupant
tagliente



1/1

HIRSCHMANN
KP 030/13
12,5 cm/5"

Linsenkernwender, Linsenmanipulator
 Lens Nucleus Rotators, Lens Manipulators
 Ganchos para voltear nucleo y para posicionar cristalino
 Crochets pour tourner, Crochets manipulateurs à cristallin
 Uncinetti per rotazione di nucleo cristallino, Uncini per posizionare cristallino

TITANIUM



BECHERT
 KP 040/01
 12,0 cm/4³/₄"
 L = 7 mm

V-Spitze
 V-tip
 punta V
 coudé à fourche
 punta V



JAFFE-BECHERT
 KP 040/02
 12,0 cm/4³/₄"
 L = 9 mm

V-Spitze
 V-tip
 punta V
 coudé à fourche
 punta V



CLAYMAN
 KP 040/03
 12,5 cm/5"
 L = 10 mm

V-Spitze
 V-tip
 punta V
 coudé à fourche
 punta V

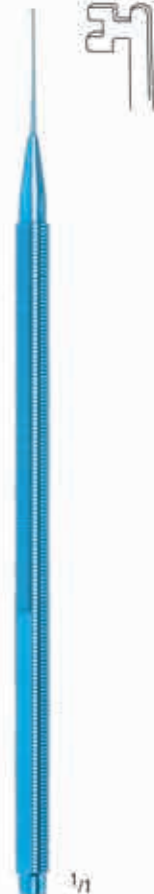

OSHER
 KP 050/12
 12,0 cm/4³/₄"



Linsenkernmanipulatoren, Phakohaken
 IOL Manipulators, Phaco Splitter
 Ganchos para manipular de nucleo, Ganchos para faco
 Crochets pour manipuler le noyau, Crochets à phaco
 Uncini per posizionare cristallino, Uncini per faco

AA

AB

AC

AD

AE

AK

AR

KA

KM

KD

KP

XR

TITANIUM



DRYSDALE
 KP 051/12
 12,0 cm/4³/₄"



BUNNKATU
 KP 057/12
 12,0 cm/4³/₄"

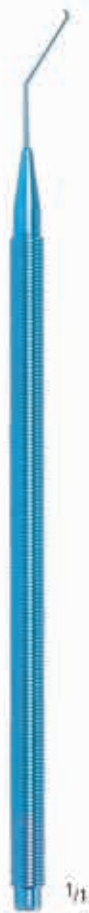

Klinge
 blade
 hoja
 lame
 lame

60°

Klinge
 blade
 hoja
 lame
 lame

60°



ROSEN

12,0 cm/4³/₄"

KP 065/60

KP 065/90

stumpfes Eck
 blunt edge
 canto romo
 coin mousse
 angolo smussato



NAGAHARA

12,0 cm/4³/₄"

KP 067/60

KP 067/90

stumpfes Eck
 blunt edge
 canto romo
 coin mousse
 angolo smussato

IOL Positionshäkchen
 Lens Manipulators
 Ganchos para posicionar cristalino
 Crochets manipulateurs à cristallin
 Uncini per posizionare cristallino

TITANIUM

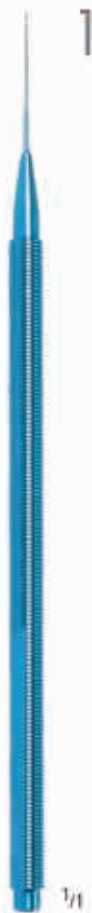

KP 070/20
 KP 070/25

SINSKEY
 12,0 cm/4³/₄"

Ø 0,20 mm
 Ø 0,25 mm

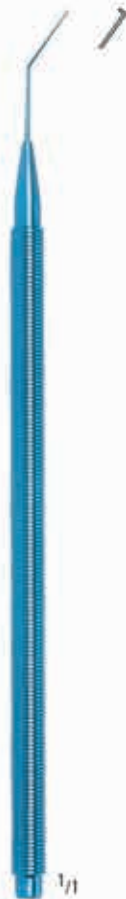

KP 071/20
 KP 071/25

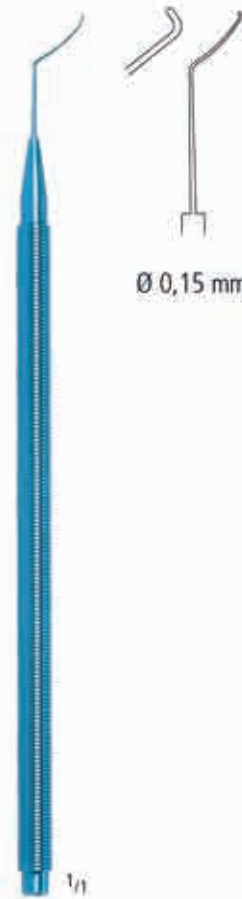

LEWICKY
 KP 075/15
 12,0 cm/4³/₄"

IOL Positionshäkchen
 Lens Manipulators
 Ganchos para posicionar cristalino
 Crochets manipulateurs à cristallin
 Uncini per posizionare cristallino

AA
 AB
 AC
 AD
 AE
 AK
 AR
 KA
 KM
 KO
 KP
 XR

TITANIUM

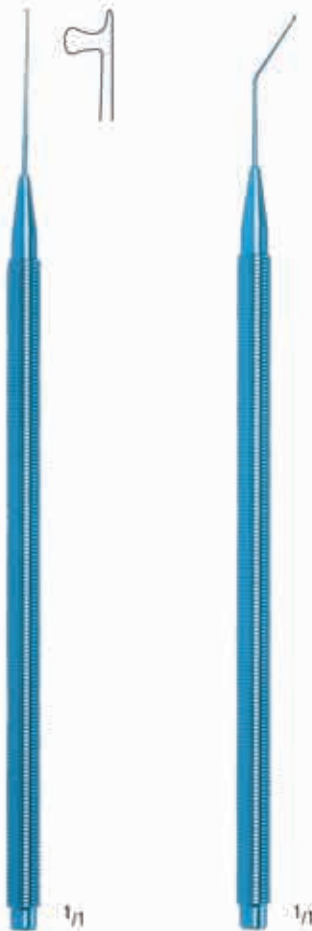

LESTER
 KP 077/01
 12,0 cm/4³/₄"



LESTER
 KP 077/02 12,0 cm/4³/₄" KP 077/03 12,0 cm/4³/₄"

gewölbt
 vaulted
 abovedado
 cintré
 convesso



JAFFE-MALTZMANN
 KP 081/12
 12,0 cm/4³/₄"

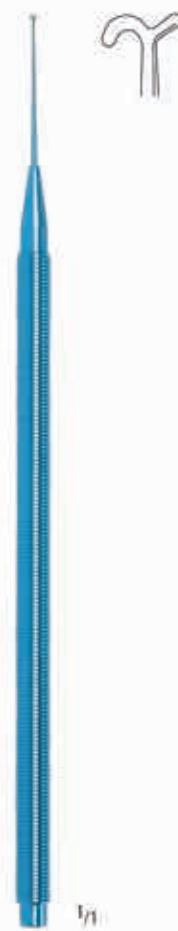

RENTSCH
 KP 085/12
 12,0 cm/4³/₄"

Tränenkanalsonden
 Lacrimal Probes
 Sondas exploradoras para canal lacrimal
 Sondes exploratrices pour le canal lacrymal
 Sonde esploratrici per canale lacrimale

AA
AB
AC
AD
AE
AK
AR
KA
KM
KD
KP
XR



geknöpft
pointed
con botón
boutonné
bottenuto

- KP 114/00
- KP 115/00
- KP 115/01
- KP 115/12
- KP 115/23
- KP 115/34
- KP 115/45
- KP 115/56
- KP 115/67
- KP 115/78

Fig.	mm Ø
0000/00	0,4 / 0,6
00/0	0,7 / 0,8
0/1	0,8 / 0,9
1/2	0,9 / 1,1
2/3	1,1 / 1,3
3/4	1,3 / 1,4
4/5	1,4 / 1,5
5/6	1,5 / 1,6
6/7	1,6 / 1,8
7/8	1,8 / 1,9

BOWMAN
12,5 cm/5"

aus Silber
Sterling silver
de plata pura
en argent pur
in argento puro



zylindrisch
cylindrical
cilindrica
cylindrique
cilindrico

- KP 116/00
- KP 117/00
- KP 117/01
- KP 117/12
- KP 117/23
- KP 117/34
- KP 117/45
- KP 117/56
- KP 117/67
- KP 117/78



BOWMAN
12,5 cm/5"

Tränenkanaldilatatoren
 Lacrimal Dilators
 Dilatadoras para canal lacrimal
 Dilatateurs pour le canal lacrymal
 Dilatatori per canale lacrimale

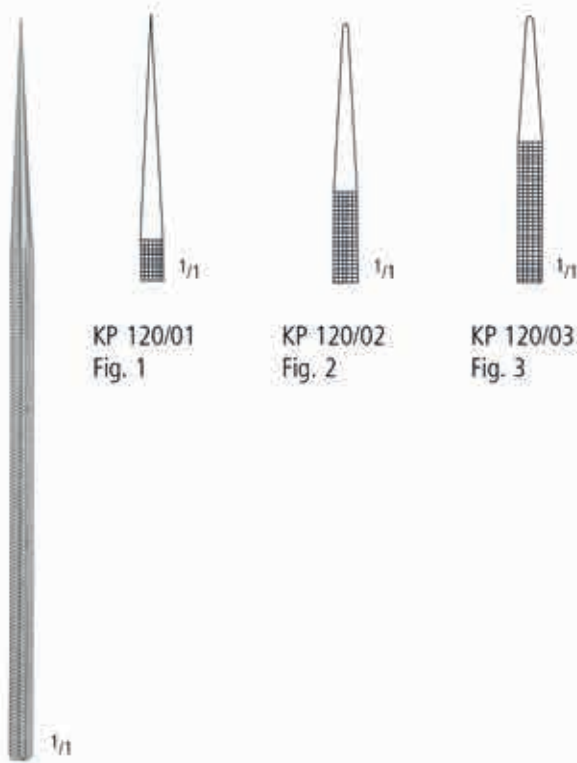

KP 120/01
Fig. 1

KP 120/02
Fig. 2

KP 120/03
Fig. 3

WILDER
10 cm/4"



MULDOON
KP 121/11
10,5 cm/4 1/4"

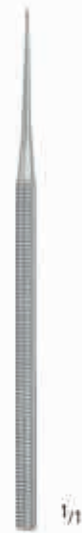

RUEDEMANN
KP 122/07
7 cm/2 3/4"

Tränenkanaldilatatoren, Trabekularsonden, Pigtail Sonde
 Lacrimal Dilators, Trabecular Probes, Pigtail Probe
 Dilatadoras para canal lacrimal, Sondas trabeculares, Sonda pigtail
 Dilatateurs pour le canal lacrymal, Sondes trabéculaires, Sonde spiralée
 Dilatatori per canale lacrimale, Sonde trabecolari, Sonda a pigtail

AA
AB
AC
AD
AE
AK
AR
KA
KM
KD
KP
XR



CASTROVIEJO
 KP 123/14
 14 cm/5 1/2"



KP 130/01
 rechts
 right
 derecha
 droit
 destra



HARMS
 4,5 cm/1 3/4"

KP 130/02
 links
 left
 izquierda
 gauche
 sinistra

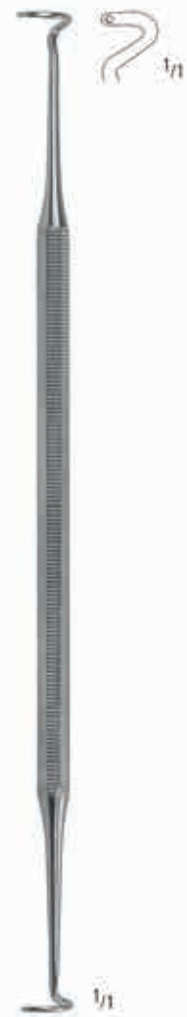

WORST
 KP 135/14
 13,5 cm/5 1/4"

Lidsperrer
Eye Specula
Blefarostatos
Blépharostats
Blefarostati

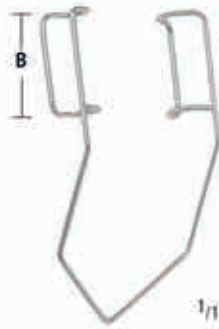

BARRAQUER-COLIBRI

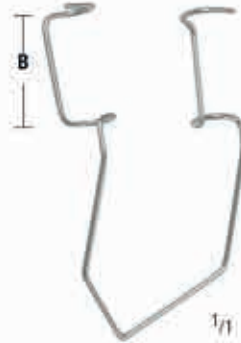

KRATZ-BARRAQUER



BARRAQUER

geschlossene Valven
solid blades
hojas sólidas
cuillers plaines
valve massiccio

Frühgeborene
Premature infant
Parto prematuro
Accouchement prématuré
Parto prematuro

B
5 mm KP 150/05
3,0 cm/1¹/₄"

B
10 mm KP 151/10
4,0 cm/1¹/₂"

B
10 mm KP 152/10
4,0 cm/1¹/₂"

Kind
Child
Niños
Enfants
Bambini

10 mm KP 150/10
3,0 cm/1¹/₄"

10 mm KP 151/10
4,0 cm/1¹/₂"

10 mm KP 152/10
4,0 cm/1¹/₂"

Erwachsene
Adults
Adultos
Adultes
Adulti

15 mm KP 150/15
4,0 cm/1¹/₂"

14 mm KP 151/14
4,5 cm/1³/₄"

15 mm KP 152/15
4,0 cm/1¹/₂"



BARRAQUER PHAKO
KP 154/04
4,0 cm/1¹/₂"



BOWMAN
KP 160/07
7,0 cm/2³/₄"



CORCELLE
KP 161/05
5,0 cm/ 2"
B = 8 mm



WILLIAMS
KP 162/09
9,0 cm/3¹/₂"
B = 14 mm

Lidsperrer
Eye Specula
Blefarostatos
Blépharostats
Blefarostati

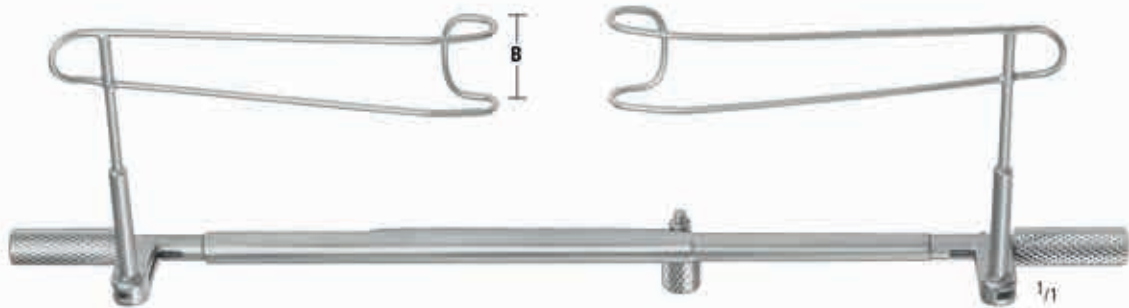

SCHOTT
15,0 cm/6"

Kind
Child
Niños
Enfants
Bambini

B
12 mm KP 170/12

Erwachsene
Adults
Adultos
Adultes
Adulti

B
15 mm KP 170/15



CASTROVIEJO
KP 175/09
9,0 cm/3½"
B = 16 mm



MAUMENEE-PARK
KP 176/09
8,5 cm/3¼"



MAUMENEE-PARK
KP 177/09
8,5 cm/3¼"

AA
AB
AC
AD
AE
AK
AR
KA
KM
KD
XR
KP

Lidsperrer
Eye Specula
Blefarostatos
Blépharostats
Blefarostati



PLEY
KP 185/07
6,5 cm/2 1/2"



LANCASTER
KP 186/08
8,0 cm/3 1/4"



LESTER-BURCH
KP 187/08
8,0 cm/3 1/4"



COOK

	B	
Kind Child Niños Enfants Bambini	10 mm	KP 200/10 4,0 cm/1 1/2"
Erwachsene Adults Adultos Adultes Adulti	15 mm	KP 200/15 5,0 cm/ 2"



SAUER

	B	
Kind Child Niños Enfants Bambini	8 mm	KP 205/08 3,0 cm/1 1/4"

Lidsperrer
Eye Specula
Blefarostatos
Blépharostats
Blefarostati



V-förmig
V-shaped
forma V
forme V
forme V

LIEBERMAN
KP 210/01
8,0 cm/3¹/₄"
B = 15 mm



K-förmig
K-shaped
forma K
forme K
forme K

LIEBERMAN
KP 210/02
8,0 cm/3¹/₄"
B = 15 mm



LIEBERMAN
KP 211/08
8,0 cm/3¹/₄"
B = 15 mm



LIEBERMAN
KP 212/08
8,0 cm/3¹/₄"
B = 15 mm

AA

AB

AC

AD

AE

AK

AR

KA

KM

KD

KP

XR

Tränensackspreizer, Lidplatte
 Lacrimal Sac Retractors, Lid Plate
 Separadores para saco lacrimal, Placa para párpados
 Ecarteurs à sac lacrymal, Plaque à paupières
 Divaricatore per sacco lacrimale, Elevatori per palpebre



STEVENSON
 KP 230/08
 7,5 cm/3"



AGRICOLA
 KP 232/05
 4,5 cm/1³/₄"



Paar
 Pair
 Par
 Paire
 Paio

JAFFE
 4,0 cm/1¹/₂"



JAEGER
 KP 248/11
 11,0 cm/4¹/₂"

B
 10 mm KP 245/10
 Kind
 Child
 Niños
 Enfants
 Bambini

B
 15 mm KP 245/15
 Erwachsene
 Adults
 Adultos
 Adultes
 Adulti

Orbitalretractoren und -spatel, Wundlöffel
 Orbital Retractors and Spatulas, Protector
 Separadores y espátulas orbitales, Protector
 Ecarteurs et spatules à orbite, Protecteur
 Divaricatori orbitale, Spatole per orbita, Protettore

AA

AB

AC

AD

AE

AK

AR

KA

KM

KD

KP

XR

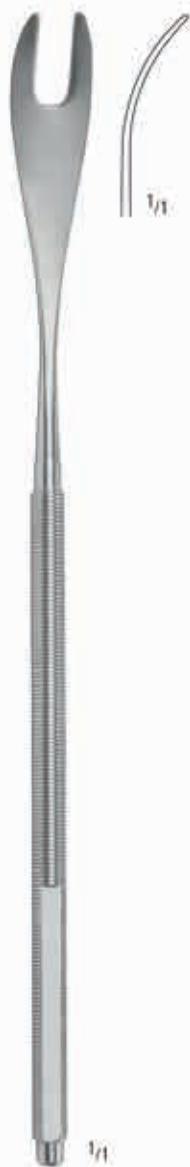

SCHEPENS
 KP 260/16
 15,5 cm/6¹/₄"



SAUTER
 KP 261/15
 15,0 cm/6"



ARRUGA
 KP 262/13
 13,0 cm/5"



LASIK
 KP 270/10
 10,0 cm/4"

Depressor, Sklera Marker
 Depressors, Scleral Markers
 Depresores, Marcadores de esclerótica
 Dépresseurs, Marqueur scléral
 Depressore; Marcadori sclerali



SCHOCKET
 KP 280/14
 14,0 cm/5 1/2"



GASS
 KP 285/05
 4,5 cm/1 3/4"
 Ø 1,5 mm



KP 290/08
 Fig. 8

klein
 small
 pequeño
 petit
 piccolo

SCHEPENS
 4,0 cm/1 1/2"

KP 290/10
 Fig. 10

medium
 medium
 medio
 moyen
 medio

KP 290/12
 Fig. 12

groß
 large
 grande
 grand
 grande

Hornhautmesser und -schaber, Diszisionmesser
 Corneal Knives and Scarifiers, Discission Knives
 Cuchillos y Rescadores para la córnea, Cuchillos para discisión
 Kératomes, Grattoirs cornéens, Couteaux à discision
 Coltelli per cornea, Raschiatoi corneali, Coltelli per discissione



SATO
 KP 300/12
 12,0 cm/ 4³/₄"
 5 mm



GILL
 KP 302/13
 12,5 cm/4¹/₂"
 3 mm

gerade
 straight
 recto
 droit
 rette



KP 303/12
 11,5 cm/ 5"
 3 mm

gebogen
 curved
 curvas
 courbes
 curve



TOOK
 KP 305/11
 11,0 cm/ 4¹/₄"
 3 x 18 mm



KUHNT
 KP 309/11
 11,0 cm/ 4¹/₄"
 3 x 5 mm



ZIEGLER
 11,0 cm/ 4¹/₄"
 KP 310/03
 3 mm



KP 310/05
 5 mm



WHEELER
 KP 312/11
 11,0 cm/ 4¹/₄"
 1 x 18 mm

Star-, Sklera-, Goniotomiemesser
 Cataract, Sclera and Goniotomy Knives
 Cuchillos para catarata, para esclerótica, para goniotomía
 Couteaux à cataracte, pour la sclère, à goniotomie
 Coltelli per cataratta, sclerali e per goniotomia



GRAEFE



KP 320/20
 12,0 cm/ 4³/₄"
 20 mm



KP 320/25
 12,5 cm/ 5"
 25 mm

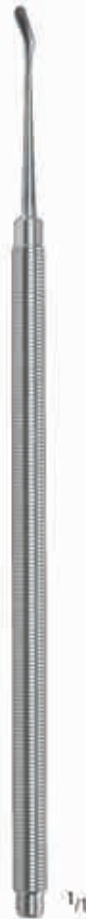

BONN



KP 325/05
 12,5 cm/ 5"
 5 mm



KP 325/06
 12,5 cm/ 5"
 6 mm



BARKAN
 KP 330/12
 12,0 cm/ 4³/₄"
 2 mm



Luftlanze, Keratoplastikmesser, Zystotome
 Keratome, Keratoplasty Knives, Cystotomes
 Querátomo, Cuchillos para queratoplástica, Quistótomos
 Couteaux lancéolaires, Couteaux pour kératoplastie, Cystotomes
 Coltelli lanceolari, Coltelli per cheratoplastica, Cistotomi

AA

AB

AC

AD

AE

AK

AR

KA

KM

KD

KP

XR

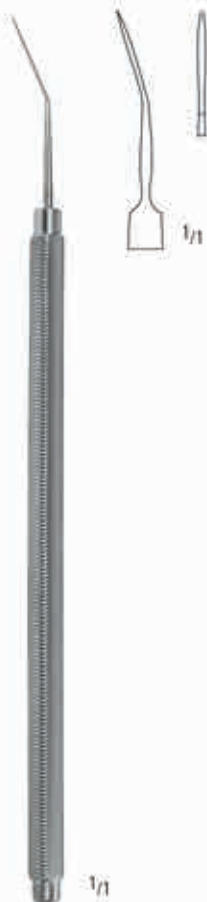

MOD. HAMBURG
 KP 335/12
 12,0 cm / 4³/₄"



PAUFIQUE
 KP 340/11
 10,5 cm / 4¹/₄"



GRAEFE
 KP 346/13
 12,5 cm / 5"

biegsam
 malleable
 maleable
 malleable
 malleabile

Fremdkörpernadeln, -hohlmeißel und -meißel
 Foreign Body Needles, Gouges and Spuds
 Agujas, Gubias y Cinceles para cuerpos extraños
 Aiguilles, Gouges et Ciseaux-burins à corps étrangers
 Aghi, Sgorbie e Scalpelli per corpi estranei



KP 350/12

umschraubbar
 reversible
 reversible
 révisible
 rivoltabile

KP 350/13

umschraubbar
 reversible
 reversible
 révisible
 rivoltabile



KP 351/01



KP 351/02



KP 351/03

Fremdkörpernadeln und -meißel
 Foreign Body Needles and Spuds
 Aguja y Cinceles para cuerpos extraños
 Aiguilles et Ciseaux-burins à corps étrangers
 Aghi e Scalpelli per corpi estranei

AA
AB
AC
AD
AE
AK
AR
KA
KM
KO
KP
XR



KP 354/12
 12,0 cm/ 4³/₄"



KP 355/12
 12,0 cm/ 4³/₄"



DAVIS
 KP 360/12
 12,0 cm/ 4³/₄"

scharf, rund
 sharp, round
 afilado, redondo
 coupant, rond
 tagliente, rotondo



ELLIS
 KP 361/12
 11,5 cm/4¹/₂"

gebogen, rund
 curved, round
 curvado, redondo
 courbe, rond
 curvo, rotondo



FRANCIS
 KP 363/12
 12,0 cm/ 4³/₄"



GOLF-CLUB
 KP 364/12
 11,5 cm/4¹/₂"

Fremdkörpernadeln, -hohlmeißeln und -meißeln, Augenmagnet mit Fremdkörperschlinge
 Foreign Body Needles, Gouges and Spuds, Magnetic Eye Probe with Foreign Body Loop
 Agujas, Gubias y Cinceles para cuerpos extraños, Imán oftálmico con asa para cuerpos extraños
 Aiguilles, Gouges et Ciseaux-burins à corps étrangers, Aimant oculaire avec anse pour corps étrangers
 Aghi, Sgorbie e Scalpelli per corpi estranei, Calamita per occhi con ansa per corpi estranei

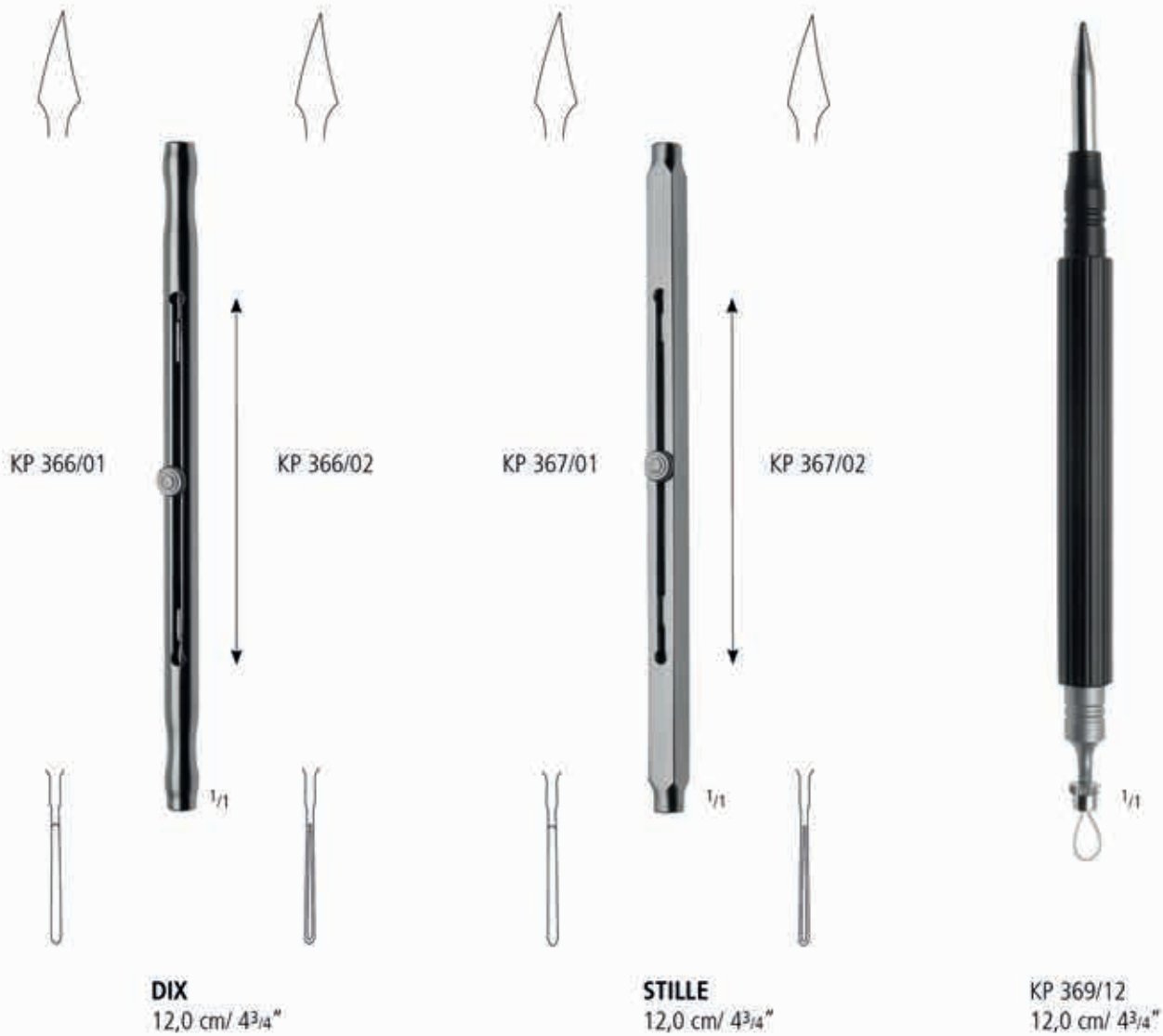

Diamantmesser
 Diamond Knives
 Bisturis de diamante
 Couteaux de diamant
 Coltelli di diamanti

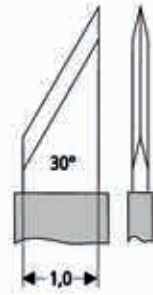

KP 370/01

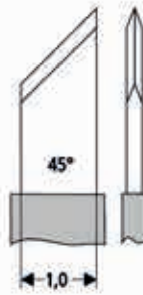

KP 370/02

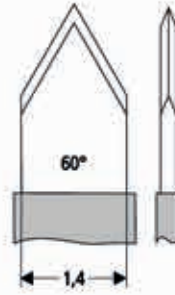

KP 370/03

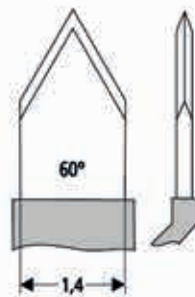

KP 370/04

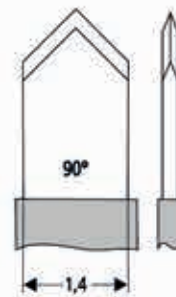

KP 370/05

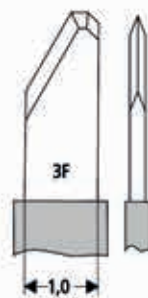

KP 371/01

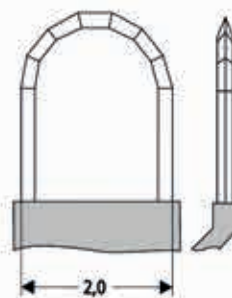

KP 371/02



1/1

AA

AB

AC

AD

AE

AK

AR

KA

KM

KO

KP

XR

Diamantmesser
Diamond Knives
Bisturis de diamante
Couteaux de diamant
Coltelli di diamanti

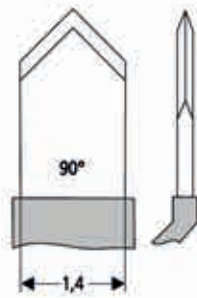

KP 373/01

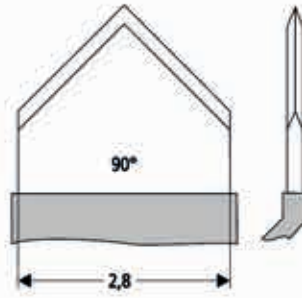

KP 373/02

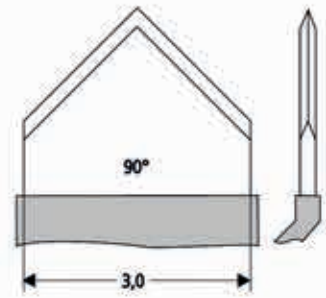

KP 373/03

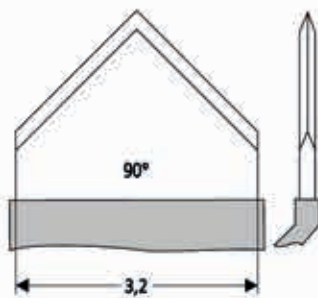

KP 373/04

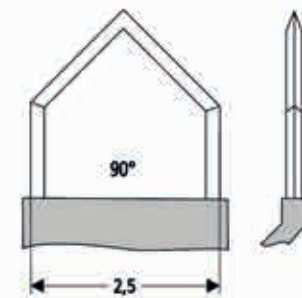

KP 373/05

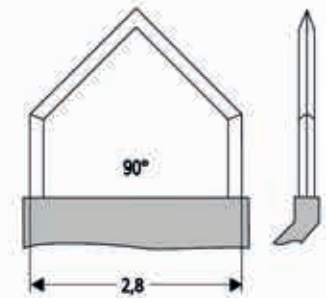

KP 373/06

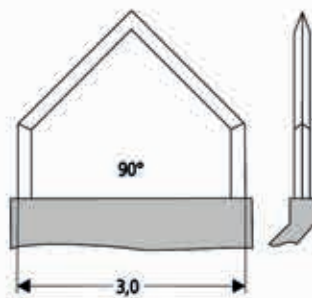

KP 373/07

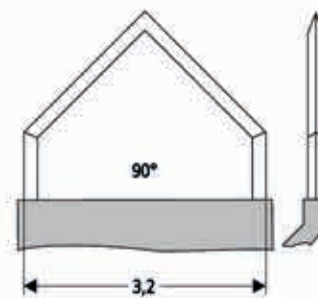

KP 373/08

Diamantmesser
Diamond Knives
Bisturis de diamante
Couteaux de diamant
Coltelli di diamanti

AA

AB

AC

AD

AE

AK

AR

KA

KM

KD

KP

XR



1/1

mit Mikrometer
with micrometer
con micrometro
avec micromètre
con micrometro



KP 375/01

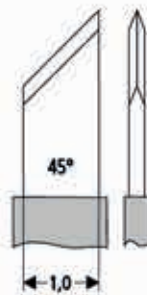

KP 375/02

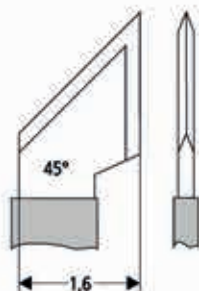

KP 375/03

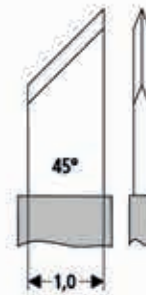

KP 376/01



1/1

7 Stufen:
7 steps:
7 escalones:
7 étages:
7 gradi:

0 / 0,3 / 0,4 / 0,5 / 0,6 / 0,8 / 1,0 / 2,5 mm

Vitrektomiescheren
 Vitrectomy Scissors
 Tijeras de vitrectomía
 Ciseaux pour vitrectomie
 Forbici per vitrectomia



ohne Spülung
 without irrigation
 sin irrigació
 sans irrigation
 senza irrigazione

mit Spülung
 with irrigation
 con irrigació
 avec irrigation
 con irrigazione



KP 390/00
 0°



KP 390/30
 30°



60° KP 390/60
 90° KP 390/90

Vitrektomiefasszangen
 Vitrectomy Grasping Forceps
 Pinzas de vitrectomia
 Pincas pour vitrectomie
 Pinze per vitrectomia

AA
 AB
 AC
 AD
 AE
 AK
 AR
 KA
 KM
 KD
 KP
 XR



KP 394/00



KP 395/01



KP 395/02



KP 395/03



0,30 mm KP 396/30
 0,44 mm KP 396/44



KP 397/45
 45°



KP 397/90
 90°

Exenterations- und Enukleationslöffel
 Exenteration- and Enucleation Spoons
 Cucharas para exenteración y para enucleación
 Cuillers à éviscération et à énucléation
 Cucchiari da enucleazione

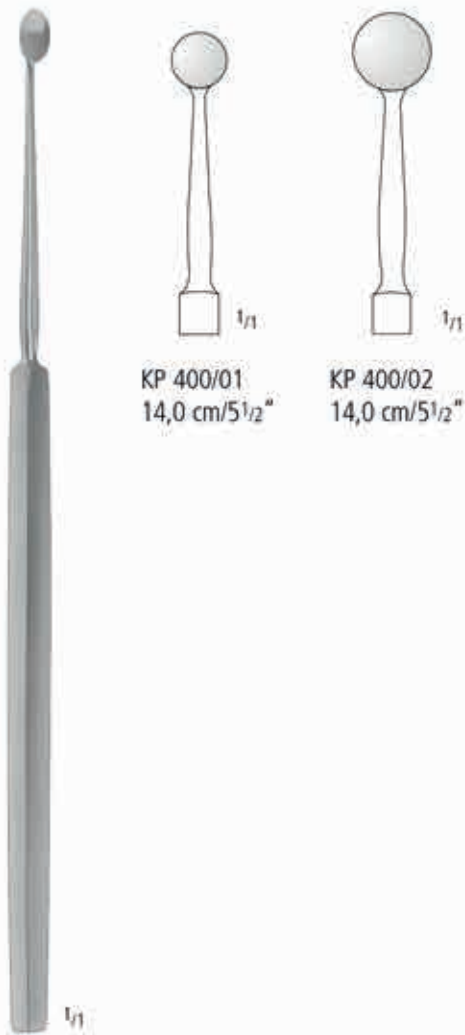

KP 400/01
14,0 cm/5 1/2"

KP 400/02
14,0 cm/5 1/2"

BUNGE

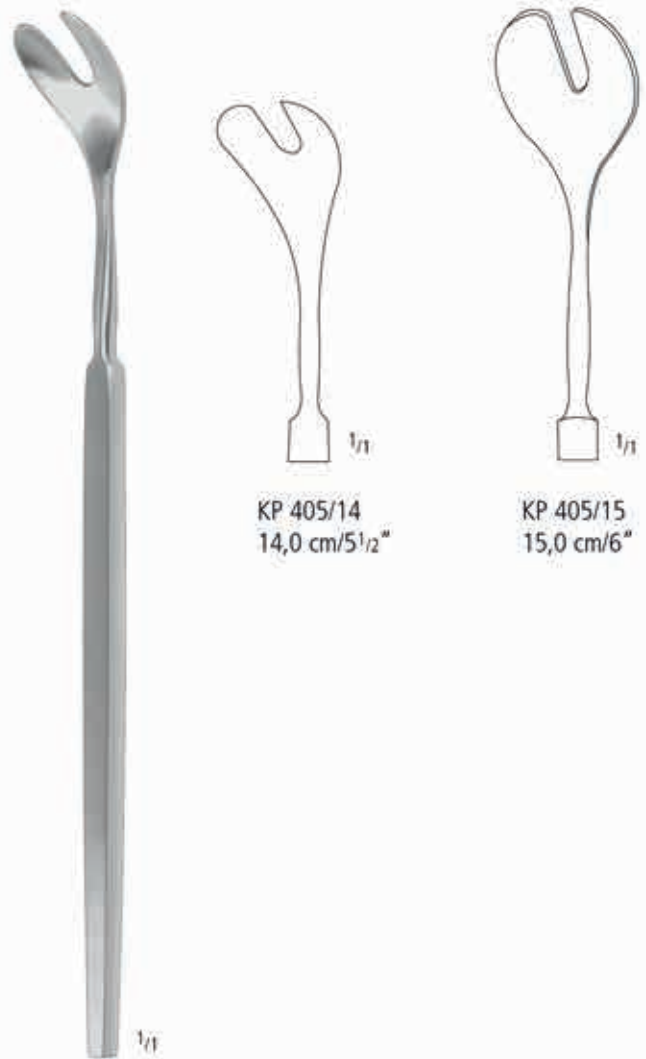

KP 405/14
14,0 cm/5 1/2"

KP 405/15
15,0 cm/6"

WELLS

Starlöffel, Chalazionlöffel
 Corneal Button Transfer Spoon, Chalazion Curettes
 Cucharas para transferir la córnea, Cucharillas para chalazión
 Cuillers pour transférer la cornée, Cuillers à chalazion
 Anse per cristallino, Cucchiari per calazio

AA

AB

AC

AD

AE

AK

AR

KA

KM

KD

KP

XR



KNAPP
 KP 410/14
 13,5 cm/5 1/4"

für Hornhauttransfer
 for corneal button transfer
 para transferir la córnea
 pour transférer la cornée
 per trasferire la cornea

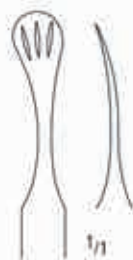

CASTROVIEJO
 KP 411/12
 12,0 cm/4 3/4"



MEYHOEFER
 13,0 cm/5"



KP 415/10
 Ø 1,0 mm



KP 415/15
 Ø 1,5 mm



KP 415/18
 Ø 1,8 mm



KP 415/20
 Ø 2,0 mm



KP 415/25
 Ø 2,5 mm



KP 415/30
 Ø 3,0 mm



KP 415/35
 Ø 3,5 mm

Chalazionlöffel, Starlöffel, Starschlingen
 Chalazion Curettes, Cataract Spoons, Lens Scoops
 Cucharillas para chalazión y para catarata, Asas para catarata
 Cuillers à chalazion et à cataracte, Anses à cataracte
 Cucchiari per calazio, Cucchiari per cataratta, Anse per cataratta

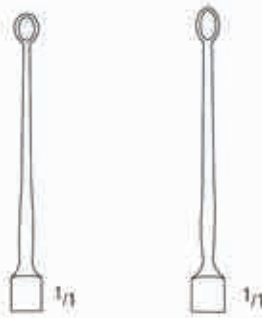

HEBRA
 13,0 cm/5"
 KP 417/20 KP 417/25
 Ø 2,0 mm Ø 2,5 mm



GRAEFE
 KP 425/14
 13,5 cm/5 1/4"



DAVIEL
 KP 427/12
 12,0 cm/4 3/4"
 3 x 14 mm



SNELLEN
 KP 440/13
 13,0 cm/5"



ARLT
 KP 442/13
 13,0 cm/5"



LEWIS
 13,0 cm/5"
 KP 443/01 KP 443/02
 4,0 mm 4,7 mm



NEW ORLEANS
 KP 450/13
 13,0 cm/5"

Positionsspatel, Linsenkerntspatel
 Lens Spatulas, Nucleus Spatulas
 Espátulas para manipular, Espátulas para núcleo cristalino
 Spatules pour manipuler, Spatules pour noyau
 Spatole per manipolare, Spatole per nucleo cristallino

AA
AB
AC
AD
AE
AK
AR
KA
KM
KO
KP
XR



JAFFE
 KP 470/12
 12,0 cm/ 4³/₄"
 0,5 mm



OBSTBAUM
 KP 471/12
 12,0 cm/ 4³/₄"
 0,25 mm



HIRSCHMANN
 KP 472/13
 12,5 cm/5"



MOD. DORTMUND
 KP 478/12
 12,0 cm/ 4³/₄"
 0,6 x 12 mm



KNOLLE
 KP 480/13
 12,5 cm/5"

TITANIUM



LIPPMAN
 KP 481/12
 12,0 cm/ 4³/₄"



Zyklodialysespatel
 Cyclodialysis Spatulas
 Espátulas para ciclodialisis
 Spatules à cyclodialyse
 Spatole per ciclodialisi

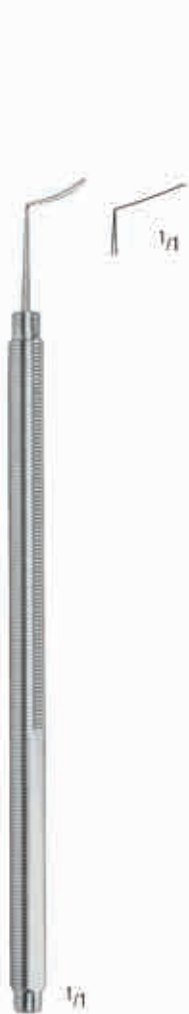

CASTROVIEJO-BARRAQUER
 KP 485/11
 11,0 cm/4 1/2"
 0,5 x 10 mm



CASTROVIEJO
 KP 487/14
 13,5 cm/5 1/4"
 0,5 x 10/16 mm

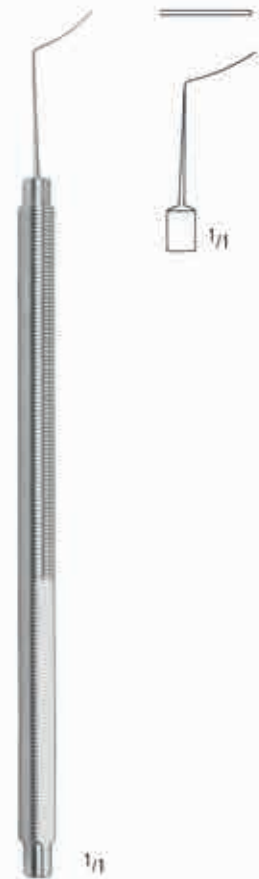

BARRAQUER-FINO
 KP 489/12
 11,5 cm/4 1/2"
 0,25 x 12 mm

Irisspatel
Iris Spatulas
Espátulas para iris
Spatules à iris
Spatole per l'iride

AA

AB

AC

AD

TITANIUM

AE

AK

AR

KA

KM

KD

KP

XR



biegsam
malleable
maleable
malléable
malleabile

WECKER
KP 495/13
13,0 cm/5"
2 mm

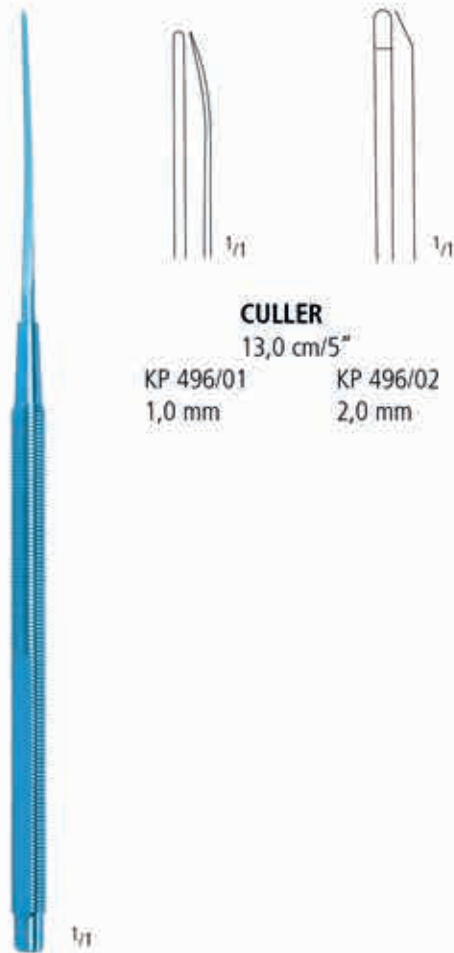

CULLER

13,0 cm/5"

KP 496/01
1,0 mm

KP 496/02
2,0 mm

Markierinstrumente optisches Zentrum, Radial- und Axialmarkierinstrumente
 Optical Zone Markers, Radial and Axis Markers
 Marcadores para centro óptico, Marcadores radiales y axiales
 Marqueurs pour centre optique, Marqueurs radiales et axiales
 Marcatori ottici, Marcatori radiali e assiali

TITANIUM

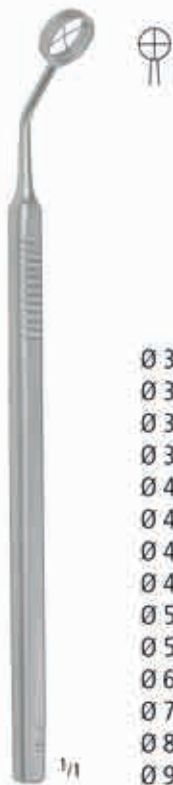

- Ø 3,00 mm KP 500/30
- Ø 3,25 mm KP 500/32
- Ø 3,50 mm KP 500/35
- Ø 3,75 mm KP 500/37
- Ø 4,00 mm KP 500/40
- Ø 4,25 mm KP 500/42
- Ø 4,50 mm KP 500/45
- Ø 4,75 mm KP 500/47
- Ø 5,00 mm KP 500/50
- Ø 5,50 mm KP 500/55
- Ø 6,00 mm KP 500/60
- Ø 7,00 mm KP 500/70
- Ø 8,00 mm KP 500/80
- Ø 9,00 mm KP 500/90

HOFFER
10,0 cm/4"



- 8 Klingen
- 8 blades
- 8 hojas
- 8 lames
- 8 lame

ANIS
KP 505/12
12,0 cm/4³/₄"
Ø 4 mm/12,5 mm

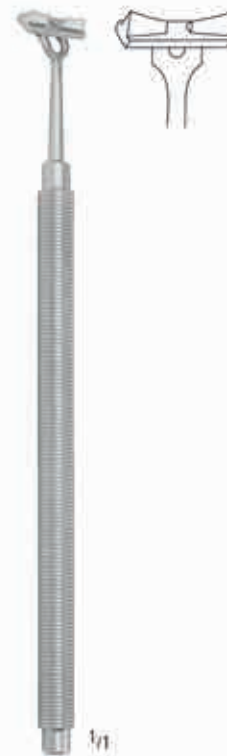

BORES
KP 508/10
10,0 cm/4"

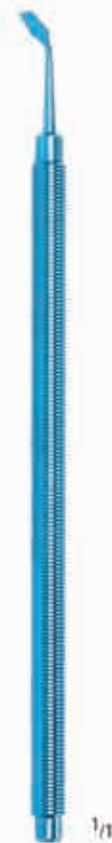

GRANDON
KP 510/11
11,0 cm/4¹/₂"
3 mm

Hornhautmarkierinstrumente
 Corneal Markers
 Marcadores corneales
 Marqueurs cornéens
 Marcatori corneali

AA

AB

AC

AD

AE

AK

AR

KA

KM

KD

KP

XR

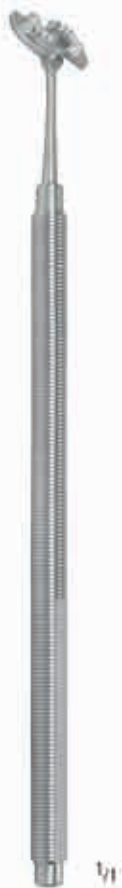

1/1

LINDSTROM
 KP 515/12
 12,0 cm/4³/₄"
 7 mm



1/1

LU
 KP 516/11
 10,5 cm/4¹/₄"
 Ø 8,5 mm



1/1

KP 518/10
 10,0 cm/4"



1/1

4+1 Klingen
 4+1 blades
 4+1 hojas
 4+1 lames
 4+1 lame

KP 519/10
 10,0 cm/4"
 Ø 5 + 11 mm

Hornhaut-, Limbus Inzisions-, Nahtplatzierungsmarkierinstrumente
 Corneal Markers, Limbal Incision Rulers, Suture Placement Markers
 Marcadores corneales, para incisión limbal y para suturas
 Marqueurs pour kéroplastie, pour incision limbique et à sutures
 Marcatori corneali, per incisione in limbo e per sutura



THORNTON
 KP 523/12
 12,0 cm/4³/₄"
 6-8 mm / 0,5-5,0 mm

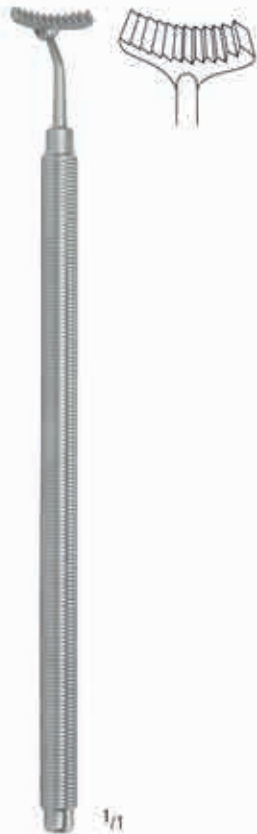

THORNTON
 KP 530/11
 11,0 cm/4¹/₂"
 1-10 mm



ANIS
 KP 535/12
 12,0 cm/4³/₄"



GONNIN
 KP 540/13
 13,0 cm/5"
 11-23 mm / 1 mm

Tonometer, Keratometer
 Tonometers, Keratometer
 Tonómetros, Queratómetro
 Tonomètres, Kératomètre
 Tonometri, Cheratometro



SCHIOETZ
 13,0 cm/5"

gerade Skala
 straight scale
 graduado recto
 échelle droite
 scala retta

schräge Skala
 inclined scale
 graduado inclinado
 échelle oblique
 scala inclinata

Spezifikation Nr. 3
 Specification No. 3
 Especificación No. 3
 Spécification No. 3
 Specifica No. 3

KP 543/00

Spezifikation Nr. 5, geeicht
 Specification No. 5, calibrated
 Especificación No. 5, calibrada
 Spécification No. 5, calibrée
 Specifica No. 5, calibrata

KP 542/01

KP 543/01



MALONEY
 KP 545/02
 2,0 cm³/₄"

AA

AB

AC

AD

AE

AK

AR

KA

KM

KD

KP

XR

Messinstrumente, Tiefenlehre, Fixierringe
 Measuring Instruments, Depth Gauge, Fixation Rings
 Instrumentos de medición, Medidor de profundidad, Anillos de fijación
 Instruments de mesure, Jauge de profondeur, Anneaux de fixation
 Strumenti per la misurazione, Misuratori di profondità, Anelli di fissazione



MENDEZ
 KP 547/11
 11,0 cm/4 1/2"
 C 10°, 0 -180°



DEITZ
 9,5 cm/3 3/4"
 KP 548/50 KP 548/55
 0,50 mm 0,55 mm



THORNTON
 KP 550/12
 12,0 cm/4 3/4"
 Ø 13 mm



BONN
 KP 555/11
 10,5 cm/4 1/4"

Hornhautbohrer und -trephinen
 Corneal Burrs and Trephines
 Fresas y trépanos corneales
 Trépanos kératoplastie
 Trepani corneali

AA

AB

AC

AD

AE

AK

AR

KA

KM

KD

KP

XR



1/1

CASTROVIEJO
 5,0 cm/2"

mm Ø

5,0	KP 600/50
5,5	KP 600/55
6,0	KP 600/60
6,5	KP 600/65
7,0	KP 600/70
7,5	KP 600/75
8,0	KP 600/80
9,0	KP 600/90



1/1

FRANCESCHETTI
 7,5 cm/3"

mm Ø

7,0	KP 603/70
7,1	KP 603/71
8,0	KP 603/80
8,1	KP 603/81



1/1

MARTIN
 4,0 cm/1 1/2"

mm Ø

5,0	KP 605/50
5,5	KP 605/55
6,0	KP 605/60
6,5	KP 605/65
6,7	KP 605/67
7,0	KP 605/70
7,2	KP 605/72
7,5	KP 605/75

mm Ø

7,7	KP 605/77
8,0	KP 605/80
8,2	KP 605/82
8,5	KP 605/85
8,7	KP 605/87
9,0	KP 605/90
9,5	KP 605/95

Hornhautbohrer und -trephinen
 Corneal Burrs and Trephines
 Fresas y trépanos corneales
 Trépanis kératoplastie
 Trepani corneali



ELLIOT
 KP 611/00
 3,0 cm/1 1/4"



ELLIOT
 KP 612/10
 Ø 1,0 mm



ELLIOT
 KP 612/15 KP 612/20
 Ø 1,5 mm Ø 2,0 mm

ELLIOT SET

KP 610/00 = KP 611/00
 KP 612/10
 KP 612/15
 KP 612/20

mit Etui
 with case
 con estuche
 avec boîte
 con scatola



mit 6 Fräsen
 with 6 burrs
 con 6 fresas
 avec 6 fraises
 con 6 fresas

STORZ
 KP 620/08
 8,0 cm/3 1/4"

Rostringfräse, Fixierringe,
Rust Ring Remover, Scleral Fixation Rings
Anillo removedor de óxido, Anillos de fijación
Fraise pour enlever la rouille, Anneaux de fixation
Fresa corneale, Anelli di fissazione



**RUST RING
REMOVER SET**
KP 630/00
12,5 cm/5"



KP 631/00
6 Fräsen
6 burrs
6 fresas
6 fraises
6 fresas

KP 632/00
Batterie, 2 Stück
Battery, 2 pieces
bateria, 2 piezas
piles, 2 pièces
pile, 2 pezzi

KP 630/00 = KP 631/00 + KP 632/00



FLIERINGA

mm Ø	
14	KP 640/14
16	KP 640/16
18	KP 640/18
20	KP 640/20
22	KP 640/22
24	KP 640/24

AA

AB

AC

AD

AE

AK

AR

KA

KM

KD

KP

XR

Vorderkammerspülkanülen, Silikonball, Verbindung, Spülkanülen
 Anterior Chamber Irrigation Cannula, Silicon Ball, Connection, Irrigation Cannulas
 Cánulas de irrigación para cámara anterior, Pelota de silicona, Conector, Cánulas para irrigación
 Canules à lavage pour chambre antérieure, Balle de silicone, Raccord, Canules irrigatrices
 Cannule d'irrigazione per camera anteriore, Palla di silicone, Raccordo, Cannule d'irrigazione



BISHOP-HARMON
 KP 700/00

Set komplett
 Set complete
 Juego completo
 Jeu complet
 Set completo

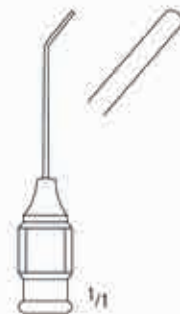

BISHOP-HARMON
 KP 701/19
 4,0 cm/1 1/2"
 19G



KP 702/00
 7,5 cm/2 3/4"

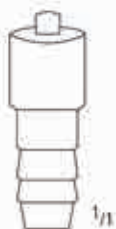

LUER-LOCK
 KP 703/00
 3,0 cm/1 1/4"



McINTYRE
 KP 704/23
 3,0 cm/1 1/4"
 23G



MODELL BONN
 4,0 cm/1 1/2"
 KP 705/19 KP 705/20
 19G 20G

Vorderkammer-, Saug- und Spülkanülen, Luftkanülen
 Anterior Chamber, Irrigation and Aspiration Cannulas, Air Injection Cannulas
 Cánulas para cámara anterior, irrigación y aspiración, Cánulas para inyectar aire
 Canules à chambre antérieure, irrigatrices et pour aspiration, Canules à injection d'air
 Cannule per camera anteriore, d'irrigazione e d'aspirazione, Cannule per iniettare aria

AA
AB
AC
AD
AE
AK
AR
KA
KM
KO
KP
XR

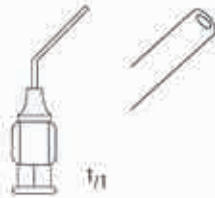

McINTYRE
 2,5 cm/1"
 KP 712/27 27G KP 712/30 30G

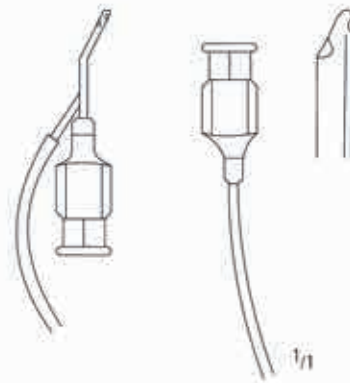

SIMCOE
 KP 720/23
 3,0 cm/1 1/4"
 25/23G

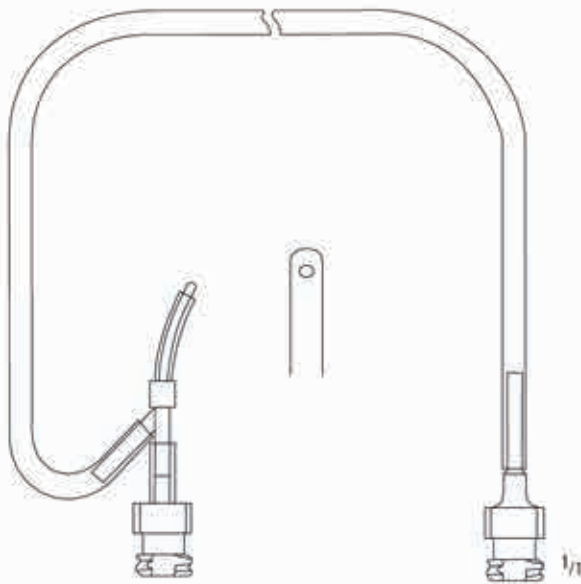

FRIEDBURG
 KP 721/00
 4,0 cm/1 1/2" 3,0 cm/1 1/4"



SAUTTER
 KP 730/27 27G KP 730/30 30G
 3,5 cm/1 1/2"



SAUTTER
 KP 731/27
 3,5 cm/1 1/2"
 27G

Tränenwegkanülen, Kortex Extraktor
 Lacrimal Cannulas, Cortex Extractor
 Cánulas lacrimales, Extractor para corteza
 Canules à voies lacrymales, Extracteur de cortex
 Cannules per vie lacrimali, Estrattore per capsula



ANEL
 KP 740/23
 4,0 cm/1 1/2"
 23G



KP 741/23
 3,5 cm/1 1/2"
 23G

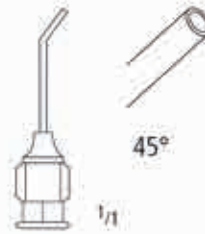

GILLS-WELSH
 KP 745/25
 3,0 cm/1 1/4"
 25G



SIMCOE
 KP 746/23
 3,0 cm/1 1/4"
 23G

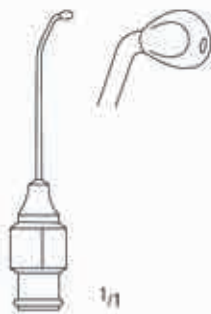

WELSH
 KP 747/00
 4,0 cm/1 1/2"
 25G



WELSH
 KP 747/01
 4,0 cm/1 1/2"
 25G

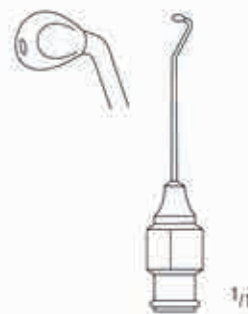

WELSH
 KP 747/02
 4,0 cm/1 1/2"
 25G

Linsenschlinge und Linsenkernschlinge mit Spülung, Injektionskanüle
 Lens Loop and Lens Nucleus Loop with Irrigation, Injection Cannula
 Asas para cristalino y Cánula para núcleo con irrigación, Cánula para inyección
 Anses à cristallin et Canula du noyau avec irrigation, Canule à injection
 Anse per cristallino con irrigazione, Irrigatore per lenti intraoculari, Cannula per lavaggio

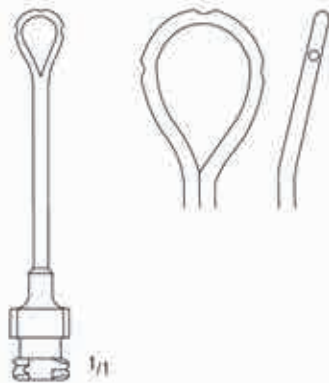

KNOLLE-PEARCE
 KP 755/23
 5,0 cm/2"
 23G

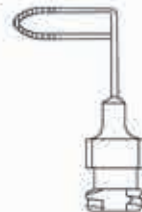
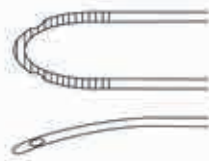

KP 756/01
 25G



SIMCOE
 3,0 cm/1 1/4"
 KP 756/02
 25G



KP 760/21
 4,5 cm/2"
 21G

AA
 AB
 AC
 AD
 AE
 AK
 AR
 KA
 KM
 KO
 KP
 XR

Kapselpolierer, Kapselpeile, Kapselsauger
 Capsule Polisher, Capsule Scraper, Erisiphake
 Pulidor para cápsula, Erisiphake
 Canule gratteuse, Erisiphaque capsulaire
 Levigatore corneale, Aspiratore capsulare



KP 763/01
23G

GRAETHER
4,0 cm/1 1/2"

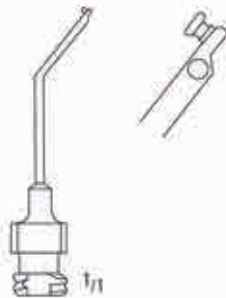

KP 763/02
23G

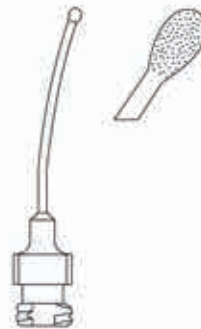

JENSEN
KP 767/27
4,5 cm/2"
27G



KNOLLE
3,5 cm/1 1/2"
KP 768/23 23G
KP 768/30 30G



KRATZ
3,5 cm/1 1/2"
KP 772/01 23G L = 1 mm
KP 772/02 23G L = 2 mm

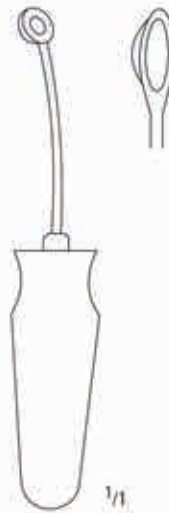

BELL
KP 775/00
6,5 cm/2 1/2"



BELL
KP 775/01

Zyklodialysen-, Alpha-Chymotrypsin- und Zystotomkanüle
 Cyclodialysis-, Alpha-Chymotrypsin- and Cystotome Cannula
 Cânula para ciclodialisis, Alpha-Chymotrypsin y cistótomo
 Canule pour cyclodialyse, à injection Alpha-Chimo-Trypsine et cystotome
 Cannule per ciclodialisi, per alfa-chimotripsina e per cistotomi

AA

AB

AC

AD

AE

AK

AR

KA

KM

KO

KP

XR



KELMAN
4,0 cm//1 1/2"

KP 780/01
19G

KP 780/02
19G

rechts
right
derecho
droit
destro

links
left
izquierda
gauche
sinistro

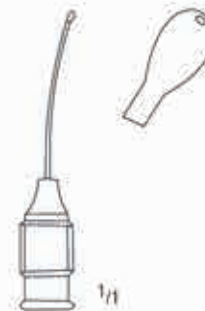

TROUTMAN
KP 783/25
4,5 cm//2"
25G

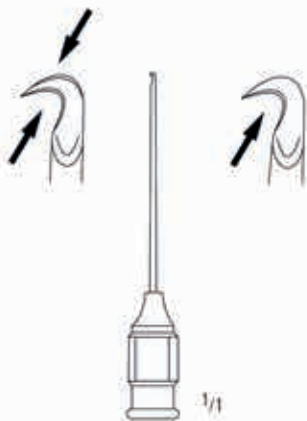

KELMAN
4,5 cm//2"

KP 786/00
22G

KP 786/01
22G

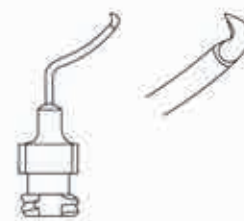

KRATZ
KP 788/22
3,0 cm//1 1/4"
22G

Augennadeln
 Eye Needles
 Agujas oculares
 Aiguilles ophtalmiques
 Aghi oftalmichi

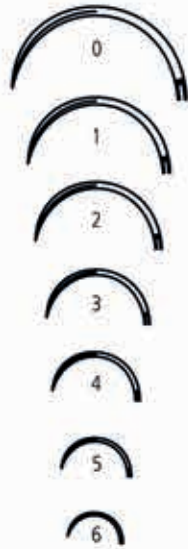

OG
 gebogen 1/2 Kreis
 curved 1/2 circle
 curvas 1/2 círculo
 coubes 1/2 cercle
 curvi 1/2 círculo



OB
 gebogen 3/8 Kreis
 curved 3/8 circle
 curvas 3/8 círculo
 coubes 3/8 cercle
 curvi 3/8 círculo



gewöhnliches Ohr
 regular eye
 ojo ordinario
 chas régulier
 cruna ordinaria

Federöhr
 spring eye
 ojo de resorte
 chas à ressort
 cruna a molla

- KP 950/00
- KP 950/01
- KP 950/02
- KP 950/03
- KP 950/04
- KP 950/05
- KP 950/06

- KP 951/00
- KP 951/01
- KP 951/02
- KP 951/03
- KP 951/04
- KP 951/05
- KP 951/06

- FIG. 0**
- FIG. 1**
- FIG. 2**
- FIG. 3**
- FIG. 4**
- FIG. 5**
- FIG. 6**



gewöhnliches Ohr
 regular eye
 ojo ordinario
 chas régulier
 cruna ordinaria

Federöhr
 spring eye
 ojo de resorte
 chas à ressort
 cruna a molla

- KP 952/00
- KP 952/01
- KP 952/02
- KP 952/03
- KP 952/04
- KP 952/05
- KP 952/06

- KP 953/00
- KP 953/01
- KP 953/02
- KP 953/03
- KP 953/04
- KP 953/05
- KP 953/06

Verkaufseinheit 1 Dutzend
 unit for sale 1 dozen
 unidad de venta 1 docena
 unité d' 1 douzaine
 unità di vendita 1 dozzina

Augenklappen, Pinsel
 Eye Patches, Brushes
 Protectores de ojos, Pincel
 Bandeaux pour les yeux, Pinceau
 Benda di protezione per gli occhi, Pennello



KP 955/01



KP 955/02



KP 956/00



BARRAQUER
 KP 959/00

AA

AB

AC

AD

AE

AK

AR

KA

KM

KD

KP

XR

HF-ZUBEHÖR
HF-ACCESSORIES
AF-ACCESORIOS
HF-ACCESSOIRES
AF-ACCESSORI

XR

nopa[®] instruments



Anschlußkabel, Bi-Koagulations-Pinzetten
 Connection Cords, Bi-Coagulation-Forceps
 Cables de conexión, Pinzas para Coagulación
 Câbles de raccordement, Pincés pour Bi-Coagulation
 Cavi da connessione, Pinze per la Bi-Coagulazione

AA
AB
AC
AD
AE
AK
AR
KA
KM
KD
XP
XR

bipolar



MARTIN / BERCHTHOLD

300 cm XR 830/03
 500 cm XR 830/05

bipolar



ERBE/SELECT

XR 832/03
 XR 832/05

D=0,5 mm

E=Nadel



11,0 cm/4 1/3"	XR 898/11 D	XR 899/11 D
11,0 cm/4 1/3"	XR 898/11 E	XR 899/11 E

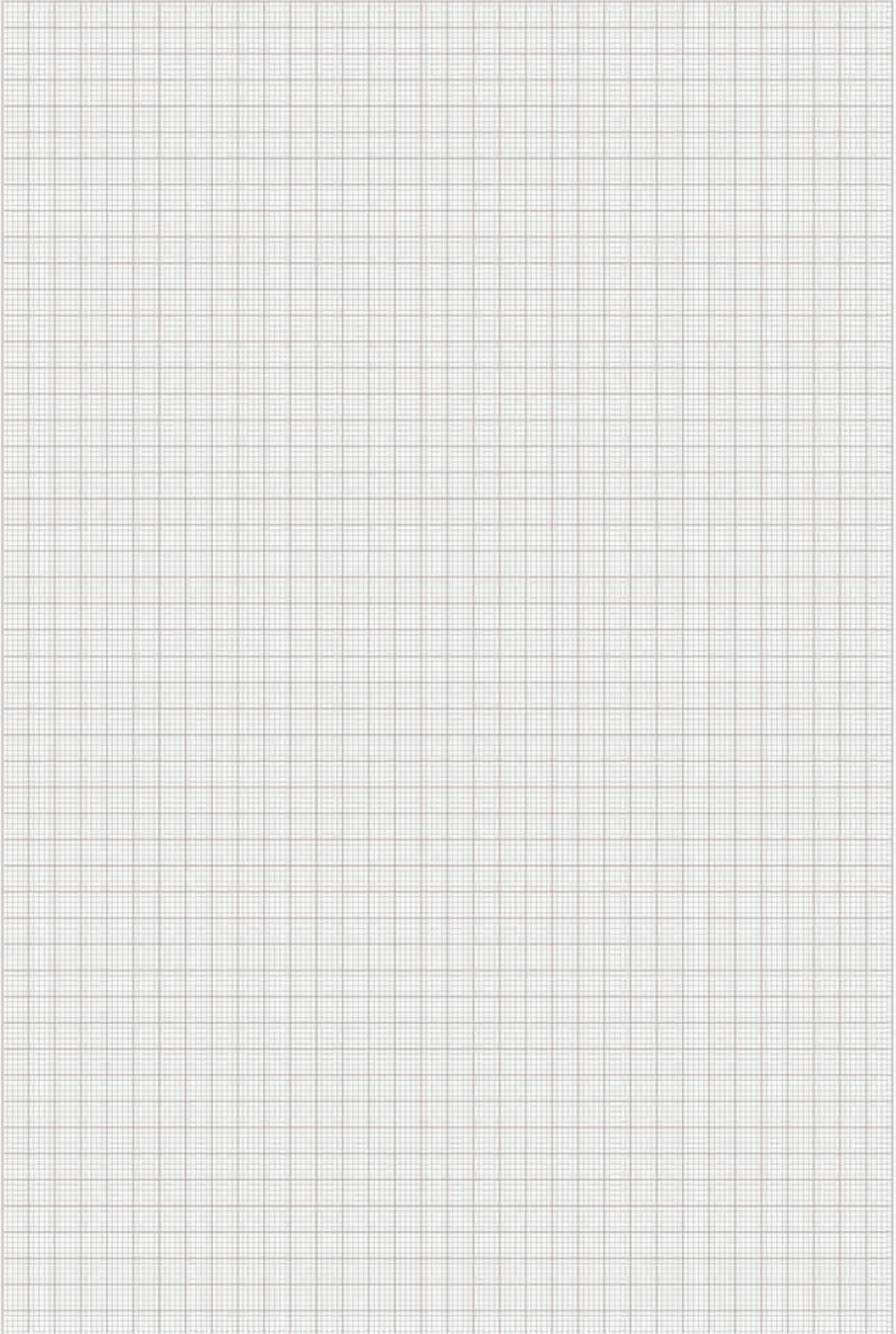

Inhaltsverzeichnis

	Seite		Seite
A			
ADSON , Anatomische Pinzetten	82	BOWMAN , Lidsperrerr	166
ADSON , Chirurgische Pinzetten	82	BOWMAN , Tränenwegsonden	163
ADSON, MICRO Anatomische Pinzetten	82	BROWN-ADSON , Chirurgische Pinzetten	82
ADSON, MICRO Chirurgische Pinzetten	82	Bulldogklemmen	77
ADSON-BROWN , Chirurgische Pinzetten	82	BUNGE , Exenterationslöffel	184
ADVENTITIA , Mikroscheren	114, 116	BUNNKATU , Linsenkernteiler und -trenner	159
AGRICOLA , Tränensackspreizer	170	BURCH , Fixiergabel	155
Alpha-Chymotrypsin-Kanüle	203	BURCH-LESTER , Lidsperrerr	168
Anatomische Pinzetten	82	C	
ANEL , Tränenwegkanülen	200	CASTROVIEJO , Fixierpinzetten	90
ANIS , Nahtplatzierungsmarkeur	192	CASTROVIEJO , Hornhautscheren	109, 110
ANIS , Radialmarkeur	190	CASTROVIEJO , Iridektomiescheren	107
Anlegezangen	77	CASTROVIEJO , Kapselpinzetten	88
Anschlußkabel	209	CASTROVIEJO , Keratoplastiktrepän	195
ARLT , Starschlingen	186	CASTROVIEJO , Lidsperrerr	167
ARLT-FISCHER , Irispinzetten	85	CASTROVIEJO , Löffel für Hornhauttransfer	185
ARRUGA , Kapselpinzetten	89	CASTROVIEJO , Messzirkel	143
ARRUGA , Mikro-Nadelhalter	132	CASTROVIEJO , Mikro-Nadelhalter	131
ARRUGA , Wundlöffel	171	CASTROVIEJO , Mikro-Nadelhalter mit Hartmetalleinsätzen	127, 128
ARRUGA-KALT , Mikro-Nadelhalter	132	CASTROVIEJO , Mikro-Nadelhalter mit Rundgriff	133
Arterienklemmen	78	CASTROVIEJO , Nahtpinzetten	91
Augenklappen	205	CASTROVIEJO , Tränenkanaldilatatoren	165
Augenmagnet mit Fremdkörperschlinge	178	CASTROVIEJO , Zyklodialysenspatel	188
Augennadeln	204	CASTROVIEJO-BARRAQUER , Zyklodialysenspatel	188
Augenscheren	46	CASTROVIEJO-KALT , Mikro-Nadelhalter	132
Axial- und Radialmarkierinstrumente	190	CHADWICK , Augenscheren	104
AYER , Chalazionpinzetten	95	Chalazionlöffel	185, 186
B			
BACKHAUS , Tuchklemmen	79	Chalazionpinzetten	95, 96
BARKAN , Goniotomiemesser	174	Chirurgische Pinzetten	82
BARRAQUER PHAKO , Lidsperrerr	166	CHRIS-TROUTMAN , Klingensbrecher	124
BARRAQUER , Cilienpinzetten	83	Cilienpinzetten	83
BARRAQUER , Lidsperrerr	166	CITELLI , Stanzen	154
BARRAQUER , Mikro-Nadelhalter mit Rundgriff	129	CLAYMAN , Linsenkernewender	158
BARRAQUER , Minischeren	107	CLUB-GOLF , Fremdkörpermeißel	177
BARRAQUER , Vorderkammer-Pinzetten	91	COLIBRI-BARRAQUER , Lidsperrerr	166
BARRAQUER-CASTROVIEJO , Zyklodialysenspatel	188	COLLIN , Skalpelligriffe	121
BARRAQUER-COLIBRI , Lidsperrerr	166	COOK , Lidsperrerr	168
BARRAQUER-FINO , Zyklodialysenspatel	188	CORCELLE , Lidsperrerr	166
BARRAQUER-KATZIN (COLIBRI) , Irispinzetten	87, 88	CULLER , Irisspatel	189
BARRAQUER-KATZIN , Hornhautscheren	111	CUSHING , feine Wundhaken	149
BARRAQUER-KRATZ , Lidsperrerr	166	D	
BARRAQUER-TROUTMAN , Mikro-Nadelhalter mit Rundgriff	129	DAVIEL , Starlöffel	186
BECHERT , Linsenkernewender	158	DAVIS , Fremdkörpermeißel	177
BECHERT-JAFFE , Linsenkernewender	158	DEITZ , Tiefenlehre	194
BEER , Cilienpinzetten	83	Depressor, Sklera-	172
BELL , Kapselsauger	202	DERF , Nadelhalter	126
BERENS , Muskelklemmen	95	DERF , TUC Nadelhalter	126
BERKE , Ptosispinzetten	96	DESMARRES , Chalazionpinzetten	95
Bi-Koagulations Pinzetten	209	DESMARRES , feine Wundhaken	155
BINKHORST , Kapselpinzetten	89	Diamantmesser	180-181
BISHOP-HARMON , Irispinzetten	87	DIEFFENBACH , Bulldogklemmen	77
BISHOP-HARMON , Vorderkammerspülkanülen	198	DIETHRICH , Mikro-Nadelhalter mit Hartmetalleinsätzen	128
BLASCOVICS , Muskelpinzetten	94	Dilatatoren, Tränenkanal-	164, 165
BÖHLER , Hohlmeißelzangen	151	DISSECTION , Mikroscheren	114, 116
BONACCOLTO , Strabismuspinzetten	92	Diszisionsmesser	173
BONN MOD. , Nahtpinzetten	92	DIX , Fremdkörperinstrumente	178
BONN , feine Scheren	101	DORTMUND , Phakospatel	187
BONN , Fixationsring	194	DOUGLAS , Cilienpinzetten	83
BONN , Irishäkchen	156	DRYSDALE , Linsenkeromanipulatoren	159
BONN , Irispinzetten	86, 87	E	
BONN , Skleramesser	174	ELLIOT , Skleratrepän	196
BONN , Spülkanülen	198	ELLIOT , Trepänhandgriff	196
BORES , Axialmarkeur	190	ELLIS , Fremdkörpermeißel	177
		ELSCHNIG , Fixierpinzetten	90
		Entropiumpinzetten	95

	Seite		Seite
Enukleationslöffel	184	Hammer	151
ERHARDT , Entropiumpinzetten	95	HARMON-BISHOP , Irispinzetten	87
Exenterationslöffel	184	HARMON-BISHOP , Vorderkammerspülkanülen	198
F		HARMS , Knüpfpinzetten mit Plateau	93
Fadenpinzetten	92, 93	HARMS , Trabekularsonden	165
Fasszangen, Vitrektomie-	183	HARTMANN , Arterienklemmen	78
FAULKNER , Linsenhaltepinzetten	97	HARTMANN-HALLE , Nasenspekula	155
Feine Scheren	101	HEBRA , Chalazionslöffel	186
Feine Wundhaken	147-150	HESS , Irispinzetten	86
FINO-BARRAQUER , Zyklodialysenspatel	188	HESS-GILL , Irispinzetten	88
FISCHER-ARLT , Irispinzetten	85	HIRSCHMANN , IOL Positionsspatel	187
Fixiergabel	155	HIRSCHMANN , Irishäkchen	157
Fixierkrallen	155	HOFFER , Markeur optisches Zentrum	190
Fixierpinzetten	89, 90	Hohlmeißel	155
Fixierringe	194, 195	Hohlmeißelzangen	151
FLIERINGA , Fixierringe	195	HOPKINS-JOHNS , Anlegezangen	77
FOERSTER , Irispinzetten	86	HOPKINS-JOHNS , Bulldogklemmen	77
FRANCESCHETTI , Keratoplastiktrepán	195	Hornhautfräsen	196
FRANCIS , Fremdkörpermeißel	177	Hornhautmarkierinstrumente	191
Fräsen, Hornhaut-	196	Hornhautmesser	173
Fräsen, Rostring	195	Hornhautschaber	173
FRAZIER , feine Wundhaken	147	Hornhautscheren	87-90
Fremdkörperinstrumente	178	Hornhauttrephinen	195, 196
Fremdkörpermeißel	176-178	I	
Fremdkörpernadeln	176-178	Injektionskanülen	201
FRENCH-EYE/Ryder , TUC Nadelhalter	126	Inzisionsmarkierinstrumente	192
FRIEDBURG , Spül-Saugkanülen	199	IOL Manipulator und Irisretraktor	161
FRIEDMAN , Hohlmeißelzangen	151	IOL Positionshäkchen	160, 161
FUCHS-GILL , Irispinzetten	88	Iridektomiescheren	102, 106, 107
G		Irishäkchen	156, 157
GASS , Netzhautablösungshaken	154	Irispinzetten	84-88
GASS , Sklera Marker	172	Irisretraktor und IOL Manipulator	161
GILL , Hornhautmesser	173	Irisscheren	102, 103
GILL , Irispinzetten	88	Irisspatel	189
GILL-FUCHS , Irispinzetten	88	J	
GILL-HESS , Irispinzetten	88	JACOBSON , Mikro-Nadelhalter	131
GILLIES , feine Wundhaken	147	JACOBSON , Mikro-Nadelhalter mit Hartmetalleinsätzen	128
GILLS-WELSH , Kapsulotomiescheren	109	JAEGER , Lidplatte	170
GILLS-WELSH , Kortex-Extraktoren	200	JAFFE , Lidhalter	170
Glattstreicher für Lamellarklappe	171	JAFFE , Positionsspatel	187
GOLF-CLUB , Fremdkörpermeißel	177	JAFFE-BECHERT , Linsenkernwender	158
Goniotomiemesser	174	JAFFE-KNOLLE , Irishäkchen	156
GONNIN , Amsler Markeur	192	JAFFE-MALTZMANN , IOL Positionshäkchen	161
GRADLE , Cilienpinzetten	83	JAMESON , Muskelhaken	154
GRAEFE , Augenscheren	103	JAMESON , Muskelpinzetten	94
GRAEFE , feine Wundhaken	154	JAMESON , Schieblehre	143
GRAEFE , Fixierpinzetten	89	JAPAN-TOHOKU , Tuchklemmen	80
GRAEFE , Irispinzetten	84	JENSEN , Kapselpolierer	202
GRAEFE , Schielhaken	154	JOHNS-HOPKINS , Anlegezangen	77
GRAEFE , Starlöffel	186	JOHNS-HOPKINS , Bulldogklemmen	77
GRAEFE , Starmesser	174	JONES , Tuchklemmen	79
GRAEFE , Zystotome	175	K	
GRAETHER , Kragenknoepfkanülen	202	KALT , Mikro-Nadelhalter	132
GRANDON , T-Inzision's Markeur	190	KALT , Mikro-Nadelhalter mit Hartmetalleinsätzen	128
GREEN , Fixierpinzetten	89	KALT-ARRUGA , Mikro-Nadelhalter	132
GREEN , Muskelhaken	154	KALT-CASTROVIEJO , Mikro-Nadelhalter	132
Griffe, Skalpell-	121, 122	Kanüle, Alpha-Chymotrypsin-	203
GUTHRIE , feine Wundhaken	155	Kanülen, Injektions-	201
H		Kanülen, Spül-	198
Häkchen, Iris-	156, 157	Kanülen, Vorderkammer-	199
Haken, Muskel-	154	Kanülen, Zyklodialysen-	203
Haken, Netzhautablösungs-	154	Kanülen, Zystotom-	203
Haken, Phako-	159	Kapselneifen	202
Haken, Schiel-	154	Kapselpinzetten	88, 89
HALLE-HARTMANN , Nasenspekula	155	Kapselpolierer	202
HALSEY , Nadelhalter	126	Kapselsauger	202
HALSEY , TUC Nadelhalter	126	Kapsulorhexispinzetten	97
HALSTED-MOSQUITO , Arterienklemmen	78	Kapsulotomiescheren	109
HAMBURG , Luftlanzen	175	KATZIN , Hornhautscheren	110

	Seite		Seite
KATZIN-BARRAQUER (COLIBRI) , Irispinzetten	87, 88	Manipulatoren, Linsenkern-	158, 159
KATZIN-BARRAQUER , Hornhautscheren	111	Marker, Sklera-	172
Keilbeinstanzen	155	Markeure, div.	190-192
KELMAN , Zyklodialysenkanülen	203	Markierinstrumente optisches Zentrum	190
KELMAN , Zystotomkanülen	203	MARTIN , Keratoplastiktrepán	195
KELMAN-McPHERSON , Nahtpinzetten	92	Maßstab	143
Keratometer	193	MAUMENEE-PARK , Lidsperrer	167
Keratoplastikmesser	175	Mc DONALD , Kapsulorhexispinzetten	97
KERRISON , Keilbeinstanzen	155	Mc INTYRE , Spülkanülen	198
KILNER , feine Wundhaken	147	Mc INTYRE , Vorderkammerkanülen	199
KIRBY , Irispinzetten	87	Mc PERSON , Knüpfpinzetten	91
KLEINERT-KUTZ , feine Wundhaken	147	Mc PERSON-KELMAN , Nahtpinzetten	92
Klemmen, Arterien-	78	Meißel	151
Klemmen, Bulldog-	77	Meißel, Fremdkörper-	176-178
Klemmen, Tuch-	79, 80	MENDEZ , Grad Messinstrument	194
Klingenbrecher	124	Messer, Diamant-	180-181
KNAPP , feine Wundhaken	155	Messer, Diszisions-	173
KNAPP , Löffel für Hornhauttransfer	185	Messer, Goniotomie-	174
KNOLLE , Hinterkapselpolierer	202	Messer, Hornhaut-	173
KNOLLE , Irishäkchen	156	Messer, Keratoplastik-	175
KNOLLE , Linsenkernspatel	187	Messer, Sklera-	174
KNOLLE-JAFFE , Irishäkchen	156	Messer, Star-	174
KNOLLE-PEARCE , Linsenschlingen	201	Messinstrumente	143, 194
Knüpfpinzetten mit Plateau	93	Messzirkel	143
Kortex-Extraktoren	200	MEYHOEFER , Chalazionslöffel	185
KRATZ , Kapsel feile	202	MICRO-ADSON , Anatomische Pinzetten	82
KRATZ , Zystotomkanülen	203	MICRO-ADSON , Chirurgische Pinzetten	82
KRATZ-BARRAQUER , Lidsperrer	166	Mikro-Nadelhalter	128-133
KUHNT , Hornhautschaber	173	Mikro-Nadelhalter	128-133
KUTZ-KLEINERT , feine Wundhaken	147	Mikro-Nadelhalter mit Hartmetalleinsätzen	127, 128
L		Mikro-Nadelhalter mit Rundgriff	128, 129, 130, 133
LA GRANGE , Augenscheren	104	Mikroscheren	112-118
LAMPERT , Chalazionpinzetten	96	Mikroscheren, Adventitia	114, 116
LANCASTER , Lidsperrer	168	Mikroscheren, Dissection	114, 116
LASIK , Glattstreicher für Lamellarklappe	171	Mikroscheren, Nerve	116
LESTER , Fixierpinzetten	90	Minischeren	107
LESTER , IOL Positionshäkchen	161	MOD. BONN , feine Scheren	101
LESTER-BURCH , Lidsperrer	168	MOD. BONN , Irispinzetten	86, 87
LEWICKY , IOL Positionshäkchen	160	MOD. BONN , Nahtpinzetten	92
LEWIS , Starschlingen	186	MOD. BONN , Spülkanülen	198
Lidhalter	170	MOD. DORTMUND , Phakospatel	187
Lidplatte	170	MOD. HAMBURG , Luftlanzen	175
Lidsperrer	166-169	MOD. TÜBINGEN , Fadenpinzetten	92
LIEBERMAN , Lidsperrer	169	MOD. TÜBINGEN-VANNAS , Nachstarscheren	108
Ligaturscheren	106	MOLDESTAD , feine Wundhaken	149
Limbusmarkierinstrumente	192	MOORFIELD , Nahtpinzetten	90
LINDSTROM , Hornhautmarkeur	191	MOSQUITO-HALSTED , Arterienklemmen	78
Linsenhaltepinzetten	97	MULDOON , Tränenkanaldilatatoren	164
Linsenkernmanipulatoren	158, 159	Muskelhaken	154
Linsenkernschlingen	201	Muskelpinzetten	94, 95
Linsenkernspatel	187	N	
Linsenkernwender	158	Nachstarscheren	108, 109
Linsenschlingen	201	Nadelhalter, Mikro-	128-133
LIPPMAN , Linsenkernspatel	187	Nadelhalter, Mikro mit Hartmetalleinsätzen	127, 128
LITTAUER , Cilienpinzetten	83	Nadeln, Augen-	204
Löffel für Hornhauttransfer	185	Nadeln, Fremdkörper-	176-178
Löffel, Chalazion-	185, 186	NAGAHARA , Phako Chopper Klingen	159
Löffel, E nukleations-	184	Nahtpinzetten	90-93
Löffel, Exenterations-	184	Nahtplatzierungsmarkierinstrumente	192
Löffel, Star-	185, 186	Nasenspekula	155
LORNA , Tuchklemmen	80	NERVE , Mikroscheren	116
LU , Hornhautmarkeur Lasik	191	Netzhautablösungshaken	154
LUER , Hohlmeißelzangen	151	NEW ORLEANS , Starschlingen	186
LUER-LOCK , Verbindung	198	NOYES , Iridektomiescheren	106
Luftkanülen	199	NOYES , Mikroscheren	112
Luftlanzen	175	O	
M		OB , Augennadeln	204
MALONEY , Intra-operativer Keratometer	193	OBSTBAUM , Positionsspatel	187
MALTSMANN-JAFFE , IOL Positionshäkchen	161	O' CONNOR , feine Wundhaken	154

	Seite		Seite
OG , Augennadeln	204	Scheren, Mikro-	112-118
Ophthalmoskop	144	Scheren, Mini-	107
Orbitalretraktoren	171	Scheren, Nachstar-	108, 109
Orbitalspatel	171	Scheren, Sehnen-	104, 109
OSHER , Linsenkernmanipulatoren	158	Scheren, Strabismus-	103, 112
P		Scheren, Vitrektomie-	182
PARK-MAUMENEE , Lidsperrer	167	Schieblehre	143
PARTSCH , Hammer	151	Schielhaken	154
PARTSCH , Meißel	151	SCHIOETZ , Tonometer	193
PATON , Mikro-Nadelhalter	132	Schlingen, Linsen-	201
PAUFIQUE , Fadenpinzetten	93	Schlingen, Linsenkern-	201
PAUFIQUE , Keratoplastikmesser	175	SCHOCKET , Sklera Depressoren	172
PEARCE-KNOLLE , Linsenschlingen	201	SCHOTT , Lidsperrer	167
PEERS , Tuchklemmen	80	Sehnenhäkchen	155
PHAKO BARRAQUER , Lidsperrer	166	Sehnscheren	104, 109
Phakohaken	159	Sets	55-64
Pinsel	205	SIMCOE , Kortex-Extraktoren	200
Pinzetten, Bi Koagulations-	209	SIMCOE , Linsenkernschlingen	201
Pinzetten, Chalazion-	95, 96	SIMCOE , Spül-Saugkanülen	199
Pinzetten, Cilien-	83	SINSKEY, IOL Positionshäkchen	160
Pinzetten, Entropium-	95	Skalpellgriffe	121, 122
Pinzetten, Faden-	92, 93	Skalpellklingen	122, 123
Pinzetten, Fixier-	89, 90	Skleradepressoren	172
Pinzetten, Iris-	84-88	Skleramarker	172
Pinzetten, Kapsel-	88, 89	Skleramesser	174
Pinzetten, Kapsulorhexis-	97	SMITH-POTTS , Mikro-Nadelhalter	132
Pinzetten, Knüpf-	93	SMITH-POTTS , Mikro-Nadelhalter mit Hartmetalleinsätzen	128
Pinzetten, Linsenhalte-	97	SNELLEN , Entropiumpinzetten	95
Pinzetten, Muskel-	94, 95	SNELLEN , Starschlingen	186
Pinzetten, Naht-	90-93	Sonden, Pigtail-	165
Pinzetten, Ptosis-	96	Sonden, Trabekular-	165
Pinzetten, Strabismus-	92	Spatel, Iris-	189
Pinzetten, Vorderkammer-	91	Spatel, Linsenkern-	187
PLEY , Lidsperrer	168	Spatel, Phako-	187
Positionshäkchen, IOL	160, 161	Spatel, Positions-	187
Positionsspatel	187	Spatel, Zyklodialysen-	188
POTTS-SMITH , Mikro-Nadelhalter	132	SPENCER , Ligaturscheren	106
POTTS-SMITH , Mikro-Nadelhalter mit Hartmetalleinsätzen	128	Sperrer, Lid-	166-169
PRINCE , Muskelpinzetten	94	Spreizer, Tränensack-	170
Ptosispinzetten	96	Spülkanülen	198
R		ST. MARTIN , Nahtpinzetten	91
Radial- und Axialmarkierinstrumente	190	Stanzen	154
Rasierklingen	124	Starlöffel	185, 186
REILL , Mikro-Nadelhalter mit Rundgriff	130	Starmesser	174
RENTSCH , Irisretraktor und IOL Manipulator	161	Starschlingen	186
RIBBON , Augenscheren	105	STEVENS , Irispinzetten	85
ROEDER , Tuchklemmen	79	STEVENS , Mikro-Nadelhalter	132
ROLLET , feine Wundhaken	155	STEVENS , Sehnenhäkchen	155
ROSEN , Phako-Splitterhäkchen	159	STEVENS , Sehnscheren	104
Rostringfräsen	195	STEVENSON , Tränensackspreizer	170
RUEDEMANN , Tränenkanaldilatatoren	164	STILLE , Fremdkörperinstrumente	178
RYDER/FRENCH-EYE , TUC Nadelhalter	126	STORZ , Hornhautfräsen	196
S		Strabismuspinzetten	92
SATO , Hornhautmesser	173	Strabismusscheren	103, 112
SATTLER , Muskelpinzetten	94	T	
SAUER , Lidsperrer	168	TERSON , Kapselpinzetten	88
SAUTTER , Luftkanülen	199	THORNTON , Doppel-Hornhautmarkeur	192
SAUTTER , Orbitalspatel	171	THORNTON , Fixationsring	194
Schaber, Hornhaut-	173	THORNTON , Limbus Inzisionsmarkeur	192
SCHAEDEL , Tuchklemmen	79	Tiefenlehre	194
SCHEPENS , Orbitalretraktor	171	TOHOKU-JAPAN , Tuchklemmen	80
SCHEPENS , Sklera Depressoren	172	Tonometer	193
Scheren, Augen-	101-105	TOOK , Hornhautmesser	173
Scheren, fein	101	Trabekularsonden	165
Scheren, Hornhaut-	87-90	Tränenkanaldilatatoren	164, 165
Scheren, Iridektomie-	102, 106, 107	Tränenkanalsonden	163
Scheren, Iris-	102, 103	Tränensackspreizer	170
Scheren, Kapsulotomie-	109	Tränenwegkanülen	200
Scheren, Ligatur-	106	TROUTMAN (CORNEAL) , Irispinzetten	88

TROUTMAN , Alpha-Chymotrypsin-Kanülen	203
TROUTMAN , Hornhautscheren	110
TROUTMAN , Mikro-Nadelhalter mit Rundgriff	130
TROUTMAN-BARRAQUER , Mikro-Nadelhalter mit Rundgriff	129
TROUTMAN-CHRIS , Klingenbrecher	124
TÜBINGEN MOD. , Fadenpinzetten	92
Tuchklemmen	79, 80
TYRELL , Irishäkchen	157
V	
VANNAS MOD. TÜBINGEN , Nachstarscheren	108
VANNAS , Nachstarscheren	108
Vitrektomiefasszangen	183
Vitrektomieinstrumente	182, 183
Vitrektomiescheren	182
Vorderkammerkanülen	199
Vorderkammerpinzetten	91
Vorderkammerspülkanülen	198
W	
WECKER , Iridektomiescheren	106
WECKER , Irisspatel	189
WELLS , E nukleationslöffel	184
WELSH , Kortex-Extraktor	200
WELSH-GILLS , Kapsulotomiescheren	109
WELSH-GILLS , Kortex-Extraktor	200
Wender, Linsenkern-	158
WEST , Hohlmeißel	155
WESTCOTT , Sehnenscheren	109
WESTCOTT , Strabismusscheren	112
WHEELER , Diszisionsmesser	173
WILDER , Tränenkanaldilatatore	164
WILLIAMS , Lidsperrer	166
WILMER , Augenscheren	103
WORST , Pigtail Sonden	165
Wundhaken, fein	147-150
Wundlöffel	171
Z	
Zangen, Hohlmeißel-	151
ZIEGLER , Cilienpinzetten	83
ZIEGLER , Diszisionsmesser	173
Zyklodialysenkanülen	203
Zyklodialysenspatel	188
Zystotome	175
Zystotomkanülen	203

Index

	Page		Page
A			
ADSON , Dressing Forceps	82	BONN , Tying Forceps with platform	92
ADSON, MICRO Dressing Forceps	82	BORES , Axis Markers	190
ADSON, MICRO Tissue Forceps	82	BOWMAN , Eye Specula	166
ADSON , Tissue Forceps	82	BOWMAN , Lacrimal Probes	163
ADSON-BROWN , Tissue Forceps	82	BROWN-ADSON , Tissue Forceps	82
ADVENTITIA , Micro Scissors	114, 116	Brushes	205
AGRICOLA , Lacrimal Sac Retractors	170	Bulldog Clamps	77
Air Injection Cannulas	199	BUNGE , Exenteration Spoons	184
Alpha-Chymotrypsin Cannulas	203	BUNNKATU , Nucleus Dividing and Separating Hook	159
Amsler Markers	192	BURCH , Fixation Forks	155
ANEL , Lacrimal Cannulas	200	BURCH-LESTER , Eye Specula	168
ANIS , Radial Markers	190	Burrs, Corneal	196
ANIS , Suture Placement Markers	192	C	
Anterior Chamber Cannulas	199	Caliper	143
Anterior Chamber Forceps	91	Cannulas, Air Injection	199
Anterior Chamber Irrigation Cannulas	198	Cannulas, Alpha-Chymotrypsin	203
ARLT , Lens Scoops	186	Cannulas, Anterior Chamber	199
ARLT-FISCHER , Iris Forceps	85	Cannulas, Anterior Chamber Irrigation	198
ARRUGA , Capsular Forceps	89	Cannulas, Cyclodialysis	203
ARRUGA , Micro Needle Holders	132	Cannulas, Cystotome	203
ARRUGA , Protectors	171	Cannulas, Injection	201
ARRUGA-KALT , Micro Needle Holders	132	Cannulas, Irrigation	198
Artery Forceps	78	Cannulas, Lacrimal	200
Axis Markers	190	Capsular Forceps	88, 89
AYER , Chalazion Forceps	95	Capsule Polishers	202
B			
BACKHAUS , Towel Forceps	79	Capsule Scrapers	202
BARKAN , Goniotomy Knives	174	Capsulorhexis Forceps	97
BARRAQUER PHAKO , Eye Specula	166	Capsulotomy Scissors	109
BARRAQUER , Anterior Chamber Forceps	91	CASTROVIEJO , Caliper	143
BARRAQUER , Cilia Forceps	83	CASTROVIEJO , Capsular Forceps	88
BARRAQUER , Eye Specula	166	CASTROVIEJO , Corneal Button Transfer Spoons	185
BARRAQUER , Micro Needle Holders with pen-type handle	129	CASTROVIEJO , Corneal Scissors	109, 110
BARRAQUER , Mini Scissors	107	CASTROVIEJO , Cyclodialysis Spatulas	188
BARRAQUER-CASTROVIEJO , Cyclodialysis Spatulas	188	CASTROVIEJO , Eye Specula	167
BARRAQUER-COLIBRI , Eye Specula	166	CASTROVIEJO , Fixation Forceps	90
BARRAQUER-FINO , Cyclodialysis Spatulas	188	CASTROVIEJO , Iris Scissors	107
BARRAQUER-KATZIN (COLIBRI) , Iris Forceps	87, 88	CASTROVIEJO , Keratoplasty Trephines	195
BARRAQUER-KATZIN , Corneal Scissors	111	CASTROVIEJO , Lacrimal Dilators	165
BARRAQUER-KRATZ , Eye Specula	166	CASTROVIEJO , Micro Needle Holders	131
BARRAQUER-TROUTMAN , Micro Needle Holders w. pen-type handle	129	CASTROVIEJO , Micro Needle Holders with pen-type handle	133
BECHERT , Lens Nucleus Rotators	158	CASTROVIEJO , Micro Needle Holders w. Tung. Carbide Inserts	127, 128
BECHERT-JAFFE , Lens Nucleus Rotators	158	CASTROVIEJO , Suture Forceps	91
BEER , Cilia Forceps	83	CASTROVIEJO-BARRAQUER , Cyclodialysis Spatulas	188
BELL , Erisiphake	202	CASTROVIEJO-KALT , Micro Needle Holders	132
BERENS , Muscular Forceps	95	Cataract Knives	174
BERKE , Ptosis Forceps	96	Cataract Spoons	185, 186
Bi-Coagulation-Forceps	209	CHADWICK , Eye Scissors	104
BINKHORST , Capsular Forceps	89	Chalazion Curettes	185, 186
BISHOP-HARMON , Anterior Chamber Irrigation Cannulas	198	Chalazion Forceps	95, 96
BISHOP-HARMON , Iris Forceps	87	Chisels	151
Blade Breakers	124	CHRIS-TROUTMAN , Blade Breakers	124
Blade, Phaco Chopper	159	Cilia Forceps	83
BLASCOVICS , Muscular Forceps	94	CITELLI , Punches	154
BÖHLER , Bone Rongeurs	151	Clamps, Bulldog	77
BONACCOLTO , Strabismus Forceps	92	CLAYMAN , Lens Nucleus Rotators	158
Bone Rongeurs	151	CLUB-GOLF , Foreign Body Spuds	177
BONN , Fine Scissors	101	COLIBRI-BARRAQUER , Eye Specula	166
BONN , Fixation Rings	194	COLLIN , Scalpel Handles	121
BONN , Iris Forceps	86, 87	Connection Cords	209
BONN , Iris Hooks	156	Connection, Luer-Lock	198
BONN , Irrigation Cannulas	198	COOK , Eye Specula	168
BONN , Scleral Knives	174	CORCELLE , Eye Specula	166
		Corneal Burrs	196
		Corneal Button Transfer Spoons	185
		Corneal Knives	173

	Page		Page
Corneal Markers	191	Forceps, Cilia	83
Corneal Scarifiers	173	Forceps, Entropium	95
Corneal Scissors	87-90	Forceps, Fixation	89, 90
Corneal Trephines	195, 196	Forceps, Iris	46
Cortex Extractors	200	Forceps, Lens Holding	97
CULLER , Iris Spatulas	189	Forceps, Muscular	94, 95
Curettes, Chalazion	185, 186	Forceps, Setting	77
CUSHING , Delicate Hooks	149	Forceps, Strabismus	92
Cyclodialysis Cannulas	203	Forceps, Suture	46
Cyclodialysis Spatulas	188	Forceps, Towel	79, 80
Cystotome Cannulas	203	Foreign Body Instruments	178
Cystotomes	175	Foreign Body Needles	176-178
D		Foreign Body Spuds	176-178
DAVIEL , Cataract Spoons	186	FRANCESCHETTI , Keratoplasty Trephines	195
DAVIS , Foreign Body Spuds	177	FRANCIS , Foreign Body Spuds	177
DEITZ , Depth Gauges	194	FRAZIER , Delicate Hooks	147
Delicate Hooks	147-150	FRENCH-EYE, RYDER , TUC Needle Holders	126
Depressors, Scleral	172	FRIEDBURG , Suction- and Irrigation Cannulas	199
Depth Gauges	194	FRIEDMAN , Bone Rongeurs	151
DERF , Needle Holders	126	FUCHS-GILL , Capsular Forceps	88
DERF , TUC Needle Holders	126	G	
DESMARRES , Chalazion Forceps	95	GASS , Retinal Detachment Hooks	154
DESMARRES , Delicate Hooks	155	GASS , Scleral Marker	172
Diamond Knives	180-181	Gauges	155
DIEFFENBACH , Bulldog Clamps	77	Gauges, Depth	194
DIETRICH , Micro Needle Holders with Tungsten Carbide Inserts	128	GILL , Capsular Forceps	88
Dilators, Lacrimal	164, 165	GILL , Corneal Knives	173
Discission Knives	173	GILL-FUCHS , Capsular Forceps	88
DISSECTION , Micro Scissors	114, 116	GILL-HESS , Capsular Forceps	88
DIX , Foreign Body Instruments	178	GILLIES , Delicate Hooks	147
DORTMUND , Phako Spatulas	187	GILLS-WELSH , Capsulotomy Scissors	109
Double Corneal Markers	192	GILLS-WELSH , Cortex Extractors	200
DOUGLAS , Cilia Forceps	83	GOLF-CLUB , Foreign Body Spuds	177
Dressing Forceps	82	Goniotomy Knives	174
DRYSDALE , Lens Nucleus Manipulators	159	GONNIN , Amsler Marker	192
E		Gouges, Foreign Body	176, 178
ELLIOT , Handles for Trephines	196	GRADLE , Cilia Forceps	83
ELLIOT , Scleral Trephines	196	GRAEFE , Cataract Knives	174
ELLIS , Foreign Body Spuds	177	GRAEFE , Cataract Spoons	186
ELSCHNIG , Fixation Forceps	90	GRAEFE , Cystotomes	175
Entropium Forceps	95	GRAEFE , Delicate Hooks	154
Enucleation Spoons	184	GRAEFE , Eye Scissors	103
ERHARDT , Entropium Forceps	95	GRAEFE , Fixation Forceps	89
Erisiphake	202	GRAEFE , Iris Forceps	84
Exenteration Spoons	184	GRAEFE , Strabismus Hooks	154
Extractors, Cortex	200	GRAETHER , Collar Button Cannulas	202
Eye Needles	204	GRANDON , T-Incision Markers	190
Eye Patch	205	Grasping Forceps, Vitrectomy	183
Eye Scissors	101-105	GREEN , Fixation Forceps	89
Eye Specula	166-169	GREEN , Muscle Hooks	154
F		GUTHRIE , Delicate Hooks	155
FAULKNER , Lens Holding Forceps	97	H	
Fine Scissors	101	HALLE-HARTMANN , Nasal Specula	155
FINO-BARRAQUER , Cyclodialysis Spatulas	188	HALSEY , Needle Holders	126
FISCHER-ARLT , Iris Forceps	85	HALSEY , TUC Needle Holders	126
Fixation Forceps	89, 90	HALSTED-MOSQUITO , Artery Forceps	78
Fixation Forks	155	HAMBURG , Keratome	175
Fixation Rings	194, 195	Handles for Trephines	196
Flap Smoothers	171	Handles, Scalpel	121, 122
FLIERINGA , Fixation Rings	195	HARMON-BISHOP , Anterior Chamber Irrigation Cannulas	198
FOERSTER , Iris Forceps	86	HARMON-BISHOP , Iris Forceps	87
Forceps Ptosis	96	HARMS , Trabecular Probes	165
Forceps Tying with platform	93	HARMS , Tying Forceps with platform	93
Forceps, Anterior Chamber	91	HARTMANN , Artery Forceps	78
Forceps, Artery	78	HARTMANN-HALLE , Nasal Specula	155
Forceps, Bi-Coagulation	209	HEBRA , Chalazion Curettes	186
Forceps, Capsular	88, 89	HESS , Iris Forceps	86
Forceps, Capsulorhexis	97	HESS-GILL , Capsular Forceps	88
Forceps, Chalazion	95, 96	HIRSCHMANN , IOL Lens Spatulas	187

	Page		Page
HIRSCHMANN , Iris Hooks	157	KNOLLE-JAFFE , Iris Hooks	156
HOFFER , Optical Zone Markers	190	KNOLLE-PEARCE , Irrigating Vectis	201
Hook, Nucleus Dividing and Separating	159	KRATZ , Capsule Scraper	202
Hooks, Delicate	147-150	KRATZ , Cystotome Cannulas	203
Hooks, Iris	156, 157	KRATZ-BARRAQUER , Eye Specula	166
Hooks, Muscle	154	KUHNT , Corneal Scarifiers	173
Hooks, Phaco	159	KUTZ-KLEINERT , Delicate Hooks	147
Hooks, Phaco Splitter	159	L	
Hooks, Retinal Detachment	154	LA GRANGE , Eye Scissors	104
Hooks, Strabismus	154	Lacrimal Cannulas	200
Hooks, Tenotomy	155	Lacrimal Dilators	164, 165
HOPKINS-JOHNS , Bulldog Clamps	77	Lacrimal Probes	163
HOPKINS-JOHNS , Setting Forceps	77	Lacrimal Sac Retractors	170
I		LAMPERT , Chalazion Forceps	96
Injection Cannulas	201	LANCASTER , Eye Specula	168
Iris Forceps	84-88	LASIK , Flap Smoothers	171
Iris Hooks	156, 157	Lens Holding Forceps	97
Iris Scissors	102, 103, 106, 107	Lens Manipulators	158-161
Iris Spatulas	189	Lens Nucleus Manipulators	158, 161
Irrigating Lens Nucleus Loops	201	Lens Nucleus Rotators	158
Irrigating Vectis	201	Lens Nucleus Spatulas	187
Irrigation Cannulas	198	Lens Scoops	186
J		Lens Spatulas	187
JACOBSON , Micro Needle Holders	131	LESTER , Fixation Forceps	90
JACOBSON , Micro Needle Holders with Tungsten Carbide Inserts	128	LESTER , Lens Manipulators	161
JAEGER , Lid Plates	170	LESTER-BURCH , Eye Specula	168
JAFFE , Lens Spatulas	187	LEWICKY , Lens Manipulators	160
JAFFE , Lid Retractors	170	LEWIS , Lens Scoops	186
JAFFE-BECHERT , Lens Nucleus Rotators	158	Lid Plates	170
JAFFE-KNOLLE , Iris Hooks	156	LIEBERMAN , Eye Specula	169
JAFFE-MALTZMANN , Lens Manipulators	161	Ligature Scissors	106
JAMESON , Caliper	143	Limbal Incision Rulers	193
JAMESON , Muscle Hooks	154	LINDSTROM , Corneal Markers	191
JAMESON , Muscular Forceps	94	LIPPMAN , Lens Nucleus Spatulas	187
JAPAN-TOHOKU , Towel Forceps	80	LITTAUER , Cilia Forceps	83
JENSEN , Capsule Polisher	202	Loops, Irrigating Lens Nucleus Loops	201
JOHNS-HOPKINS , Bulldog Clamps	77	LORNA , Towel Forceps	80
JOHNS-HOPKINS , Setting Forceps	77	LU , Corneal Markers Lasik	191
JONES , Towel Forceps	79	LUER , Bone Rongeurs	151
K		LUER-LOCK , Connection	198
KALT , Micro Needle Holders	132	M	
KALT , Micro Needle Holders with Tungsten Carbide Inserts	128	Magnetic Eye Probes with Foreign Body Loop	178
KALT-ARRUGA , Micro Needle Holders	132	Mallet	151
KALT-CASTROVIEJO , Micro Needle Holders	132	MALONEY , Keratometers	193
KATZIN , Corneal Scissors	110	MALTZMANN-JAFFE , Lens Manipulators	161
KATZIN-BARRAQUER (COLIBRI) , Iris Forceps	87, 88	Manipulators, Lens	158-161
KATZIN-BARRAQUER , Corneal Scissors	111	Manipulators, Lens Nucleus	158, 161
KELMAN , Cyclodialysis Cannulas	203	Marker, Scleral	172
KELMAN , Cystotome Cannulas	203	Markers, Amsler	192
KELMAN-McPHERSON , Tying Forceps with platform	92	Markers, Axis	190
Keratome	175	Markers, Corneal	191
Keratometers	193	Markers, Double Corneal	192
Keratoplasty Knives	175	Markers, Optical Zone	190
KERRISON , Sphenoid Punches	155	Markers, Radial	190
KILNER , Delicate Hooks	147	Markers, Suture Placement	192
KIRBY , Iris Forceps	87	Markers, T-Incision	190
KLEINERT-KUTZ , Delicate Hooks	147	MARTIN , Keratoplasty Trephines	195
KNAPP , Corneal Button Transfer Spoons	185	MARTIN, ST. Suture Forceps	91
KNAPP , Delicate Hooks	155	MAUMENEE-PARK , Eye Specula	167
Knives, Cataract	174	Mc DONALD , Capsulorhexis Forceps	97
Knives, Corneal	173	Mc INTYRE , Anterior Chamber Cannulas	199
Knives, Diamond	180-181	Mc INTYRE , Irrigation Cannulas	198
Knives, Discission	173	Mc IPHERSON , Suture Forceps	91
Knives, Goniotomy	174	Mc IPHERSON-KELMAN , Tying Forceps with platform	92
Knives, Keratoplasty	175	Measuring Instruments	143, 194
Knives, Scleral	174	MENDEZ , Measuring Instruments Degree	194
KNOLLE , Capsule Polisher	202	MEYHOEFER , Chalazion Curettes	185
KNOLLE , Iris Hooks	156	Micro Needle Holders	128-133
KNOLLE , Lens Nucleus Spatulas	187	Micro Needle Holders with pen-type handle	128, 129, 130, 130

	Page		Page
Micro Needle Holders with Tungsten Carbide Inserts	127, 128	Punches	154
Micro Scissors	112-118	R	
Micro Scissors, Adventitia	114, 116	Radial Markers	190
Micro Scissors, Dissection	113, 116	Razor Blades	124
Micro Scissors, Nerve	116	REILL , Micro Needle Holders with pen-type handle	130
MICRO-ADSON , Dressing Forceps	82	Remover, Rust Ring	195
MICRO-ADSON , Tissue Forceps	82	RENTSCH , Lens Manipulators	161
Mini Scissors	107	Retinal Detachment Hooks	154
MOD. BONN , Fine Scissors	101	Retractors, Lacrimal Sac	170
MOD. BONN , Iris Forceps	86, 87	Retractors, Orbital	171
MOD. BONN , Irrigation Cannulas	198	RIBBON , Eye Scissors	105
MOD. BONN , Tying Forceps with platform	92	ROEDER , Towel Forceps	79
MOD. DORTMUND , Phaco Spatulas	187	ROLLET , Delicate Hooks	155
MOD. HAMBURG , Keratome	175	ROSEN , Phaco Splitter Hooks	159
MOD. TÜBINGEN , Suture Forceps	92	Rotators, Lens Nucleus	158
MOD. TÜBINGEN-VANNAS , Secondary Cataract Scissors	108	RUEDEMANN , Lacrimal Dilators	164
MOLDESTAD , Delicate Hooks	149	Rulers, Limbal Incision	193
MOORFIELD , Suture Forceps	90	Rust Ring Remover	195
MOSQUITO, HALSTED Artery Forceps	78	RYDER/FRENCH-EYE , TUC Needle Holders	126
MULDOON , Lacrimal Dilators	164	S	
Muscle Hooks	154	SATO , Corneal Knives	173
Muscular Forceps	94, 95	SATTLER , Muscular Forceps	94
N		SAUER , Eye Specula	168
NAGAHARA , Phaco Chopper Blade	159	SAUTTER , Air Injection Cannulas	199
Nasal Specula	155	SAUTTER , Orbital Spatulas	171
Needle Holders, Micro	128-133	Scalpel Blades	122, 123
Needle Holders, Micro with pen-type handle	128, 129, 130, 133	Scalpel Handles	121, 122
Needle Holders, Micro with Tungsten Carbide Inserts	127, 128	Scarifiers, Corneal	173
Needles, Eye	204	SCHAEDEL , Towel Forceps	79
Needles, Foreign Body	176-178	SCHEPENS , Orbital Retractors	171
NERVE , Micro Scissors	116	SCHEPENS , Sklera Depressors	172
NEW ORLEANS , Lens Scoops	186	SCHIOETZ , Tonometers	193
NOYES , Iris Scissors	106	SCHOCKET , Sklera Depressors	172
NOYES , Micro Corneal Scissors	112	SCHOTT , Eye Specula	167
Nucleus Dividing and Separating Hook	159	Scissors, Capsulotomy	109
O		Scissors, Corneal	87-90
OB , Eye Needles	204	Scissors, Eye	101-105
OBSTBAUM , Lens Spatulas	187	Scissors, Fine	101
O'CONNOR , Delicate Hooks	154	Scissors, Iris	102, 103, 106, 107
OG , Eye Needles	204	Scissors, Micro	112-118
Ophthalmoscope	144	Scissors, Mini	107
Optical Zone Markers	190	Scissors, Secondary Cataract	108, 109
Orbital Retractors	171	Scissors, Strabismus	103, 112
Orbital Spatulas	171	Scissors, Tenotomy	104, 109
OSHER , Lens Nucleus Manipulators	158	Scissors, Vitrectomy	182
P		Scleral Depressors	172
PARK-MAUMENEE , Eye Specula	167	Scleral Fixation Rings	195
PARTSCH , Chisels	151	Scleral Knives	174
PARTSCH , Mallet	151	Scleral Marker	172
PATON , Micro Needle Holders	132	Scrapers, Capsule	202
PAUFIQUE , Keratoplasty Knives	175	Secondary Cataract Scissors	108, 109
PAUFIQUE , Suture Forceps	93	Sets	55-64
PEARCE-KNOLLE , Irrigating Vectis	201	Setting Forceps	77
PEERS , Towel Forceps	80	SIMCOE , Cortex Extractors	200
Phaco Chopper Blade	159	SIMCOE , Irrigating Lens Nucleus Loops	201
Phaco Hooks	159	SIMCOE , Suction-and Irrigation Cannulas	199
Phaco Spatulas	187	SINSKEY , Lens Manipulators	160
Phaco Splitter Hooks	159	SMITH-POTTS , Micro Needle Holders	132
PHAKO BARRAQUER , Eye Specula	166	SMITH-POTTS , Micro Needle Holders with Tungsten Carbide Inserts	128
Pigtail Probes	165	Smoothers, Flap	171
PLEY , Eye Specula	168	SNELLEN , Entropium Forceps	95
Polisher, Capsule	202	SNELLEN , Lens Scoops	186
POTTS-SMITH , Micro Needle Holders	132	Spatulas, Cyclodialysis	188
POTTS-SMITH , Micro Needle Holders with Tungsten Carbide Inserts	128	Spatulas, Iris	189
PRINCE , Muscular Forceps	94	Spatulas, Lens	187
Probes, Lacrimal	163	Spatulas, Lens Nucleus	187
Probes, Pigtail	165	Spatulas, Orbital	171
Probes, Trabecular	165	Spatulas, Phaco	187
Ptosis Forceps	96	Specula, Eye	166-169

	Page		Page
SPENCER , Ligature Scissors	106		
Sphenoid Punches	155		
Spoons, Cataract	185, 186	Z	
Spoons, Corneal Button Transfer	185	ZIEGLER , Cilia Forceps	83
Spoons, Enucleation	184	ZIEGLER , Discission Knives	173
Spoons, Exenteration	184		
Spuds, Foreign Body	176-178		
ST. MARTIN , Suture Forceps	91		
STEVENS , Iris Forceps	85		
STEVENS , Micro Needle Holders	132		
STEVENS , Tenotomy Hooks	155		
STEVENS , Tenotomy Scissors	104		
STEVENSON , Lacrimal Sac Retractors	170		
STILLE , Foreign Body Instruments	178		
STORZ , Corneal Burrs	196		
Strabismus Forceps	92		
Strabismus Hooks	154		
Strabismus Scissors	103, 112		
Suture Forceps	90-93		
Suture Placement Markers	192		
T			
Tenotomy Hooks	155		
Tenotomy Scissors	104, 109		
TERSON , Capsular Forceps	88		
THORNTON , Double Corneal Markers	192		
THORNTON , Fixation Rings	194		
THORNTON , Limbal Incision Rulers	192		
T-Incision Markers	190		
Tissue Forceps	82		
TOHOKU-JAPAN , Towel Forceps	80		
Tonometers	193		
TOOK , Corneal Knives	173		
Towel Forceps	79, 80		
Trabecular Probes	165		
Trephines, Corneal	195, 196		
Trephines, Scleral	196		
TROUTMAN (CORNEAL) , Iris Forceps	88		
TROUTMAN , Alpha-Chymotrypsin Cannulas	203		
TROUTMAN , Corneal Scissors	110		
TROUTMAN , Micro Needle Holders with pen-type handle	130		
TROUTMAN-BARRAQUER , Micro Needle Holders w. pen-type handle	129		
TROUTMAN-CHRIS , Blade Breakers	124		
TÜBINGEN , Suture Forceps	92		
TÜBINGEN-VANNAS , Secondary Cataract Scissors	108		
Tying Forceps with platform	93		
TYRELL , Iris Hooks	157		
V			
VANNAS , Secondary Cataract Scissors	108		
VANNAS-MOD. TÜBINGEN , Secondary Cataract Scissors	108		
Vectis, Irrigating	201		
ping Forceps	183		
Vitrectomy Instruments	182, 183		
Vitrectomy Scissors	182		
W			
WECKER , Iris Scissors	106		
WECKER , Iris Spatulas	189		
WELLS , Enucleation Spoons	184		
WELSH , Cortex Extractors	200		
WELSH-GILLS , Capsulotomy Scissors	109		
WELSH-GILLS , Cortex Extractors	200		
WEST , Gauges	155		
WESTCOTT , Strabismus Scissors	112		
WESTCOTT , Tenotomy Scissors	109		
WHEELER , Discission Knives	173		
WILDER , Lacrimal Dilators	164		
WILLIAMS , Eye Specula	166		
WILMER , Eye Scissors	103		
WORST , Pigtail Probes	165		

Índice alfabético

	Página		Página
A			
ADSON, MICRO Pinzas de disección	82	BROWN-ADSON , Pinzas de disección con dientes	82
ADSON, MICRO Pinzas de disección con dientes	82	BUNGE, Cucharas para exenteración	184
ADSON , Pinzas de disección	82	BUNNKATU, Ganchos para manipular de núcleo	159
ADSON , Pinzas de disección con dientes	82	BURCH, Horquilla fijadora	155
ADSON-BROWN , Pinzas de disección con dientes	82	BURCH-LESTER, Blefarostatos	168
ADVENTITIA , Micro Tijeras	114, 116	C	
AGRICOLA , Separadores para saco lacrimal	170	Cables de conexión	209
Agujas oculares	204	Cánulas Alpha-Chymotrypsin	203
Agujas para cuerpos extraños	176-178	Cánulas cistótomo	203
ANEL , Cánulas lacrimales	200	Cánulas de irrigación para cámara anterior	198, 199
Anillo removedor de óxido	195	Cánulas lacrimales	200
Anillos de fijación	194, 195	Cánulas para núcleo con irrigación	201
ANIS , Marcadores para sutura	192	Cánulas para ciclodíalisis	203
ANIS , Marcadores radiales	190	Cánulas para inyección	201
ARLT , Asas para catarata	186	Cánulas para inyectar aire	199
ARLT-FISCHER , Pinzas para iris	85	Cánulas para irrigación	199
ARRUGA , Micro-porta-agujas	132	CASTROVIEJO, Blefarostatos	167
ARRUGA , Pinzas capsulares	89	CASTROVIEJO, Círculo	143
ARRUGA , Protector	171	CASTROVIEJO, Cucharas para transferir la córnea	185
ARRUGA-KALT , Micro-porta-agujas	132	CASTROVIEJO, Dilatadoras para canal lacrimal	165
Asas para catarata	186	CASTROVIEJO, Espátulas para ciclodíalisis	188
Asas para cristalino con irrigación	201	CASTROVIEJO, Micro-porta-agujas	131
AYER , Pinzas de chalazión	95	CASTROVIEJO, Micro-porta-agujas, carburo de Tungsteno	127, 128
B			
BACKHAUS , Pinzas de campo	79	CASTROVIEJO, Micro-porta-agujas con mango redondo	133
BARKAN , Cuchillos para goniotomía	174	CASTROVIEJO, Pinzas capsulares	88
BARRAQUER PHAKO , Blefarostatos	166	CASTROVIEJO, Pinzas de fijación	90
BARRAQUER , Blefarostatos	166	CASTROVIEJO, Pinzas para sutura	91
BARRAQUER , Micro-porta-agujas con mango redondo	129	CASTROVIEJO, Pinzas-tijeras para córnea	109, 110
BARRAQUER , Pinzas de depilatorias	83	CASTROVIEJO, Pinzas-tijeras para iridectomía	107
BARRAQUER , Pinzas para la cámara anterior	91	CASTROVIEJO, Trépanos corneales	195
BARRAQUER , Pinzas-tijeras para iridectomía	107	CASTROVIEJO-BARRAQUER, Espátulas para ciclodíalisis	188
BARRAQUER-CASTROVIEJO , Espátulas para ciclodíalisis	188	CASTROVIEJO-KALT, Micro-porta-agujas	132
BARRAQUER-COLIBRI , Blefarostatos	166	CHADWICK, Tijeras oculares	104
BARRAQUER-FINO , Espátulas para ciclodíalisis	188	CHRIS-TROUTMAN, Pinzas para romper hojas	124
BARRAQUER-KATZIN (COLIBRI) , Pinzas para iris	87, 88	Cinceles	151
BARRAQUER-KATZIN , Pinzas-tijeras para córnea	111	Cinceles para cuerpos extraños	176-178
BARRAQUER-KRATZ , Blefarostatos	166	Círculo	143
BARRAQUER-TROUTMAN , Micro-porta-agujas con mango redondo	129	CITELLI, Pinzas osteótomos	154
BECHERT , Ganchos para voltear núcleo	158	Clamps Bulldog	77
BECHERT-JAFFE , Ganchos para voltear núcleo	158	CLAYMAN, Ganchos para voltear núcleo	158
BEER , Pinzas de depilatorias	83	COLIBRI-BARRAQUER, Blefarostatos	166
BELL , Erisiphake	202	COLLIN, Mangos de bisturíes	121
BERENS , Pinzas musculares	95	COOK, Blefarostatos	168
BERKE , Pinzas de chalazión	96	CORCELLE, Blefarostatos	166
BINKHORST , Pinzas capsulares	89	Cucharas para enucleación	184
BISHOP-HARMON , Cánulas de irrigación para cámara anterior	198	Cucharas para exenteración	184
BISHOP-HARMON , Pinzas para iris	87	Cucharas para transferir la córnea	185
Bisturí de diamante	180-181	Cucharillas para catarata	186
BLASCOVICS , Pinzas musculares	94	Cucharillas para chalazión	185, 186
Blefarostatos	166-169	Cuchillos para catarata	174
BÖHLER , Pinzas-gubias	151	Cuchillos para discisión	173
BONACCOLTO , Pinzas para sutura	92	Cuchillos para esclerótica	174
BONN MOD. , Pinzas para sutura	92	Cuchillos para goniotomía	174
BONN , Anillos de fijación	194	Cuchillos para la córnea	173
BONN , Cánulas para irrigación	198	Cuchillos para queratoplástica	175
BONN , Cuchillos para esclerótica	174	CULLER, Espátulas para iris	189
BONN , Ganchos para iris	156	CUSHING, Ganchos	149
BONN , Pinzas para iris	86, 87	D	
BONN , Tijeras finas	101	DAVIEL, Cucharillas para catarata	186
BORES , Marcadores axiales	190	DAVIS, Cinceles para cuerpos extraños	177
BOWMAN , Blefarostatos	166	DEITZ, Medidor de profundidad	194
BOWMAN , Sondas exploradoras para canal lacrimal	163	Depresores	172
		DERF, Porta-agujas	126
		DERF, Porta-agujas con bocas de carburo de Tungsteno	126
		DESMARRES, Ganchos	155

DESMARRES, Pinzas de chalazión	95	GREEN , Ganchos de músculos	154
DIEFFENBACH , Clamps Bulldog	77	GREEN , Pinzas de fijación	89
DIETHRICH , Micro-porta-agujas con bocas de carburo de Tungsteno	128	Gubias	155
Dilatadoras para canal lacrimal	164, 165	Gubias para cuerpos extraños	176-178
DISSECTION , Micro Tijeras	114, 116	GUTHRIE , Ganchos	155
DIX , Instrumento para cuerpos extraños	178	H	
DORTMUND , Espátulas para fako	187	HALLE-HARTMANN , Espéculos nasales	155
DOUGLAS , Pinzas de depilatorias	83	HALSEY , Porta-agujas	126
DRYSDALE , Ganchos para posicionar cristalino	159	HALSEY , Porta-agujas con bocas de carburo de Tungsteno	126
E		HALSTED-MOSQUITO , Pinzas hemostáticas	78
ELLIOT , Trépanos corneales	196	HAMBURG , Querátomo	175
ELLIS , Cinceles para cuerpos extraños	177	HARMON-BISHOP , Cánulas de irrigación para cámara anterior	198
ELSCHNIG , Pinzas de fijación	90	HARMON-BISHOP , Pinzas para iris	87
ERHARDT , Pinzas de entropión	95	HARMS , Pinzas de ligadura con plataforma	93
Erisiphake	202	HARMS , Sondas trabeculares	165
Espátulas orbitales	171	HARTMANN , Pinzas hemostáticas	78
Espátulas para ciclodíálisis	188	HARTMANN-HALLE , Espéculos nasales	155
Espátulas para fako	187	HEBRA , Cucharillas para chalazión	186
Espátulas para iris	189	HESS , Pinzas para iris	86
Espátulas para manipular	187	HESS-GILL , Pinzas para iris	88
Espátulas para manipular	187	HIRSCHMANN , Ganchos para iris	157
Espátulas para núcleo cristalino	187	HIRSCHMANN, IOL Espátulas para manipular	187
Espéculos nasales	155	HOFFER , Marcadores para centro óptico	190
Extractor para corteza	200	Hojas de afeitar	124
F		Hojas de bisturíes	122, 123
FAULKER , Pinzas para tener cristalino	97	HOPKINS-JOHNS , Clamps Bulldog	77
FINO-BARRAQUER , Espátulas para ciclodíálisis	188	HOPKINS-JOHNS , Pinzas para poner	77
FISCHER-ARLT , Pinzas para iris	85	Horquilla fijadora	155
FLIERINGA , Anillos de fijación	195	I	
FOERSTER , Pinzas para iris	86	Imán oftálmico con asa para cuerpos extraños	178
FRANCESCHETTI , Trépanos corneales	195	Instrumentos de vitrectomía	182, 183
FRANCIS , Cinceles para cuerpos extraños	177	Instrumentos para medidas	143
FRAZIER , Ganchos	147	J	
FRENCH-EYE/Ryder , Porta-agujas, carburo de Tungsteno	126	JACOBSON , Micro-porta-agujas	131
Fresas corneales	195, 196	JACOBSON , Micro-porta-agujas con bocas de carburo de Tungsteno	128
FRIEDMAN , Pinzas-gubias	151	JAEGER , Placa para párpados	170
FUCHS-GILL , Pinzas para iris	88	JAFFE , Blefarostatos	170
G		JAFFE , Espátulas para manipular	187
Ganchos	147-150	JAFFE-BECHERT , Ganchos para voltear núcleo	158
Ganchos de músculos	154	JAFFE-KNOLLE , Ganchos para iris	156
Ganchos de tenotomía	155	JAFFE-MALTZMANN , Ganchos para posicionar cristalino	161
Ganchos para desprendimiento de retina	154	JAMESON , Calibrador	143
Ganchos para estrabismo	154	JAMESON , Ganchos de músculos	154
Ganchos para fako	159	JAMESON , Pinzas musculares	94
Ganchos para iris	156, 157	JAPAN-TOHOKU , Pinzas de campo	80
Ganchos para posicionar cristalino	158, 160, 161	JENSEN , Pulidor para cápsula	202
eo	158	JOHNS-HOPKINS , Clamps Bulldog	77
GASS , Ganchos para desprendimiento de retina	154	JOHNS-HOPKINS , Pinzas para poner	77
GASS , Marcadores de esclerótica	172	JONES , Pinzas de campo	79
GILL , Cuchillos para la córnea	173	K	
GILL , Pinzas para iris	88	KALT , Micro-porta-agujas	132
GILL-FUCHS , Pinzas para iris	88	KALT , Micro-porta-agujas con bocas de carburo de Tungsteno	128
GILL-HESS , Pinzas para iris	88	KALT-ARRUGA , Micro-porta-agujas	132
GILLIES , Ganchos	147	KALT-CASTROVIEJO , Micro-porta-agujas	132
GILLS-WELSH , Extractor para corteza	200	KATZIN , Pinzas-tijeras para córnea	110
GILLS-WELSH , Tijeras para capsulotomía	109	KATZIN-BARRAQUER (COLIBRI) , Pinzas para iris	87, 88
GOLF-CLUB , Cinceles para cuerpos extraños	177	KATZIN-BARRAQUER , Pinzas-tijeras para córnea	111
GONNIN , Marcadores Amsler	192	KELMAN , Cánulas cistótomo	203
GRADLE , Pinzas de depilatorias	83	KELMAN , Cánulas para ciclodíálisis	203
GRAEFE , Cucharillas para catarata	186	KELMAN-McPHERSON , Pinzas para sutura	92
GRAEFE , Cuchillos para catarata	174	KERRISON , Pinzas para seno esfenoidal	155
GRAEFE , Ganchos	154	KILNER , Ganchos	147
GRAEFE , Ganchos para estrabismo	154	KIRBY , Pinzas para iris	87
GRAEFE , Pinzas de fijación	89	KLEINERT-KUTZ , Ganchos	147
GRAEFE , Pinzas para iris	84	KNAPP , Cucharas para transferir la córnea	185
GRAEFE , Quistótomos	175	KNAPP , Ganchos	155
GRAEFE , Tijeras oculares	103	KNOLLE , Espátulas para núcleo cristalino	187
GRAETHER , Cánula	202	KNOLLE , Ganchos para iris	156
GRANDON , Marcadores para T-Inzisión	190	KNOLLE , Pulidor para cápsula	202

	Página		Página
KNOLLE-JAFFE , Ganchos para iris	156	N	
KNOLLE-PEARCE , Asas para cristalino con irrigación	201	NAGAHARA , Facó Chopper hojas	159
KRATZ , Cánulas cistótomo	203	NERVE , Micro Tijeras	116
KRATZ , Pulidor para cápsula	202	NEW ORLEANS , Asas para catarata	186
KRATZ-BARRAQUER , Blefarostatos	166	NOYES , Micro Tijeras	112
KUHNT , Rescadores para la córnea	173	NOYES , Pinzas-tijeras para iridectomía	106
KUTZ-KLEINERT , Ganchos	147	O	
L		OB , Agujas oculares	204
LA GRANGE , Tijeras oculares	104	OBSTBAUM , Espátulas para manipular	187
LAMPERT , Pinzas de chalazión	96	O'CONNOR , Ganchos	154
LANCASTER , Blefarostatos	168	Oftalmoscopio	144
LASIK , Manipulador para flap de córnea	171	OG , Agujas oculares	204
LESTER , Ganchos para posicionar cristalino	161	OSHER , Ganchos para posicionar cristalino	158
LESTER , Pinzas de fijación	90	P	
LESTER-BURCH , Blefarostatos	168	PARK-MAUMENEE , Blefarostatos	167
LEWICKY , Ganchos para posicionar cristalino	160	PARTSCH , Cinceles	151
LEWIS , Asas para catarata	186	PARTSCH , Martillos	151
LIEBERMAN , Blefarostatos	169	PATON , Micro-porta-agujas	132
LINDSTROM , Marcadores corneales	191	PAUFIQUE , Chuchillos para queratoplástica	175
LIPPMAN , Espátulas para núcleo cristalino	187	PAUFIQUE , Pinzas para sutura	93
LITTAUER , Pinzas de depilatorias	83	PEARCE-KNOLLE , Asas para cristalino con irrigación	201
LORNA , Pinzas de campo	80	PEERS , Pinzas para compresas	80
LU , Marcadores corneales Lasik	191	PHAKO BARRAQUER , Blefarostatos	166
LUER , Pinzas-gubias	151	Pincel	205
M		Pinzas capsulares	88, 89
MALONEY , Queratómetros	193	Pinzas capsulorhexis	97
MALTMANN-JAFFE , Ganchos para posicionar cristalino	161	Pinzas de campo	79, 80
Mangos de bisturíes	121, 122	Pinzas de chalazión	95, 96
Manipulador para flap de córnea	171	Pinzas de depilatorias	83
Marcadores axiales	190	Pinzas de disección	82
Marcadores corneales	191, 192	Pinzas de disección con dientes	82
Marcadores de esclerótica	172	Pinzas de entropión	95
Marcadores para centro óptico	190	Pinzas de fijación	89, 90
Marcadores para incisión limbal	192	Pinzas de ligadura con plataforma	93
Marcadores para suturas	192	Pinzas de vitrectomía	183
Marcadores para T-inzision	190	Pinzas hemostáticas	78
Marcadores radiales	190	Pinzas musculares	94, 95
Martillos	151	Pinzas osteótomas	154
MARTIN , Trépanos corneales	195	Pinzas para Bi-Coagulación	209
MAUMENEE-PARK , Blefarostatos	167	Pinzas para compresas	79, 80
McDONALD, Pinzas capsulorhexis	97	Pinzas para iris	84-88
McINTYRE, Cánulas para cámara anterior	199	Pinzas para poner	77
McINTYRE, Cánulas para irrigación	198	Pinzas para romper hojas	124
McPHERSON, Pinza para sutura	91	Pinzas para seno esfenoidal	155
McPHERSON-KELMAN, Pinzas para sutura	92	Pinzas para sutura	90-93
Medidor de profundidad	194	Pinzas para tener cristalino	97
MENDEZ , Instrumentos para medidas	194	Pinzas-gubias	151
MEYHOEFER , Cucharillas para chalazión	185	Pinzas-tijeras para catarata secundaria	108, 109
Micro Tijeras	112-118	Pinzas-tijeras para córnea	87-90
Micro Tijeras, Adventitia	114, 116	Pinzas-tijeras para iridectomía	102, 106, 107
Micro Tijeras, Dissection	114, 117	Pinzas-tijeras para tenotomía	104, 109
Micro Tijeras, Nerve	116	Placa para párpados	170
MICRO-ADSON , Pinzas de disección	82	PLEY , Blefarostatos	168
MICRO-ADSON , Pinzas de disección con dientes	82	Porta-agujas micro con bocas de carburo de Tungsteno	127, 128
Micro-porta-agujas	128-133	Porta-agujas micro con mango redondo	128, 129, 130, 133
Micro-Porta-agujas con bocas de carburo de Tungsteno	127, 128	POTTS-SMITH , Micro-porta-agujas	132
Micro-porta-agujas con mango redondo	128, 119, 130, 133	POTTS-SMITH , Micro-porta-agujas, carburo de Tungsteno	128
MOD. BONN , Cánulas para irrigación	198	PRINCE , Pinzas musculares	94
MOD. BONN , Pinzas para iris	86, 87	Protector	171
MOD. BONN , Pinzas para sutura	92	Protectores de ojos	205
MOD. BONN , Tijeras finas	101	Pulidor para cápsula	202
MOD. DORTMUND , Espátulas para fako	187	Q	
MOD. HAMBURG , Querátomo	175	Queratómetros	193
MOD. TÜBINGEN , Pinzas para sutura	92	Querátomo	175
MOD. TÜBINGEN-VANNAS , Pinzas-tijeras para catarata secundaria	108	Quistótomos	175
MOLDESTAD , Ganchos	149	R	
MOORFIELD , Pinzas para sutura	90	REILL , Micro-porta-agujas con mango redondo	130
MOSQUITO-HALSTED , Pinzas hemostáticas	78	RENTSCH , Ganchos para posicionar cristalino	161
MULDOON , Dilatadoras para canal lacrimal	164	Rescadores para la córnea	173

RIBBON , Tijeras oculares	105	V	
ROEDER , Pinzas de campo	79	VANNAS MOD. TÜBINGEN , Pinzas-tijeras para catarata secundaria	108
ROLLET , Ganchos	155	VANNAS , Pinzas-tijeras para catarata secundaria	108
ROSEN , Ganchos para faco	159	W	
RUEDEMANN , Dilatadoras para canal lacrimal	164	WECKER , Espátulas para iris	189
RYDER/FRENCH-EYE , Porta-agujas, de carburo de Tungsteno	126	WECKER , Pinzas-tijeras para iridectomía	106
S		WELLS , Cucharas para enucleación	184
s para la córnea	173	WELSH , Extractor para corteza	200
SATTLER , Pinzas musculares	94	WELSH-GILLS , Extractor para corteza	200
SAUER , Blefarostatos	168	WELSH-GILLS , Tijeras para capsulotomía	109
SAUTTER , Cánulas para inyectar aire	199	WEST , Gubias	155
SAUTTER , Espátulas orbitales	171	WESTCOTT , Micro Tijeras	112
SCHAEDEL , Pinzas para compresas	79	WESTCOTT , Pinzas-tijeras para tenotomía	109
SCHEPENS , Depresores	172	WHEELER , Cuchillos para discisión	173
SCHEPENS , Separadores orbitales	171	WILDER , Dilatadoras para canal lacrimal	164
SCHIOETZ , Tonómetros	193	WILLIAMS , Blefarostatos	166
SCHOCKET , Depresores	172	WILMER , Tijeras oculares	103
SCHOTT , Blefarostatos	167	WORST , Sondas Pigtail	165
Separadores orbitales	171	Z	
Separadores para saco lacrimal	170	ZIEGLER , Cuchillos para discisión	173
Sets	55-64	ZIEGLER , Pinzas de depilatorias	83
SIMCOE , Cánulas para irrigación y aspiración	199		
SIMCOE , Cánulas para manipulación de núcleo	201		
SIMCOE , Extractor para corteza	200		
SINSKEY , Ganchos para posicionar cristalino	160		
SMITH-POTTS , Micro-porta-agujas	132		
SMITH-POTTS , Micro-porta-agujas, carburo de Tungsteno	128		
SNELLEN , Asas para catarata	186		
SNELLEN , Pinzas de entropión	95		
Sondas exploradoras para canal lacrimal	163		
Sondas pigtail	165		
Sondas trabeculares	165		
SPENCER , Tijeras para ligaduras	106		
ST. MARTIN , Pinzas para sutura	91		
STEVENS , Ganchos de tenotomía	155		
STEVENS , Micro-porta-agujas	132		
STEVENS , Pinzas para iris	85		
STEVENS , Tijeras para tenotomía	104		
STEVENSON , Separadores para saco lacrimal	170		
STILLE , Instrumento para cuerpos extraños	178		
STORZ , Fresas corneales	196		
T			
TERSON , Pinzas capsulares	88		
THORNTON , Anillos de fijación	194		
THORNTON , Marcadores corneales	192		
THORNTON , Marcadores incisión limbal	192		
Tijeras de vitrectomía	182		
Tijeras finas	101		
Tijeras Micro	112-118		
Tijeras oculares	101-105		
Tijeras para capsulotomía	109		
Tijeras para estrabismos	103		
Tijeras para iridectomía	102, 106, 107		
Tijeras para ligaduras	106		
Tijeras para tenotomía	104, 109		
TOHOKU-JAPAN , Pinzas de campo	80		
Tonómetros	193		
TOOK , Cuchillos para la córnea	173		
Trépanos corneales	195, 196		
TROUTMAN (CORNEAL) , Pinzas para iris	88		
TROUTMAN , Cánulas Alpha-Chymotrypsin	203		
TROUTMAN , Micro-porta-agujas con mango redondo	130		
TROUTMAN , Pinzas-tijeras para córnea	110		
TROUTMAN-BARRAQUER , Micro-porta-agujas con mango redondo	129		
TROUTMAN-CHRIS , Pinzas para romper hojas	124		
TÜBINGEN MOD. , Pinzas para sutura	92		
TÜBINGEN-VANNAS , Pinzas-tijeras para catarata secundaria	108		
TYRELL , Ganchos para iris	157		

Index

	Page		Page
A			
ADSON, MICRO Pincés à dissection	82	BUNGE , Cuillers à éviscération	184
ADSON, MICRO Pincés à griffes	82	BUNNKATU , Crochets pour manipuler	159
ADSON , Pincés à dissection	82	BURCH , Pique de fixation	155
ADSON , Pincés à griffes	82	BURCH-LESTER , Blépharostats	168
ADSON-BROWN , Pincés à griffes	82	C	
ADVENTITIA , Micro Ciseaux	114, 116	Câbles de raccordement	209
AGRICOLA , Ecarteurs à sac lacrymal	170	Canules à chambre antérieure	198, 199
Aiguilles à corps étrangers	176-178	Canules à Injection	201
Aiguilles ophtalmiques	204	Canules à injection Alpha-Chimo-Trypsine	203
Aimant oculaire	178	Canules à injection d'air	199
ANEL , Canules à voies lacrymales	200	Canules à voies lacrymales	200
ANIS , Marqueurs	190	Canules cystotomes	203
ANIS , Marqueurs à sutures	192	Canules gratteuses	202
Anneaux de fixation	194, 195	Canules irrigatrice	198
Anses à cataracte	186	Canules pour cyclodialyse	203
Anses à cristallin avec irrigation	201	CASTROVIEJO , Blépharostats	167
ARLT , Anses à cataracte	186	CASTROVIEJO , Ciseaux à iridectomie	107
ARLT-FISCHER , Pincés à iris	85	CASTROVIEJO , Ciseaux corneales	109, 110
ARRUGA , Micro-porte-aiguilles	132	CASTROVIEJO , Compas	143
ARRUGA , Pincés capsulaires	89	CASTROVIEJO , Cuillers à transférer la cornée	185
ARRUGA , Protecteur	171	CASTROVIEJO , Dilatateurs pour le canal lacrymal	165
ARRUGA-KALT , Micro-porte-aiguilles	132	CASTROVIEJO , Micro-porte-aiguilles	131
AYER , Pincés à chalazion	95	CASTROVIEJO , Micro-porte-aiguilles à manches rondes	133
B			
BACKHAUS , Pincés à champs	79	CASTROVIEJO , Micro-porte-aiguilles, carbure de tungstène	127, 128
Bandeaux pour les yeux	205	CASTROVIEJO , Pincés à fixer	90
BARKAN , Couteaux à goniotomie	174	CASTROVIEJO , Pincés capsulaires	88
BARRAQUER , Blépharostats	166	CASTROVIEJO , Pincés pour sutures	91
BARRAQUER , Ciseaux à iridectomie	107	CASTROVIEJO , Porte-aiguilles à mors en carbure de tungstène	127, 128
BARRAQUER , Micro-porte-aiguilles à manches rondes	129	CASTROVIEJO , Spatules pour cyclodialyse	188
BARRAQUER , Pincés à épiler les cils	83	CASTROVIEJO , Trépans kéroplastie	195
BARRAQUER , Pincés pour la chambre antérieure	91	CASTROVIEJO-BARRAQUER , Spatules pour cyclodialyse	188
BARRAQUER-CASTROVIEJO , Spatules pour cyclodialyse	188	CASTROVIEJO-KALT , Micro-porte-aiguilles	132
BARRAQUER-COLIBRI , Blépharostats	166	CHADWICK , Ciseaux oculaires	104
BARRAQUER-FINO , Spatules pour cyclodialyse	188	CHRIS-TROUTMAN , Pincettes pour casser les lames	124
BARRAQUER-KATZIN (COLIBRI) , Pincés à iris	87, 88	Ciseaux à iridectomie	106, 107
BARRAQUER-KATZIN , Ciseaux corneales	111	Ciseaux à ligatures	106
BARRAQUER-KRATZ , Blépharostats	166	Ciseaux à strabisme	103
BARRAQUER-PHAKO , Blépharostats	166	Ciseaux à ténotomie	104, 109
BARRAQUER-TROUTMAN , Micro-porte-aiguilles à manches rondes	129	Ciseaux corneales	87-90
BECHERT , Crochets pour tourner	158	Ciseaux fins	101
BECHERT-JAFFE , Crochets pour tourner	158	Ciseaux Micro	112-118
BEER , Pincés à épiler les cils	83	Ciseaux oculaires	101-105
BELL , Erisiphaque capsulaire	202	Ciseaux pour capsulotomie	109
BERENS , Pincés musculaires	95	Ciseaux-burins	151
BERKE , Pincés à chalazion	96	Ciseaux-burins à corps étrangers	176-178
Bi-Coagulation, Pincés	209	CITELLI , Pince ostéotome	154
BINKHORST , Pincés capsulaires	89	Clamps Bulldog	77
BISHOP-HARMON , Canules à chambre antérieure	198	CLAYMAN , Crochets pour tourner	158
BISHOP-HARMON , Pincés à iris	87	COLIBRI-BARRAQUER , Blépharostats	166
BLASCOVICS , Pincés musculaires	94	COLLIN , Manches pour bistouris	121
Blépharostats	166-169	Compas	143
BÖHLER , Pince-gouges	151	COOK , Blépharostats	168
BONACCOLTO , Pincés pour sutures	92	CORCELLE , Blépharostats	166
BONN , Anneaux de fixation	194	Couteaux à cataracte	174
BONN , Canules irrigatrice	198	Couteaux à discision	173
BONN , Ciseaux fins	101	Couteaux à goniotomie	174
BONN , Couteaux pour la sclère	174	Couteaux de diamant	180-181
BONN , Crochets à iris	156	Couteaux lenceolaires	175
BONN , Pincés à iris	86, 87	Couteaux pour kéroplastie	175
BORES , Marqueurs axiales	190	Couteaux pour la sclère	174
BOWMAN , Blépharostats	166	Crochets à iris	156, 157
BOWMAN , Sondes exploratrices pour le canal lacrymal	163	Crochets à phaco	159
BROWN-ADSON , Pincés à griffes	82	Crochets à strabisme	154
		Crochets de décollement de la rétine	154
		Crochets manipulateurs à cristallin	158, 159

	Page		Page
Crochets musculaires	154	GRAEFE , Ciseaux oculaires	103
Crochets pour tenotomie	155	GRAEFE , Couteaux à cataract	174
Crochets pour tourner	158	GRAEFE , Crochets à strabisme	154
Crochets très fins	147-150	GRAEFE , Crochets très fins	154
Cuillers à cataracte	185, 186	GRAEFE , Cuillers à cataracte	186
Cuillers à chalazion	185, 186	GRAEFE , Cystotomes	175
Cuillers à énucléation	184	GRAEFE , Pincés à iris	84
Cuillers à éviscération	184	GRAEFE , Pincés à fixer	89
Cuillers pour transférer la cornée	185	GRAETHER , Canules	202
CULLER , Spatules à iris	189	GRANDON , Marqueurs	190
CUSHING , Crochets très fins	149	Grattoirs cornées	173
Cystotomes	175	GREEN , Crochets musculaires	154
D		GREEN , Pincés à fixer	89
DAVIEL , Cuillers à cataracte	186	GUTHRIE , Crochets très fins	155
DAVIS , Ciseaux-Burins à corps étrangers	177	H	
DEITZ , Jauge de profondeur	194	HALLE-HARTMANN , Spéculum naseau	155
Dépresseurs	172	HALSEY , Porte-aiguilles	126
DERF , Porte-aiguilles	126	HALSEY , Porte-aiguilles à mors en carbure de tungstène	126
DERF , Porte-aiguilles à mors en carbure de tungstène	126	HALSTED-MOSQUITO , Pincés hémostatiques	78
DESMARRES , Crochets très fins	155	HAMUBRG , Couteaux lanceolaires	175
DESMARRES , Pincés à chalazion	95	HARMON-BISHOP , Canules à chambre antérieure	198
DIEFFENBACH , Clamps Bulldog	77	HARMON-BISHOP , Pincés à iris	87
DIETHRICH , Micro-porte-aiguilles à mors en carbure de tungstène	128	HARMS , Pincés à ligature avec plate-forme	93
Dilatateurs pour le canal lacrymal	164, 165	HARMS , Sondes trabéculaires	165
DISSECTION , Micro Ciseaux	114, 116	HARTMANN , Pincés hémostatiques	78
DIX , Instrument à corps étrangers	178	HARTMANN-HALLE , Spéculum naseau	155
DORTMUND , Spatules à phaco	187	HEBRA , Cuillers à chalazion	186
DOUGLAS , Pincés à épiler les cils	83	HESS , Pincés à iris	86
DRYSDALE , Crochets manipulateurs à cristallin	159	HESS-GILL , Pincés à iris	88
E		HIRSCHMANN , Crochets à iris	157
Ecarteurs à orbite	171	HIRSCHMANN , IOL Spatules pour manipuler	187
Ecarteurs à sac lacrymal	170	HOFFER , Marqueurs pour centre optique	190
ELLIOT , Manches de Trépan	196	HOPKINS-JOHNS , Clamps Bulldog	77
ELLIOT , Trépans kéroplastie	196	HOPKINS-JOHNS , Pincés à poser	77
ELLIS , Ciseaux-Burins à corps étrangers	177	I	
ELSCHNIG , Pincés à fixer	90	Instruments pour mesurer	143
ERHARDT , Pincés à entropion	95	Instruments pour vitrectomie	182, 183
Erisiphaque capsulaire	202	J	
Extracteur de cortex	200	JACOBSON , Micro-porte-aiguilles	131
Extractor irrigatrices et pour aspiration	199	JACOBSON , Micro-porte-aiguilles à mors en carbure de tungstène	128
F		JAEGER , Plaque à paupières	170
FAULKNER , Pincés à tenir de cristallin	97	JAFFE , Ecarteurs à sac lacrymal	170
FINO-BARRAQUER , Spatules pour cyclodialyse	188	JAFFE , Spatules pour manipuler	187
FISCHER-ARLT , Pincés à iris	85	JAFFE-BECHERT , Crochets pour tourner	158
FLIERINGA , Anneaux de fixation	195	JAFFE-KNOLLE , Crochets à iris	156
FOERSTER , Pincés à iris	86	JAFFE-MALTZMANN , Crochets manipulateurs à cristallin	161
Fraises pour enlever la rouille	195	JAMESON , Crochets musculaires	154
FRANCESCHETTI , Trépans kéroplastie	195	JAMESON , Pied à coulisse	143
FRANCIS , Ciseaux-Burins à corps étrangers	177	JAMESON , Pincés musculaires	94
FRAZIER , Crochets très fins	147	JAPAN-TOHOKU , Pincés à champs	80
stène	126	Jauge de profondeur	194
FRIEDBURG , Canules irrigatrices et pour aspiration	199	JENSEN , Canules gratteuses	202
FRIEDMAN , Pince-gouges	151	JOHNS-HOPKINS , Clamps Bulldog	77
FUCHS-GILL , Pincés à iris	88	JOHNS-HOPKINS , Pincés à poser	77
G		JONES , Pincés à compresses	79
GASS , Crochets de décollement de la rétine	154	K	
GASS , Marqueur scléral	172	KALT , Micro-porte-aiguilles	132
GILL , Kératomes	173	KALT , Micro-porte-aiguilles à mors en carbure de tungstène	128
GILL , Pincés à iris	88	KALT-ARRUGA , Micro-porte-aiguilles	132
GILL-FUCHS , Pincés à iris	88	KALT-CASTROVIEJO , Micro-porte-aiguilles	132
GILL-HESS , Pincés à iris	88	KATZIN , Ciseaux corneales	110
GILLIES , Crochets très fins	147	KATZIN-BARRAQUER (COLIBRI) , Pincés à iris	87, 88
GILLS-WELSH , Ciseaux pour capsulotomie	109	KATZIN-BARRAQUER , Ciseaux corneales	111
GILLS-WELSH , Extracteur de cortex	200	KELMAN , Canules cystotomes	203
GOLF-CLUB , Ciseaux-Burins à corps étrangers	177	KELMAN , Canules pour cyclodialyse	203
GONNIN , Marqueurs	192	KELMAN-McPHERSON , Pincés pour sutures	92
Gouges	155	Kératomes	173
Gouges à corps étrangers	176-178	Kératomètres	193
GRADLE , Pincés à épiler les cils	83	KERRISON , Pince pour sinus sphénoïdal	155

	Page		Page
KILNER , Crochets très fins	147	MOD. HAMBURG , Couteaux lanceolaires	175
KIRBY , Pincés à iris	87	MOD. TÜBINGEN , Pincés pour sutures	92
KLEINERT-KUTZ , Crochets très fins	147	MOD. BONN , Ciseaux fins	101
KNAPP , Crochets très fins	155	N, Pincés pour sutures	92
KNAPP , Cuillers à transférer la cornée	185	MOD. TÜBINGEN-VANNAS , Pincés ciseaux pour le cataracte secondaire	108
KNOLLE , Canules gratteuses	202	MOLDESTAD , Crochets très fins	149
KNOLLE , Crochets à iris	156	MOORFIELD , Pincés pour suture	90
KNOLLE , Spatules pour cyclodialyse	187	MOSQUITO-HALSTED , Pincés hémostatiques	78
KNOLLE-JAFFE , Crochets à iris	156	MULDOON , Dilatateurs pour le canal lacrymal	164
KNOLLE-PEARCE , Anses à cristallin avec irrigation	201	N	
KRATZ , Canules cystotomes	203	NAGAHARA , Lames à phaco	159
KRATZ , Canules gratteuses	202	NERVE , Micro Ciseaux	116
KRATZ-BARRAQUER , Blépharostats	166	NEW ORLEANS , Anses à cataracte	186
KUHNT , Grattoirs cornées	173	NOYES , Ciseaux à iridectomie	106
KUTZ-KLEINERT , Crochets très fins	147	NOYES , Micro Ciseaux	112
L		O	
LA GRANGE , Ciseaux oculaires	104	OB , Aiguilles ophtalmiques	204
Lames de bistouris	122, 123	OBSTBAUM , Spatules pour manipuler	187
Lames de rasoir	124	O'CONNOR, Crochets très fins	154
LAMPERT , Pincés à chalazion	96	OG , Aiguilles ophtalmiques	204
LANCASTER , Blépharostats	168	Ophtalmoscope	144
LASIK , Manipulateur pour reposition du volet	171	OSHER , Crochets manipulateurs à cristallin	158
LESTER , Crochets manipulateurs à cristallin	161	P	
LESTER , Pincés à fixer	90	PARK-MAUMENEE , Blépharostats	167
LESTER-BURCH , Blépharostats	168	PARTSCH , Ciseau-burins	151
LEWICKY , Crochets manipulateurs à cristallin	160	PARTSCH , Marteau	151
LEWIS , Anses à cataracte	186	PATON , Micro-porte-aiguilles	132
LIEBERMAN , Blépharostats	169	PAUFIQUE , Couteaux pour kératoplastie	175
LINDSTROM , Marqueurs pour kéroplastie	191	PAUFIQUE , Pincés pour sutures	93
LIPPMAN , Spatules pour cyclodialyse	187	PEARCE-KNOLLE , Anses à cristallin avec irrigation	201
LITTAUER , Pincés à épiler les cils	83	PEERS , Pincés à champs	80
LORNA , Pincés à compresses	80	PHAKO-BARRAQUER , Blépharostats	166
LU , Marqueurs pour kéroplastie Lasik	191	Pinceau	205
LUER , Pince-gouges	151	Pincés à chalazion	95, 96
M		Pincés à champs	79, 80
MALONEY , Kératomètres	193	Pincés à compresses	79, 80
MALTMANN-JAFFE , Crochets manipulateurs à cristallin	161	Pincés à dissection	82
Manches pour bistouris	121, 122	Pincés à entropion	95
Marqueurs	190-192	Pincés à épiler les cils	83
Marqueurs à sutures	192	Pincés à fixer	89, 90
Marqueurs axiales	190	Pincés à griffes	82
Marqueurs cornées	191	Pincés à iris	84-88
Marqueurs pour centre optique	190	Pincés à ligature avec plate-forme	93
Marqueurs pour incision limbique	192	Pincés à poser	77
Marqueurs pour kéroplastie	192	Pincés à tenir de cristallins	97
Marqueurs radiales	190	Pincés capsulaires	88, 89
Marteau	151	Pincés capsulorhexis	97
MARTIN , Trépans kéroplastie	195	Pincés ciseaux pour le cataracte secondaire	108, 109
MAUMENEE-PARK , Blépharostats	167	Pincés hémostatiques	78
McDONALD, Pincés capsulorhexis	97	Pincés musculaires	94, 95
McINTYRE, Canules à chambre antérieure	199	Pincés ostéotomes	154
McINTYRE, Canules irrigatrice	198	Pincés pour Bi-Coagulation	209
McPHERSON, Pincés à ligature avec plate-forme	91	Pincés pour la chambre antérieure	91
McPHERSON-KELMAN, Pincés pour sutures	92	Pincés pour sinus sphénoïdal	155
MENDEZ , Instruments pour mesurer degré	194	Pincés pour sutures	90-93
MEYHOEFER , Cuillers à chalazion	185	Pincés-gouges	151
Micro Ciseaux	112-118	Pincettes pour casser les lames	124
Micro Ciseaux, Adventitia	114, 116	Pique de fixation	155
Micro Ciseaux, Dissection	114, 116	Plaqué à paupières	170
Micro Ciseaux, Nerve	116	PLEY , Blépharostats	168
MICRO-ADSON , Pincés à dissection	82	Porte-aiguilles à mors en carbure de tungstène	127, 128
MICRO-ADSON , Pincés à griffes	82	POTTS-SMITH , Micro-porte-aiguilles	132
Micro-porte-aiguilles	128-133	POTTS-SMITH , Micro-porte-aiguilles à mors en carbure de tungstène	128
Micro-porte-aiguilles à manches rondes	128, 129, 130, 133	PRINCE , Pincés musculaires	94
Micro-porte-aiguilles à mors en carbure de tungstène	127, 128	Protecteur	171
Micro-porte-aiguilles à mors en carbure de tungstène	127, 128	R	
MOD. BONN , Canules irrigatrice	198	Rabot à callosité manche	196
MOD. BONN , Pincés à iris	86, 87		
MOD. DORTMUND , Spatules à phaco	187		

	Page		Page
REILL , Micro-porte-aiguilles à manches rondes	130	VANNAS MOD. TÜBINGEN , Pincés ciseaux pour le cataracte secondaire	108
RENTSCH , Crochets manipulateurs à cristallin	161	VANNAS , Pincés ciseaux pour le cataracte secondaire	108
RIBBON , Ciseaux oculaires	105		
ROEDER , Pincés à compresses	79	W	
ROLLET , Crochets très fins	155	WECKER , Ciseaux à iridectomie	106
ROSEN , Crochets à phaco	159	WECKER , Spatules à iris	189
RUEDEMANN , Dilatateurs pour le canal lacrymal	164	WELLS , Cuillers à énucléation	184
RYDER/FRENCH-EYE , Porte-aiguilles à mors en carbure de tungstène	126	WELSH , Extracteur de cortex	200
S		WELSH-GILLS , Ciseaux pour capsulotomie	109
SATO , Kératomes	173	WELSH-GILLS , Extracteur de cortex	200
SATTLER , Pincés musculaires	94	WEST , Gouge	155
SAUER , Blépharostats	168	WESTCOTT , Ciseaux à ténotomie	109
SAUTTER , Canules à injection d'air	199	WESTCOTT , Micro Ciseaux	112
SAUTTER , Spatules à orbite	171	WHEELER , Couteaux à discision	173
SCHAEDEL , Pincés à compresses	79	WILDER , Dilatateurs pour le canal lacrymal	164
SCHEPENS , Dépresseurs	172	WILLIAMS , Blépharostats	166
SCHEPENS , Ecarteurs à orbite	171	WILMER , Ciseaux oculaires	103
SCHIOETZ , Tonomètres	193	WORST , Sondes spiralée	165
SCHOCKET , Dépresseurs	172	Z	
SCHOTT , Blépharostats	167	ZIEGLER , Couteaux à discision	173
Sets	55-64	ZIEGLER , Pincés à épiler les cils	83
SIMCOE , Canules irrigatrices et pour aspiration	199		
SIMCOE , Canules manipulation du noyau	201		
SIMCOE , Extracteur de cortex	200		
SINSKEY , Crochets manipulateurs à cristallin	160		
SMITH-POTTS , Micro-porte-aiguilles	132		
SMITH-POTTS , Micro-porte-aiguilles à mors en carbure de tungstène	128		
SNELLEN , Anses à cataracte	186		
SNELLEN , Pincés à entropion	95		
Sondes exploratrices pour le canal lacrymal	163		
Sondes spiralée	165		
Sondes trabéculaires	165		
Spatules à iris	189		
Spatules à orbite	171		
Spatules pour cyclodialyse	188		
Spatules pour manipuler	187		
Spatules pour noyau	187		
Spéculums naseaux	155		
SPENCER , Ciseaux à ligatures	106		
ST. MARTIN , Pincés pour sutures	91		
STEVENS , Ciseaux à ténotomie	104		
STEVENS , Crochets pour tenotomie	155		
STEVENS , Micro-porte-aiguilles	132		
STEVENS , Pincés à iris	85		
STEVENSON , Ecarteurs à sac lacrymal	170		
STILLE , Instrument à corps étrangers	178		
STORZ , Rabot à callosité manche	196		
T			
TERSON , Pincés capsulaires	88		
THORNTON , Anneaux de fixation	194		
THORNTON , Marqueurs pour incision limbique	192		
THORNTON , Marqueurs pour kéroplastie	192		
TOHOKU-JAPAN , Pincés à champs	80		
Tonomètres	193		
TOOK , Kératomes	173		
Trépans kéroplastie	195, 196		
TROUTMAN (CORNEAL) , Pincés à iris	88		
TROUTMAN , Canules à injection Alpha-Chimo-Trypsine	203		
TROUTMAN , Ciseaux corneales	110		
TROUTMAN , Micro-porte-aiguilles à manches rondes	130		
TROUTMAN-BARRAQUER , Micro-porte-aiguilles à manches rondes	129		
TROUTMAN-CHRIS , Pincettes pour casser les lames	124		
TÜBINGEN MOD. VANNAS , Pincés ciseaux pour cataracte secondaire	108		
TÜBINGEN , Pincés pour sutures	92		
TYRELL , Crochets à iris	157		
V			

Indice alfabetico

	Pagina		Pagina
A			
ADSON, MICRO Pinze anatomiche per dissezione	82	BROWN-ADSON , Pinze chirurgiche a denti di topo	82
ADSON, MICRO Pinze chirurgiche a denti di topo	82	BUNGE , Cucchiai da enucleazione	184
ADSON , Pinze anatomiche per dissezione	82	BUNNKATU , Uncinetti per posizionare cristallino	159
ADSON , Pinze chirurgiche a denti di topo	82	BURCH , Uncinetti per fissazione	155
ADSON-BROWN , Pinze chirurgiche a denti di topo	82	BURCH-LESTER , Blefarostati	168
ADVENTITIA , Micro forbici	114-116	C	
Aghi oftalmichi	204	Calamita per occhi con ansa per corpi estranei	178
Aghi per corpi estranei	176-178	Cannula per lavaggio	201
AGRICOLA , Divaricatori per sacco lacrimale	170	Cannule per iniettare area	199
ANEL , Cannule per vie lacrimali	200	Cannule d'irrigazione	198
Anelli di fissazione	194, 195	Cannule d'irrigazione e d'aspirazione	199
ANIS , Marcatori per sutura	192	Cannule d'irrigazione per camera anteriore	198
ANIS , Marcatori radiali	190	Cannule per alfa-chimotripsina	203
Anse per cataratta	186	Cannule per camera anteriore	199
Anse per cristallino	185	Cannule per ciclodialisi	203
Anse per cristallino con irrigazione	201	Cannule per cistotomi	203
ARLT , Anse per cataratta	186	Cannule per vie lacrimali	200
ARLT-FISCHER , Pinze per iride	85	CASTROVIEJO , Blefarostati	167
ARRUGA , Micro-portaghi	132	CASTROVIEJO , Compasso	143
ARRUGA , Pinze capsulari	89	cchiai corneali	185
ARRUGA , Protettore	171	CASTROVIEJO , Dilatatori per canale lacrimale	165
ARRUGA-KALT , Micro-portaghi	132	CASTROVIEJO , Forbici per cornea	109, 110
Aspiratore capsulare	202	CASTROVIEJO , Forbici per iridectomia	107
AYER , Pinze per calazio	95	CASTROVIEJO , Micro-portaghi	131
B			
BACKHAUS , Pinze per fissare le compresse	79	CASTROVIEJO , Micro-portaghi con manici rotondi	133
BARKAN , Coltelli per goniotomia	174	CASTROVIEJO , Micro-portaghi, carburo di tungsteno	127, 128
BARRAQUER PHAKO , Blefarostati	166	CASTROVIEJO , Pinze capsulari	88
BARRAQUER , Blefarostati	166	CASTROVIEJO , Pinze fissatrici	90
BARRAQUER , Forbici per iridectomia	107	CASTROVIEJO , Pinze per sutura	91
BARRAQUER , Micro-portaghi con manici rotondi	129	CASTROVIEJO , Spatole per ciclodialisi	188
BARRAQUER , Pinze depilatorie	83	CASTROVIEJO , Trepani corneali	195
BARRAQUER , Pinze per la camera anteriore	91	CASTROVIEJO-BARRAQUER , Spatole per ciclodialisi	188
BARRAQUER-CASTROVIEJO , Spatole per ciclodialisi	188	CASTROVIEJO-KALT , Mico-portaghi	132
BARRAQUER-COLIBRI , Blefarostati	166	Cavi da connessione	209
BARRAQUER-FINO , Spatole per ciclodialisi	188	CHADWICK , Forbici oftalmologici	104
BARRAQUER-KATZIN (COLIBRI) , Pinze per iride	87, 88	Cheratometro	193
BARRAQUER-KATZIN , Forbici per cornea	111	CHRIS-TROUTMAN , Pinze per rompere la lamette	124
BARRAQUER-KRATZ , Blefarostati	166	Cistotomi	175
BARRAQUER-TROUTMAN , Micro-portaghi con manici rotondi	129	CITELLI , Pinze osteotomi	154
BECHERT , Uncinetti per rotazione di nucleo cristallino	158	CLAYMAN , Uncinetti per rotazione di nucleo cristallino	158
BECHERT-JAFFE , Uncinetti per rotazione di nucleo cristallino	158	COLIBRI-BARRAQUER , Blefarostati	166
BEER , Pinze depilatorie	83	COLLIN , Manici per bisturi	121
BELL , Aspiratore capsulare	202	Coltelli di diamanti	180-181
Benda di protezione per gli occhi	205	Coltelli lanceolari	175
BERENS , Pinze muscolari	95	Coltelli per cheratoplastica	175
BERKE , Pinze per calazio	96	Coltelli per cornea	173
BINKHORST , Pinze capsulari	89	Coltelli per cataratta	174
BISHOP-HARMON , Cannule d'irrigazione per camera anteriore	198	Coltelli per discissione	173
BISHOP-HARMON , Pinze per iride	87	Coltelli per goniotomia	174
BLASCOVICS , Pinze muscolari	94	Coltelli sclerali	174
Blefarostati	166-169	Compassi	143
BÖHLER , Pinze-sgorbie	151	Contenitore e accessori	46
BONACCOLTO , Pinze per sutura	92	COOK , Blefarostati	168
BONN , Anelli di fissazione	194	CORCELLE , Blefarostati	166
BONN , Cannule d'irrigazione	198	Cucchiai per calazio	185, 186
BONN , Coltelli sclerali	174	Cucchiai per cataratta	185, 186
BONN , Forbici fini	101	Cucchiai per enucleazione	184
BONN , Pinze per iride	86, 87	CULLER , Spatole per l'iride	189
BONN , Pinze per sutura	92	CUSHING , Divaricatori sottili	149
BONN , Uncinetti per l'iride	156	D	
BORES , Marcatori assiali	190	DAVIEL , Cucchiai per cataratta	186
BOWMAN , Blefarostati	166	DAVIS , Scalpelli per corpi estranei	177
BOWMAN , Sonde esploratrici per canale lacrimale	163	DEITZ , Misuratori di profondità	194
		Depressore	172
		DERF , Portaghi	126

DERF , Portaghi con placche di carburo di tungsteno	126	GUTHRIE , Divaricatori sottili	155
DESMARRES , Divaricatori sottili	155	H	
DESMARRES , Pinze per calazio	95	HALLE-HARTMANN , Specoli nasali	155
DIEFFENBACH , Pinze Bulldog	77	HALSEY , Portaghi	126
DIETHRICH , Micro-portaghi con placche di carburo di tungsteno	128	HALSEY , Portaghi con placche di carburo di tungsteno	126
Dilatatori per canale lacrimale	164, 165	HALSTED-MOSQUITO , Pinze emostatiche	78
DISSECTION , Micro forbici	114, 116	HAMBURG , Coltelli lanceolari	175
Divaricatori orbitale	171	HARMON-BISHOP , Cannule d'irrigazione per camera anteriore	198
Divaricatori per sacco lacrimale	170	HARMON-BISHOP , Pinze per iride	87
Divaricatori sottili	147-150	HARMS , Pinze per legature con piattaforma	93
DIX , Strumenti per corpi estranei	178	HARMS , Sonde trabecolari	165
DORTMUND , Spatole per fako	187	HARTMANN , Pinze emostatiche	78
DOUGLAS , Pinze depilatorie	83	HARTMANN-HALLE , Specoli nasali	155
DRYSDALE , Uncinetti per posizionare cristallino	159	HEBRA , Cucchiari per calazio	186
E		HESS , Pinze per iride	86
Elevatori per palpebre	170	HESS-GILL , Pinze capsulari	88
ELLIOT , Trepani corneali	196	HIRSCHMANN , IOL Spatole per manipolare	187
ELLIS , Scalpelli per corpi estranei	177	HIRSCHMANN , Uncinetti per l'iride	157
ELSCHNIG , Pinze fissatrici	90	HOFFER , Marcatori ottici	190
ERHARDT , Pinze per palpebre (entropio)	95	HOPKINS-JOHNS , Pinze Bulldog	77
Estrattore per capsula	200	HOPKINS-JOHNS , Pinze per posizionare	77
F		I	
FAULKNER , Pinze per tenere il cristallino	97	Irrigatore per lenti intraoculari	201
FINO-BARRAQUER , Spatole per ciclodialisi	188	J	
FISCHER-ARLT , Pinze per iride	85	JACOBSON , Micro-portaghi	131
FLIERINGA , Anelli di fissazione	197	JACOBSON , Micro-portaghi con placche di carburo di tungsteno	128
FOERSTER , Pinze per iride	86	JAEGER , Elevatori per palpebre	170
Forbici fini	101	JAFFE , Blefarostati	170
Forbici oftalmologici	101-105	JAFFE , Spatole per manipolare	187
Forbici per cornea	87-90	JAFFE-BECHERT , Uncinetti per rotazione di nucleo cristallino	158
Forbici per iridectomia	102, 106, 107	JAFFE-KNOLLE , Uncinetti per l'iride	156
Forbici per legatura	106	JAFFE-MALTZMANN , Uncini per posizionare cristallino	161
Forbici per strabismo	103	JAMESON , Calibro micrometrico	143
Forbici per tenotomia	104, 109	JAMESON , Pinze muscolari	94
Forbici per vitrectomia	182	JAMESON , Uncinetti per muscoli	154
FRANCESCHETTI , Trepani corneali	195	JAPAN-TOHOKU , Pinze per fissare le compresse	80
FRANCIS , Scalpelli per corpi estranei	177	JENSEN , Levigatore corneale	202
FRAZIER , Divaricatori sottili	147	JOHNS-HOPKINS , Pinze bulldog	77
FRENCH-EYE/Ryder , Portaghi con placche di carburo di tungsteno	126	JOHNS-HOPKINS , Pinze per posizionare	77
Fresa corneale	197	JONES , Pinze per fissare le compresse	79
FRIEDBURG , Cannule d'irrigazione e d'aspirazione	199	K	
FRIEDMAN , Pinze-sgorbie	151	KALT , Micro-portaghi	132
FUCHS-GILL , Pinze capsulari	88	KALT , Micro-portaghi con placche di carburo di tungsteno	128
G		KALT-ARRUGA , Micro-portaghi	132
GASS , Marcadori sclerali	172	KALT-CASTROVIEJO , Mico-portaghi	132
GASS , Uncinetti corneali	154	KATZIN , Forbici per cornea	110
GILL , Coltelli per cornea	173	KATZIN-BARRAQUER (COLIBRI) , Pinze per iride	87, 88
GILL , Pinze capsulari	88	KATZIN-BARRAQUER , Forbici per cornea	111
GILL-FUCHS , Pinze capsulari	88	KELMAN , Cannule per ciclodialisi	203
GILL-HESS , Pinze capsulari	88	KELMAN , Cannule per cistotomi	203
GILLIES , Divaricatori sottili	147	KELMAN-McPHERSON , Pinze per sutura	92
GILLS-WELSH , Estrattore per capsula	200	KERRISON , Pinze per seno sfenoidale	155
GILLS-WELSH , Pinze-forbici per cataratta secondaria	109	KILNER , Divaricatori sottili	147
GOLF-CLUB , Scalpelli per corpi estranei	177	KIRBY , Pinze per iride	87
GONNIN , Marcatori ottici Amsler	192	KLEINERT-KUTZ , Divaricatori sottili	147
GRADLE , Pinze depilatorie	83	KNAPP , Anse per trasferire la cornea	185
GRAEFE , Cistotomi	175	KNAPP , Divaricatori sottili	155
GRAEFE , Coltelli per cataratta	174	KNOLLE , Levigatore corneale	202
GRAEFE , Cucchiari per cataratta	186	KNOLLE , Spatole per nucleo cristallino	187
GRAEFE , Divaricatori sottili	154	KNOLLE , Uncinetti per l'iride	156
GRAEFE , Forbici oftalmologici	103	KNOLLE-JAFFE , Uncinetti per l'iride	156
GRAEFE , Pinze fissatrici	89	KNOLLE-PEARCE , Anse per cristallino con irrigazione	201
GRAEFE , Pinze per iride	84	KRATZ , Cannule per cistotomi	203
GRAEFE , Uncinetti per strabismo	154	KRATZ , Levigatore corneale	202
GRAETHER , Cannule	202	KRATZ-BARRAQUER , Blefarostati	166
GRANDON , Marcatori ottici	190	KUHNT , Raschiatoi corneali	173
GREEN , Pinze fissatrici	89	KUTZ-KLEINERT , Divaricatori sottili	147
GREEN , Uncinetti per muscoli	154	L	
		LA GRANGE , Forbici oftalmologici	104

	Pagina		Pagina
Lame per bisturi	122, 123	O	
Lamette da barba	124	OB , Aghi oftalmichi	204
LAMPERT , Pinze per calazio	96	OBSTBAUM , Spatole per manipolare	187
LANCASTER , Blefarostati	168	O'CONNOR , Divaricatori sottili	154
LASIK , Manipolatore di lamella	171	Oftalmoscopio	144
LESTER , Pinze fissatrici	90	OG , Aghi oftalmichi	204
LESTER , Uncini per posizionare cristallino	161	OSHER , Uncinetti per posizionare cristallino	158
LESTER-BURCH , Blefarostati	168	P	
Levigatore corneale	202	PARK-MAUMENEE , Blefarostati	167
LEWICKY , Uncini per posizionare cristallino	160	PARTSCH , Martelli	151
LEWIS , Anse per cataratta	186	PARTSCH , Scalpelli	151
LIEBERMAN , Blefarostati	169	PATON , Micro-portaghi	132
LINDSTROM , Marcatori corneali	191	PAUFIQUE , Coltelli per cheratoplastica	175
LIPPMAN , Spatole per nucleo cristallino	187	PAUFIQUE , Pinze per sutura	93
LITTAUER , Pinze depilatorie	83	PEARCE-KNOLLE , Anse per cristallino con irrigazione	201
LORNA , Pinze per fissare le compresse	80	PEERS , Pinze per fissare le compresse	80
LU , Marcatori corneali Lasik	191	Pennello	205
LUER , Pinze-sgorbie	151	PHAKO BARRAQUER , Blefarostati	166
M	46	Pinze anatomiche per dissezione	82
MALONEY , Cheratometro	193	Pinze Bulldog	77
MALTZMANN-JAFFE , Uncini per posizionare cristallino	161	Pinze capsulari	88, 89
Manici per bisturi	121, 122	Pinze capsulorhexis	97
Marcadori sclerali	172	Pinze chirurgiche a denti di topo	82
Marcatori	190-192	Pinze depilatorie	83
Marcatori assiali	190	Pinze emostatiche	78
Marcatori corneali	191, 192	Pinze fissatrici	89, 99
Marcatori ottici	190	Pinze muscolari	94, 95
Marcatori per incisione	190	Pinze osteotomi	154
Marcatori per incisione in limbo	192	Pinze per calazio	95, 96
Marcatori per sutura	190, 192	Pinze per fissare le compresse (Fissarele)	79, 80
Marcatori radiali	190	Pinze per iride	84-88
Martelli	151	Pinze per la Bi-Coagulazione	209
MARTIN , Trepani corneali	195	Pinze per la camera anteriore	91
MAUMENEE-PARK , Blefarostati	167	Pinze per ligature con piattaforma	93
McDONALD, Pinze capsulorhexis	97	Pinze per palpebre (entropio)	95
McINTYRE, Cannule d'irrigazione	198	Pinze per posizionare	77
McPHERSON, Pinze per ligature	91	Pinze per rompere la lamette	124
McPHERSON-KELMAN, Pinze per sutura	92	Pinze per seno sfenoidale	155
MENDEZ , Strumenti per misurare	194	Pinze per sutura	90-93
MEYHOEFER , Cucchiari per calazio	185	Pinze per tenere il cristallino	97
Micro Forbici	112-118	Pinze per vitrectomia	183
Micro forbici, Adventitia	114, 116	Pinze-forbici per cataratta secondaria	108, 109
Micro forbici, Dissection	114, 116	Pinze-sgorbie	151
Micro forbici, Nerve	116	PLEY , Blefarostati	168
MICRO-ADSON , Pinze anatomiche per dissezione	82	Portaghi con placche di carburo di tungsteno	126-128
MICRO-ADSON , Pinze chirurgiche a denti di topo	82	POTTS-SMITH , Micro-portaghi	132
Micro-portaghi	128-133	POTTS-SMITH , Micro-portaghi con placche di carburo di tungsteno	128
Micro-portaghi con manici rotondi	128, 129, 130, 133	PRINCE , Pinze muscolari	94
Micro-portaghi con placche di carburo di tungsteno	127, 128	R	
Misuratori di profondità	194	Raschiatoi corneali	173
MOD. BONN , Cannule d'irrigazione	198	REILL , Micro-portaghi con manici rotondi	130
MOD. BONN , Forbici fini	101	RENTSCH , Uncini per posizionare cristallino	161
MOD. BONN , Pinze per sutura	92	ROEDER , Pinze per fissare le compresse	79
MOD. DORTMUND , Spatole per fako	187	ROLLET , Divaricatori sottili	155
MOD. HAMBURG , Coltelli lanceolari	175	ROSEN , Uncini per fako	159
MOD. TÜBINGEN , Pinze per sutura	92	RUEDEMANN , Dilatatori per canale lacrimale	164
MOD. TÜBINGEN-VANNAS , Pinze-forbici per cataratta secondaria	108	RYDER/FRENCH-EYE , Portaghi con placche di carburo di tungsteno	126
MOD. BONN , Pinze per iride	86, 41	S	
MOLDESTAD , Divaricatori sottili	149	SATO , Coltelli per cornea	173
MOORFIELD , Pinze per sutura	90	SATTLER , Pinze muscolari	94
MOSQUITO-HALSTED , Pinze emostatiche	78	SAUER , Blefarostati	168
MULDOON , Dilatatori per canale lacrimale	164	SAUTTER , Cannule per iniettare area	199
N		SAUTTER , Spatole per orbita	171
NAGAHARA , Lame Fako Chopper	159	Scalpelli	151
NERVE , Micro forbici	116	Scalpelli per corpi estranei	176-178
NEW ORLEANS , Anse per cataratta	186	SCHAEDEL , Pinze per fissare le compresse	79
NOYES , Forbici per iridectomia	106	SCHEPENS , Depressore	172
NOYES , Micro forbici	112	SCHEPENS , Divaricatori orbitale	171
		SCHIOETZ , Tonometri	193

SCHOCKET , Depressore	172	WELSH , Estrattore per capsula	200
SCHOTT , Blefarostati	167	WELSH-GILLS , Estrattore per capsula	200
Sets	55-64	WELSH-GILLS , Pinze-forbici per cataratta secondaria	109
Sgorbie	155	WEST , Sgorbie	155
Sgorbie per corpi estranei	176	WESTCOTT , Forbici per tenotomia	109
SIMCOE , Anse per cristallino con irrigazione	201	WESTCOTT , Micro forbici	112
SIMCOE , Cannule d'irrigazione e d'aspirazione	199	WHEELER , Coltelli per discissione	173
SIMCOE , Estrattore per capsula	200	WILDER , Dilatatori per canale lacrimale	164
SINSKEY , Uncini per posizionare cristallino	160	WILLIAMS , Blefarostati	166
Small Set Container	218-220	WILMER , Forbici oftalmologici	103
SMITH-POTTS , Micro-portaghi	132	WORST , Sonde a pigtail	165
SMITH-POTTS , Micro-portaghi con placche di carburo di tungsteno	128	Z	
SNELLEN , Anse per cataratta	186	ZIEGLER , Coltelli per discissione	173
SNELLEN , Pinze per palpebre (entropio)	95	ZIEGLER , Pinze depilatorie	83
Sonde a pigtail	165		
Sonde esploratrici per canale lacrimale	163		
Sonde trabecolari	165		
Spatole per ciclodialisi	188		
Spatole per fako	187		
Spatole per l'iride	189		
Spatole per manipolare	187		
Spatole per nucleo cristallino	187		
Spatole per orbita	171		
Specoli nasali	155		
SPENCER , Forbici per legatura	106		
ST. MARTIN , Pinze per sutura	91		
STEVENS , Forbici per tenotomia	104		
STEVENS , Micro-portaghi	132		
STEVENS , Pinze per iride	85		
STEVENS , Uncinetti de tendini	155		
STEVENSON , Divaricatori per sacco lacrimale	170		
STILLE , Strumenti per corpi estranei	178		
STORZ , Trepani corneali	196		
Strumenti per misurare	143, 194		
Strumenti per misurazione	194		
Strumenti per vitrectomia	182, 183		
T			
TERSON , Pinze capsulari	88		
THORNTON , Anelli di fissazione	194		
THORNTON , Marcatori corneali	192		
THORNTON , Marcatori incisione in limbo	192		
TOHOKU-JAPAN , Pinze per fissare le compresse	80		
Tonometri	193		
TOOK , Coltelli per cornea	173		
Trepani corneali	195, 196		
TROUTMAN (CORNEAL) , Pinze per iride	88		
TROUTMAN , Cannule per Alpha-Chymotrypsin	203		
TROUTMAN , Forbici per cornea	110		
TROUTMAN , Micro-portaghi con manici rotondi	130		
TROUTMAN-BARRAQUER , Micro-portaghi con manici rotondi	129		
TROUTMAN-CHRIS , Pinze per rompere la lamette	124		
TÜBINGEN , Pinze per sutura	92		
TYRELL , Uncinetti per l'iride	157		
U			
Uncinetti de tendini	155		
Uncinetti per fissazione	155		
Uncinetti per l'iride	156, 157		
Uncinetti per muscoli	154		
Uncinetti per posizionare cristallino	158-161		
Uncinetti per rotazione di nucleo cristallino	158		
Uncinetti per strabismo	154		
Uncini per faco	159		
V			
VANNAS MOD. TÜBINGEN , Pinze-forbici per cataratta secondaria	108		
VANNAS , Pinze-forbici per cataratta secondaria	108		
W			
WECKER , Forbici per iridectomia	106		
WECKER , Spatole per l'iride	189		
WELLS , Cucchiari da enucleazione	184		

nopa[®] instruments

nopa instruments

Medizintechnik GmbH

Weilatten 7-9

D - 78532 Tuttlingen

Tel. +49.7462.9490-0

Fax +49.7462.9490-90

info@nopa.de

www.nopa.de

Herstellung und Verkauf chirurgischer
und endoskopischer Instrumente.

Manufacture and Sales of Surgical
and Endoscopic Instruments.

