allgemeine chirurgie
general surgery
cirugía general
chirurgie générale
chirurgia generale

nopa[®] instruments





Dies ist unser Hauptkatalog, er bleibt unser ausschließliches Eigentum. Es gelten unsere allgemeinen Lieferbedingungen. Sie finden diese auf unserer Internetseite: www.nopa-instruments.com.

This is our General Catalogue. It remains our exclusive property. Please find our "General Terms of Sale" on our corporate website: www.nopa-instruments.com.

Esto es nuestro catálogo y queda nuestra propiedad. Nuestros condiciones generales de venta se encuentran en nuestra página web: www.nopa-instruments.com.

Voilà notre catalogue et il demeure notre propriété. Veuillez consulter nos conditions générales de vente sur notre page Internet : www.nopa-instruments.com.

Questo è nostro catalogo e rimane nostra proprietà. Trovano applicazione le nostre condizioni generali di fornitura, che sono disponibili sul nostro sito: www.nopa-instruments.com.

Modelländerungen vorbehalten. Nachdruck, auch auszugsweise, verboten.
Change of design and pattern reserved. Re-printing, even in extracts, not permitted.
Nos reservamos el derecho de modificaciones sin aviso previo. Reimpresión, también parcialmente, esta prohibido.
Tous droits réservés aux changements de modèle. Réimprimer, également partiellement, est interdit.
Noi riserviamo il diritto di effettuare delle modificazioni. Ristampa di divieto anche parziale.



confidence in

nopa[®] instruments

more than

35
YEARS

thank you for choosing

nopa[®] instruments

...you obviously have good taste

Bitte fordern Sie unsere
entsprechenden Kataloge an.

Please request for our
appropriate catalogues.

Por favor pidan por nuestros
catálogos apropiados.

Veillez demander nos
catalogues appropriés.

Chieda prego i nostri
cataloghi adatti.

>> Unser Lieferprogramm

Allgemeinchirurgie und Gynäkologie
Plastische Chirurgie und HNO
Cardiovascular
Neurochirurgie
Ophthalmologie
Endoskopie
Behältnisse zur Instrumentensterilisation
Dental und Oral

>> Our product range

General Surgery and Gynecology
Plastic Surgery and ENT
Cardiovascular
Neurosurgery
Ophthalmology
Endoscopy
Sterilizing Containers
Dental and Oral

**>> Nuestro gama
de productos**

Cirugía generales y Ginecología
Cirugía plástica y ORL
Cardiovasculares
Neurocirugía
Oftalmología
Endoscópico
Cajas para esterilización
Odontología y Oral

>> Notre gamme

Chirurgie générale et Gynecologie
Chirurgie plastique et ORL
Cardiovasculaires
Neurochirurgie
Ophtalmologie
Endoscopie
Des boîtes à instruments et pour la stérilisation
Dental et Oral

**>> Nostro programma
di produzione**

Chirurgia generale e Ginecologia
Chirurgia plastica ed ORL
Cardiovascolari
Neurochirurgia
Oftalmologia
Endoscopia
Astucci per la sterilizzazione
Odontoiatria e Orale

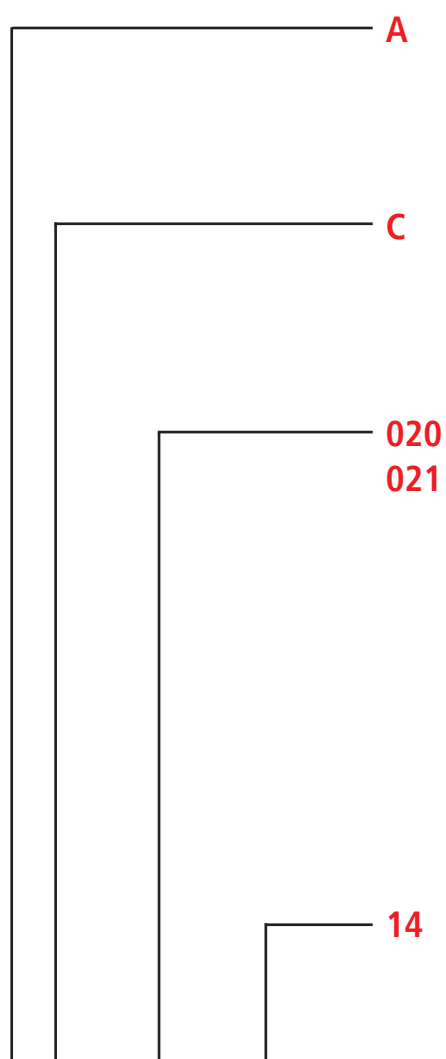

Artikelcode **AC 020/14**

Allgemeines Instrumentarium

General Instruments
Instrumental Général
Instruments Générales
Strumenti generali

Scheren

Scissors
Tijeras
Ciseaux
Forbici

Fortlaufende Nummern

Gerade Ziffer = gerades Instrument
Ungerade Ziffer = gebogenes Instrument

Continuous number

Even number = straight instrument
Odd number = curved instrument

Número de orden

números pares = instrumento derecho
números impares = instrumento curvado

Numéros d'ordre

numéro pair = instrument droit
numéro impair = instrument courbe

Numeri progressivamente

numero pari = strumento retto
numero dispari = strumento curvo

Länge oder Figur

Length or Figure
Longitud o figura
Longueur ou figure
Lunghezza o figura



INDEX

>> Klemmen • Hemostats • Pinzas hemostáticas • Pincas hémostatiques • Pinze emostatiche	7–54	AA
>> Pinzetten • Forceps • Pinzas • Pincas • Pinze	55–98	AB
>> Scheren • Scissors • Tijeras • Ciseaux • Forbici	99–162	AC
>> Skalpelle • Scalpels • Bisturías • Bistouris • Bisturi	163–178	AD
>> Naht • Suture • Sutura • Suture • Sutura	179–226	AE
>> Tupferzangen • Sponge Forceps >> Pinzas para pólipos • Pincas à pansements • Pinze per polipi	227–240	AF
>> Wundhaken • Retractors • Separadores • Ecarteurs • Divaricatori	241–308	AK
>> Sonden • Probes • Sondas • Sondes • Sonde	309–316	AL
>> Verband • Dressing • Vendajes • Pansements • Bendaggi	317–324	AM
>> Punktion/Kanülen • Puncture/Special Needles Punción/Agujas especiales • Ponction/Aiguilles spéciales • Puntura/Aghi speciali	325–340	AO
>> Narkose • Anaesthesia • Anestesia • Anesthésie • Anestesia	351–366	AP
>> Diagnostik • Diagnostics • Diagnóstico • Diagnostic • Diagnostica	367–384	AR
>> Orthopädie • Orthopaedic • Ortopedia • Orthopédie • Ortopedia	385–516	KA
>> Darm/Magen/Mastdarm • Intestines/Stomach/Rectum • Intestinos/Estómago/Recto Intestins/Estomac/Rectum • Intestini/Stomaco/Retto	515–554	KD
>> Verschiedenes • Various items • Diversos Articulos Articles divers • Articoli diversi		
>> Fußpflege • Podiatry • Pedicura • Soins des Pieds • Pedicure	555–580	KU
>> Reinigungsbürsten • Cleaning brushes • Cepillos de limpieza Brosses pour nettoyer • Spazzoli per pulire	581–592	KY



KLEMMEN
HEMOSTATS
PINZAS HEMOSTATICAS
PINCES HEMOSTATIQUES
PINZE EMOSTATICHE

AA

nopa[®] instruments



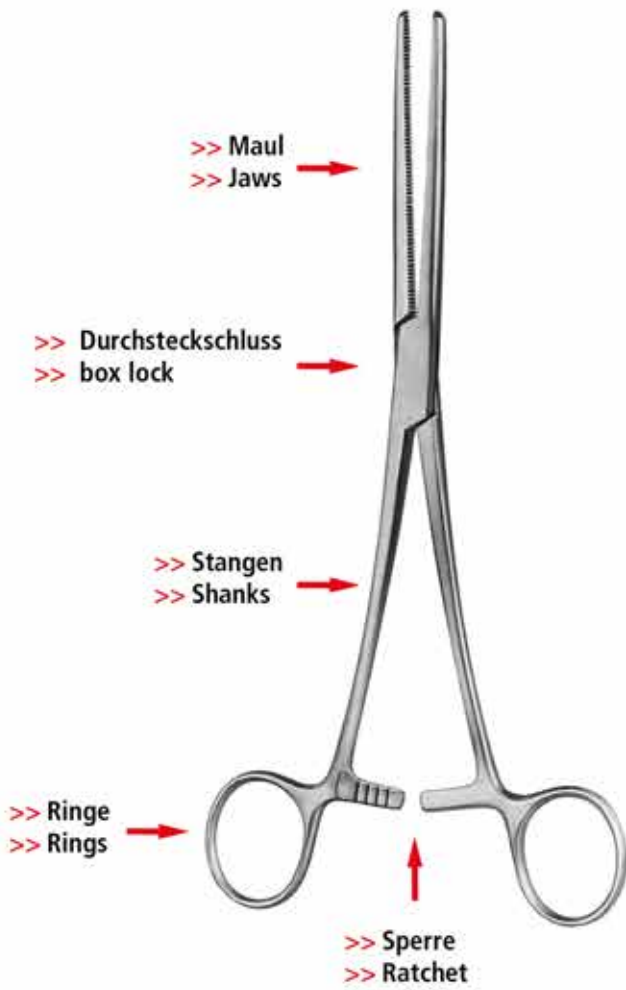

>> Spitzen
>> Tips



>> ohne Zähne
>> without teeth



>> mit Zähnen 1:2
>> with teeth 1:2

>> Maulbiegung
>> jaw curvature

>> Riefung
>> serrations

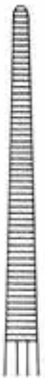

>> gerade
>> straight



>> gebogen
>> curved



>> quer
>> horizontal



>> längs
>> longitudinal



>> kreuz
>> cross

Gewebefasszangchen, Darmfasszangen
 Tissue Seizing Forceps
 Pinzas para coger tejidos e intestinos
 Pincers pour saisir le tissu et l'intestin
 Pinze per afferrare tessuti e l'intestino

AA
AB
AC
AD
AE
AF
AK
AL
AM
AO
AP
AR
KA
KD
KU
KY



ALLIS 4:5
KD 054/15
 15,0 cm/6"



ALLIS 5:6
 15,0 cm/6" **KD 055/15**
 19,0 cm/7 1/2" **KD 055/19**
 25,0 cm/10" **KD 055/25**



BABCOCK



KD 111/16
 16,0 cm/6 1/4"



KD 111/18
 18,0 cm/7"



KD 111/20
 20,0 cm/8"



KD 111/24
 24,0 cm/9 1/2"

Bulldogklemmen
Bulldog Clamps
Clamps Bulldog
Clamps Bulldog
Pinze Bulldog

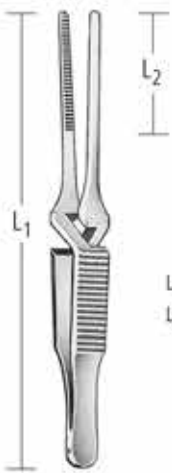

AA 050/01	AA 050/02	AA 050/03	AA 051/01	AA 051/02	AA 051/03
L ₁ 50 mm	50 mm	60 mm	50 mm	50 mm	60 mm
L ₂ 8 mm	12 mm	20 mm	8 mm	12 mm	20 mm

3 gr.	50 gr.
Gewicht	Druck
Weight	Pressure
Peso	Presión
Poids	Pression
Peso	Pressione

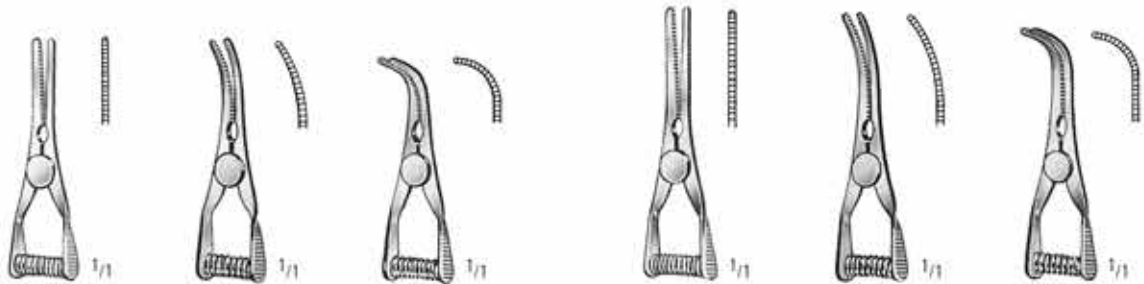

VENA
ARTERIA

AA 052/01	TITAN 30 mm	AA 052/03	AA 054/01	TITAN 35 mm	AA 054/03
AA 053/01	AA 052/02	AA 053/03	AA 055/01	AA 054/02	AA 055/03
	AA 053/02			AA 055/02	

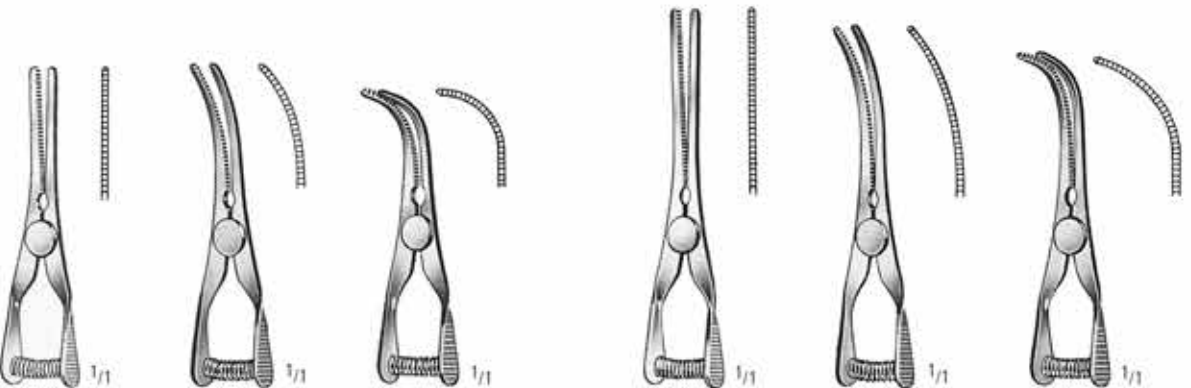

VENA
ARTERIA

AA 056/01	TITAN 40 mm	AA 056/03	AA 058/01	TITAN 50 mm	AA 058/03
AA 057/01	AA 056/02	AA 057/03	AA 059/01	AA 058/02	AA 059/03
	AA 057/02			AA 059/02	

Bulldogklemmen, Anlegezange
 Bulldog Clamps, Setting Forceps
 Clamps Bulldog, Pinza para poner
 Clamps Bulldog, Pince à poser
 Pinze Bulldog, Pinza per posizionare

AA
 AB
 AC
 AD
 AE
 AF
 AG
 AH
 AI
 AJ
 AK
 AL
 AM
 AN
 AO
 AP
 AQ
 AR
 AS
 AT
 AU
 AV
 AW
 AX
 AY
 AZ



DIEFFENBACH

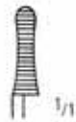

AA 060/03
 3,5 cm/1 1/2"

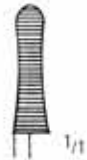

AA 060/05
 5,0 cm/2"

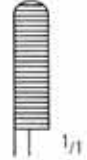

AA 060/06
 6,0 cm/2 1/2"



AA 061/03
 3,5 cm/1 1/2"

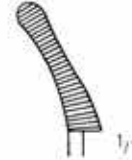

AA 061/05
 5,0 cm/2"



AA 061/06
 6,0 cm/2 1/2"



JOHNS-HOPKINS
AA 069/24
 24,5 cm/9 3/4"



JOHNS-HOPKINS

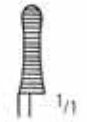

AA 070/04
 4,0 cm/1 1/2"

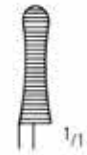

AA 070/05
 5,0 cm/2"

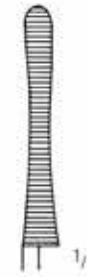

AA 070/06
 6,5 cm/2 1/2"

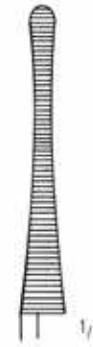

AA 070/07
 7,5 cm/3"

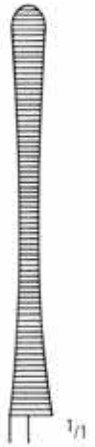

AA 070/09
 9,0 cm/3 1/2"



AA 071/04
 4,0 cm/1 1/2"



AA 071/05
 5,0 cm/2"

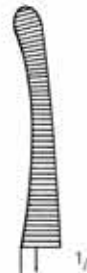

AA 071/06
 6,5 cm/2 1/2"

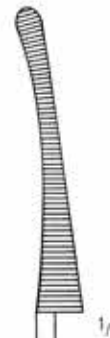

AA 071/07
 7,5 cm/3"

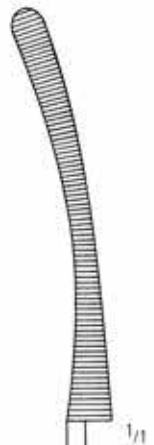

AA 071/09
 9,0 cm/3 1/2"

Fasszangen, Gefäßklemme, Kopfhautklemmen
 Seizing Forceps, Blood Vessel Clamps, Scalp Flap Forceps
 Pinzas para coger, Clamps para vasos, Pinzas hemostáticas para pericráneo
 Pincés à saisir, Pincés vasculaire, Pincés hémostatiques pour le cuir chevelu
 Pinze per afferrare, Pinza per vasi, Pinze emostatiche per il cuoio capelluto



CHAPUT
AA 072/02
 13,0 cm/5"



TUFFIER
AA 072/04
 13,0 cm/5"

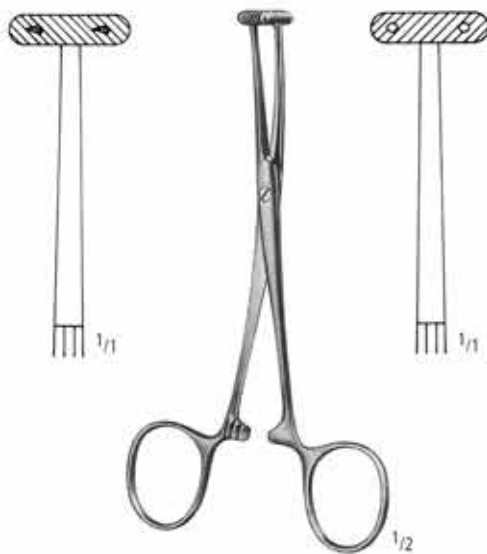

MARTEL
AA 078/14
 14,0 cm/5 1/2"

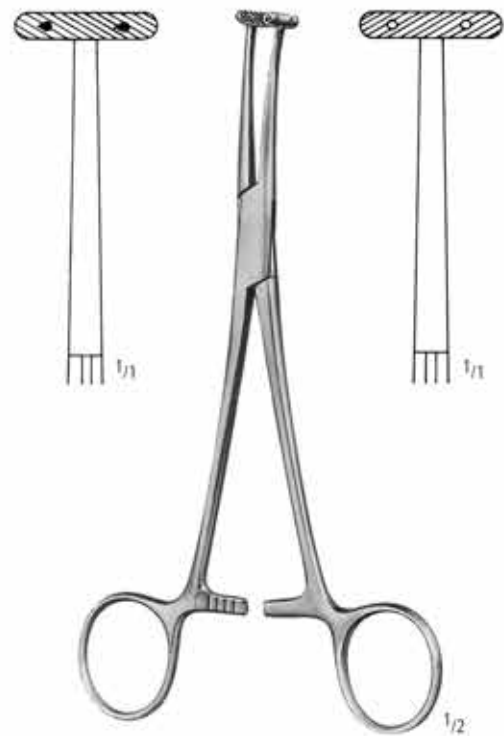

WILLET-MARTEL
AA 078/19
 19,0 cm/7 1/2"

Arterienklemmen, Faszangen
 Artery Forceps, Seizing Forceps
 Pinzas hemostáticas, Pinzas para coger
 Pincés hémostatiques, Pincés à saisir
 Pinze emostatiche, Pinze per afferrare

AA
 AB
 AC
 AD
 AE
 AF
 AG
 AH
 AI
 AJ
 AK
 AL
 AM
 AN
 AO
 AP
 AR
 AS
 AT
 AU
 AV
 AW
 AX
 AY
 AZ



AA 080/14 AA 080/16

PEAN
 14,0 cm/5½"
 16,0 cm/6¼"

AA 080/14
 AA 080/16

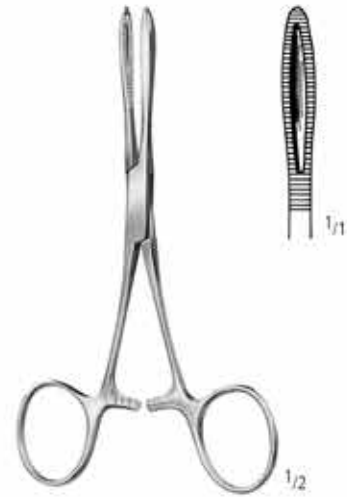

KROENLEIN
 AA 082/13
 13,0 cm/5"



AA 084/15

PENNINGTON
 15,5 cm/6"
 20,0 cm/8"

AA 084/15
 AA 084/20

Arterienklemmen
 Artery Forceps
 Pinzas hemostáticas
 Pincas hémostatiques
 Pinze emostatiche



SPENCER-WELLS

AA 110/13
 13,0 cm/5"

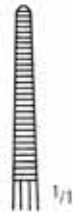

AA 110/14
 14,0 cm/5½"

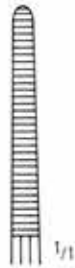

AA 110/15
 15,5 cm/6"

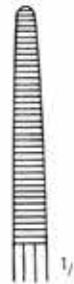

AA 110/18
 18,0 cm/7"

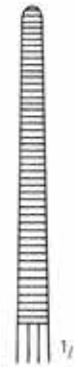

AA 110/20
 20,0 cm/8"

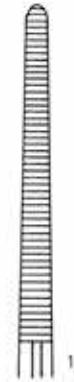

AA 110/36
 36,0 cm/14"

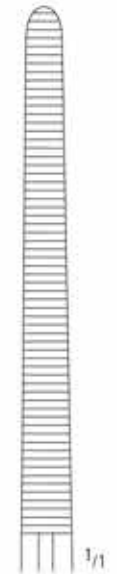

AA 111/13
 13,0 cm/5"



AA 111/14
 14,0 cm/5½"



AA 111/15
 15,5 cm/6"



AA 111/18
 18,0 cm/7"



AA 111/20
 20,0 cm/8"



HARTMANN
AA 114/10
 10,0 cm/4"



HARTMANN
AA 115/10
 10,0 cm/4"



CARREL
AA 116/08
 8,5 cm/3½"

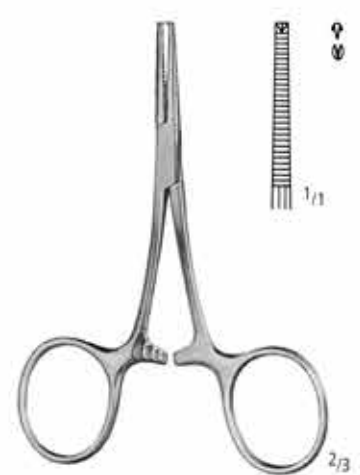

TERRIER 1:2
AA 118/08
 8,5 cm/3½"

Feine Arterienklemmen
 Fine Artery Forceps
 Pinzas hemostáticas finas
 Pincés hémostatiques fines
 Pinze emostatiche fine

AA
 AB
 AC
 AD
 AE
 AF
 AG
 AH
 AI
 AJ
 AK
 AL
 AM
 AN
 AO
 AP
 AQ
 AR
 AS
 AT
 AU
 AV
 AW
 AX
 AY
 AZ
 BA
 BB
 BC
 BD
 BE
 BF
 BG
 BH
 BI
 BJ
 BK
 BL
 BM
 BN
 BO
 BP
 BQ
 BR
 BS
 BT
 BU
 BV
 BW
 BX
 BY
 BZ
 CA
 CB
 CC
 CD
 CE
 CF
 CG
 CH
 CI
 CJ
 CK
 CL
 CM
 CN
 CO
 CP
 CQ
 CR
 CS
 CT
 CU
 CV
 CW
 CX
 CY
 CZ
 DA
 DB
 DC
 DD
 DE
 DF
 DG
 DH
 DI
 DJ
 DK
 DL
 DM
 DN
 DO
 DP
 DQ
 DR
 DS
 DT
 DU
 DV
 DW
 DX
 DY
 DZ
 EA
 EB
 EC
 ED
 EE
 EF
 EG
 EH
 EI
 EJ
 EK
 EL
 EM
 EN
 EO
 EP
 EQ
 ER
 ES
 ET
 EU
 EV
 EW
 EX
 EY
 EZ
 FA
 FB
 FC
 FD
 FE
 FF
 FG
 FH
 FI
 FJ
 FK
 FL
 FM
 FN
 FO
 FP
 FQ
 FR
 FS
 FT
 FU
 FV
 FW
 FX
 FY
 FZ
 GA
 GB
 GC
 GD
 GE
 GF
 GG
 GH
 GI
 GJ
 GK
 GL
 GM
 GN
 GO
 GP
 GQ
 GR
 GS
 GT
 GU
 GV
 GW
 GX
 GY
 GZ
 HA
 HB
 HC
 HD
 HE
 HF
 HG
 HH
 HI
 HJ
 HK
 HL
 HM
 HN
 HO
 HP
 HQ
 HR
 HS
 HT
 HU
 HV
 HW
 HX
 HY
 HZ
 IA
 IB
 IC
 ID
 IE
 IF
 IG
 IH
 II
 IJ
 IK
 IL
 IM
 IN
 IO
 IP
 IQ
 IR
 IS
 IT
 IU
 IV
 IW
 IX
 IY
 IZ
 JA
 JB
 JC
 JD
 JE
 JF
 JG
 JH
 JI
 JJ
 JK
 JL
 JM
 JN
 JO
 JP
 JQ
 JR
 JS
 JT
 JU
 JV
 JW
 JX
 JY
 JZ
 KA
 KB
 KC
 KD
 KE
 KF
 KG
 KH
 KI
 KJ
 KK
 KL
 KM
 KN
 KO
 KP
 KQ
 KR
 KS
 KT
 KU
 KV
 KW
 KX
 KY
 KZ
 LA
 LB
 LC
 LD
 LE
 LF
 LG
 LH
 LI
 LJ
 LK
 LL
 LM
 LN
 LO
 LP
 LQ
 LR
 LS
 LT
 LU
 LV
 LW
 LX
 LY
 LZ
 MA
 MB
 MC
 MD
 ME
 MF
 MG
 MH
 MI
 MJ
 MK
 ML
 MM
 MN
 MO
 MP
 MQ
 MR
 MS
 MT
 MU
 MV
 MW
 MX
 MY
 MZ
 NA
 NB
 NC
 ND
 NE
 NF
 NG
 NH
 NI
 NJ
 NK
 NL
 NM
 NN
 NO
 NP
 NQ
 NR
 NS
 NT
 NU
 NV
 NW
 NX
 NY
 NZ
 OA
 OB
 OC
 OD
 OE
 OF
 OG
 OH
 OI
 OJ
 OK
 OL
 OM
 ON
 OO
 OP
 OQ
 OR
 OS
 OT
 OU
 OV
 OW
 OX
 OY
 OZ
 PA
 PB
 PC
 PD
 PE
 PF
 PG
 PH
 PI
 PJ
 PK
 PL
 PM
 PN
 PO
 PP
 PQ
 PR
 PS
 PT
 PU
 PV
 PW
 PX
 PY
 PZ
 QA
 QB
 QC
 QD
 QE
 QF
 QG
 QH
 QI
 QJ
 QK
 QL
 QM
 QN
 QO
 QP
 QQ
 QR
 QS
 QT
 QU
 QV
 QW
 QX
 QY
 QZ
 RA
 RB
 RC
 RD
 RE
 RF
 RG
 RH
 RI
 RJ
 RK
 RL
 RM
 RN
 RO
 RP
 RQ
 RR
 RS
 RT
 RU
 RV
 RW
 RX
 RY
 RZ
 SA
 SB
 SC
 SD
 SE
 SF
 SG
 SH
 SI
 SJ
 SK
 SL
 SM
 SN
 SO
 SP
 SQ
 SR
 SS
 ST
 SU
 SV
 SW
 SX
 SY
 SZ
 TA
 TB
 TC
 TD
 TE
 TF
 TG
 TH
 TI
 TJ
 TK
 TL
 TM
 TN
 TO
 TP
 TQ
 TR
 TS
 TT
 TU
 TV
 TW
 TX
 TY
 TZ
 UA
 UB
 UC
 UD
 UE
 UF
 UG
 UH
 UI
 UJ
 UK
 UL
 UM
 UN
 UO
 UP
 UQ
 UR
 US
 UT
 UY
 UZ
 VA
 VB
 VC
 VD
 VE
 VF
 VG
 VH
 VI
 VJ
 VK
 VL
 VM
 VN
 VO
 VP
 VQ
 VR
 VS
 VT
 VY
 VZ
 WA
 WB
 WC
 WD
 WE
 WF
 WG
 WH
 WI
 WJ
 WK
 WL
 WM
 WN
 WO
 WP
 WQ
 WR
 WS
 WT
 WY
 WZ
 XA
 XB
 XC
 XD
 XE
 XF
 XG
 XH
 XI
 XJ
 XK
 XL
 XM
 XN
 XO
 XP
 XQ
 XR
 XS
 XT
 XU
 XV
 XW
 XX
 XY
 XZ
 YA
 YB
 YC
 YD
 YE
 YF
 YG
 YH
 YI
 YJ
 YK
 YL
 YM
 YN
 YO
 YP
 YQ
 YR
 YS
 YT
 YZ
 ZA
 ZB
 ZC
 ZD
 ZE
 ZF
 ZG
 ZH
 ZI
 ZJ
 ZK
 ZL
 ZM
 ZN
 ZO
 ZP
 ZQ
 ZR
 ZS
 ZT
 ZY
 ZZ

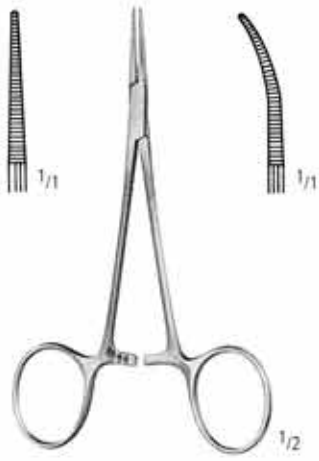

MICRO-MOSQUITO
 AA 130/10 AA 131/10
 AA 130/12 AA 131/12

10,0 cm/4"
 12,0 cm/4³/₄"

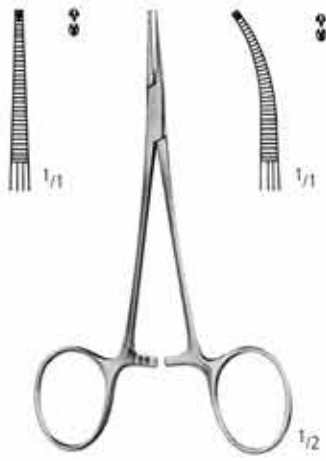

MICRO-MOSQUITO 1:2
 AA 132/10 AA 133/10
 AA 132/12 AA 133/12

WILLIAM STEWART HALSTED
 was professor of surgery in the Johns Hopkins University. In 1890 he had bronze casts made of his own hands. On these casts the first surgical rubber gloves were moulded.



HALSTED-MOSQUITO
 AA 150/12 AA 151/12
 AA 150/14 AA 151/14

12,5 cm/5"
 14,0 cm/5¹/₂"

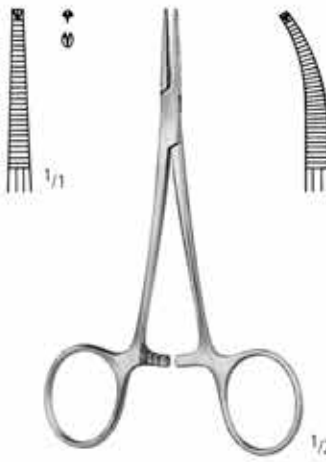

HALSTED-MOSQUITO 1:2
 AA 152/12 AA 153/12
 AA 152/14 AA 153/14

Arterienklemmen
 Artery Forceps
 Pinzas hemostáticas
 Pincas hémostatiques
 Pinze emostatiche

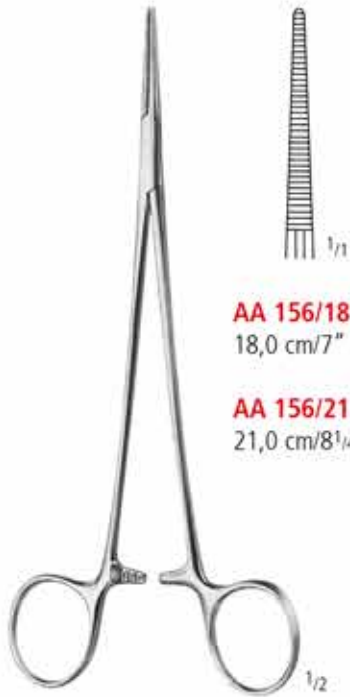

AA 156/18
 18,0 cm/7"

AA 156/21
 21,0 cm/8¹/₄"

HALSTED



AA 157/18
 18,0 cm/7"

AA 157/21
 21,0 cm/8¹/₄"

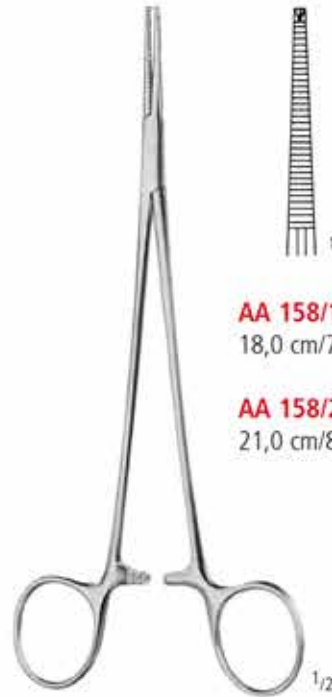

AA 158/18
 18,0 cm/7"

AA 158/21
 21,0 cm/8¹/₄"

HALSTED 1:2

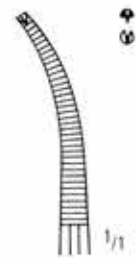

AA 159/18
 18,0 cm/7"

AA 159/21
 21,0 cm/8¹/₄"

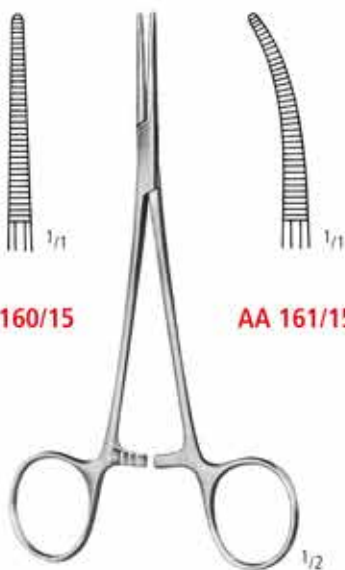

AA 160/15

AA 161/15

LERICHE
 15,0 cm/6"

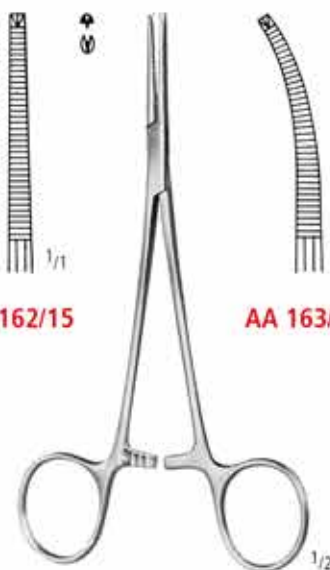

AA 162/15

AA 163/15

LERICHE 1:2
 15,0 cm/6"

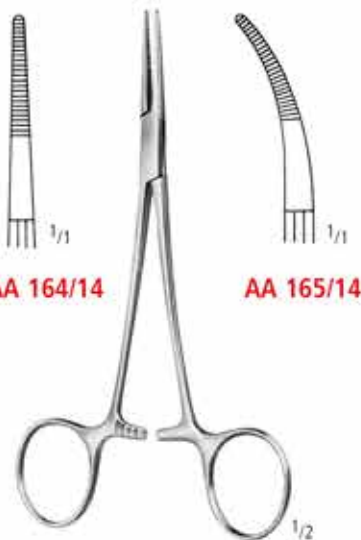

AA 164/14

AA 165/14

PROVIDENCE-HOSPITAL
 14,0 cm/5¹/₂"

Arterienklemmen
Artery Forceps
Pinzas hemostáticas
Pincés hémostatiques
Pinze emostatiche

AA
AB
AC
AD
AE
AF
AG
AH
AI
AJ
AK
AL
AM
AN
AO
AP
AQ
AR
AS
AT
AU
AV
AW
AX
AY
AZ
BA
BB
BC
BD
BE
BF
BG
BH
BI
BJ
BK
BL
BM
BN
BO
BP
BQ
BR
BS
BT
BU
BV
BW
BX
BY
BZ
CA
CB
CC
CD
CE
CF
CG
CH
CI
CJ
CK
CL
CM
CN
CO
CP
CQ
CR
CS
CT
CU
CV
CW
CX
CY
CZ
DA
DB
DC
DD
DE
DF
DG
DH
DI
DJ
DK
DL
DM
DN
DO
DP
DQ
DR
DS
DT
DU
DV
DW
DX
DY
DZ
EA
EB
EC
ED
EE
EF
EG
EH
EI
EJ
EK
EL
EM
EN
EO
EP
EQ
ER
ES
ET
EU
EV
EW
EX
EY
EZ
FA
FB
FC
FD
FE
FF
FG
FH
FI
FJ
FK
FL
FM
FN
FO
FP
FQ
FR
FS
FT
FU
FV
FW
FX
FY
FZ
GA
GB
GC
GD
GE
GF
GG
GH
GI
GJ
GK
GL
GM
GN
GO
GP
GQ
GR
GS
GT
GU
GV
GW
GX
GY
GZ
HA
HB
HC
HD
HE
HF
HG
HH
HI
HJ
HK
HL
HM
HN
HO
HP
HQ
HR
HS
HT
HU
HV
HW
HX
HY
HZ
IA
IB
IC
ID
IE
IF
IG
IH
II
IJ
IK
IL
IM
IN
IO
IP
IQ
IR
IS
IT
IU
IV
IW
IX
IY
IZ
JA
JB
JC
JD
JE
JF
JG
JH
JI
JJ
JK
JL
JM
JN
JO
JP
JQ
JR
JS
JT
JU
JV
JW
JX
JY
JZ
KA
KB
KC
KD
KE
KF
KG
KH
KI
KJ
KK
KL
KM
KN
KO
KP
KQ
KR
KS
KT
KU
KV
KW
KX
KY
KZ
LA
LB
LC
LD
LE
LF
LG
LH
LI
LJ
LK
LL
LM
LN
LO
LP
LQ
LR
LS
LT
LU
LV
LW
LX
LY
LZ
MA
MB
MC
MD
ME
MF
MG
MH
MI
MJ
MK
ML
MM
MN
MO
MP
MQ
MR
MS
MT
MU
MV
MW
MX
MY
MZ
NA
NB
NC
ND
NE
NF
NG
NH
NI
NJ
NK
NL
NM
NN
NO
NP
NQ
NR
NS
NT
NU
NV
NW
NX
NY
NZ
OA
OB
OC
OD
OE
OF
OG
OH
OI
OJ
OK
OL
OM
ON
OO
OP
OQ
OR
OS
OT
OU
OV
OW
OX
OY
OZ
PA
PB
PC
PD
PE
PF
PG
PH
PI
PJ
PK
PL
PM
PN
PO
PP
PQ
PR
PS
PT
PU
PV
PW
PX
PY
PZ
QA
QB
QC
QD
QE
QF
QG
QH
QI
QJ
QK
QL
QM
QN
QO
QP
QQ
QR
QS
QT
QU
QV
QW
QX
QY
QZ
RA
RB
RC
RD
RE
RF
RG
RH
RI
RJ
RK
RL
RM
RN
RO
RP
RQ
RR
RS
RT
RU
RV
RW
RX
RY
RZ
SA
SB
SC
SD
SE
SF
SG
SH
SI
SJ
SK
SL
SM
SN
SO
SP
SQ
SR
SS
ST
SU
SV
SW
SX
SY
SZ
TA
TB
TC
TD
TE
TF
TG
TH
TI
TJ
TK
TL
TM
TN
TO
TP
TQ
TR
TS
TT
TU
TV
TW
TX
TY
TZ
UA
UB
UC
UD
UE
UF
UG
UH
UI
UJ
UK
UL
UM
UN
UO
UP
UQ
UR
US
UT
UU
UV
UW
UX
UY
UZ
VA
VB
VC
VD
VE
VF
VG
VH
VI
VJ
VK
VL
VM
VN
VO
VP
VQ
VR
VS
VT
VU
VV
VW
VX
VY
VZ
WA
WB
WC
WD
WE
WF
WG
WH
WI
WJ
WK
WL
WM
WN
WO
WP
WQ
WR
WS
WT
WU
WV
WW
WX
WY
WZ
XA
XB
XC
XD
XE
XF
XG
XH
XI
XJ
XK
XL
XM
XN
XO
XP
XQ
XR
XS
XT
XU
XV
XW
XX
XY
XZ
YA
YB
YC
YD
YE
YF
YG
YH
YI
YJ
YK
YL
YM
YN
YO
YP
YQ
YR
YS
YT
YU
YV
YW
YX
YY
YZ
ZA
ZB
ZC
ZD
ZE
ZF
ZG
ZH
ZI
ZJ
ZK
ZL
ZM
ZN
ZO
ZP
ZQ
ZR
ZS
ZT
ZU
ZV
ZW
ZX
ZY
ZZ

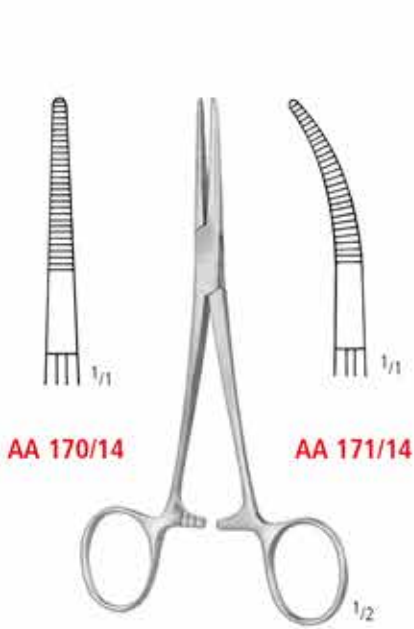

AA 170/14 AA 171/14

KELLY
14,0 cm/5 1/2"

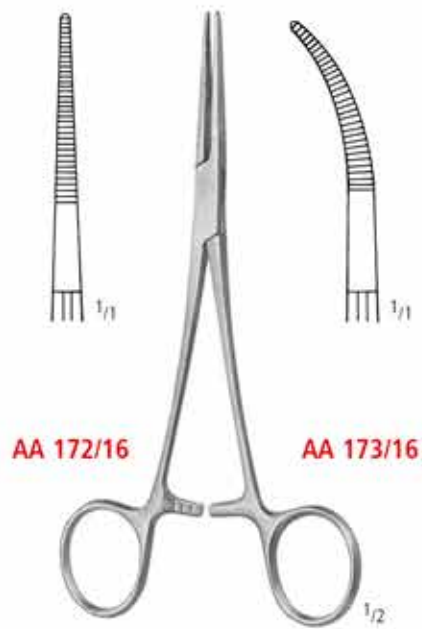

AA 172/16 AA 173/16

KELLY-RANKIN
16,0 cm/6 1/4"

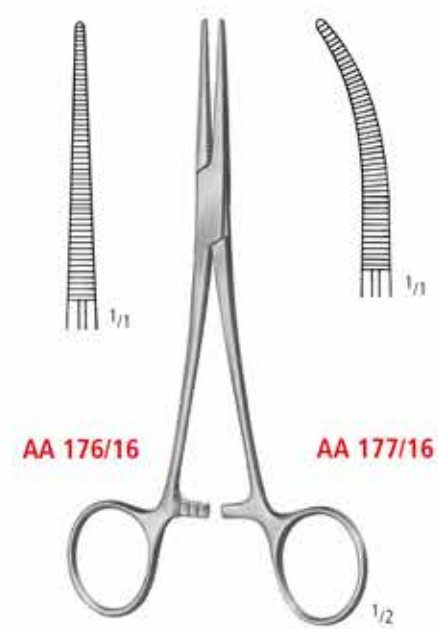

AA 176/16 AA 177/16

COLLER
AA 176/14 14,0 cm/5 1/2" AA 177/14
AA 176/16 16,0 cm/6 1/4" AA 177/16

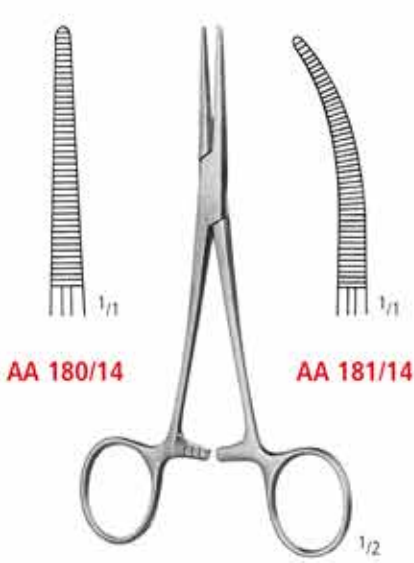

AA 180/14 AA 181/14

CRILE
14,0 cm/5 1/2"

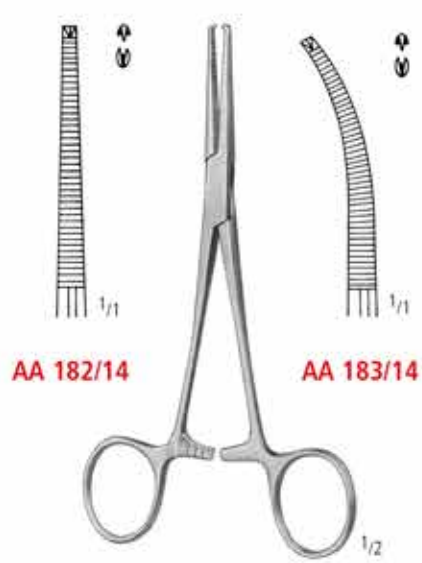

AA 182/14 AA 183/14

CRILE 1:2
14,0 cm/5 1/2"

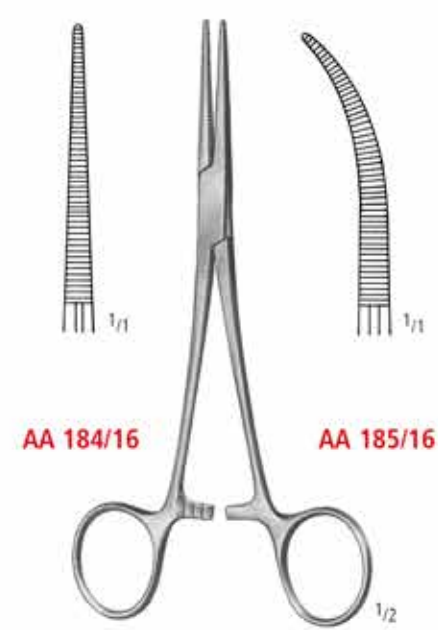

AA 184/16 AA 185/16

CRILE-RANKIN
16,0 cm/6 1/4"

Arterienklemmen
 Artery Forceps
 Pinzas hemostáticas
 Pincas hémostatiques
 Pinze emostatiche



ROCHESTER-PEAN

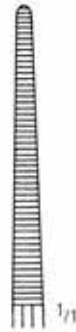

AA 200/14
 14,0 cm/5 1/2"

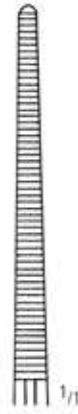

AA 200/16
 16,0 cm/6 1/4"

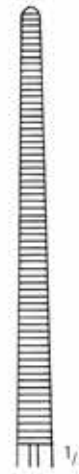

AA 200/18
 18,0 cm/7"

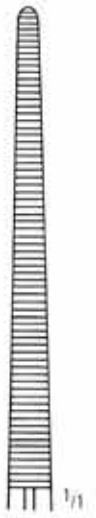

AA 200/20
 20,0 cm/8"

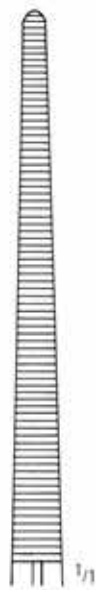

AA 200/22
 22,0 cm/8 3/4"

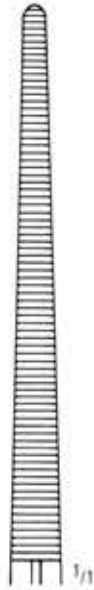

AA 200/24
 24,0 cm/9 1/2"

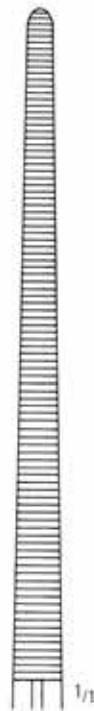

AA 200/26
 26,0 cm/10 1/2"

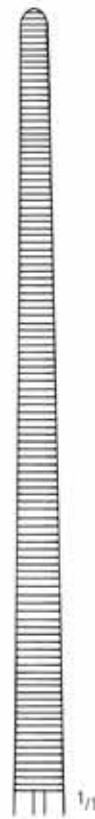

AA 200/30
 30,0 cm/12"



AA 200/36
 36,0 cm/14"

Arterienklemmen
 Artery Forceps
 Pinzas hemostáticas
 Pincés hémostatiques
 Pinze emostatiche

AA
 AB
 AC
 AD
 AE
 AF
 AG
 AH
 AI
 AJ
 AK
 AL
 AM
 AN
 AO
 AP
 AQ
 AR
 AS
 AT
 AU
 AV
 AW
 AX
 AY
 AZ
 BA
 BB
 BC
 BD
 BE
 BF
 BG
 BH
 BI
 BJ
 BK
 BL
 BM
 BN
 BO
 BP
 BQ
 BR
 BS
 BT
 BU
 BV
 BW
 BX
 BY
 BZ
 CA
 CB
 CC
 CD
 CE
 CF
 CG
 CH
 CI
 CJ
 CK
 CL
 CM
 CN
 CO
 CP
 CQ
 CR
 CS
 CT
 CU
 CV
 CW
 CX
 CY
 CZ
 DA
 DB
 DC
 DD
 DE
 DF
 DG
 DH
 DI
 DJ
 DK
 DL
 DM
 DN
 DO
 DP
 DQ
 DR
 DS
 DT
 DU
 DV
 DW
 DX
 DY
 DZ
 EA
 EB
 EC
 ED
 EE
 EF
 EG
 EH
 EI
 EJ
 EK
 EL
 EM
 EN
 EO
 EP
 EQ
 ER
 ES
 ET
 EU
 EV
 EW
 EX
 EY
 EZ
 FA
 FB
 FC
 FD
 FE
 FF
 FG
 FH
 FI
 FJ
 FK
 FL
 FM
 FN
 FO
 FP
 FQ
 FR
 FS
 FT
 FU
 FV
 FW
 FX
 FY
 FZ
 GA
 GB
 GC
 GD
 GE
 GF
 GG
 GH
 GI
 GJ
 GK
 GL
 GM
 GN
 GO
 GP
 GQ
 GR
 GS
 GT
 GU
 GV
 GW
 GX
 GY
 GZ
 HA
 HB
 HC
 HD
 HE
 HF
 HG
 HH
 HI
 HJ
 HK
 HL
 HM
 HN
 HO
 HP
 HQ
 HR
 HS
 HT
 HU
 HV
 HW
 HX
 HY
 HZ
 IA
 IB
 IC
 ID
 IE
 IF
 IG
 IH
 II
 IJ
 IK
 IL
 IM
 IN
 IO
 IP
 IQ
 IR
 IS
 IT
 IU
 IV
 IW
 IX
 IY
 IZ
 JA
 JB
 JC
 JD
 JE
 JF
 JG
 JH
 JI
 JJ
 JK
 JL
 JM
 JN
 JO
 JP
 JQ
 JR
 JS
 JT
 JU
 JV
 JW
 JX
 JY
 JZ
 KA
 KB
 KC
 KD
 KE
 KF
 KG
 KH
 KI
 KJ
 KK
 KL
 KM
 KN
 KO
 KP
 KQ
 KR
 KS
 KT
 KU
 KV
 KW
 KX
 KY
 KZ
 LA
 LB
 LC
 LD
 LE
 LF
 LG
 LH
 LI
 LJ
 LK
 LL
 LM
 LN
 LO
 LP
 LQ
 LR
 LS
 LT
 LU
 LV
 LW
 LX
 LY
 LZ
 MA
 MB
 MC
 MD
 ME
 MF
 MG
 MH
 MI
 MJ
 MK
 ML
 MM
 MN
 MO
 MP
 MQ
 MR
 MS
 MT
 MU
 MV
 MW
 MX
 MY
 MZ
 NA
 NB
 NC
 ND
 NE
 NF
 NG
 NH
 NI
 NJ
 NK
 NL
 NM
 NN
 NO
 NP
 NQ
 NR
 NS
 NT
 NU
 NV
 NW
 NX
 NY
 NZ
 OA
 OB
 OC
 OD
 OE
 OF
 OG
 OH
 OI
 OJ
 OK
 OL
 OM
 ON
 OO
 OP
 OQ
 OR
 OS
 OT
 OU
 OV
 OW
 OX
 OY
 OZ
 PA
 PB
 PC
 PD
 PE
 PF
 PG
 PH
 PI
 PJ
 PK
 PL
 PM
 PN
 PO
 PP
 PQ
 PR
 PS
 PT
 PU
 PV
 PW
 PX
 PY
 PZ
 QA
 QB
 QC
 QD
 QE
 QF
 QG
 QH
 QI
 QJ
 QK
 QL
 QM
 QN
 QO
 QP
 QQ
 QR
 QS
 QT
 QU
 QV
 QW
 QX
 QY
 QZ
 RA
 RB
 RC
 RD
 RE
 RF
 RG
 RH
 RI
 RJ
 RK
 RL
 RM
 RN
 RO
 RP
 RQ
 RR
 RS
 RT
 RU
 RV
 RW
 RX
 RY
 RZ
 SA
 SB
 SC
 SD
 SE
 SF
 SG
 SH
 SI
 SJ
 SK
 SL
 SM
 SN
 SO
 SP
 SQ
 SR
 SS
 ST
 SU
 SV
 SW
 SX
 SY
 SZ
 TA
 TB
 TC
 TD
 TE
 TF
 TG
 TH
 TI
 TJ
 TK
 TL
 TM
 TN
 TO
 TP
 TQ
 TR
 TS
 TT
 TU
 TV
 TW
 TX
 TY
 TZ
 UA
 UB
 UC
 UD
 UE
 UF
 UG
 UH
 UI
 UJ
 UK
 UL
 UM
 UN
 UO
 UP
 UQ
 UR
 US
 UT
 UY
 UZ
 VA
 VB
 VC
 VD
 VE
 VF
 VG
 VH
 VI
 VJ
 VK
 VL
 VM
 VN
 VO
 VP
 VQ
 VR
 VS
 VT
 VY
 VZ
 WA
 WB
 WC
 WD
 WE
 WF
 WG
 WH
 WI
 WJ
 WK
 WL
 WM
 WN
 WO
 WP
 WQ
 WR
 WS
 WT
 WY
 WZ
 XA
 XB
 XC
 XD
 XE
 XF
 XG
 XH
 XI
 XJ
 XK
 XL
 XM
 XN
 XO
 XP
 XQ
 XR
 XS
 XT
 XU
 XV
 XW
 XX
 XY
 XZ
 YA
 YB
 YC
 YD
 YE
 YF
 YG
 YH
 YI
 YJ
 YK
 YL
 YM
 YN
 YO
 YP
 YQ
 YR
 YS
 YT
 YZ
 ZA
 ZB
 ZC
 ZD
 ZE
 ZF
 ZG
 ZH
 ZI
 ZJ
 ZK
 ZL
 ZM
 ZN
 ZO
 ZP
 ZQ
 ZR
 ZS
 ZT
 ZY
 ZZ



ROCHESTER-PEAN

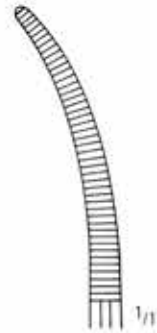

AA 201/14
 14,0 cm/5 1/2"

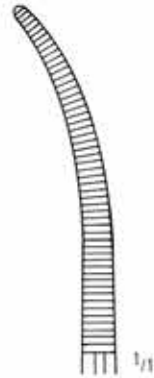

AA 201/16
 16,0 cm/6 1/4"

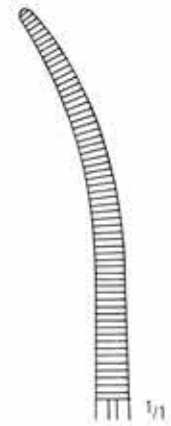

AA 201/18
 18,0 cm/7"

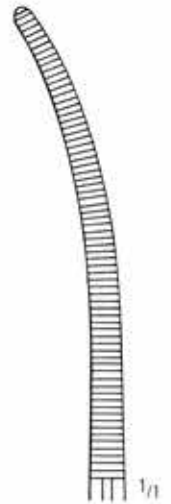

AA 201/20
 20,0 cm/8"

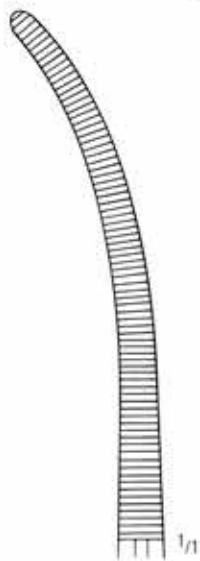

AA 201/22
 22,0 cm/8 3/4"

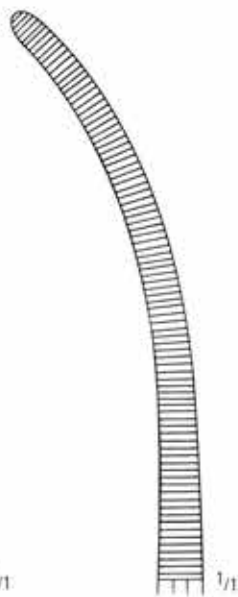

AA 201/24
 24,0 cm/9 1/2"

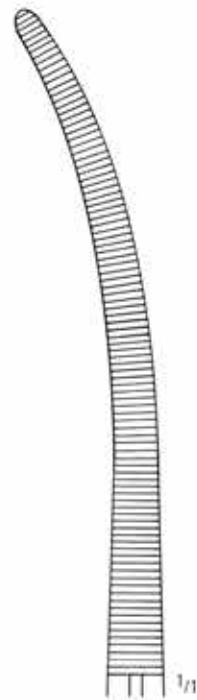

AA 201/26
 26,0 cm/10 1/2"

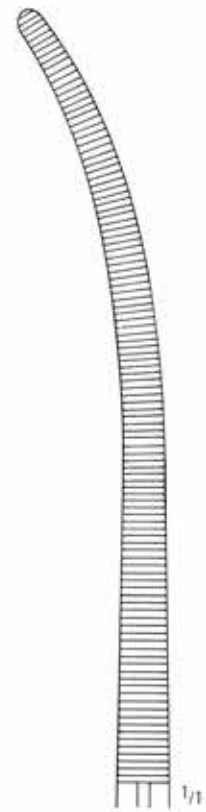

AA 201/30
 30,0 cm/12"

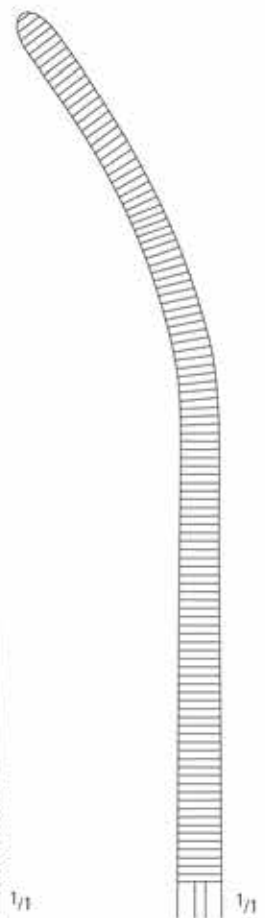

AA 201/36
 36,0 cm/14"

Arterienklemmen
 Artery Forceps
 Pinzas hemostáticas
 Pincés hémostatiques
 Pinze emostatiche



OCHSNER-KOCHER 1:2

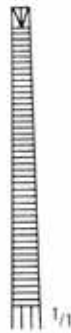

AA 210/14
 14,0 cm/5 1/2"

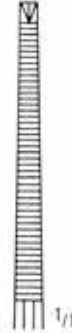

AA 210/16
 16,0 cm/6 1/4"

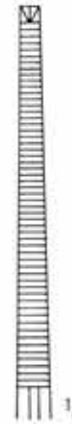

AA 210/18
 18,0 cm/7"

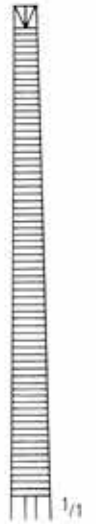

AA 210/20
 20,0 cm/8"

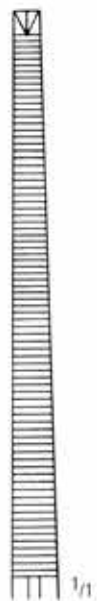

AA 210/22
 22,0 cm/8 3/4"

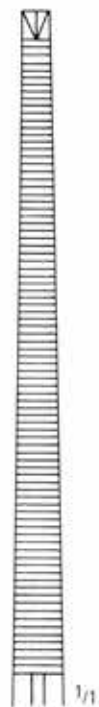

AA 210/24
 24,0 cm/9 1/2"

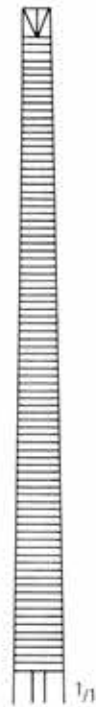

AA 210/26
 26,0 cm/10 1/2"



AA 210/30
 30,0 cm/12"

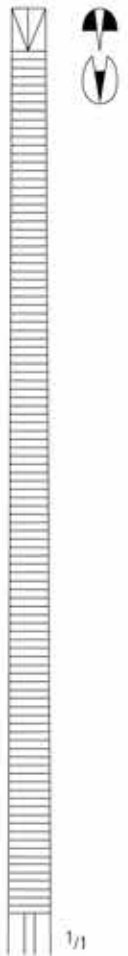

AA 210/36
 36,0 cm/14"

Arterienklemmen
 Artery Forceps
 Pinzas hemostáticas
 Pincas hémostatiques
 Pinze emostatiche



OCHSNER-KOCHER 1:2



AA 211/14
 14,0 cm/5 1/2"



AA 211/16
 16,0 cm/6 1/4"

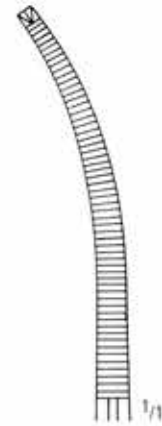

AA 211/18
 18,0 cm/7"



AA 211/20
 20,0 cm/8"



AA 211/22
 22,0 cm/8 3/4"

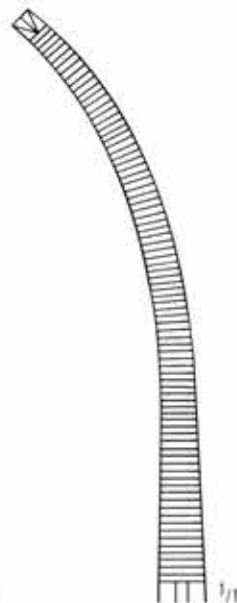

AA 211/24
 24,0 cm/9 1/2"

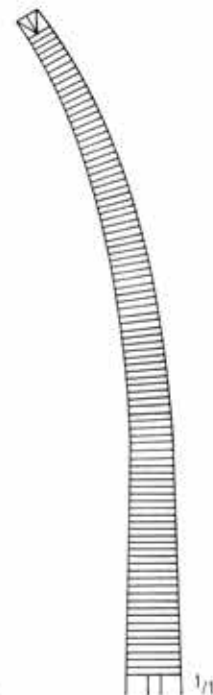

AA 211/26
 26,0 cm/10 1/2"

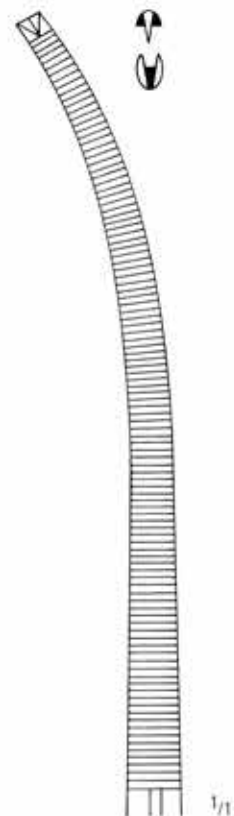

AA 211/30
 30,0 cm/12"

AA

AB

AC

AD

AE

AF

AK

AL

AM

AO

AP

AR

KA

KD

KU

KV

Grazile Arterienklemmen
 Delicate Artery Forceps
 Pinzas hemostáticas delgadas
 Pincés hémostatiques graciles
 Pinze emostatiche delicate

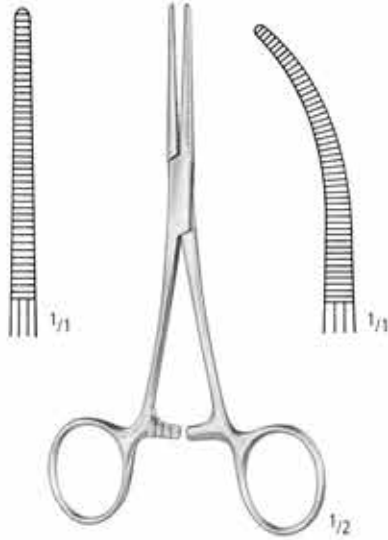

PEAN - DELICATE

- | | |
|-----------|-----------|
| AA 214/13 | AA 215/13 |
| AA 214/14 | AA 215/14 |
| AA 214/16 | AA 215/16 |

- | |
|----------------|
| 13,0 cm/5" |
| 14,0 cm/5 1/2" |
| 16,0 cm/6 1/4" |

JULES PEAN, born 1830, died 1898, was the most important French gynecological surgeon of his time. He studied at Paris 1860. 1864 Pean was the first surgeon in Paris to perform an ovariectomy. By the use of Pean pins he introduced forceps pressure for control of hemorrhage, thus he invented the most used surgical instrument, next to the scalpel.

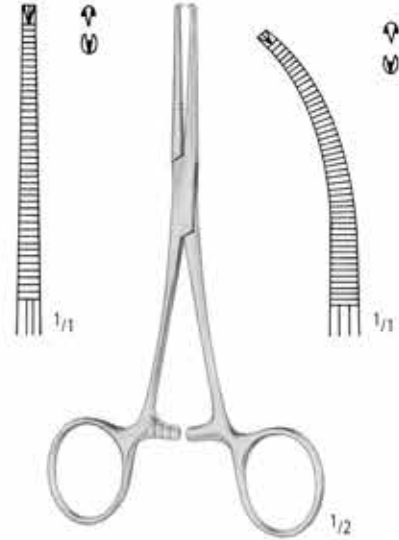

KOCHER 1:2 - DELICATE

- | | |
|-----------|-----------|
| AA 216/13 | AA 217/13 |
| AA 216/14 | AA 217/14 |
| AA 216/16 | AA 217/16 |

ALBERT J. OCHSNER, born 1858, died 1925. He devoted much time to attending and participating in medical discussions and was member of all leading societies in his fields.

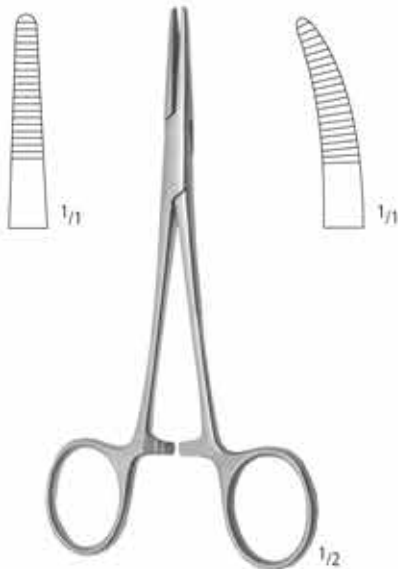

CAIRNS

- | | | |
|-----------|------------|-----------|
| AA 218/15 | 15,0 cm/6" | AA 219/15 |
|-----------|------------|-----------|



DUNHILL

- | | |
|-----------|------------|
| AA 220/13 | 13,0 cm/5" |
|-----------|------------|

Arterienklemmen, Präparier- und Ligaturklemmen
 Artery Forceps, Dissecting and Ligature Forceps
 Pinzas hemostáticas, Pinzas para preparaciones y ligaduras
 Pincés hémostatiques, Pincés à disséquer et à ligatures
 Pinze emostatiche, Pinze per preparazioni e legature

AA
 AB
 AC
 AD
 AE
 AF
 AK
 AL
 AM
 AO
 AP
 AR
 KA
 KD
 KU
 KY



OVERHOLT-GEISSENDOERFER

21,0 cm/8¹/₄"
 27,0 cm/10³/₄"

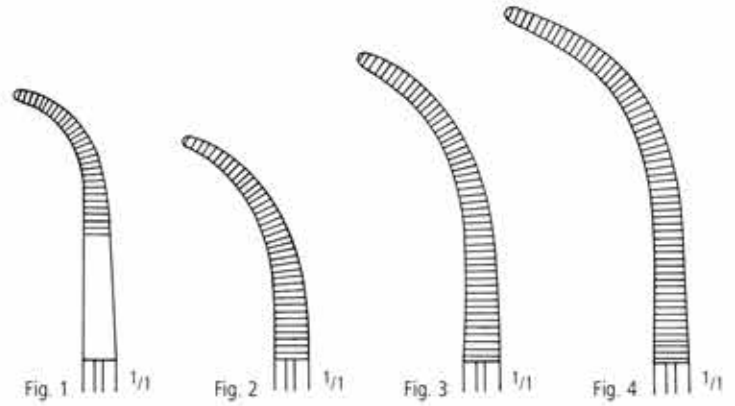
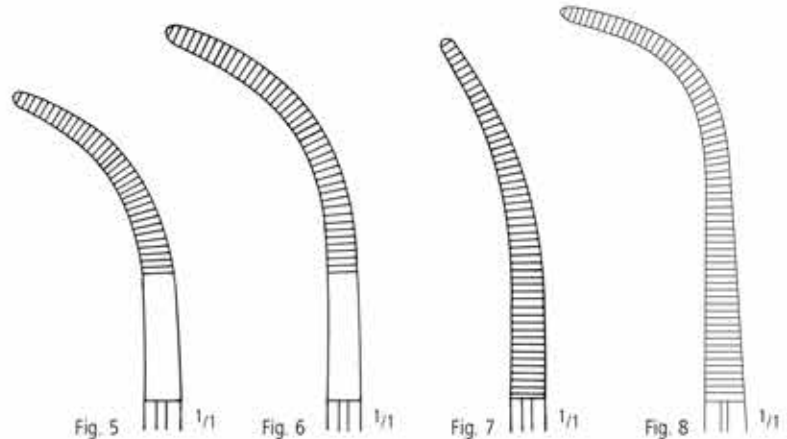

Fig. 1 1/1 AA 221/01 AA 223/01
 Fig. 2 1/1 AA 221/02 AA 223/02
 Fig. 3 1/1 AA 221/03 AA 223/03
 Fig. 4 1/1 AA 221/04 AA 223/04



21,0 cm/8¹/₄"
 27,0 cm/10³/₄"
 29,5 cm/11¹/₂"

Fig. 5 1/1 AA 221/05 AA 223/05
 Fig. 6 1/1 AA 221/06 AA 223/06
 Fig. 7 1/1 AA 221/07 AA 223/07
 Fig. 8 1/1 AA 224/08



BABY-OVERHOLT

AA 225/13
 13,5 cm/5¹/₄"

Präparier- und Ligaturklemmen
 Dissecting and Ligature Forceps
 Pinzas para preparaciones y ligaduras
 Pincès à disséquer et à ligatures
 Pinze per preparazioni e legature

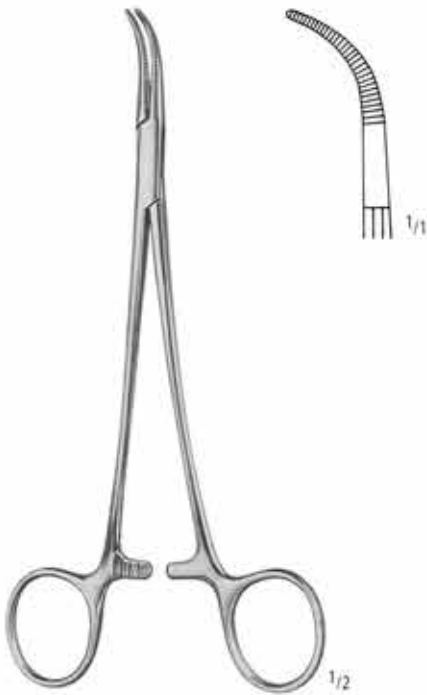

OVERHOLT
AA 229/01
 18,5 cm/7¹/₃"

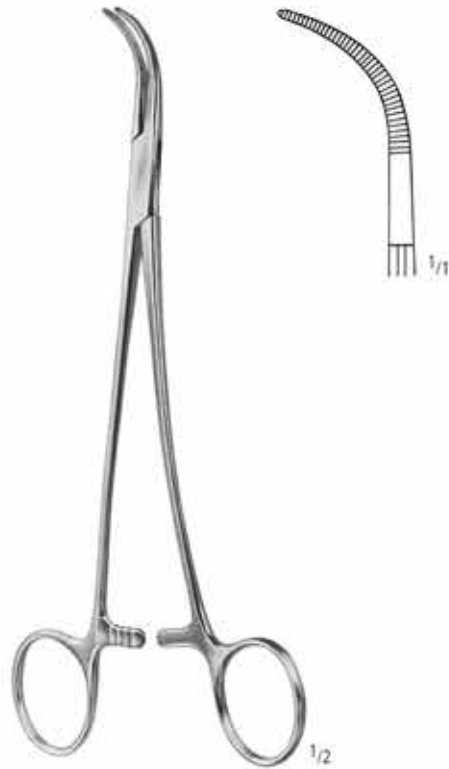

OVERHOLT
AA 229/02
 20,5 cm/8"

S-förmig gebogen
 S-shaped
 curvas en S
 courbes en S
 curve in S

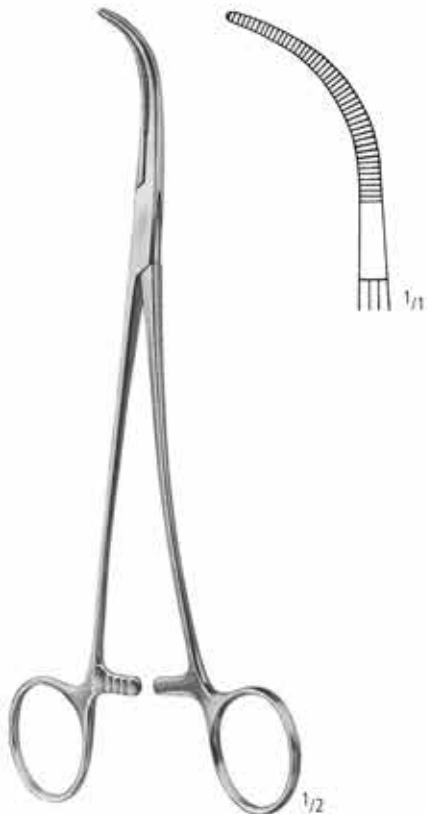

OVERHOLT
AA 229/03
 21,0 cm/8¹/₄"

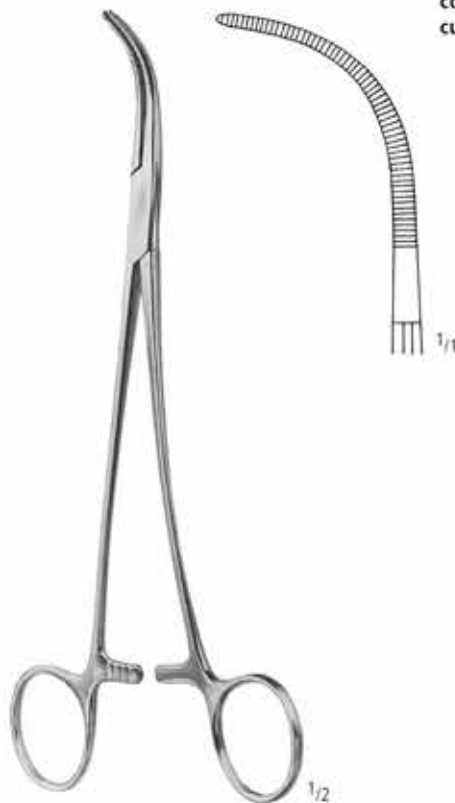

OVERHOLT
AA 229/04
 21,5 cm/8¹/₂"

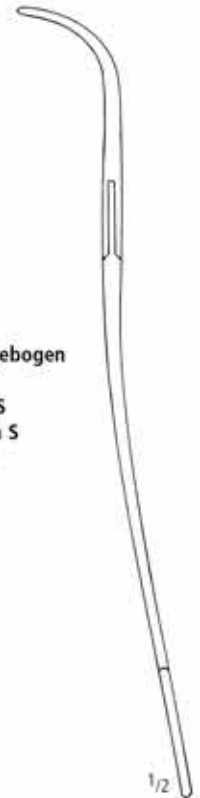

KLEMMEN HEMOSTATS PINZAS HEMOSTATICAS PINCES HEMOSTATIQUES PINZE EMOSTATICHE

Arterienklemmen, Präparier- und Ligaturklemmen
 Artery Forceps, Dissecting and Ligature Forceps
 Pinzas hemostáticas, Pinzas para preparaciones y ligaduras
 Pincés hémostatiques, Pincés à disséquer et à ligatures
 Pinze emostatiche, Pinze per preparazioni e legature

AA

AB

AC

AD

AE

AF

AK

AL

AM

AO

AP

AR

KA

KD

KU

KY

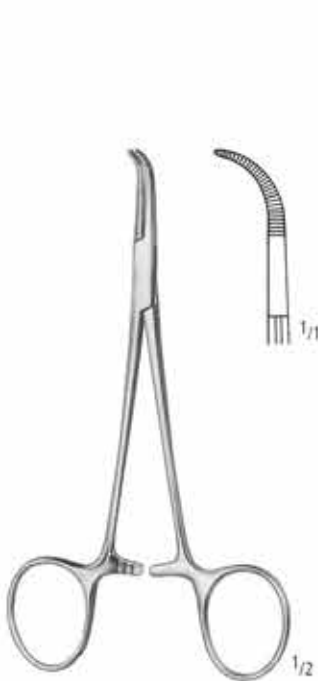

BABY-ADSON
AA 235/14
 14,0 cm/5 1/2"

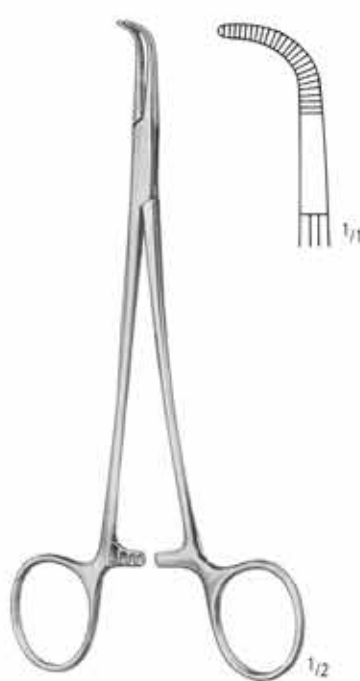

BABY-ADSON
AA 237/18
 18,0 cm/7"

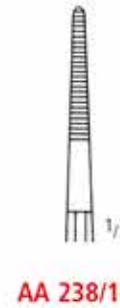

AA 238/18

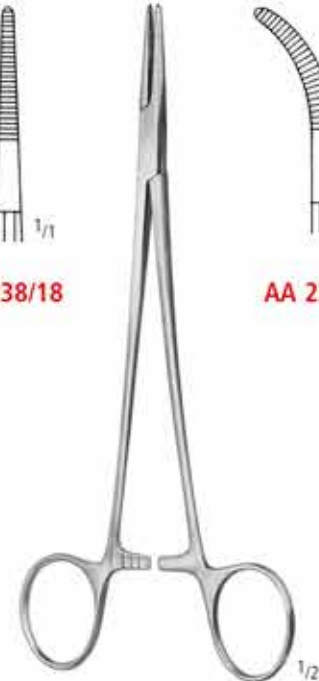

ADSON
 18,5 cm/7 1/8"

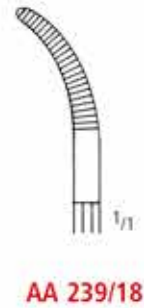

AA 239/18



AA 240/18

AA 241/18

ADSON 1:2
 18,5 cm/7 1/8"



MEEKER

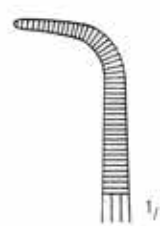

AA 251/18
 18,0 cm/7"



AA 251/28
 28,0 cm/11"

Arterienklemmen, Kopfhautklemmen
 Artery Forceps, Scalp Flap Forceps
 Pinzas hemostáticas, Pinzas hemostáticas para pericráneo
 Pincés hémostatiques, Pincés hémostatiques pour le cuir chevelu
 Pinze emostatiche, Pinze emostatiche per il cuoio capelluto



DIXON-LOVELACE
AA 286/15
 15,5 cm/6"



DIXON-LOVELACE 1:2
AA 288/15
 15,5 cm/6"

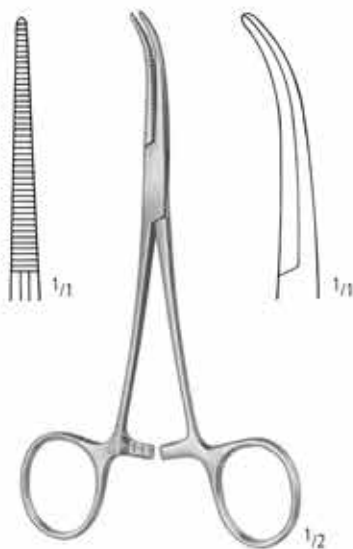

DANDY
AA 291/14
 14,0 cm/5 1/2"

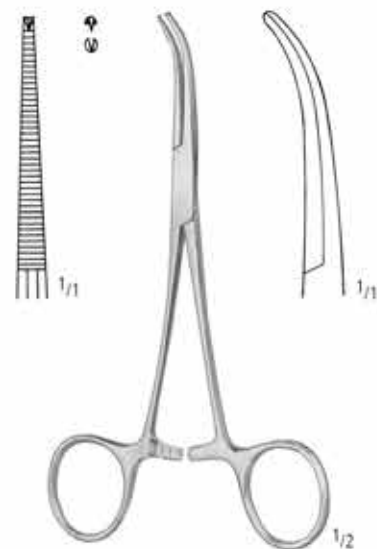

DANDY 1:2
AA 293/14
 14,0 cm/5 1/2"

KLEMMEN HEMOSTATS PINZAS HEMOSTATICAS PINCES HEMOSTATIQUES PINZE EMOSTATICHE

Tonsillenklemmen, Arterienklemmen
 Tonsil Hemostatic Forceps, Artery Forceps
 Pinzas hemostáticas para amígdalas, Pinzas hemostáticas
 Pincés hémostatiques pour amygdales, Pincés hémostatiques
 Pinze emostatiche per tonsille, Pinze emostatiche

AA
 AB
 AC
 AD
 AE
 AF
 AG
 AH
 AI
 AJ
 AK
 AL
 AM
 AN
 AO
 AP
 AQ
 AR
 AS
 AT
 AU
 AV
 AW
 AX
 AY
 AZ

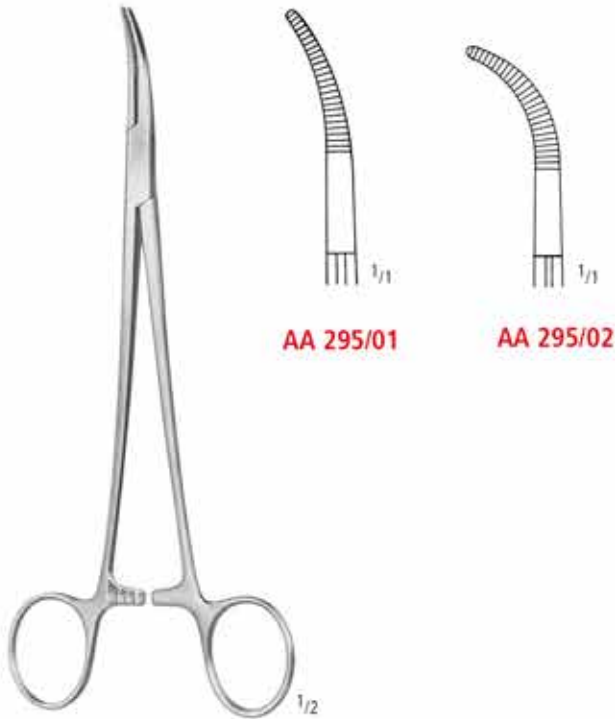

AA 295/01 AA 295/02

SCHNIDT-SAWTELL
 19,0 cm/7 1/2"

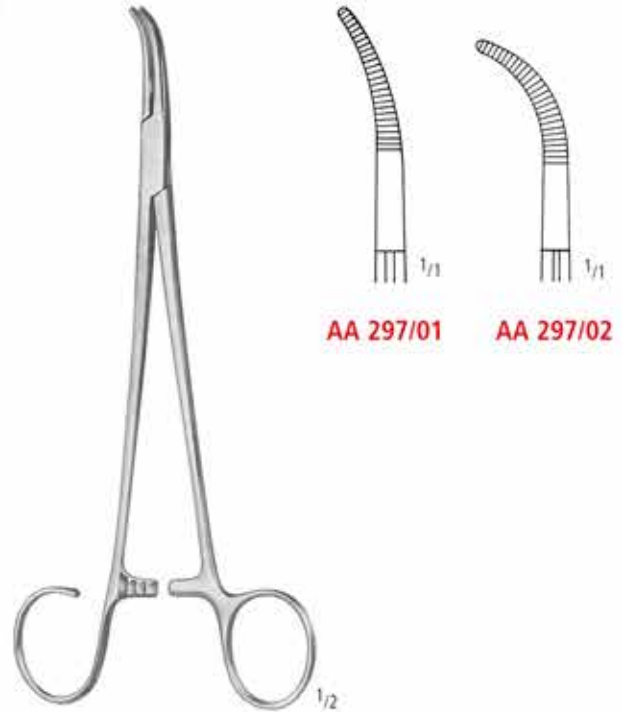

AA 297/01 AA 297/02

SCHNIDT-SAWTELL
 19,0 cm/7 1/2"

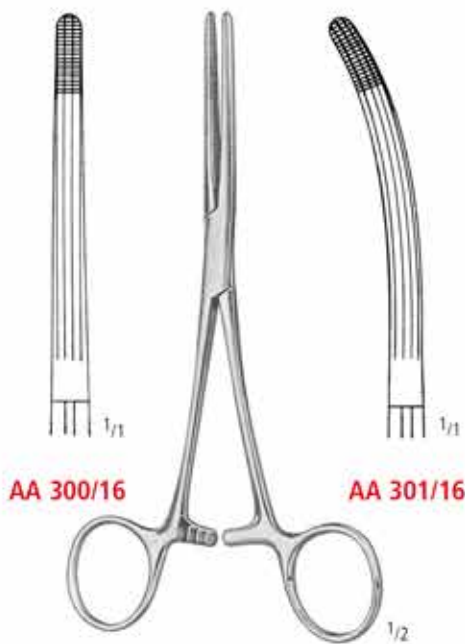

AA 300/16 AA 301/16

ROCHESTER-CARMALT

AA 300/16 16,0 cm/6 1/4"
 AA 300/20 20,0 cm/8" AA 301/16 AA 301/20

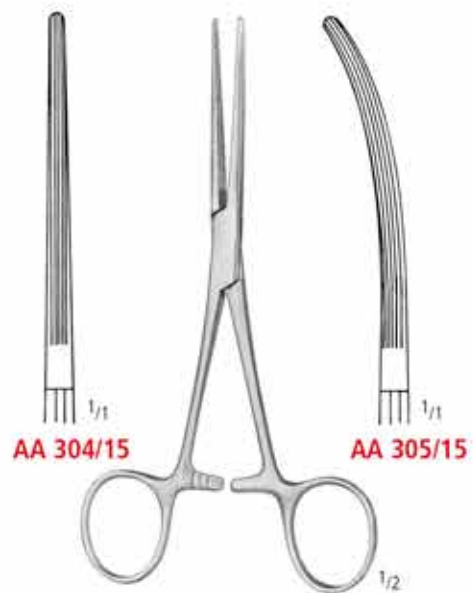

AA 304/15 AA 305/15

BAINBRIDGE

AA 304/15 15,0 cm/6"
 AA 304/18 18,5 cm/7 1/3" AA 305/15 AA 305/18

Arterienklemmen
 Artery Forceps
 Pinzas hemostáticas
 Pincés hémostatiques
 Pinze emostatiche

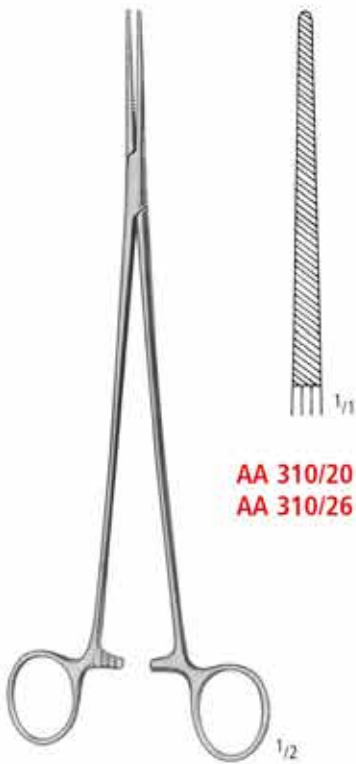

BENGOLEA

AA 310/20 20,0 cm/8"
AA 310/26 26,0 cm/10¹/₂"



AA 311/20
AA 311/26



BENGOLEA 1:2

AA 312/20 20,0 cm/8"
AA 312/26 26,0 cm/10¹/₂"



AA 313/20
AA 313/26

Aurikelklemmen, Präparier- und Ligaturklemmen
 Auricle Forceps, Dissecting and Ligature Forceps
 Pinzas para aurícula, Pinzas para preparaciones y ligaduras
 Pincés auriculaires, Pincés à disséquer et à ligatures
 Pinza auricolari, Pinze per preparazioni e legature

AA

AB

AC

AD

AE

AF

AK

AL

AM

AO

AP

AR

KA

KD

KU

KY

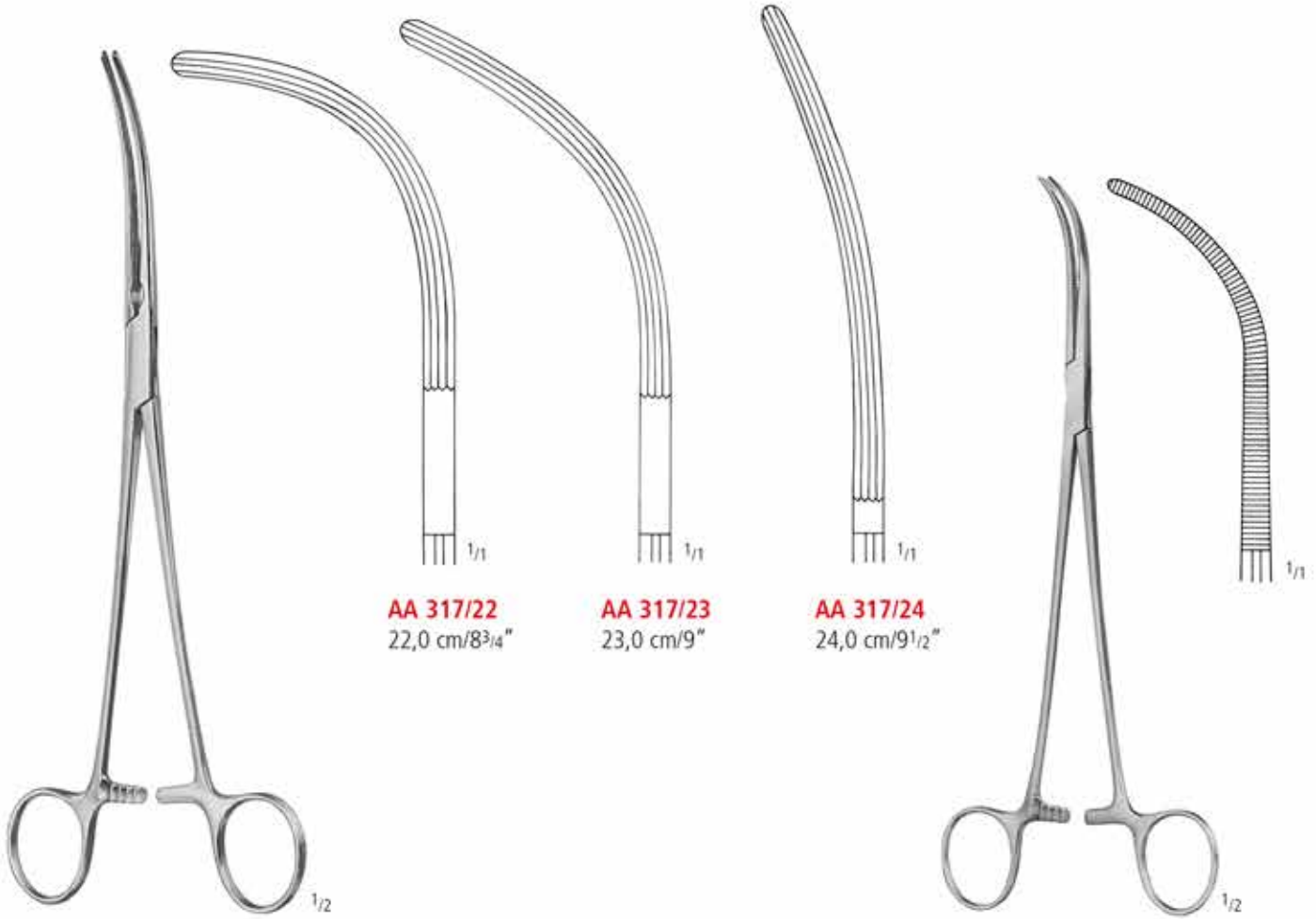

CRAFOORD-SELLORS

AA 317/22
 22,0 cm/8³/₄"

AA 317/23
 23,0 cm/9"

AA 317/24
 24,0 cm/9¹/₂"

OVERHOLT-MIXTER

AA 319/21
 21,0 cm/8¹/₄"

Arterienklemmen, Bronchusklemmen
 Artery Forceps, Bronchus Forceps
 Pinzas hemostáticas, Pinzas-clamps bronquiales
 Pincés hémostatiques, Pincés-clamps à bronches
 Pinze emostatiche, Pinze per bronchi

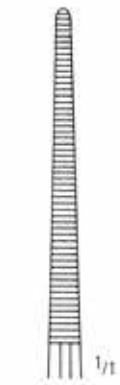

Fig. 1
AA 320/01

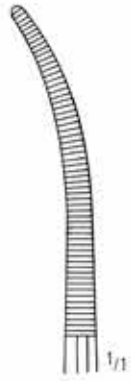

Fig. 2
AA 320/02

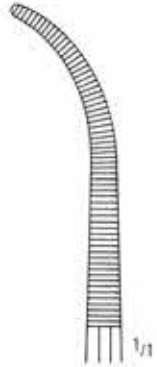
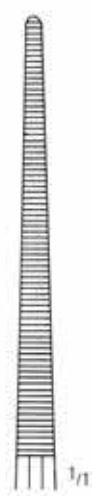
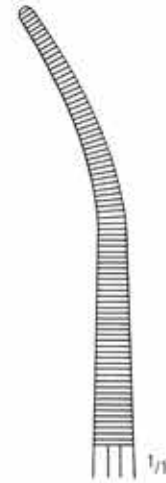

Fig. 3
AA 320/03



AA 322/22



AA 323/22

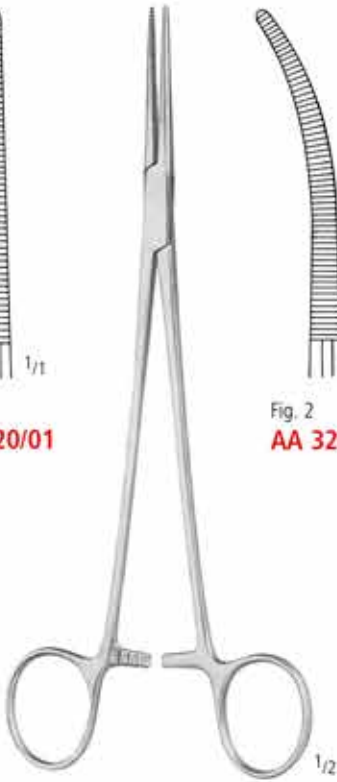

HEISS
 20,0 cm/8"

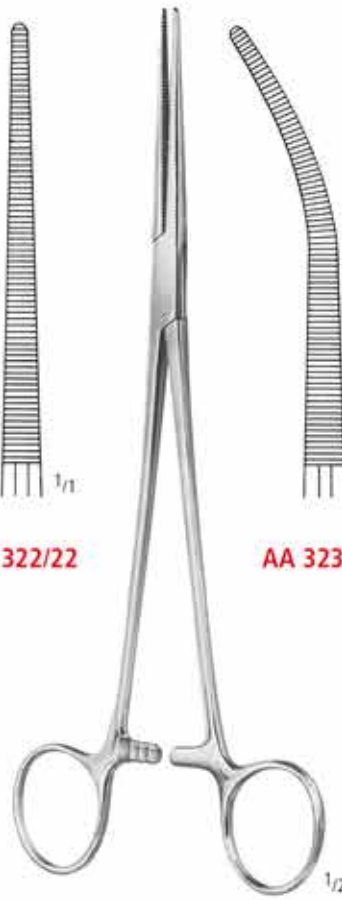

ROBERTS
 22,0 cm/8³/₄"

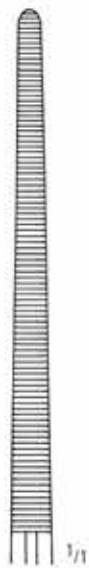

AA 328/24

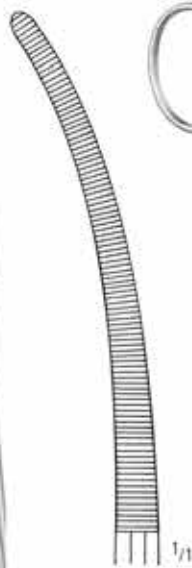

AA 329/24

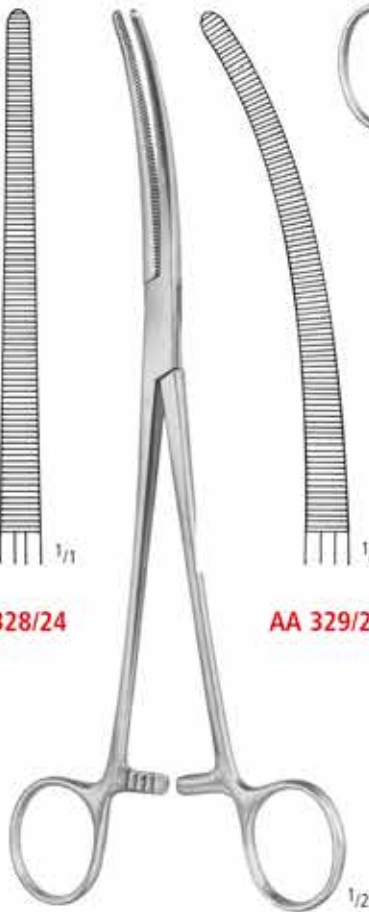

SAROT
 24,0 cm/9¹/₂"

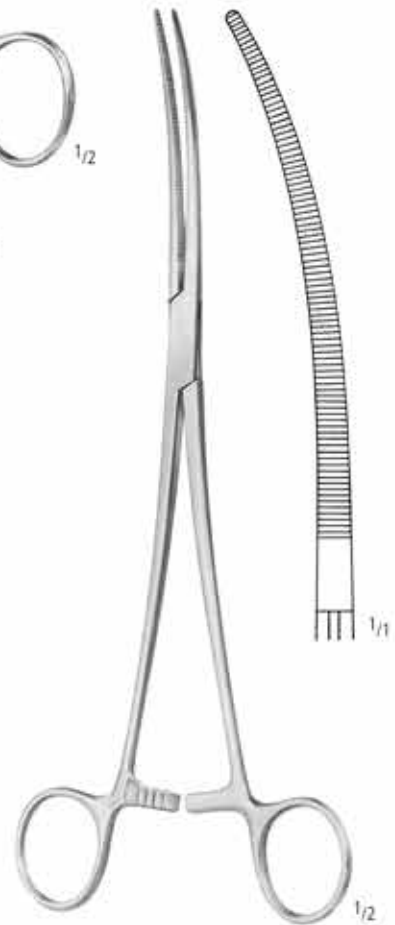
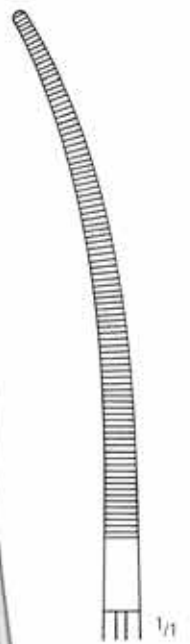

CRAFOORD
AA 330/24
 24,0 cm/9¹/₂"

Präparier- und Ligaturklemmen
 Dissecting and Ligature Forceps
 Pinzas para preparaciones y ligaduras
 Pincès à disséquer et à ligatures
 Pinze per preparazioni e legature

AA

AB

AC

AD

AE

AF

AK

AL

AM

AO

AP

AR

KA

KD

KU

KY



RUMEL
 23,0 cm/9"



AA 335/01

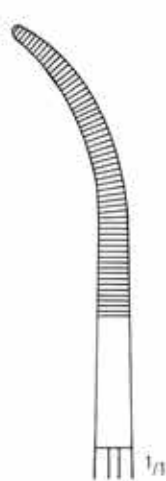

AA 335/02

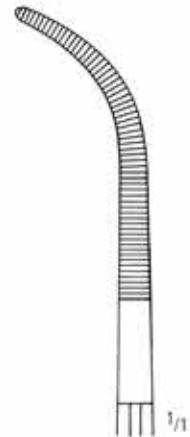

AA 335/03

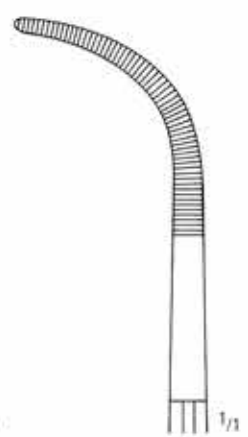

AA 335/04

Präparier- und Ligaturklemmen
 Dissecting and Ligature Forceps
 Pinzas para preparaciones y ligaduras
 Pincès à disséquer et à ligatures
 Pinze per preparazioni e legature

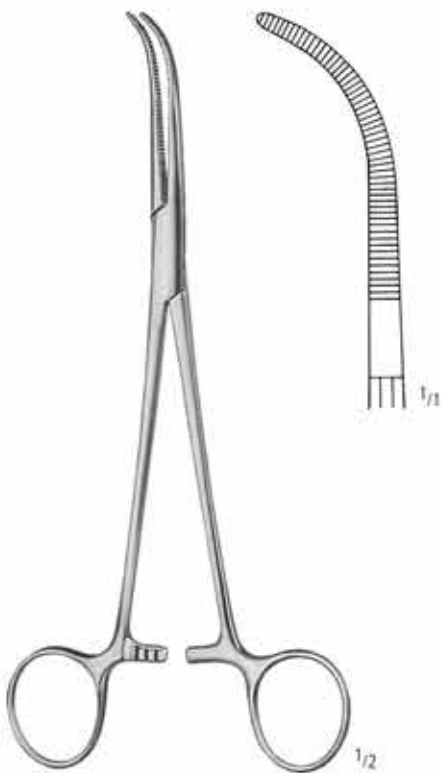

JOHNS HOPKINS
AA 338/20
 20,0 cm/8"

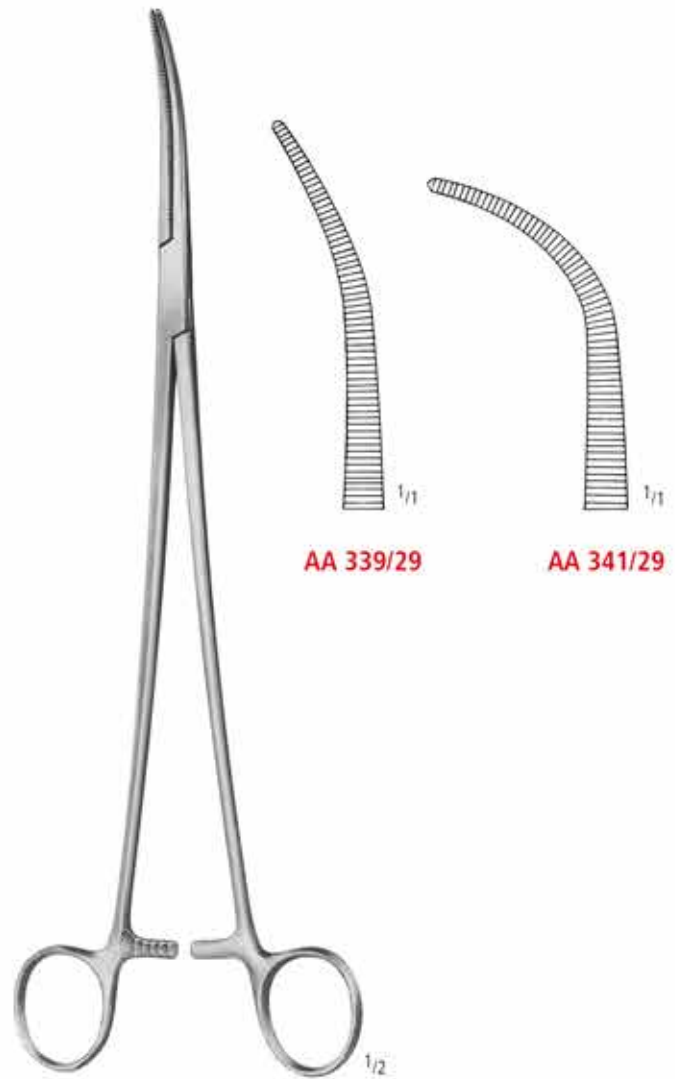

AA 339/29

AA 341/29

ZENKER
 29,5 cm/11 1/2"

Präparier- und Ligaturklemmen
 Dissecting and Ligature Forceps
 Pinzas para preparaciones y ligaduras
 Pincès à disséquer et à ligatures
 Pinze per preparazioni e legature



MIXTER
 15,5 cm/6"
 19,0 cm/7 1/2"
AA 345/15
AA 345/19

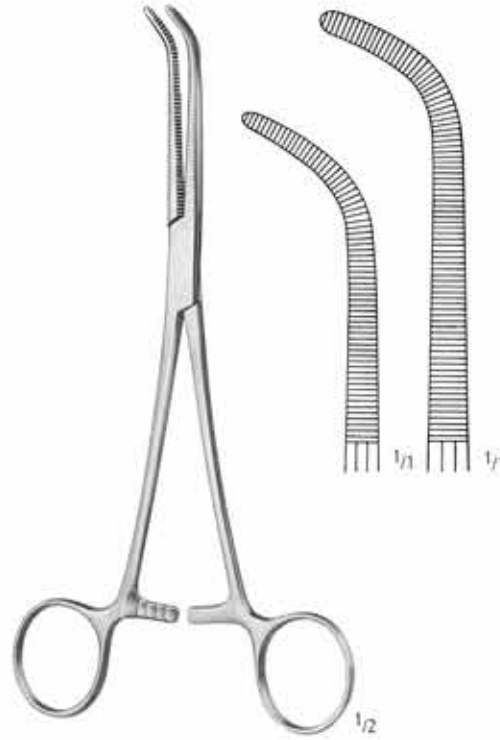

MIXTER-O'SHAUGNESSY
 15,5 cm/6"
 19,0 cm/7 1/2"
AA 347/15
AA 347/19

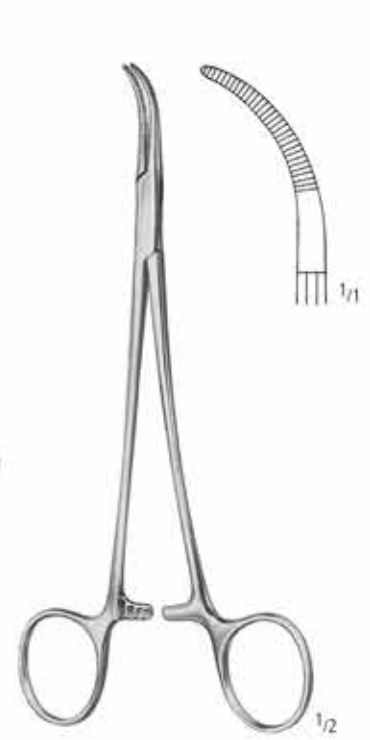

BABY-MIXTER
AA 348/18
 18,0 cm/7"

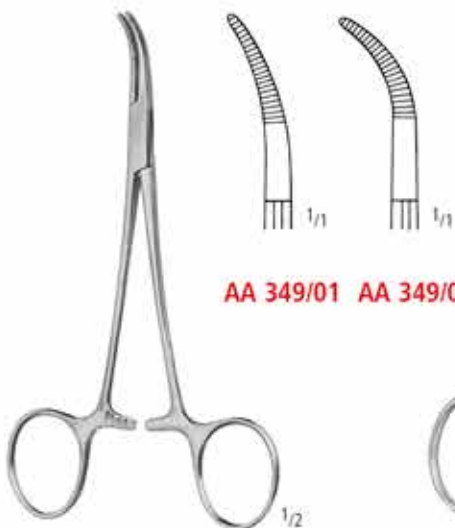

AA 349/01 **AA 349/02**

BABY-MIXTER
 14,0 cm/5 1/2"



MIXTER

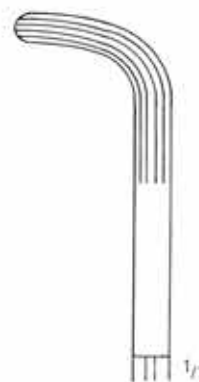

Fig. 1
AA 353/22
 22,0 cm/8 3/4"

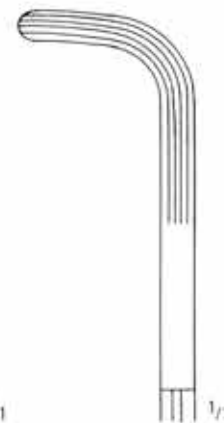

Fig. 2
AA 353/25
 25,0 cm/10"

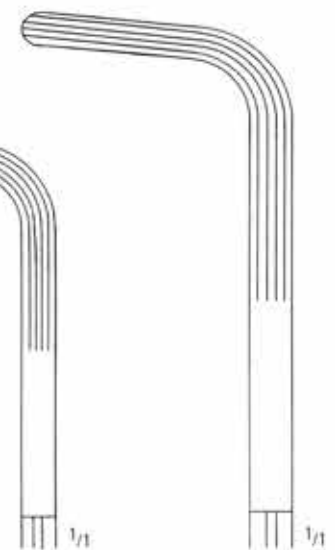

Fig. 3
AA 353/28
 28,0 cm/11"

AA

AB

AC

AD

AE

AF

AK

AL

AM

AO

AP

AR

KA

KD

KU

KV

Präparier- und Ligaturklemmen
 Dissecting and Ligature Forceps
 Pinzas para preparaciones y ligaduras
 Pincès à disséquer et à ligatures
 Pinze per preparazioni e legature

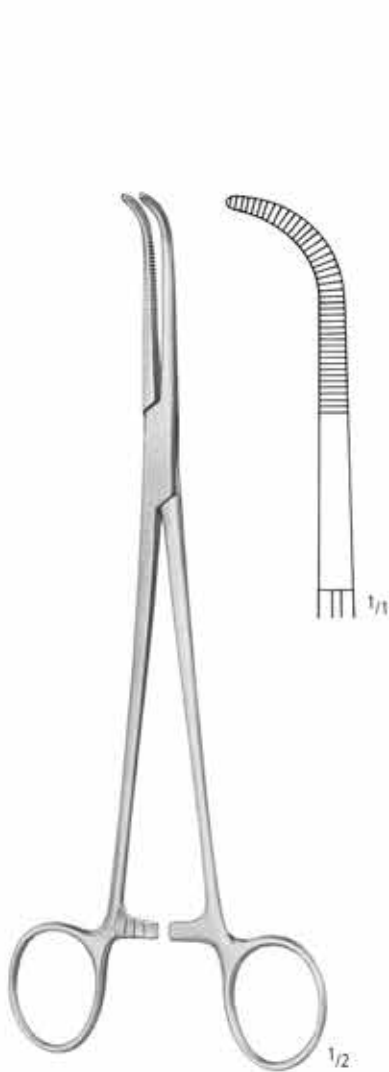

MIXTER
AA 355/23
 23,0 cm/9"



AA 358/28

AA 359/28



LAWRENCE
AA 361/28
 28,0 cm/11"

Präparier- und Ligaturklemmen
 Dissecting and Ligature Forceps
 Pinzas para preparaciones y ligaduras
 Pincès à disséquer et à ligatures
 Pinze per preparazioni e legature

AA

AB

AC

AD

AE

AF

AK

AL

AM

AO

AP

AR

KA

KD

KU

KY



KANTROWITZ

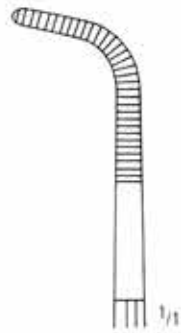

AA 363/20
20,0 cm/8"

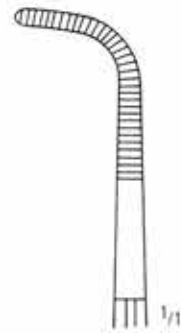

AA 363/24
24,0 cm/9½"

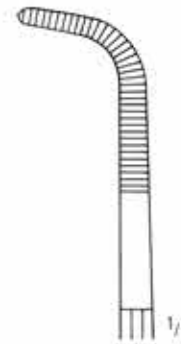

AA 363/28
28,0 cm/11"



GEMINI

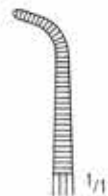

AA 365/14
14,0 cm/5½"



AA 365/18
18,0 cm/7"



AA 365/22
22,0 cm/8¾"

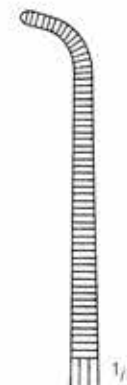

AA 365/25
25,0 cm/10"

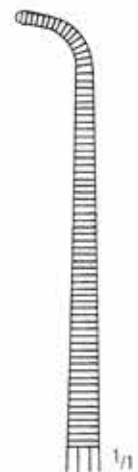

AA 365/28
28,0 cm/11"

Präparier- und Ligaturklemmen
 Dissecting and Ligature Forceps
 Pinzas para preparaciones y ligaduras
 Pincès à disséquer et à ligatures
 Pinze per preparazioni e legature

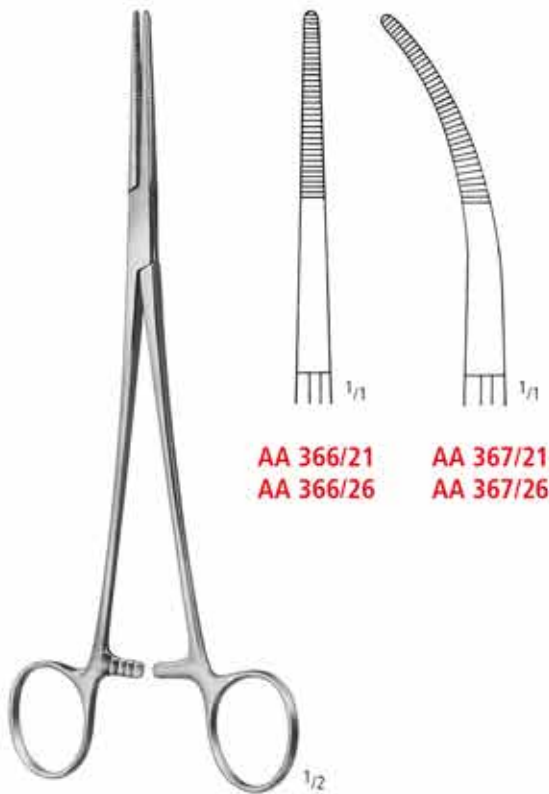

AA 366/21
 AA 366/26

AA 367/21
 AA 367/26

TOENNIS
 21,0 cm/8¹/₄"
 26,0 cm/10¹/₂"

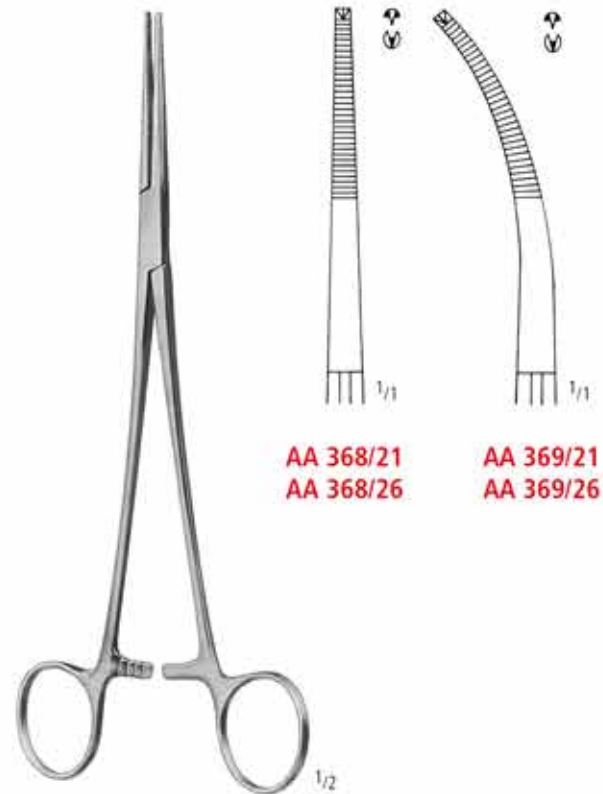

AA 368/21
 AA 368/26

AA 369/21
 AA 369/26

TOENNIS 1:2
 21,0 cm/8¹/₄"
 26,0 cm/10¹/₂"

Gallenkanal- und Nierenstielklemmen
 Gall Duct and Kidney Pedicle Clamp Forceps
 Pinzas-clamps para conducto biliar y pedúnculos renales
 Pincers-clamps pour voies biliaires et pédicules rénaux
 Pinze per vie biliari e peduncoli renali

AA

AB

AC

AD

AE

AF

AK

AL

AM

AO

AP

AR

KA

KD

KU

KY

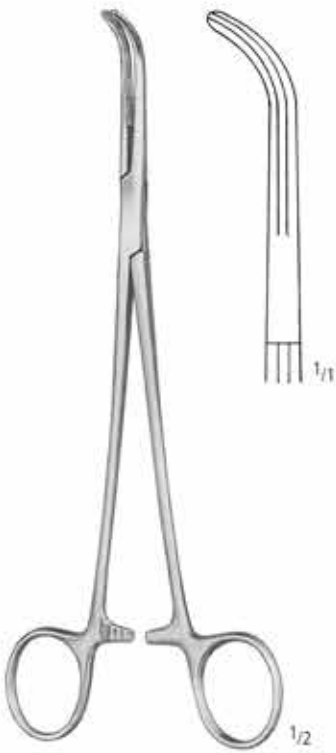

LAHEY
AA 401/19
 19,0 cm/7 1/2"

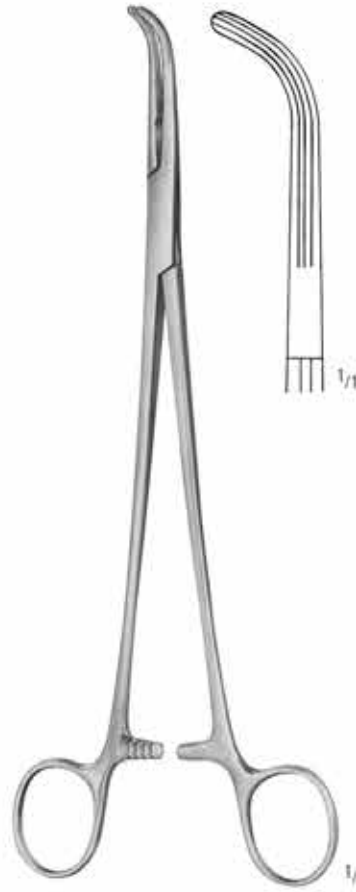

LAHEY
AA 401/23
 23,0 cm/9"



LOWER
AA 403/18
 18,0 cm/7"

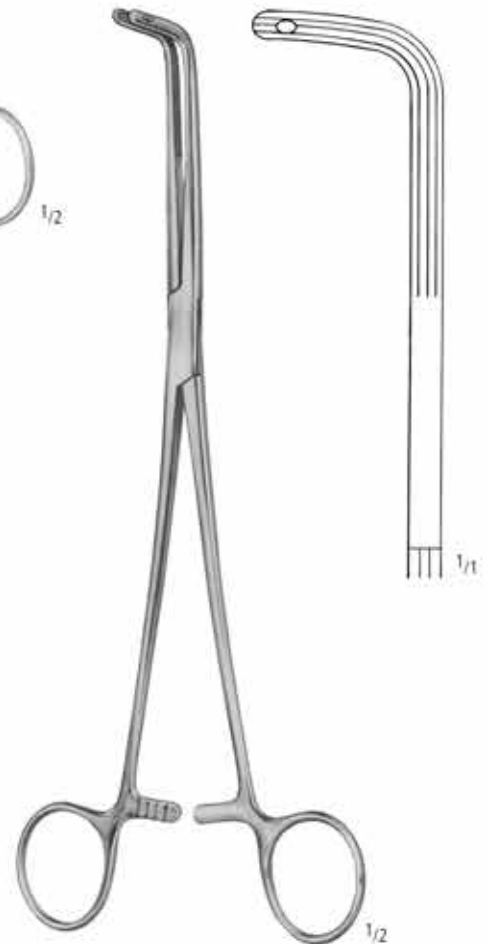

FINOCCHIETTO
AA 405/24
 24,0 cm/9 1/2"

Nierenstielklemmen
 Kidney Pedicle Clamp Forceps
 Pinzas-clamps para pedúnculos renales
 Pincas-clamps pour pédicules rénaux
 Pinze per peduncoli renali

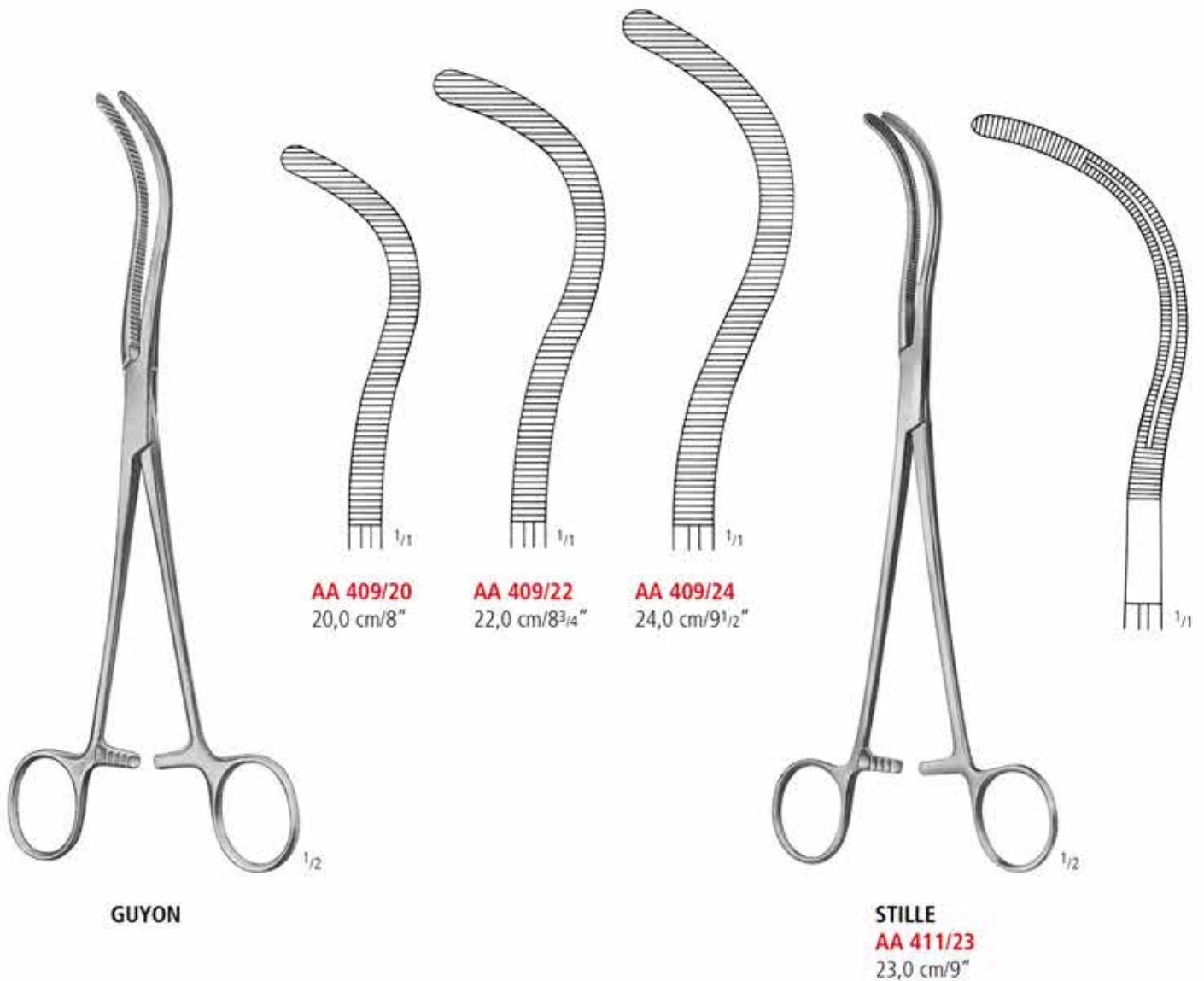

Nierenstielklemmen
Kidney Pedicle Clamp Forceps
Pinzas-clamps para pedúnculos renales
Pincas-clamps pour pédicules rénaux
Pinze per peduncoli renali

AA
AB
AC
AD
AE
AF
AG
AH
AI
AJ
AK
AL
AM
AN
AO
AP
AQ
AR
AS
AT
AU
AV
AW
AX
AY
AZ
BA
BB
BC
BD
BE
BF
BG
BH
BI
BJ
BK
BL
BM
BN
BO
BP
BQ
BR
BS
BT
BU
BV
BW
BX
BY
BZ
CA
CB
CC
CD
CE
CF
CG
CH
CI
CJ
CK
CL
CM
CN
CO
CP
CQ
CR
CS
CT
CU
CV
CW
CX
CY
CZ
DA
DB
DC
DD
DE
DF
DG
DH
DI
DJ
DK
DL
DM
DN
DO
DP
DQ
DR
DS
DT
DU
DV
DW
DX
DY
DZ
EA
EB
EC
ED
EE
EF
EG
EH
EI
EJ
EK
EL
EM
EN
EO
EP
EQ
ER
ES
ET
EU
EV
EW
EX
EY
EZ
FA
FB
FC
FD
FE
FF
FG
FH
FI
FJ
FK
FL
FM
FN
FO
FP
FQ
FR
FS
FT
FU
FV
FW
FX
FY
FZ
GA
GB
GC
GD
GE
GF
GG
GH
GI
GJ
GK
GL
GM
GN
GO
GP
GQ
GR
GS
GT
GU
GV
GW
GX
GY
GZ
HA
HB
HC
HD
HE
HF
HG
HH
HI
HJ
HK
HL
HM
HN
HO
HP
HQ
HR
HS
HT
HU
HV
HW
HX
HY
HZ
IA
IB
IC
ID
IE
IF
IG
IH
II
IJ
IK
IL
IM
IN
IO
IP
IQ
IR
IS
IT
IU
IV
IW
IX
IY
IZ
JA
JB
JC
JD
JE
JF
JG
JH
JI
JJ
JK
JL
JM
JN
JO
JP
JQ
JR
JS
JT
JU
JV
JW
JX
JY
JZ
KA
KB
KC
KD
KE
KF
KG
KH
KI
KJ
KK
KL
KM
KN
KO
KP
KQ
KR
KS
KT
KU
KV
KW
KX
KY
KZ
LA
LB
LC
LD
LE
LF
LG
LH
LI
LJ
LK
LL
LM
LN
LO
LP
LQ
LR
LS
LT
LU
LV
LW
LX
LY
LZ
MA
MB
MC
MD
ME
MF
MG
MH
MI
MJ
MK
ML
MM
MN
MO
MP
MQ
MR
MS
MT
MU
MV
MW
MX
MY
MZ
NA
NB
NC
ND
NE
NF
NG
NH
NI
NJ
NK
NL
NM
NN
NO
NP
NQ
NR
NS
NT
NU
NV
NW
NX
NY
NZ
OA
OB
OC
OD
OE
OF
OG
OH
OI
OJ
OK
OL
OM
ON
OO
OP
OQ
OR
OS
OT
OU
OV
OW
OX
OY
OZ
PA
PB
PC
PD
PE
PF
PG
PH
PI
PJ
PK
PL
PM
PN
PO
PP
PQ
PR
PS
PT
PU
PV
PW
PX
PY
PZ
QA
QB
QC
QD
QE
QF
QG
QH
QI
QJ
QK
QL
QM
QN
QO
QP
QQ
QR
QS
QT
QU
QV
QW
QX
QY
QZ
RA
RB
RC
RD
RE
RF
RG
RH
RI
RJ
RK
RL
RM
RN
RO
RP
RQ
RR
RS
RT
RU
RV
RW
RX
RY
RZ
SA
SB
SC
SD
SE
SF
SG
SH
SI
SJ
SK
SL
SM
SN
SO
SP
SQ
SR
SS
ST
SU
SV
SW
SX
SY
SZ
TA
TB
TC
TD
TE
TF
TG
TH
TI
TJ
TK
TL
TM
TN
TO
TP
TQ
TR
TS
TT
TU
TV
TW
TX
TY
TZ
UA
UB
UC
UD
UE
UF
UG
UH
UI
UJ
UK
UL
UM
UN
UO
UP
UQ
UR
US
UT
UU
UV
UW
UX
UY
UZ
VA
VB
VC
VD
VE
VF
VG
VH
VI
VJ
VK
VL
VM
VN
VO
VP
VQ
VR
VS
VT
VU
VV
VW
VX
VY
VZ
WA
WB
WC
WD
WE
WF
WG
WH
WI
WJ
WK
WL
WM
WN
WO
WP
WQ
WR
WS
WT
WU
WV
WW
WX
WY
WZ
XA
XB
XC
XD
XE
XF
XG
XH
XI
XJ
XK
XL
XM
XN
XO
XP
XQ
XR
XS
XT
XU
XV
XW
XX
XY
XZ
YA
YB
YC
YD
YE
YF
YG
YH
YI
YJ
YK
YL
YM
YN
YO
YP
YQ
YR
YS
YT
YU
YV
YW
YX
YY
YZ
ZA
ZB
ZC
ZD
ZE
ZF
ZG
ZH
ZI
ZJ
ZK
ZL
ZM
ZN
ZO
ZP
ZQ
ZR
ZS
ZT
ZU
ZV
ZW
ZX
ZY
ZZ



GUYON
AA 413/23
23,0 cm/9"

HERRICK
AA 417/23
23,0 cm/9"

GUYON-ARTRAUMATIC

AA 419/23
23,0 cm/9"

AA 419/24
24,0 cm/9 1/2"

Gallenkanalklemmen
 Gall Duct Forceps
 Pinzas-clamps para conducto biliar
 Pincas-clamps pour voies biliaires
 Pinze per vie biliari



GRAY

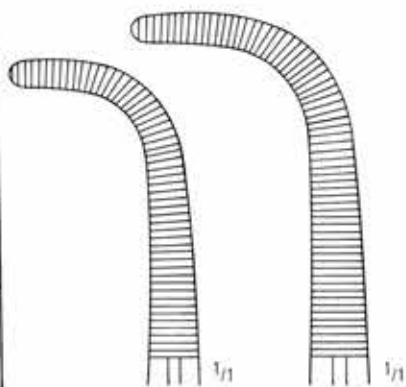
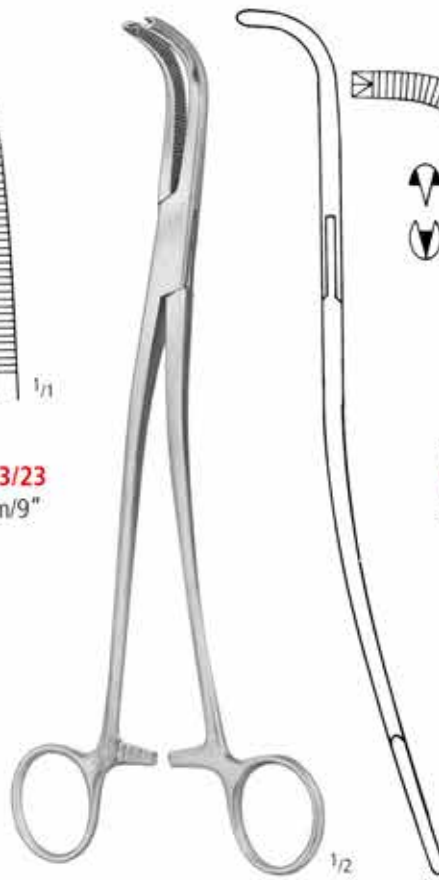

Fig. 1
AA 423/22
 22,0 cm/8³/₄"

Fig. 2
AA 423/23
 23,0 cm/9"



GRAY 1:2

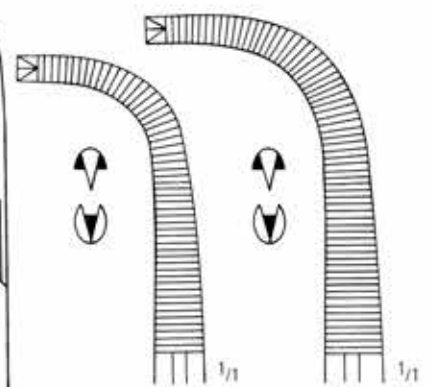
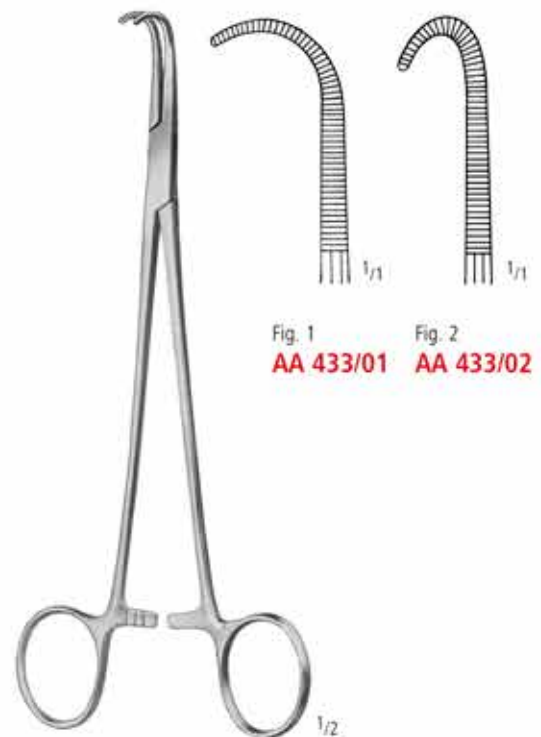

Fig. 1
AA 425/22
 22,0 cm/8³/₄"

Fig. 2
AA 425/23
 23,0 cm/9"



DESJARDINS
AA 429/21
 21,0 cm/8¹/₄"



NEGUS
 19,0 cm/7¹/₂"

Fig. 1
AA 433/01

Fig. 2
AA 433/02

Präparier- und Ligaturklemmen, Hysterektomieklemmen
 Dissecting and Ligature Forceps, Hysterectomy Forceps
 Pinzas para preparaciones y ligaduras, Pinzas-clamps para histerectomia
 Pincès à disséquer et à ligatures, Pincès à hystérectomie
 Pinze per preparazioni e legature, Pinze per isterectomia

AA
 AB
 AC
 AD
 AE
 AF
 AG
 AH
 AI
 AJ
 AK
 AL
 AM
 AN
 AO
 AP
 AQ
 AR
 AS
 AT
 AU
 AV
 AW
 AX
 AY
 AZ

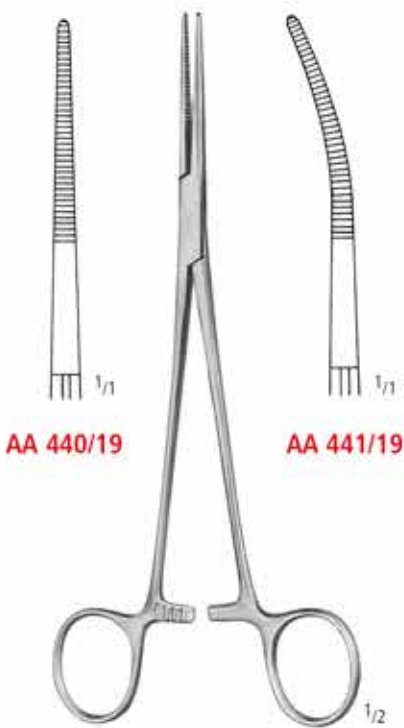

AA 440/19

AA 441/19

BIRKETT
 19,0 cm/7 1/2"

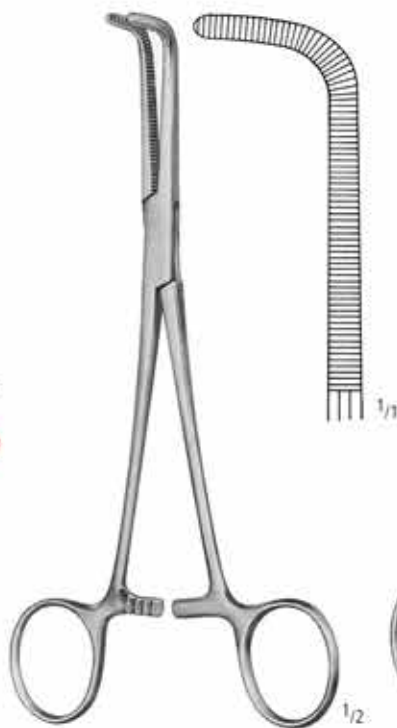

WIKSTROEM
AA 443/19
 19,0 cm/7 1/2"

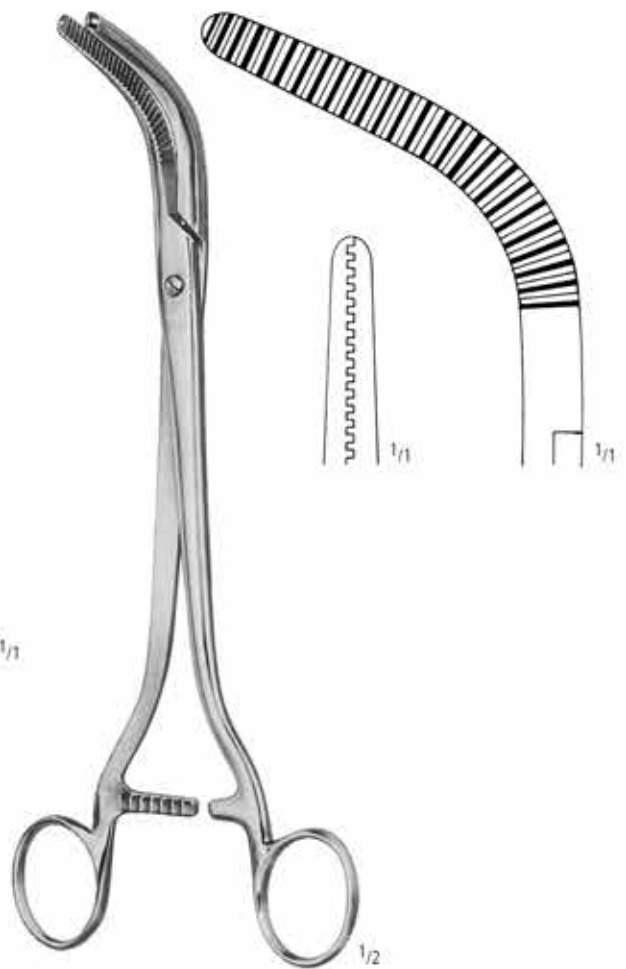

WERTHEIM
AA 500/27
 27,0 cm/10 3/4"

Hysterektomieklemmen
 Hysterectomy Forceps
 Pinzas-clamps para hysterectomia
 Pincas à hystérectomie
 Pinze per isterectomia

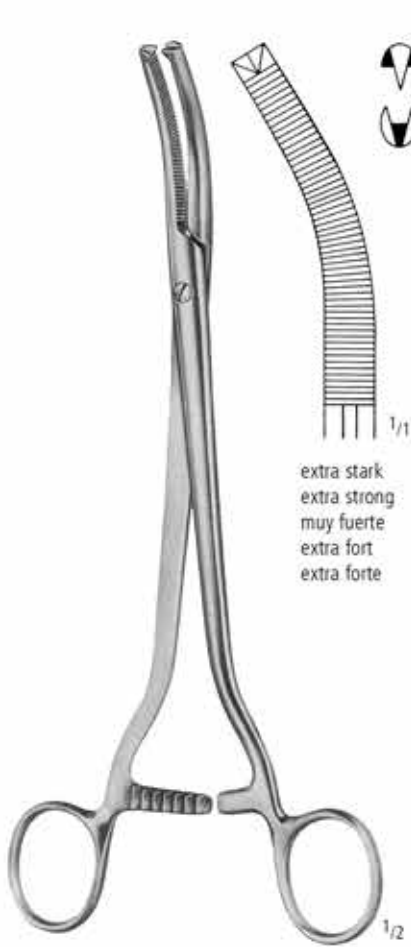

WERTHEIM 1:2
AA 501/24
 24,0 cm/9¹/₂"

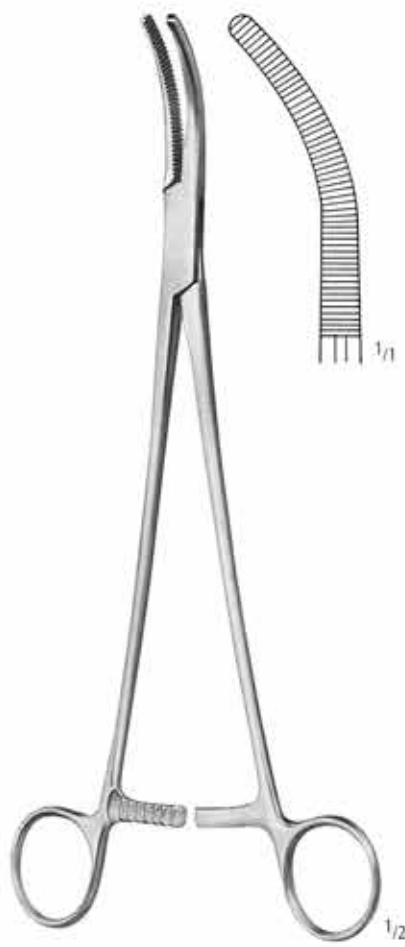

WERTHEIM
AA 502/25
 25,0 cm/10"

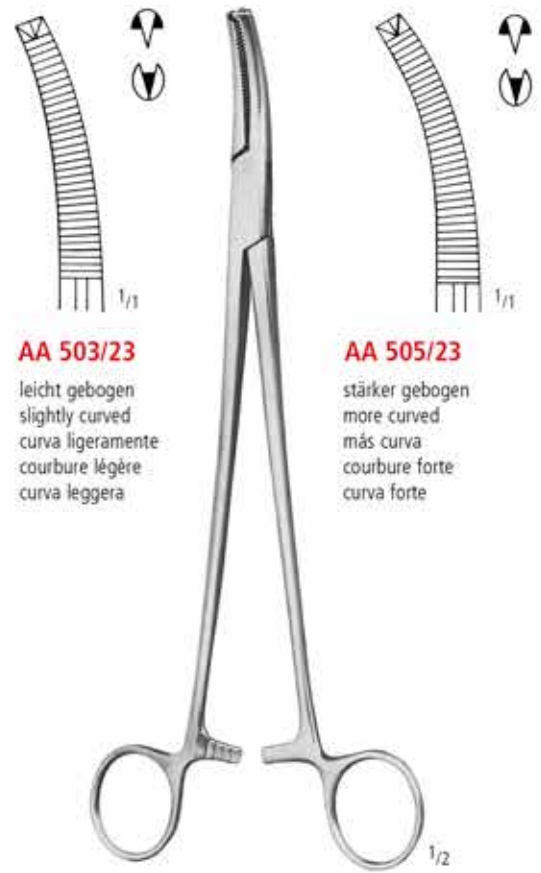

WERTHEIM 1:2
 23,0 cm/9"

Hysterektomieklemmen
Hysterectomy Forceps
Pinzas-clamps para histerectomía
Pincés à hystérectomie
Pinze per isterectomia

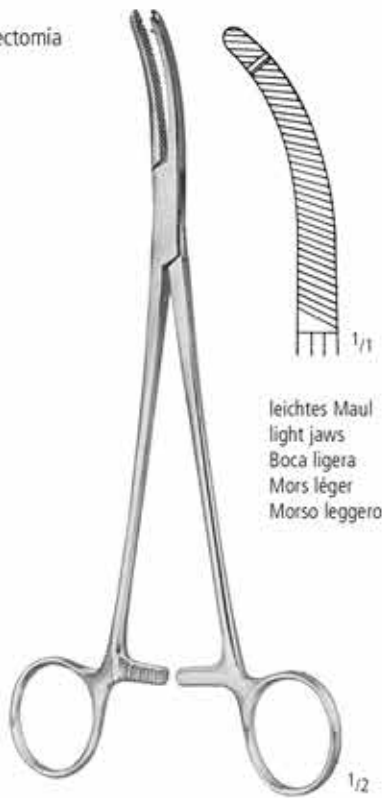

leichtes Maul
light jaws
Boca ligera
Mors léger
Morso leggero

HEANEY
AA 507/21
21,0 cm/8¹/₄"

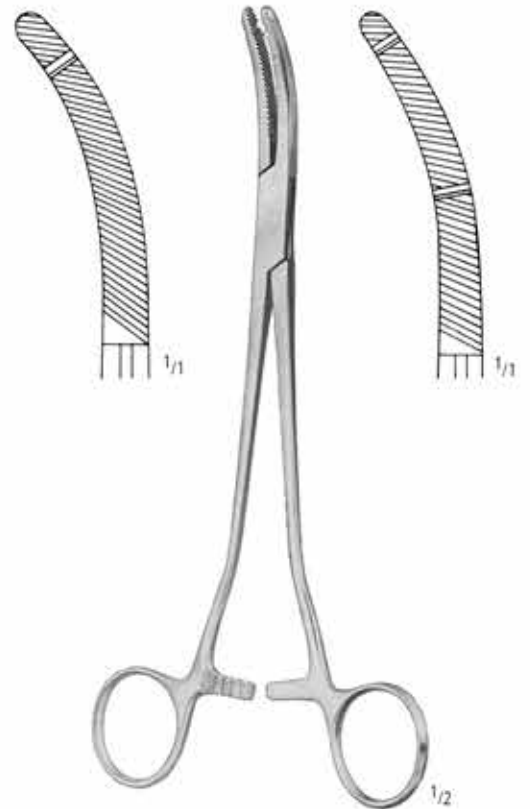

HEANEY
AA 511/21 21,0 cm/8¹/₄" **AA 513/21**
AA 511/23 23,0 cm/9" **AA 513/23**

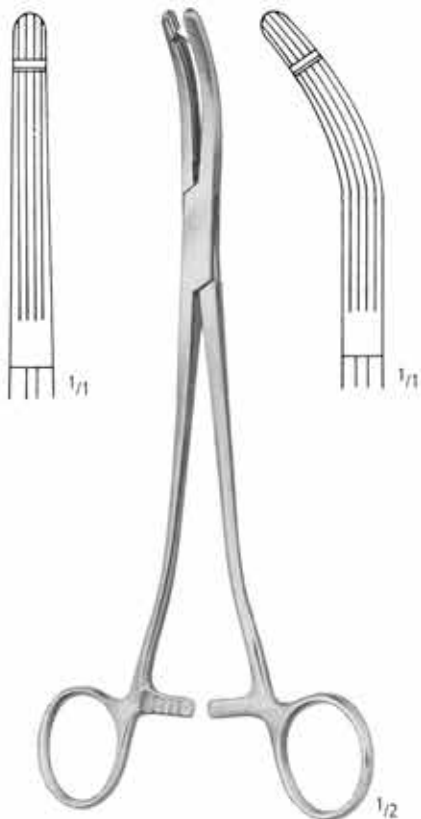

HEANEY-BALLANTINE
AA 514/21 21,0 cm/8¹/₄" **AA 515/21**

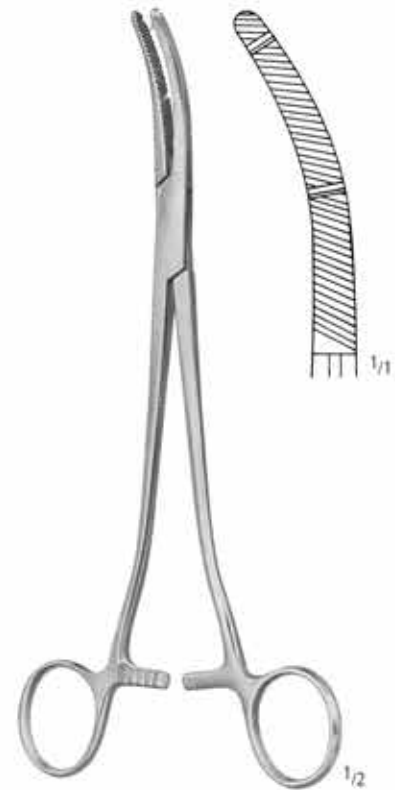

HEANEY-KANTER
AA 517/21
21,0 cm/8¹/₄"

AA

AB

AC

AD

AE

AF

AK

AL

AM

AO

AP

AR

KA

KD

KU

KV

Hysterektomieklemmen
 Hysterectomy Forceps
 Pinzas-clamps para histerectomia
 Pincès à hystérectomie
 Pinze per isterectomia

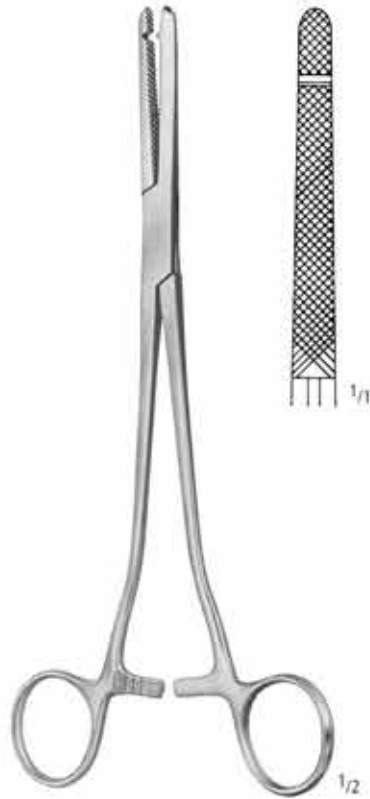

HEANEY-REZAK
AA 519/21
 21,0 cm/8¹/₄"

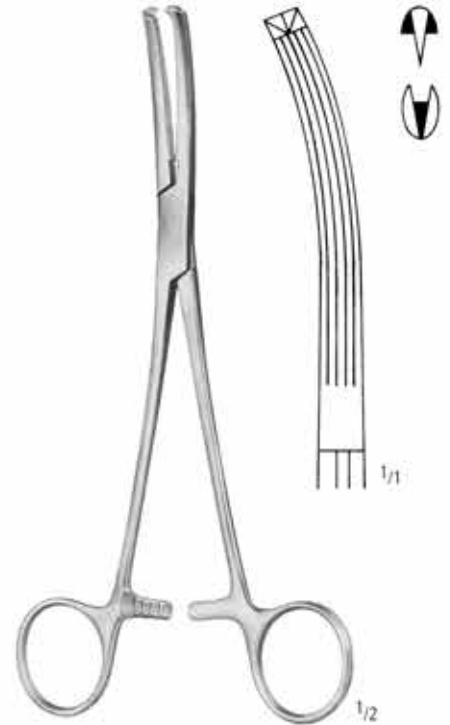

LONG
AA 521/19
 19,0 cm/7¹/₂"



MOYNIHAN

AA 525/23
 23,0 cm/9"

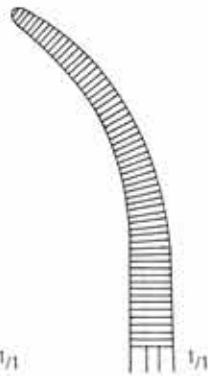

AA 527/24
 24,0 cm/9¹/₂"



WERTHEIM-CULLEN
AA 529/21
 21,5 cm/8¹/₂"

Hysterektomieklemmen
 Hysterectomy Forceps
 Pinzas-clamps para histerectomía
 Pincés à hystérectomie
 Pinze per isterectomia

AA
 AB
 AC
 AD
 AE
 AF
 AG
 AH
 AI
 AJ
 AK
 AL
 AM
 AN
 AO
 AP
 AQ
 AR
 AS
 AT
 AU
 AV
 AW
 AX
 AY
 AZ

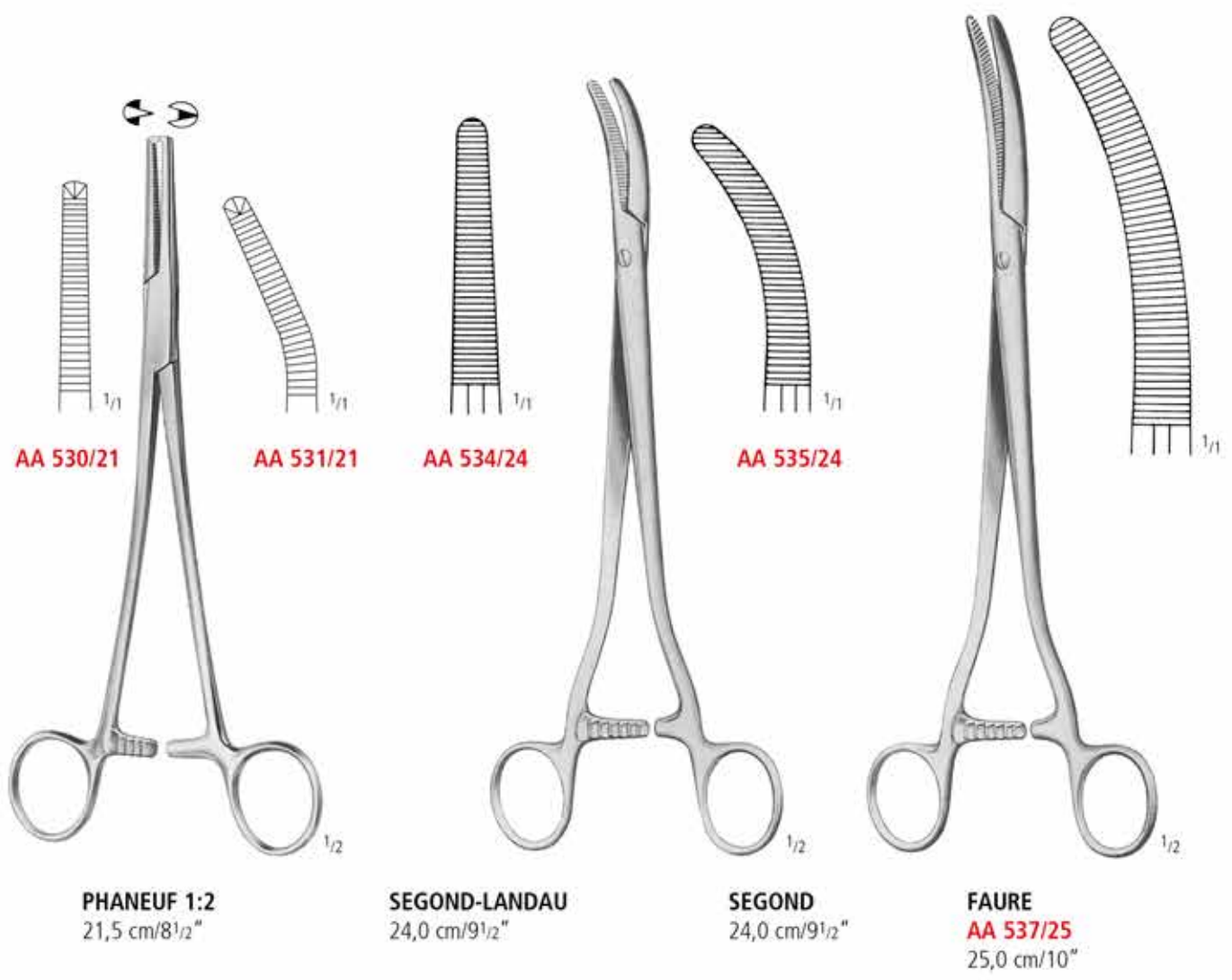

Parametriumklemmen
 Parametrium Forceps
 Pinzas-clamps para parametrium
 Pincas-clamps pour parametrium
 Pinze per parametrium



PARAMETRIUM
 21,0 cm/8 1/4"

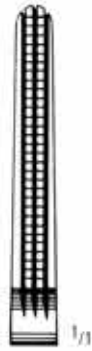

AA 540/00



AA 541/01



AA 541/02

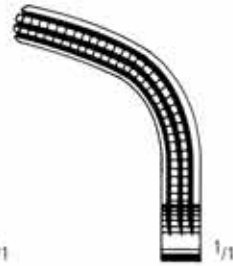

AA 541/03

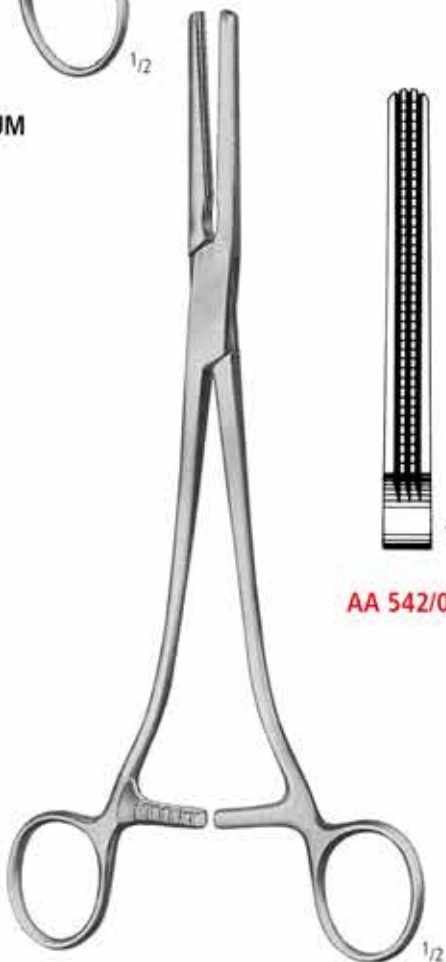

PARAMETRIUM
 24,0 cm/9 1/2"

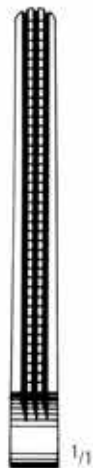

AA 542/00



AA 543/01

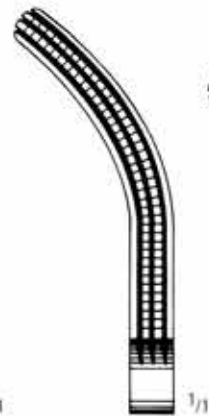

AA 543/02



AA 543/03

Druckklemmen, Hämorrhoidenklemmen
 Angiotribes, Haemorrhoidal Forceps
 Pinzas-clamps de presión progresiva, Pinzas hemorroidales
 Pincas-clamps à pression progressive et à hémorroïdes
 Pinze per pressione progressiva e per emorroidi

AA

AB

AC

AD

AE

AF

AK

AL

AM

AO

AP

AR

KA

KD

KU

KY

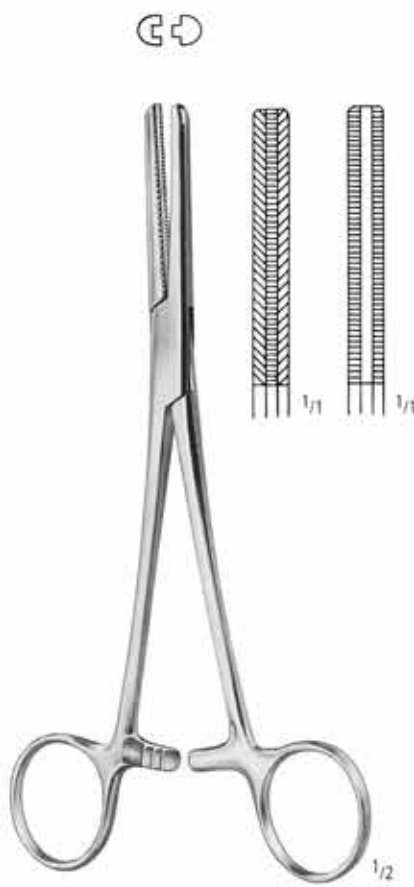

FERGUSSON
AA 550/16
AA 550/20

16,0 cm/6¹/₄"
 20,0 cm/8"

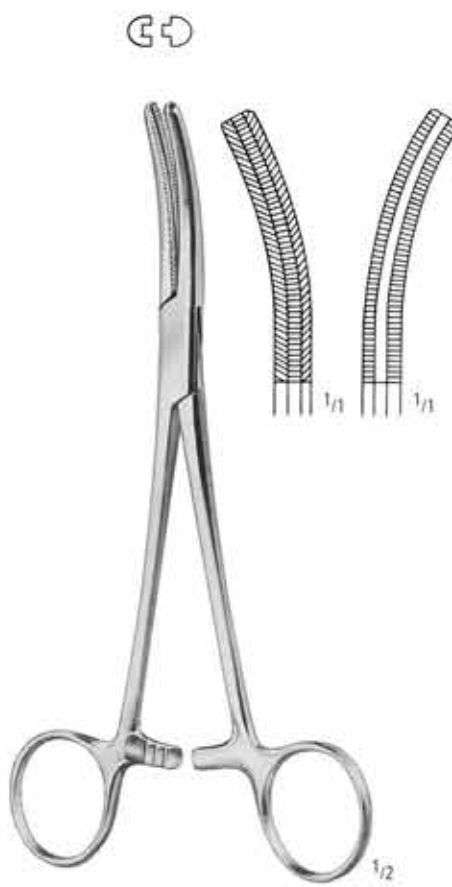

FERGUSSON
AA 551/16
AA 551/20



PRATT
AA 556/15
 15,0 cm/6"

Druckklemmen, Hämorrhoidenklemmen
 Angiotribes, Haemorrhoidal Forceps
 Pinzas-clamps de presión progresiva, Pinzas hemorroidales
 Pincers-clamps à pression progressive et à hémorroïdes
 Pinze per pressione progressiva e per emorroidi

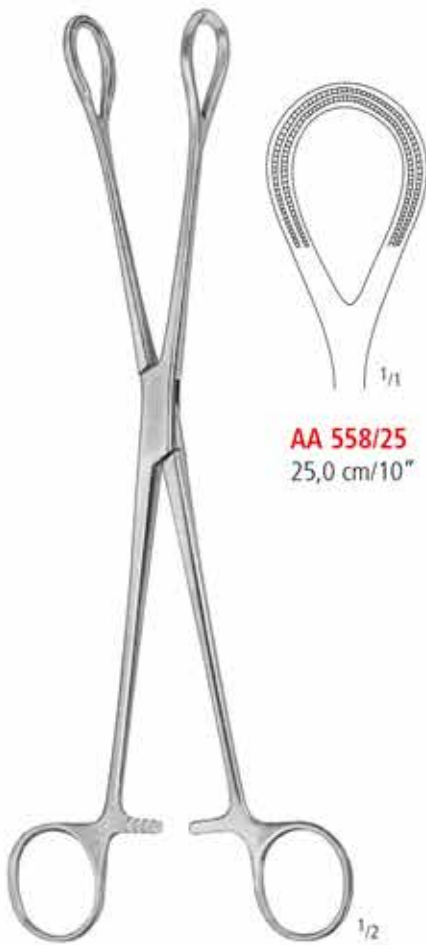

AA 558/25
 25,0 cm/10"



AA 558/27
 27,0 cm/10³/₄"

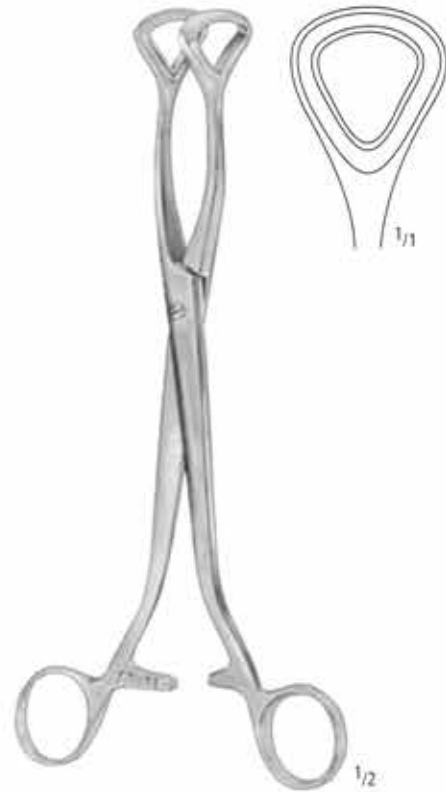

LUER
AA 560/24
 24,0 cm/9¹/₂"

Peritoneumklemmen
 Peritoneal Clamp Forceps
 Pinzas-clamps para peritoneo
 Pincas-clamps pour le péritoine
 Pinze per peritoneo

AA
 AB
 AC
 AD
 AE
 AF
 AG
 AH
 AI
 AJ
 AK
 AL
 AM
 AN
 AO
 AP
 AQ
 AR
 AS
 AT
 AU
 AV
 AW
 AX
 AY
 AZ



BABY-MIKULICZ 1:2
AA 601/14
 14,0 cm/5 1/2"

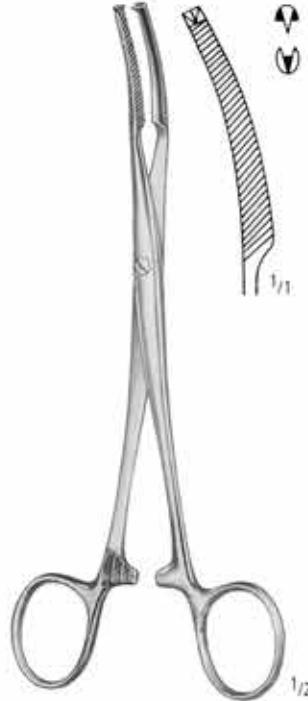

MIKULICZ 1:2
AA 603/18
 18,0 cm/7"



AA 605/20



AA 607/20

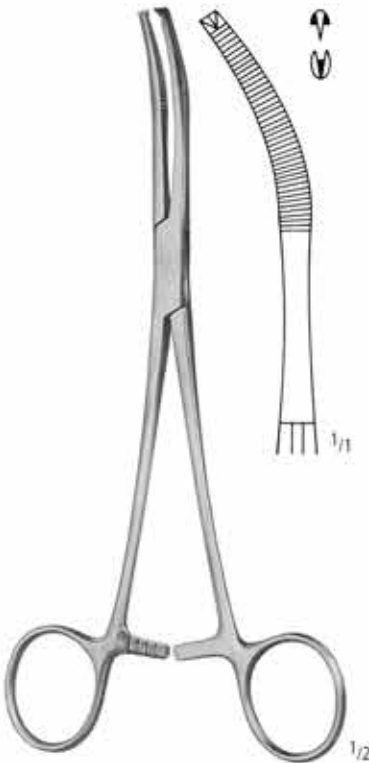

MIKULICZ 1:2
AA 609/20
 20,0 cm/8"

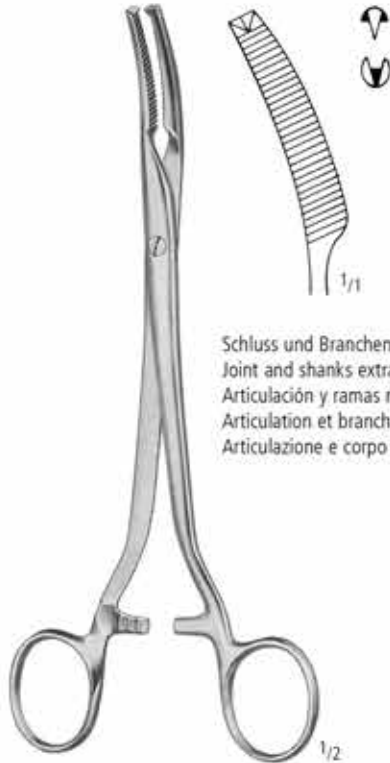

MIKULICZ 1:2
AA 611/20
 20,5 cm/8"

Schluss und Branchen extra stark
 Joint and shanks extra strong
 Articulación y ramas muy fuerte
 Articulation et branches très fortes
 Articolazione e corpo molto robusto

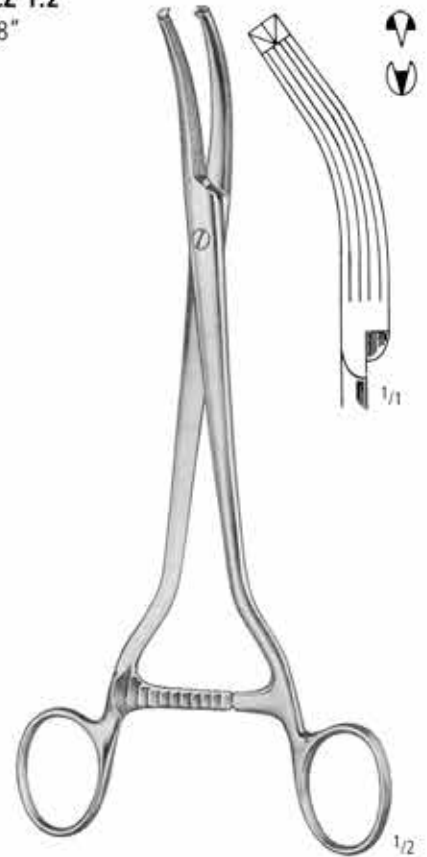

MIKULICZ 1:2
AA 613/23
 23,0 cm/9"

Peritoneumklemmen
 Peritoneal Clamp Forceps
 Pinzas-clamps para peritoneo
 Pinces-clamps pour le péritoine
 Pinze per peritoneo



AA 621/20
 leicht gebogen
 slightly curved
 curva ligeramente
 courbure légère
 curva leggera

FAURE 1:2
 20,0 cm/8"

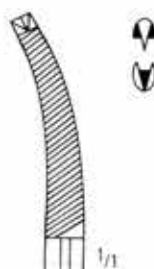

AA 623/20
 stärker gebogen
 more curved
 más curva
 courbure forte
 curva forte

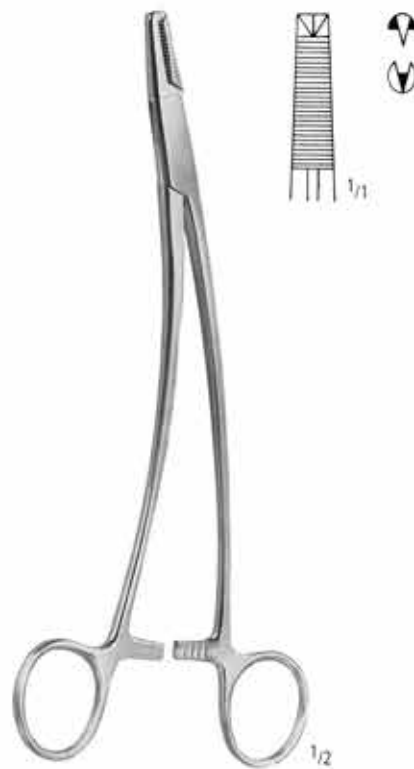

SCHINDLER 1:2
AA 625/20
 20,0 cm/8"

Tuchklemmen
Towel Forceps
Pinzas para compresas, Pinzas de campo
Pincès à champs, Pincès à compresses
Pinze per fissare le compresse (Fissatele)

AA

AB

AC

AD

AE

AF

AK

AL

AM

AO

AP

AR

KA

KD

KU

KY



SCHAEDEL
AA 710/09
9,0 cm/3 1/2"



JONES
5,0 cm/2"
9,0 cm/3 1/2"
AA 711/05
AA 711/09



ENGL. MODELL
AA 717/09
9,0 cm/3 1/2"



DOYEN
AA 721/18
18,0 cm/7"



BERNHARD
AA 726/16
16,5 cm/6 1/2"



LANE
15,0 cm/6"
18,0 cm/7"
20,0 cm/8"
AA 730/15
AA 730/18
AA 730/20

Tuchklemmen
Towel Forceps
Pinzas para compresas, Pinzas de campo
Pincés à champs, Pincés à compresses
Pinze per fissare le compresse (Fissatele)



AA 749/11

11,0 cm/4¹/₃"

- mit Schlauch- oder Kabelhalter
- with clip for tubing or cable
- con porta-tubo o porta-cable
- avec clamp porte-tube ou porte-corton d'alimentation
- con porta tubo o porta cavo



BACKHAUS

- 8,0 cm/3" **AA 751/08**
- 11,0 cm/4¹/₃" **AA 751/11**
- 13,0 cm/5" **AA 751/13**
- 15,0 cm/6" **AA 751/15**



BALL & SOCKET

- 11,0 cm/4¹/₃" **AA 753/11**
- 13,0 cm/5" **AA 753/13**

für Papiertücher
for paper tissues
para servilletas de papel
pour serviettes en papier
per tessuti di carta



ROEDER

- 13,0 cm/5" **AA 761/13**
- 15,0 cm/6" **AA 761/15**



LORNA

- 10,0 cm/4" **AA 763/10**
- 13,0 cm/5" **AA 763/13**

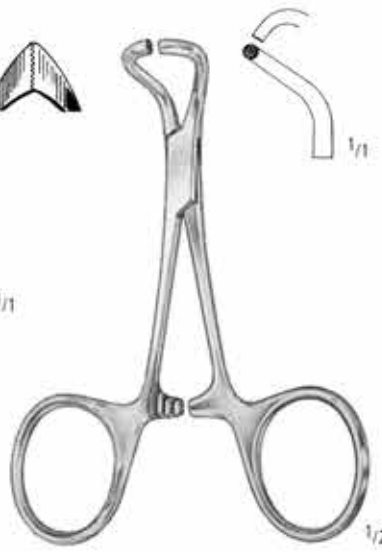

TOHOKU-JAPAN

- 10,0 cm/4" **AA 764/10**
- 13,0 cm/5" **AA 764/13**

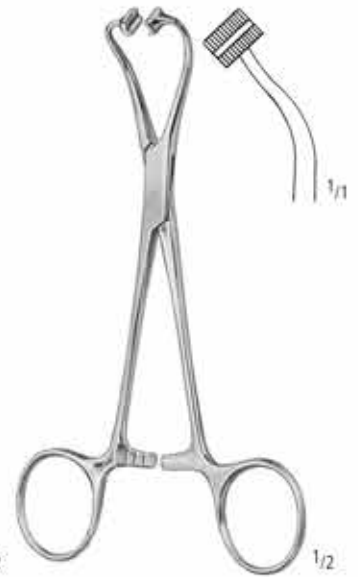

PEERS

- AA 765/14**
- 14,5 cm/5³/₄"

Schlauchklemmen
Tubing Clamps
Pinzas para tubos
Presses-tube
Pinze serratubi

AA
AB
AC
AD
AE
AF
AG
AH
AI
AJ
AK
AL
AM
AN
AO
AP
AQ
AR
AS
AT
AU
AV
AW
AX
AY
AZ
BA
BB
BC
BD
BE
BF
BG
BH
BI
BJ
BK
BL
BM
BN
BO
BP
BQ
BR
BS
BT
BU
BV
BW
BX
BY
BZ
CA
CB
CC
CD
CE
CF
CG
CH
CI
CJ
CK
CL
CM
CN
CO
CP
CQ
CR
CS
CT
CU
CV
CW
CX
CY
CZ
DA
DB
DC
DD
DE
DF
DG
DH
DI
DJ
DK
DL
DM
DN
DO
DP
DQ
DR
DS
DT
DU
DV
DW
DX
DY
DZ
EA
EB
EC
ED
EE
EF
EG
EH
EI
EJ
EK
EL
EM
EN
EO
EP
EQ
ER
ES
ET
EU
EV
EW
EX
EY
EZ
FA
FB
FC
FD
FE
FF
FG
FH
FI
FJ
FK
FL
FM
FN
FO
FP
FQ
FR
FS
FT
FU
FV
FW
FX
FY
FZ
GA
GB
GC
GD
GE
GF
GG
GH
GI
GJ
GK
GL
GM
GN
GO
GP
GQ
GR
GS
GT
GU
GV
GW
GX
GY
GZ
HA
HB
HC
HD
HE
HF
HG
HH
HI
HJ
HK
HL
HM
HN
HO
HP
HQ
HR
HS
HT
HU
HV
HW
HX
HY
HZ
IA
IB
IC
ID
IE
IF
IG
IH
II
IJ
IK
IL
IM
IN
IO
IP
IQ
IR
IS
IT
IU
IV
IW
IX
IY
IZ
JA
JB
JC
JD
JE
JF
JG
JH
JI
JJ
JK
JL
JM
JN
JO
JP
JQ
JR
JS
JT
JU
JV
JW
JX
JY
JZ
KA
KB
KC
KD
KE
KF
KG
KH
KI
KJ
KK
KL
KM
KN
KO
KP
KQ
KR
KS
KT
KU
KV
KW
KX
KY
KZ
LA
LB
LC
LD
LE
LF
LG
LH
LI
LJ
LK
LL
LM
LN
LO
LP
LQ
LR
LS
LT
LU
LV
LW
LX
LY
LZ
MA
MB
MC
MD
ME
MF
MG
MH
MI
MJ
MK
ML
MM
MN
MO
MP
MQ
MR
MS
MT
MU
MV
MW
MX
MY
MZ
NA
NB
NC
ND
NE
NF
NG
NH
NI
NJ
NK
NL
NM
NN
NO
NP
NQ
NR
NS
NT
NU
NV
NW
NX
NY
NZ
OA
OB
OC
OD
OE
OF
OG
OH
OI
OJ
OK
OL
OM
ON
OO
OP
OQ
OR
OS
OT
OU
OV
OW
OX
OY
OZ
PA
PB
PC
PD
PE
PF
PG
PH
PI
PJ
PK
PL
PM
PN
PO
PP
PQ
PR
PS
PT
PU
PV
PW
PX
PY
PZ
QA
QB
QC
QD
QE
QF
QG
QH
QI
QJ
QK
QL
QM
QN
QO
QP
QQ
QR
QS
QT
QU
QV
QW
QX
QY
QZ
RA
RB
RC
RD
RE
RF
RG
RH
RI
RJ
RK
RL
RM
RN
RO
RP
RQ
RR
RS
RT
RU
RV
RW
RX
RY
RZ
SA
SB
SC
SD
SE
SF
SG
SH
SI
SJ
SK
SL
SM
SN
SO
SP
SQ
SR
SS
ST
SU
SV
SW
SX
SY
SZ
TA
TB
TC
TD
TE
TF
TG
TH
TI
TJ
TK
TL
TM
TN
TO
TP
TQ
TR
TS
TT
TU
TV
TW
TX
TY
TZ
UA
UB
UC
UD
UE
UF
UG
UH
UI
UJ
UK
UL
UM
UN
UO
UP
UQ
UR
US
UT
UU
UV
UW
UX
UY
UZ
VA
VB
VC
VD
VE
VF
VG
VH
VI
VJ
VK
VL
VM
VN
VO
VP
VQ
VR
VS
VT
VU
VV
VW
VX
VY
VZ
WA
WB
WC
WD
WE
WF
WG
WH
WI
WJ
WK
WL
WM
WN
WO
WP
WQ
WR
WS
WT
WU
WV
WW
WX
WY
WZ
XA
XB
XC
XD
XE
XF
XG
XH
XI
XJ
XK
XL
XM
XN
XO
XP
XQ
XR
XS
XT
XU
XV
XW
XX
XY
XZ
YA
YB
YC
YD
YE
YF
YG
YH
YI
YJ
YK
YL
YM
YN
YO
YP
YQ
YR
YS
YT
YU
YV
YW
YX
YY
YZ
ZA
ZB
ZC
ZD
ZE
ZF
ZG
ZH
ZI
ZJ
ZK
ZL
ZM
ZN
ZO
ZP
ZQ
ZR
ZS
ZT
ZU
ZV
ZW
ZX
ZY
ZZ

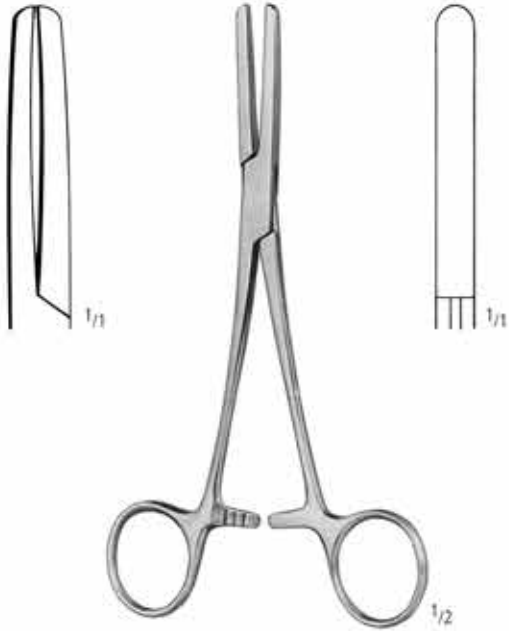

PRESBYTERIAN
16,5 cm/6¹/₂" **AA 790/16**
18,0 cm/7" **AA 790/18**

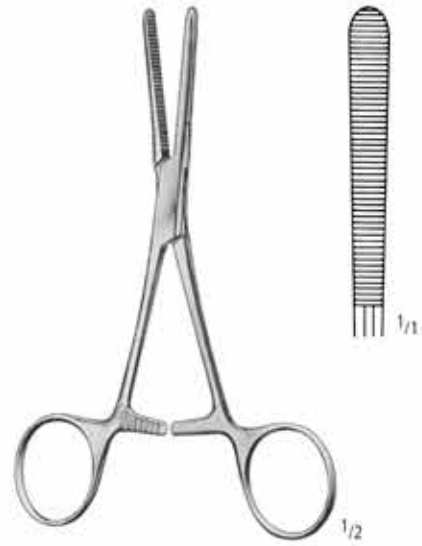

KLINIKUM BERLIN
AA 792/14
14,5 cm/5³/₄"
mit langer Sperre
with long ratchet
con cremallera larga
à crémaillère extra longue
con cremagliera extra lunga



AA 794/15 **AA 794/18** **AA 794/20**

AA 794/15 15,5 cm/6"
AA 794/18 18,0 cm/7"
AA 794/20 20,0 cm/8"

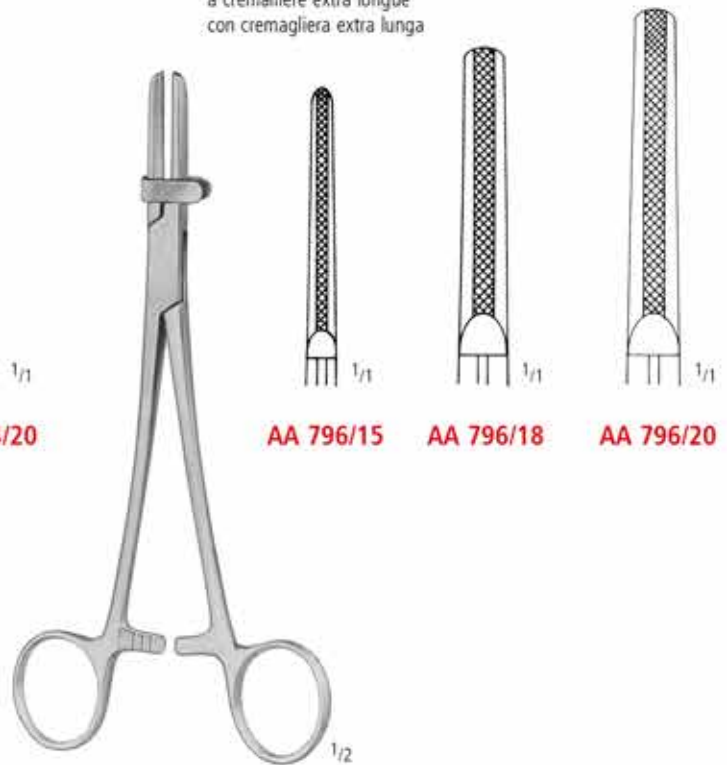

AA 796/15 **AA 796/18** **AA 796/20**

AA 796/15
AA 796/18
AA 796/20

PINZETTEN
FORCEPS
PINZAS
PINCES
PINZE

AB

nopa[®] instruments



PINZETTEN FORCEPS PINZAS PINCES PINZE

Anatomische Pinzetten, Chirurgische Pinzetten
 Dressing Forceps, Tissue Forceps
 Pinzas de disección, Pinzas de disección con dientes
 Pincers à dissection, Pincers à griffes
 Pinze anatomiche per dissezione, Pinze chirurgiche a denti di topo



STANDARD ^{1/2}



AB 050/10
10,5 cm/4¹/₄"



AB 050/11
11,5 cm/4¹/₂"



AB 050/13
13,0 cm/5"



AB 050/14
14,5 cm/5³/₄"

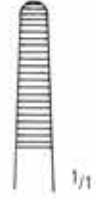

AB 050/16
16,0 cm/6¹/₄"



AB 050/18
18,0 cm/7"



AB 050/20
20,0 cm/8"



AB 050/25
25,0 cm/10"



AB 050/30
30,0 cm/12"



AB 050/36
36,0 cm/14"



STANDARD 1:2 ^{1/2}



AB 060/10
10,5 cm/4¹/₄"



AB 060/11
11,5 cm/4¹/₂"



AB 060/13
13,0 cm/5"



AB 060/14
14,5 cm/5³/₄"



AB 060/16
16,0 cm/6¹/₄"



AB 060/18
18,0 cm/7"



AB 060/20
20,0 cm/8"



AB 060/25
25,0 cm/10"



AB 060/30
30,0 cm/12"



AB 060/36
36,0 cm/14"

AA
 AB
 AC
 AD
 AE
 AF
 AG
 AH
 AI
 AJ
 AK
 AL
 AM
 AN
 AO
 AP
 AQ
 AR
 AS
 AT
 AU
 AV
 AW
 AX
 AY
 AZ

AB PINZETTEN FORCEPS PINZAS PINCES PINZE

Anatomische Pinzetten, Chirurgische Pinzetten
 Dressing Forceps, Tissue Forceps
 Pinzas de disección, Pinzas de disección con dientes
 Pincès à dissection, Pincès à griffes
 Pinze anatomiche per dissezione, Pinze chirurgiche a denti di topo



AB 062/14



AB 064/14



AB 066/14

- 2:3**
 13,0 cm/5"
 14,5 cm/5³/₄"
 16,0 cm/6¹/₄"
 18,0 cm/7"
 20,0 cm/8"
 25,0 cm/10"
 30,0 cm/12"

- AB 062/13**
AB 062/14
AB 062/16
AB 062/18
AB 062/20
AB 062/25
AB 062/30

- 3:4**
AB 064/13
AB 064/14
AB 064/16

- 4:5**
AB 066/13
AB 066/14
AB 066/16



AB 070/13



AB 071/13



AB 080/14



AB 081/14



AB 083/14



AB 084/14



1/2

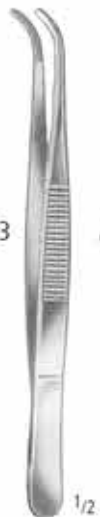

1/2



1/2



1/2



1/2



1/2

schmal - narrow - estrechas - étroites - strette

- | | | | | |
|---|------------------|------------------|------------------|------------------|
| 10,5 cm/4 ¹ / ₄ " | AB 070/10 | AB 071/10 | AB 080/10 | AB 081/10 |
| 11,5 cm/4 ¹ / ₂ " | AB 070/11 | AB 071/11 | AB 080/11 | AB 081/11 |
| 13,0 cm/5" | AB 070/13 | AB 071/13 | AB 080/13 | AB 081/13 |
| 14,5 cm/5 ³ / ₄ " | AB 070/14 | AB 071/14 | AB 080/14 | AB 081/14 |
| 16,0 cm/6 ¹ / ₄ " | AB 070/16 | AB 071/16 | AB 080/16 | AB 081/16 |
| 18,0 cm/7" | AB 070/18 | AB 071/18 | AB 080/18 | AB 081/18 |
| 20,0 cm/8" | AB 070/20 | AB 071/20 | AB 080/20 | AB 081/20 |
| 23,0 cm/9" | AB 070/23 | | AB 080/23 | |
| 25,0 cm/10" | AB 070/25 | AB 071/25 | AB 080/25 | AB 081/25 |
| 30,0 cm/12" | AB 070/30 | AB 071/30 | AB 080/30 | AB 081/30 |

fein - delicate - finas - fines - fine

- | | |
|------------------|------------------|
| AB 083/13 | AB 084/13 |
| AB 083/14 | AB 084/14 |

PINZETTEN FORCEPS PINZAS PINCES PINZE

Anatomische Pinzetten, Chirurgische Pinzetten
 Dressing Forceps, Tissue Forceps
 Pinzas de disección, Pinzas de disección con dientes
 Pincés à dissection, Pincés à griffes
 Pinze anatomiche per dissezione, Pinze chirurgiche a denti di topo

MODELL USA

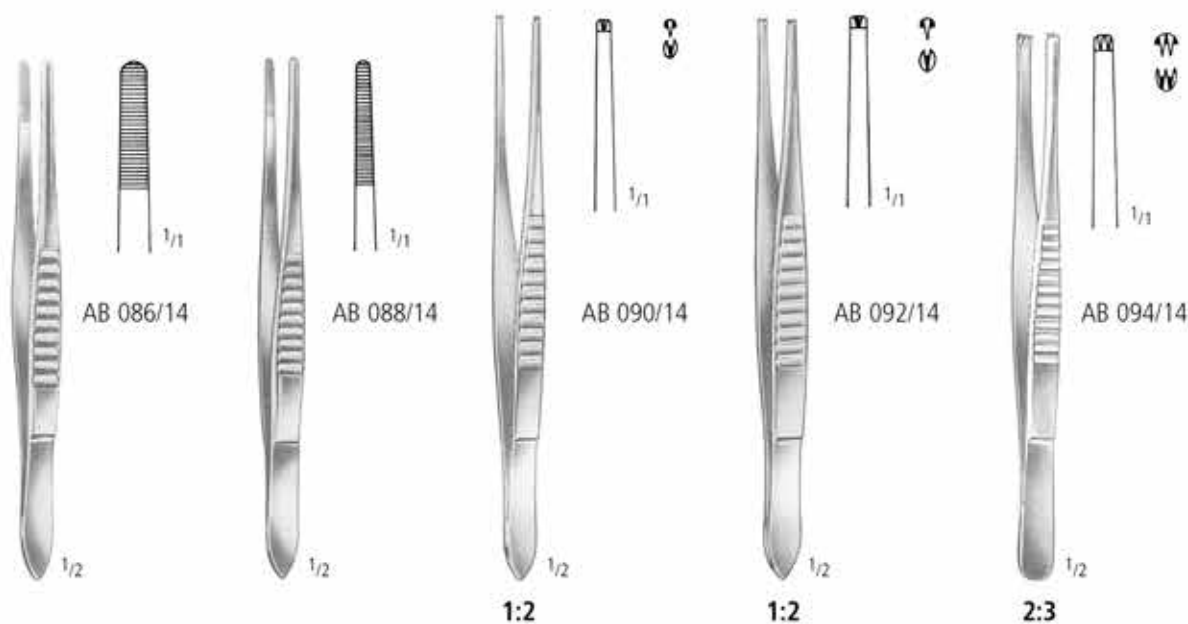

schmal - narrow - estrechas - étroites - strette

12,0 cm/4 ³ / ₄ "	AB 086/12	AB 088/12		AB 092/12	AB 094/12
13,0 cm/5"	AB 086/13	AB 088/13	AB 090/13	AB 092/13	AB 094/13
14,5 cm/5 ³ / ₄ "	AB 086/14	AB 088/14	AB 090/14	AB 092/14	AB 094/14
15,5 cm/6"	AB 086/15	AB 088/15	AB 090/15	AB 092/15	AB 094/15
18,0 cm/7"	AB 086/18			AB 092/18	AB 094/18
21,0 cm/8 ¹ / ₄ "	AB 086/21			AB 092/21	AB 094/21
25,0 cm/10"	AB 086/25			AB 092/25	AB 094/25
31,0 cm/12 ¹ / ₄ "	AB 086/31			AB 092/31	AB 094/31

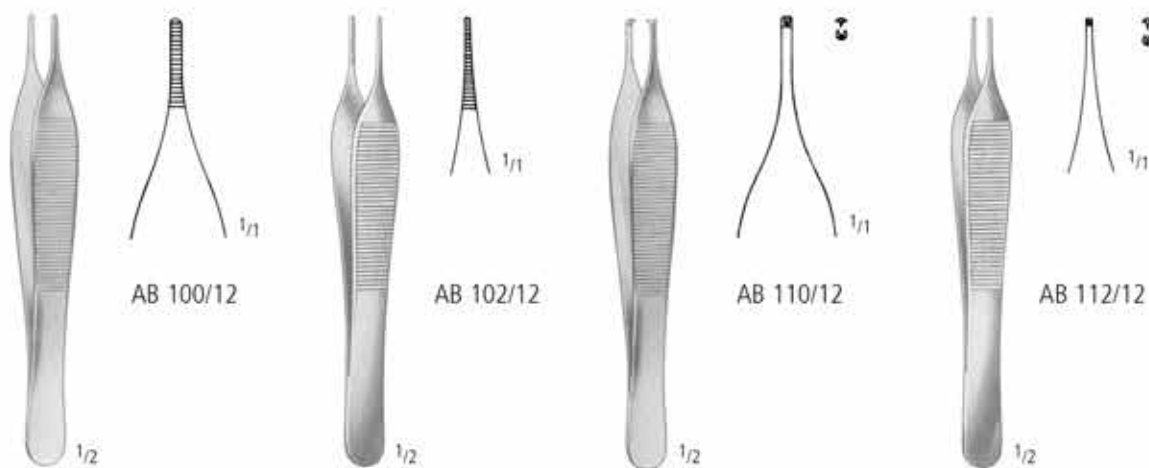

12,0 cm/4 ³ / ₄ "	ADSON	MICRO-ADSON	ADSON 1:2	MICRO-ADSON 1:2
15,0 cm/6"	AB 100/12	AB 102/12	AB 110/12	AB 112/12
	AB 100/15	AB 102/15	AB 110/15	AB 112/15

AA
 AB
 AC
 AD
 AE
 AF
 AG
 AH
 AI
 AJ
 AK
 AL
 AM
 AN
 AO
 AP
 AQ
 AR
 AS
 AT
 AU
 AV
 AW
 AX
 AY
 AZ

AB PINZETTEN FORCEPS PINZAS PINCES PINZE

Anatomische Pinzetten, Chirurgische Pinzetten
 Dressing Forceps, Tissue Forceps
 Pinzas de disección, Pinzas de disección con dientes
 Pincés à dissection, Pincés à griffes
 Pinze anatomiche per dissezione, Pinze chirurgiche a denti di topo

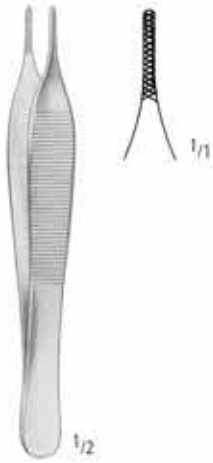

ADSON
AB 114/12
 12,0 cm/4³/₄"

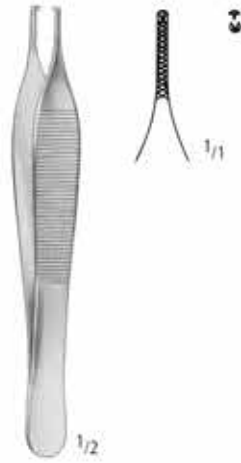

ADSON 1:2
AB 115/12
 12,0 cm/4³/₄"



7 : 7
AB 116/07

9 : 9
AB 116/09



9 : 9

ADSON-BROWN
 12,0 cm/4³/₄"

ADSON-BROWN
AB 117/09
 12,0 cm/4³/₄"

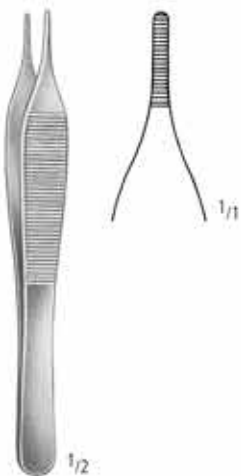

EWALD
AB 118/01
 12,0 cm/4³/₄"

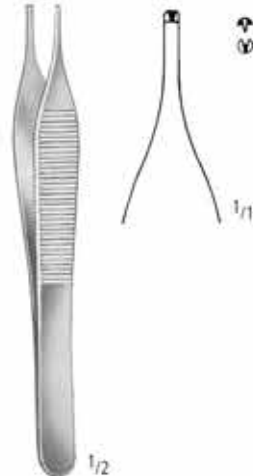

EWALD 1:2
AB 118/02
 12,0 cm/4³/₄"



McINDOE
AB 119/15
 15,0 cm/6"

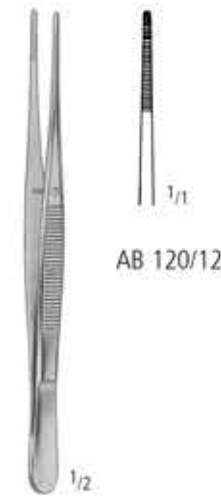

AB 120/12

AB 120/12
AB 120/15

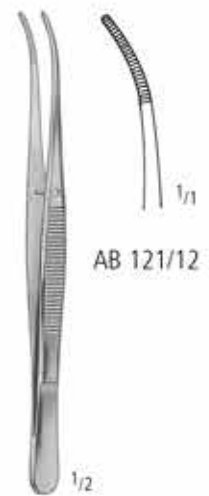

AB 121/12

AB 121/12
AB 121/15

SEMKEN
 12,5 cm/5"
 15,5 cm/6"

PINZETTEN FORCEPS PINZAS PINCES PINZE

Anatomische Pinzetten, Chirurgische Pinzetten
 Dressing Forceps, Tissue Forceps
 Pinzas de disección, Pinzas de disección con dientes
 Pincers à dissection, Pincers à griffes
 Pinze anatomiche per dissezione, Pinze chirurgiche a denti di topo

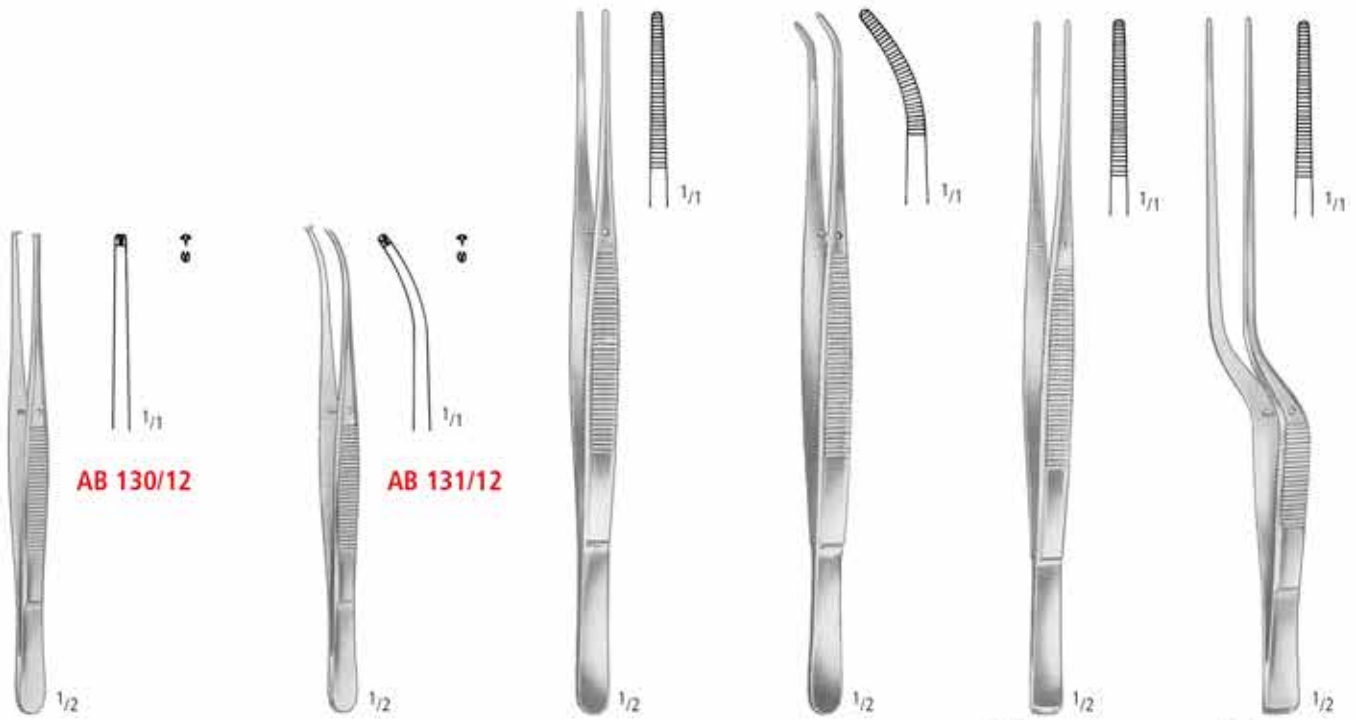

AB 130/12 AB 130/15	SEMKEN 1:2 12,5 cm/5" 15,5 cm/6"	AB 131/12 AB 131/15	TAYLOR AB 140/17 17,5 cm/7"	TAYLOR AB 141/17 17,5 cm/7"	TAYLOR AB 142/17 17,5 cm/7"	TAYLOR AB 143/17 17,5 cm/7"
--------------------------------------	---	--------------------------------------	---	---	---	---

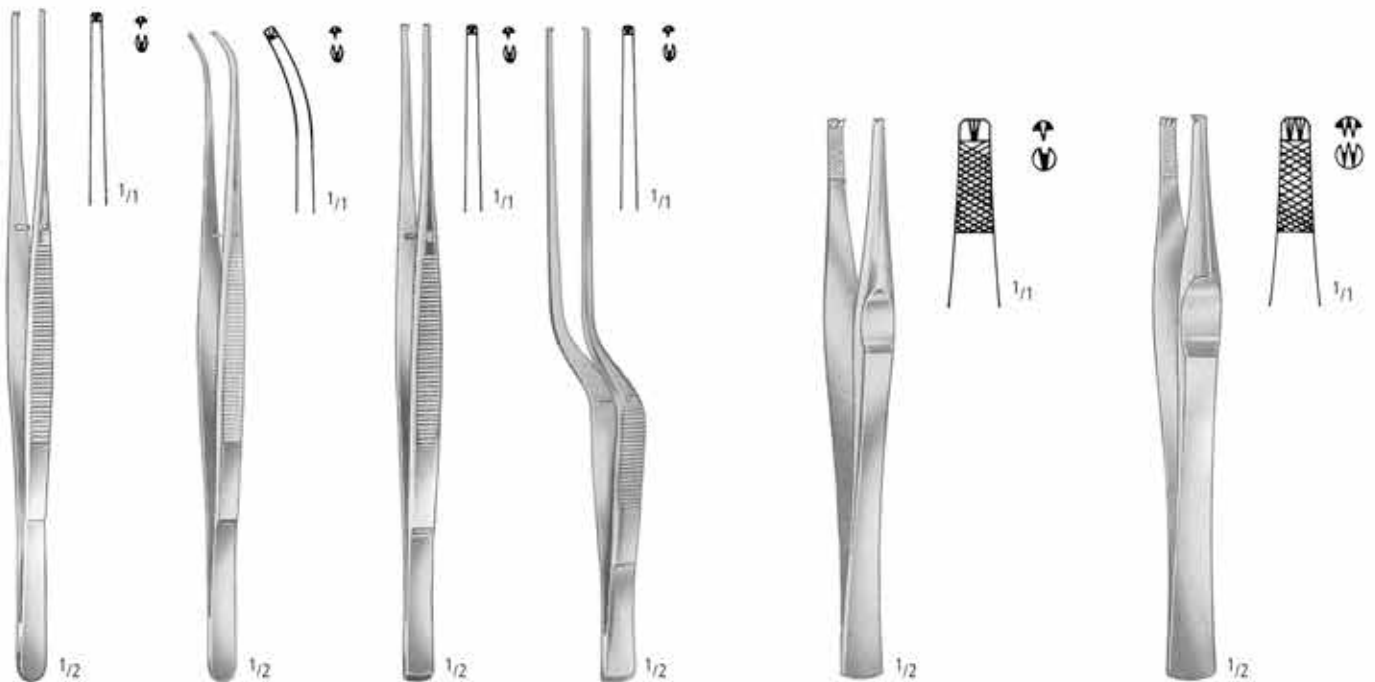

TAYLOR 1:2 AB 150/17 17,5 cm/7"	TAYLOR 1:2 AB 151/17 17,5 cm/7"	TAYLOR 1:2 AB 152/17 17,5 cm/7"	TAYLOR 1:2 AB 153/17 17,5 cm/7"	LANE 1:2 AB 156/14 14,5 cm/5 ³ / ₄ " AB 156/20 20,0 cm/8"	LANE 2:3 AB 158/14 AB 158/20
---	---	---	---	--	---

AA
 AB
 AC
 AD
 AE
 AF
 AG
 AH
 AI
 AJ
 AK
 AL
 AM
 AN
 AO
 AP
 AQ
 AR
 AS
 AT
 AU
 AV
 AW
 AX
 AY
 AZ

AB PINZETTEN FORCEPS PINZAS PINCES PINZE

Anatomische Pinzetten, Chirurgische Pinzetten
 Dressing Forceps, Tissue Forceps
 Pinzas de disección, Pinzas de disección con dientes
 Pincés à dissection, Pincés à griffes
 Pinze anatomiche per dissezione, Pinze chirurgiche a denti di topo



GERALD
AB 160/18 18,0 cm/7"



GERALD
AB 161/18



GERALD 1:2
AB 170/18 18,0 cm/7"



GERALD 1:2
AB 171/18



CUSHING
AB 180/17 17,5 cm/7"



CUSHING
AB 181/17



CUSHING 1:2
AB 190/17 17,5 cm/7"



CUSHING 1:2
AB 191/17

PINZETTEN FORCEPS PINZAS PINCES PINZE

Anatomische Pinzetten, Chirurgische Pinzetten
 Dressing Forceps, Tissue Forceps
 Pinzas de disección, Pinzas de disección con dientes
 Pincés à dissection, Pincés à griffes
 Pinze anatomiche per dissezione, Pinze chirurgiche a denti di topo



AB 200/18

POTTS-SMITH



AB 201/18



AB 210/18

**POTTS-SMITH
1:2**

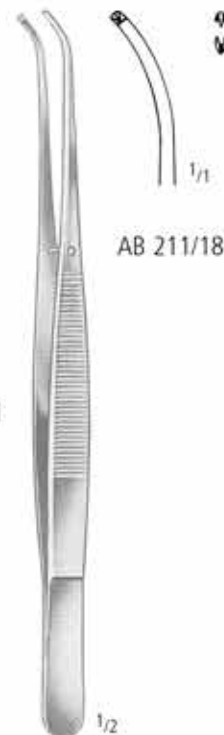

AB 211/18

18,0 cm/7"
 21,0 cm/8¹/₄"
 25,0 cm/10"

AB 200/18
AB 200/21
AB 200/25

AB 201/18
AB 201/21
AB 201/25

AB 210/18
AB 210/21
AB 210/25

AB 211/18
AB 211/21
AB 211/25



BROPHY



AB 251/20



**BROPHY
1:2**

AB 260/20



AB 261/20

20,0 cm/8"

AB 250/20

AA
AB
 AC
 AD
 AE
 AF
 AK
 AL
 AM
 AO
 AP
 AR
 KA
 KD
 KU
 KY

AB PINZETTEN FORCEPS PINZAS PINCES PINZE

Anatomische Pinzetten, Chirurgische Pinzetten
 Dressing Forceps, Tissue Forceps
 Pinzas de disección, Pinzas de disección con dientes
 Pincés à dissection, Pincés à griffes
 Pinze anatomiche per dissezione, Pinze chirurgiche a denti di topo

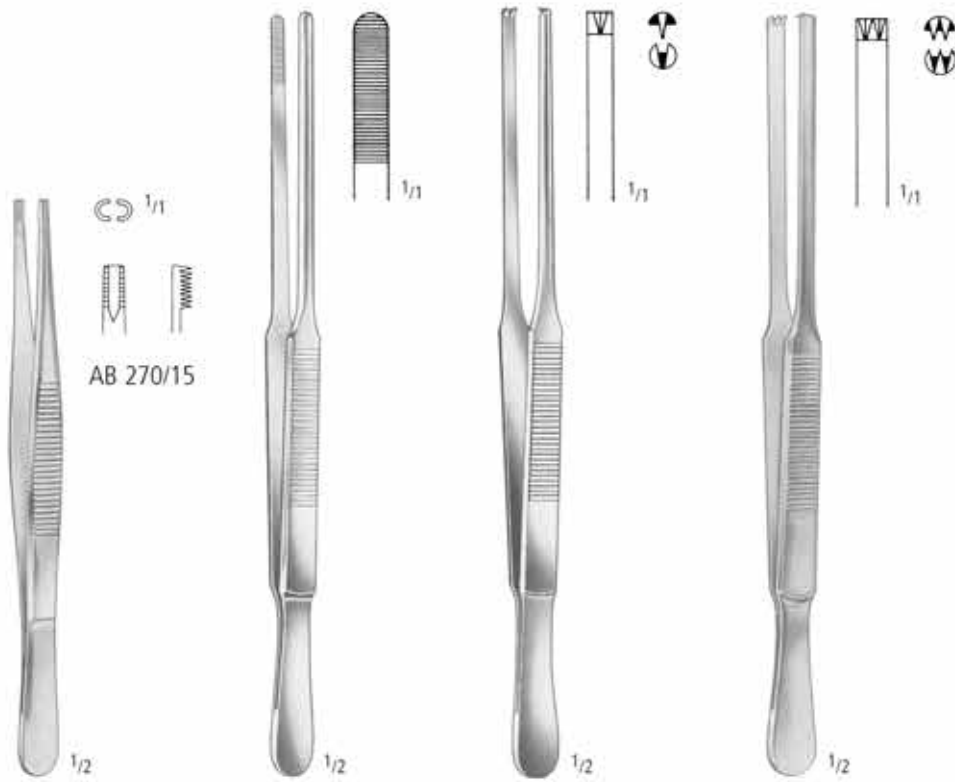

15,0 cm/6"
 20,0 cm/8"
 25,0 cm/10"

BROWN
AB 270/15
AB 270/20
AB 270/25

DUEHRSSSEN
AB 290/20

DUEHRSSSEN 1:2
AB 292/20

DUEHRSSSEN 2:3
AB 294/20

PINZETTEN FORCEPS PINZAS PINCES PINZE

Anatomische Pinzetten, Chirurgische Pinzetten
 Dressing Forceps, Tissue Forceps
 Pinzas de disección, Pinzas de disección con dientes
 Pincés à dissection, Pincés à griffes
 Pinze anatomiche per dissezione, Pinze chirurgiche a denti di topo



WANGENSTEEN
AB 306/23
 23,0 cm/9"



STILLE-BARRAYA 3:4
AB 316/18
AB 316/20
AB 316/25
 18,0 cm/7"
 20,0 cm/8"
 25,0 cm/10"

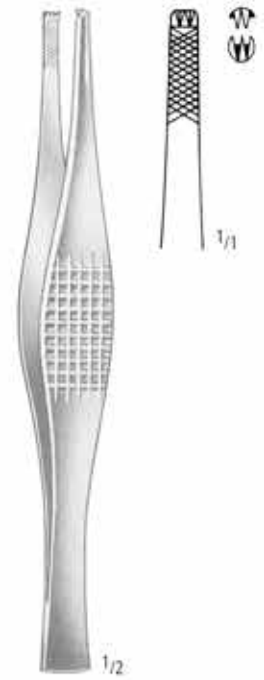

FERRIS-SMITH 2:3
AB 320/18
 18,0 cm/7"

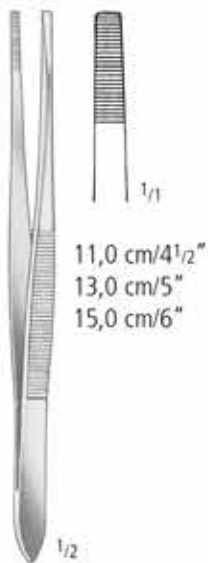

STILLE
AB 370/11
AB 370/13
AB 370/15



STILLE 1:2
AB 380/15
 15,0 cm/6"



STILLE 2:3
AB 382/15
 15,0 cm/6"



ADLERKREUTZ

AB 400/15
AB 400/20
 15,0 cm/6"
 20,0 cm/8"
 25,0 cm/10"

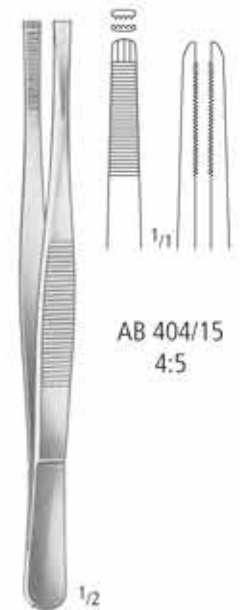

AB 404/15
AB 404/20
AB 404/25
 4:5

AA
AB
 AC
 AD
 AE
 AF
 AG
 AH
 AI
 AJ
 AK
 AL
 AM
 AN
 AO
 AP
 AQ
 AR
 AS
 AT
 AU
 AV
 AW
 AX
 AY
 AZ

AB PINZETTEN FORCEPS PINZAS PINCES PINZE

Fasspinzetten
Grasping Forceps
Pinzas para coger
Pinces pour saisir les tissus
Pinze per afferrare tessuti

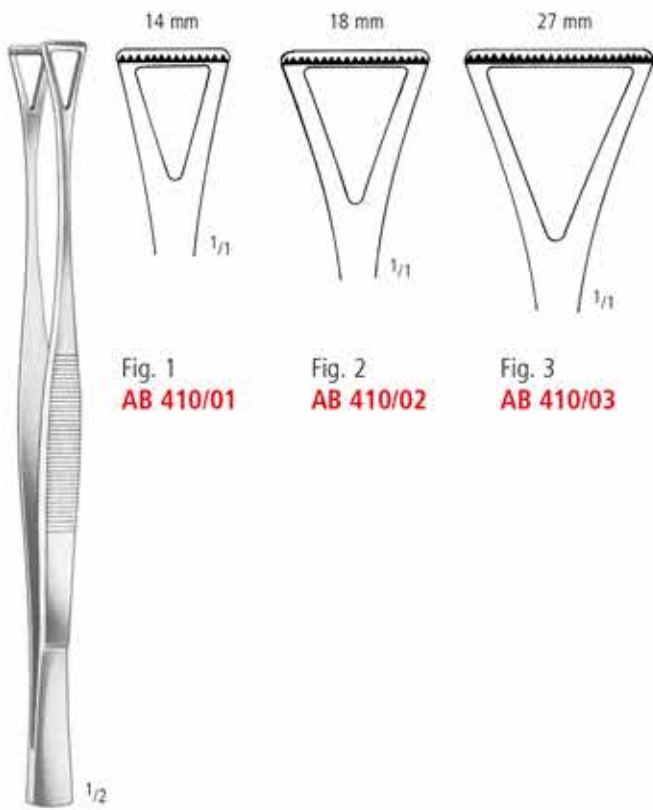
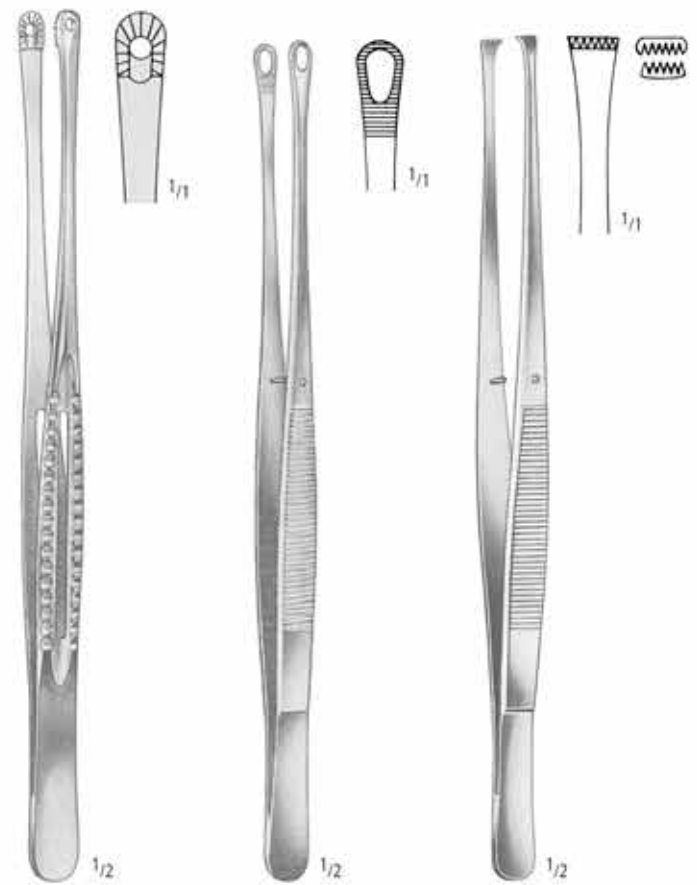

Fig. 1
AB 410/01

Fig. 2
AB 410/02

Fig. 3
AB 410/03



MAYO-RUSS.
AB 414/23
23,0 cm/9"

SINGLEY-TUTTLE
AB 416/23
23,0 cm/9"

NELSON
AB 418/23
23,0 cm/9"

COLLIN-DUVAL
20,0 cm/8"

PINZETTEN FORCEPS PINZAS PINCES PINZE

Chirurgische Pinzetten, Fasspinzetten
 Tissue Forceps, Grasping Forceps
 Pinzas de disección con dientes, Pinzas para coger
 Pincés à griffes, Pincés pour saisir les tissus
 Pinze chirurgiche a denti di topo, Pinze per afferrare tessuti



GILLIES 1:2
AB 430/15
 15,0 cm/6"



WAUGH 1:2
AB 434/20
 20,5 cm/8"



AB 440/10
 10,5 cm/4 1/4"



AB 441/10

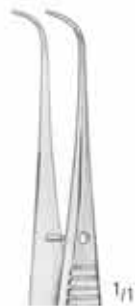

AB 443/10



1:2
AB 444/10
 10,5 cm/4 1/4"



AB 445/10



AB 447/10

AA

AB

AC

AD

AE

AF

AK

AL

AM

AO

AP

AR

KA

KD

KU

KY

AB PINZETTEN FORCEPS PINZAS PINCES PINZE

Chirurgische Pinzetten, Fasspinzetten
 Tissue Forceps, Grasping Forceps
 Pinzas de disección con dientes, Pinzas para coger
 Pincés à griffes, Pincés pour saisir les tissus
 Pinze chirurgiche a denti di topo, Pinze per afferrare tessuti



AB 480/15



AB 484/16

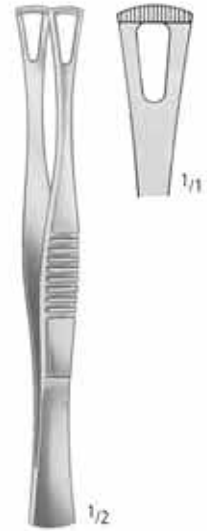

DUVAL
AB 486/14
 14,5 cm/5³/₄"

RUSS. MODELL

- 15,0 cm/6" **AB 480/15**
- 20,0 cm/8" **AB 480/20**
- 25,0 cm/10" **AB 480/25**

DURANTE

- 14,5 cm/5³/₄" **AB 484/14**
- 16,0 cm/6¹/₄" **AB 484/16**
- 20,0 cm/8" **AB 484/20**

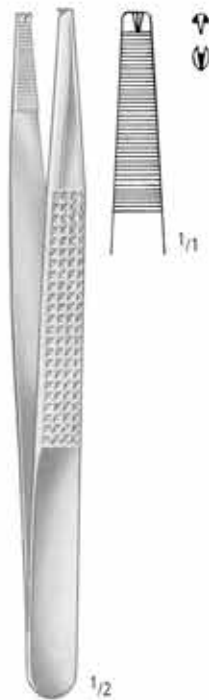

BONNEY 1:2
AB 490/18
 18,0 cm/7"

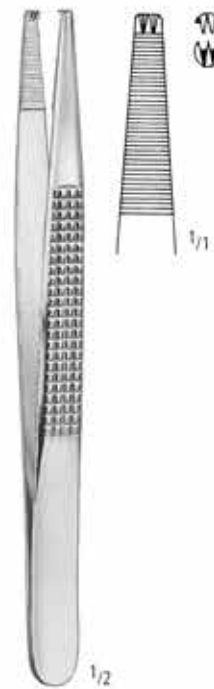

BONNEY 2:3
AB 492/18
 18,0 cm/7"

PINZETTEN FORCEPS PINZAS PINCES PINZE

Uhrmacherpinzetten
Jeweler's Forceps
Pinzas de relojero
Pincés d'horloger
Pinze da orologiaio

	1/1	No. 1	AB 501/01 12,0 cm/4 ³ / ₄ "	AA
	1/1	No. 2	AB 501/02 12,0 cm/4 ³ / ₄ "	AB
	1/1	No. 3	AB 501/03 12,0 cm/4 ³ / ₄ "	AC
	1/1	No. 4	AB 501/04 11,0 cm/4 ¹ / ₃ "	AD
	1/1	No. 5	AB 501/05 11,0 cm/4 ¹ / ₃ "	AE
	1/1	No. 5a	AB 501/15 11,0 cm/4 ¹ / ₃ "	AF
	1/1	No. 5/45°	AB 501/45 10,5 cm/4 ¹ / ₄ "	AK
	1/1	No. 5/90°	AB 501/90 10,5 cm/4 ¹ / ₄ "	AL
	1/1	No. 7	AB 502/07 11,5 cm/4 ¹ / ₂ "	AM

AB PINZETTEN FORCEPS PINZAS PINCES PINZE

Fasspinzetten
Grasping Forceps
Pinzas para coger
Pincers pour saisir les tissus
Pinze per afferrare tessuti



AB 506/01 Ø 3,0 mm
AB 506/02 Ø 3,0 mm

SAMII
24,0 cm/9 1/2"



AB 507/01 Ø 3,0 mm
AB 507/02 Ø 5,0 mm
Löffel
Spoon

AB 508/01 Ø 3,0 mm
AB 508/02 Ø 5,0 mm
flach
flat

22,0 cm/8 3/4"



AB 509/01 Ø 3,0 mm
AB 509/02 Ø 5,0 mm
Kürette
Curette

HEIFETZ
22,0 cm/8 3/4"



HUNT
AB 510/20
20,0 cm/8"



16,0 cm/6 1/4"
18,0 cm/7"
20,0 cm/8"
22,0 cm/8 3/4"
24,0 cm/9 1/2"

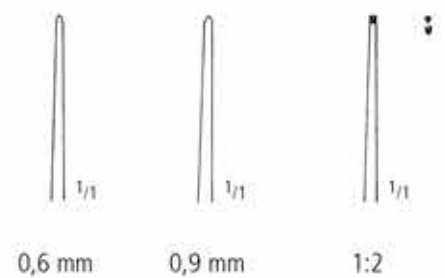

AB 515/16 **AB 516/16** **AB 517/16**
AB 515/18 **AB 516/18** **AB 517/18**
AB 515/20 **AB 516/20** **AB 517/20**
AB 515/22 **AB 516/22**
AB 515/24 **AB 516/24**

PINZETTEN FORCEPS PINZAS PINCES PINZE

Mikro-Pinzetten, Knüpfpinzetten mit Plateau
 Micro Forceps, Suture Tying Forceps with platform
 Micro-Pinzas, Pinzas de ligadura con plataforma
 Micro-Pinces, Pinces à ligature avec plate-forme
 Micro-Pinze, Pinze per ligature con piattaforma

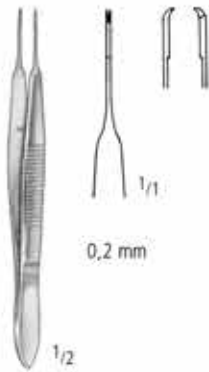

1:2
AB 530/09
 9,5 cm/3³/₄"

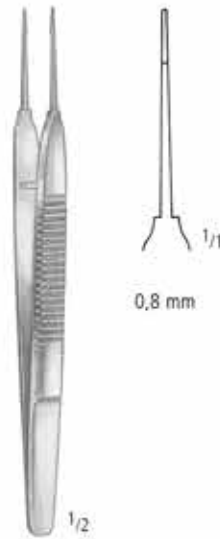

AUSTIN
AB 532/14
 14,0 cm/5¹/₂"

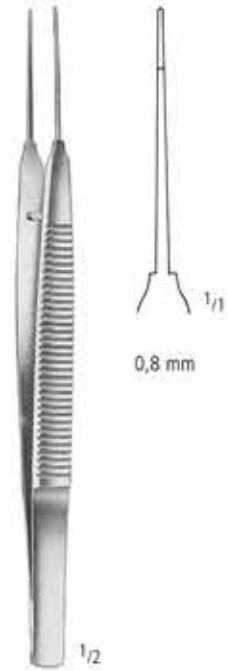

AUSTIN
AB 532/18
 18,0 cm/7"

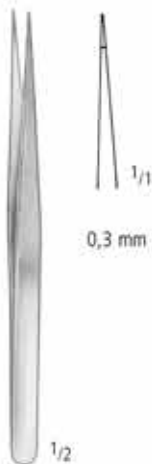

AB 534/12
 12,0 cm/4³/₄"



VISE
AB 534/13
 13,5 cm/5¹/₄"

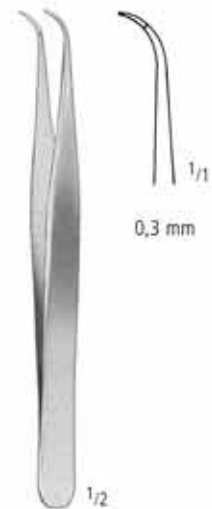

VISE
AB 535/13
 13,5 cm/5¹/₄"

AA

AB

AC

AD

AE

AF

AK

AL

AM

AO

AP

AR

KA

KD

KU

KY

AB PINZETTEN FORCEPS PINZAS PINCES PINZE

Mikro-Pinzetten, Knüpfpinzetten mit Plateau, Gefäßdilator
 Micro Forceps, Suture Tying Forceps with platform, Vessel Dilator
 Micro-Pinzas, Pinzas de ligadura con plataforma, Dilatador para vasos
 Micro-Pinces, Pinces à ligature avec plate-forme, Dilatateur pour vaisseaux
 Micro-Pinze, Pinze per ligature con piattaforma, Dilatatore per vasi



AB 536/14
 14,0 cm/5 1/2"



AB 538/14 1:2
 14,0 cm/5 1/2"



AB 540/14 1:2
 14,0 cm/5 1/2"

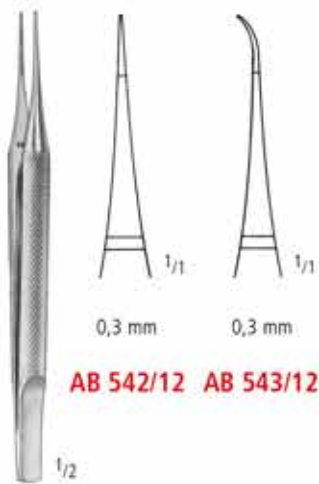

AB 542/12 **AB 543/12**

12,0 cm/4 3/4" **AB 542/12** **AB 543/12**
 15,0 cm/6" **AB 542/15** **AB 543/15**



AB 544/18 **AB 545/18**

18,0 cm/7"

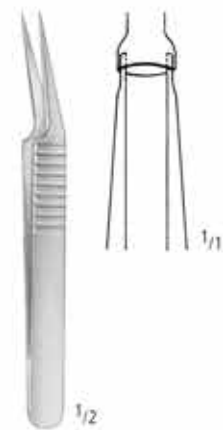

AB 546/11
 11,0 cm/4 1/3"

PINZETTEN FORCEPS PINZAS PINCES PINZE

Splitter-Pinzetten
 Splinter Forceps
 Pinzas para espigas
 Pincès à échardes
 Pinze per schegge



AB 550/11

FEILCHENFELD

- 7,5 cm/3" **AB 550/07**
- 9,0 cm/3 1/2" **AB 550/09**
- 11,5 cm/4 1/2" **AB 550/11**

ohne Führungsstift
 without guide pin
 sin espiga de guía
 sans repères
 senza perno da guida

- 8,0 cm/3"
- 9,0 cm/3 1/2"
- 10,5 cm/4 1/4"
- 11,5 cm/4 1/2"
- 12,5 cm/5"
- 14,5 cm/5 3/4"



HUNTER
AB 552/10
 10,5 cm/4 1/4"



HUNTER
AB 553/10
 10,5 cm/4 1/4"



WALTER-CARMALT
AB 556/10
 10,5 cm/4 1/4"



WALTER-CARMALT
AB 557/10
 10,5 cm/4 1/4"



AB 560/10

- AB 560/08**
- AB 560/09**
- AB 560/10**
- AB 560/11**
- AB 560/12**
- AB 560/14**



AB 561/10

- AB 561/08**
- AB 561/09**
- AB 561/10**
- AB 561/11**
- AB 561/12**
- AB 561/14**



AB 562/10

- AB 562/08**
- AB 562/09**
- AB 562/10**
- AB 562/11**
- AB 562/12**
- AB 562/14**



AB 563/10

- AB 563/08**
- AB 563/09**
- AB 563/10**
- AB 563/11**
- AB 563/12**
- AB 563/14**



AA
AB
 AC
 AD
 AE
 AF
 AG
 AH
 AI
 AJ
 AK
 AL
 AM
 AN
 AO
 AP
 AR
 AS
 AT
 AU
 AV
 AW
 AX
 AY
 AZ

AB PINZETTEN FORCEPS PINZAS PINCES PINZE

Splitter-Pinzetten
 Splinter Forceps
 Pinzas para espigas
 Pincès à échardes
 Pinze per schegge

mit Führungsstift
 with guide pin
 con espiga de guía
 avec repères
 con perno da guida



AB 564/10



AB 565/10



AB 566/10



AB 567/10

- 8,0 cm/3"
- 9,0 cm/3 1/2"
- 10,5 cm/4 1/4"
- 11,5 cm/4 1/2"
- 12,5 cm/5"
- 14,5 cm/5 3/4"

- AB 564/08**
- AB 564/09**
- AB 564/10**
- AB 564/11**
- AB 564/12**
- AB 564/14**

- AB 565/08**
- AB 565/09**
- AB 565/10**
- AB 565/11**
- AB 565/12**
- AB 565/14**

- AB 566/08**
- AB 566/09**
- AB 566/10**
- AB 566/11**
- AB 566/12**
- AB 566/14**

- AB 567/08**
- AB 567/09**
- AB 567/10**
- AB 567/11**
- AB 567/12**
- AB 567/14**

PINZETTEN FORCEPS PINZAS PINCES PINZE

Splitter-Pinzetten
 Splinter Forceps
 Pinzas para espinas
 Pincès à échardes
 Pinze per schegge

AA

AB

AC

AD

AE

AF

AK

AL

AM

AO

AP

AR

KA

KD

KU

KY

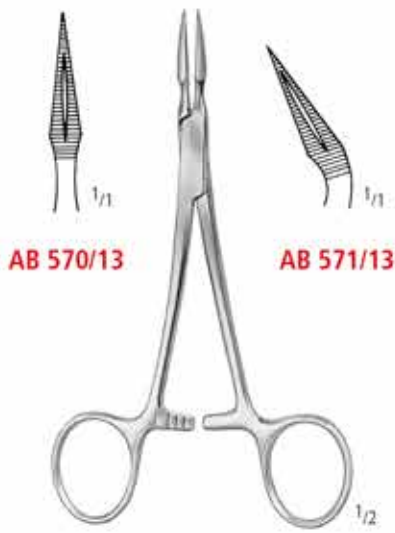

AB 570/13

AB 571/13

STIEGLITZ
 13,5 cm/5 1/4"



STIEGLITZ
AB 571/90
 13,5 cm/5 1/4"

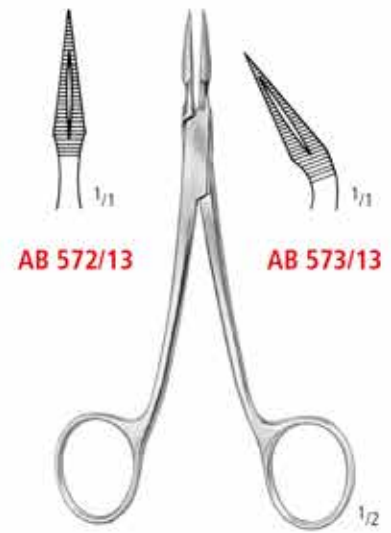

AB 572/13

AB 573/13

STIEGLITZ
 13,5 cm/5 1/4"



PEET
AB 580/11
 11,5 cm/4 1/2"

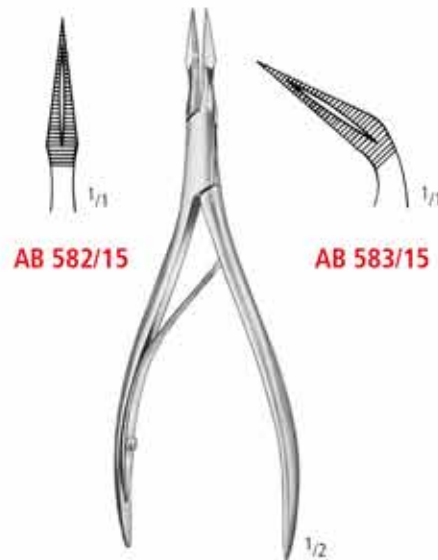

AB 582/15

AB 583/15

RALK
 15,0 cm/6"

AB PINZETTEN FORCEPS PINZAS PINCES PINZE

Cilienpinzetten
Cilia Forceps
Pinzas depilatorias
Pinces à épiler les cils
Pinze depilatorie



LITTAUER
AB 620/08
8,5 cm/3¹/₃"



AB 621/09
9,0 cm/3¹/₂"



DOUGLAS
AB 624/09
9,0 cm/3¹/₂"



BEER
AB 626/09
9,0 cm/3¹/₂"



ZIEGLER
AB 628/09
9,0 cm/3¹/₂"



BARRAQUER
AB 633/10
10,5 cm/4¹/₄"



GRADLE
AB 635/09
9,5 cm/3³/₄"

PINZETTEN FORCEPS PINZAS PINCES PINZE

Ohr- und Nasenpinzetten
 Ear and Nose Dressing Forceps
 Pinzas auriculares y nasales
 Pincès auriculaires et nasales
 Pinze auricolare e nasale



TROELTSCH (WILDE)

- AB 650/11
- AB 650/12
- AB 650/15
- AB 650/18

- 11,0 cm/4¹/₃"
- 12,0 cm/4³/₄"
- 15,0 cm/6"
- 18,0 cm/7"



TROELTSCH (WILDE) 1:2

- AB 652/12
- AB 652/15
- AB 652/18

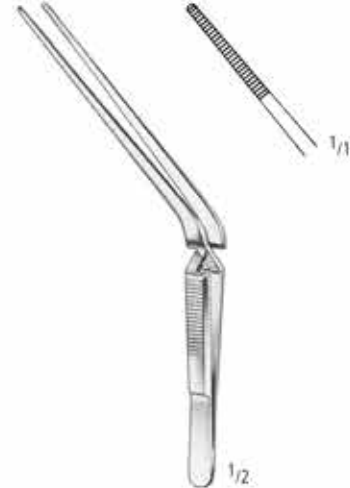

TROELTSCH (WILDE)

Mod. Jalasvirta

- AB 654/11
- 11,0 cm/4¹/₃"

- AB 654/13
- 13,0 cm/5"



LUCAE

- AB 656/14
- 14,0 cm/5¹/₂"

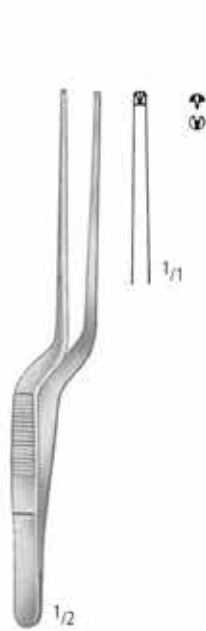

LUCAE 1:2

- AB 658/14
- 14,0 cm/5¹/₂"



JANSEN

- 16,0 cm/6¹/₄"
- 18,0 cm/7"
- 20,0 cm/8"
- AB 660/16
- AB 660/18
- AB 660/20

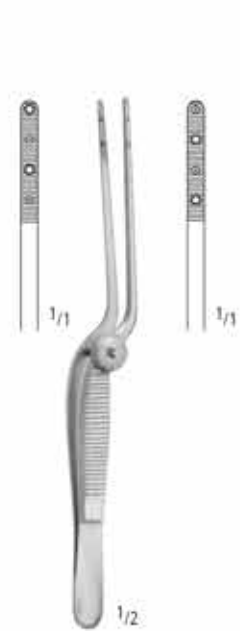

COTTLE

- AB 665/14
- 14,0 cm/5¹/₂"

AA
 AB
 AC
 AD
 AE
 AF
 AG
 AH
 AI
 AJ
 AK
 AL
 AM
 AN
 AO
 AP
 AQ
 AR
 AS
 AT
 AU
 AV
 AW
 AX
 AY
 AZ

AB PINZETTEN FORCEPS PINZAS PINCES PINZE

Tampon-, Nasen- und Deckglaspinzetten
 Dressing-, Tampon-, Nasal- and Cover Glass Forceps
 Pinzas para compresas, tamponamientos, nasales y pinzas porta-laminillas
 Pincés à pansements, nasales et pincés porte-lamelles
 Pinze per tamponi e medicazione, nasali e pinze porta-lamelle



GRUENWALD (JANSEN)
AB 690/20
 20,0 cm/8"



GRUENWALD 1:2
AB 692/20
 20,0 cm/8"



AB 695/22

AB 697/22



KUEHNE
AB 698/10
 10,5 cm/4¹/₄"



KUEHNE
AB 699/10
 10,5 cm/4¹/₄"

PINZETTEN FORCEPS PINZAS PINCES PINZE

Irispinzetten
Iris Forceps
Pinzas para iris
Pincès à iris
Pinze per iride



AB 700/07

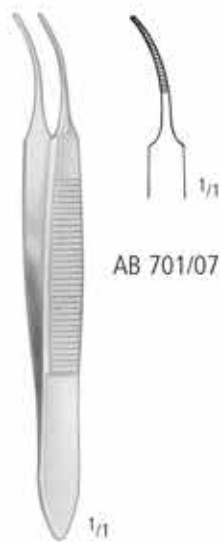

AB 701/07



AB 702/07

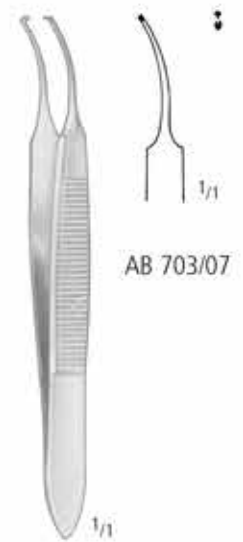

AB 703/07

GRAEFE
7,0 cm/2³/₄"
0,5 mm **AB 700/05**
0,7 mm **AB 700/07**
1,0 mm **AB 700/10**

GRAEFE
7,0 cm/2³/₄"
AB 701/05
AB 701/07
AB 701/10

GRAEFE 1:2
7,0 cm/2³/₄"
AB 702/05
AB 702/07
AB 702/10

GRAEFE 1:2
7,0 cm/2³/₄"
AB 703/05
AB 703/07
AB 703/10



GRAEFE

7,0 cm/2³/₄"
10,0 cm/4"



AB 710/07
AB 710/10

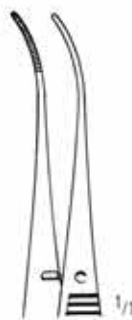

AB 711/07
AB 711/10

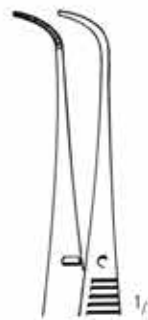

AB 713/07
AB 713/10

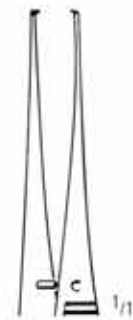

AB 714/07
AB 714/10



AB 715/07
AB 715/10



AB 717/07
AB 717/10

AA
AB
AC
AD
AE
AF
AG
AH
AI
AJ
AK
AL
AM
AN
AO
AP
AQ
AR
AS
AT
AU
AV
AW
AX
AY
AZ
BA
BB
BC
BD
BE
BF
BG
BH
BI
BJ
BK
BL
BM
BN
BO
BP
BQ
BR
BS
BT
BU
BV
BW
BX
BY
BZ
CA
CB
CC
CD
CE
CF
CG
CH
CI
CJ
CK
CL
CM
CN
CO
CP
CQ
CR
CS
CT
CU
CV
CW
CX
CY
CZ
DA
DB
DC
DD
DE
DF
DG
DH
DI
DJ
DK
DL
DM
DN
DO
DP
DQ
DR
DS
DT
DU
DV
DW
DX
DY
DZ
EA
EB
EC
ED
EE
EF
EG
EH
EI
EJ
EK
EL
EM
EN
EO
EP
EQ
ER
ES
ET
EU
EV
EW
EX
EY
EZ
FA
FB
FC
FD
FE
FF
FG
FH
FI
FJ
FK
FL
FM
FN
FO
FP
FQ
FR
FS
FT
FU
FV
FW
FX
FY
FZ
GA
GB
GC
GD
GE
GF
GG
GH
GI
GJ
GK
GL
GM
GN
GO
GP
GQ
GR
GS
GT
GU
GV
GW
GX
GY
GZ
HA
HB
HC
HD
HE
HF
HG
HH
HI
HJ
HK
HL
HM
HN
HO
HP
HQ
HR
HS
HT
HU
HV
HW
HX
HY
HZ
IA
IB
IC
ID
IE
IF
IG
IH
II
IJ
IK
IL
IM
IN
IO
IP
IQ
IR
IS
IT
IU
IV
IW
IX
IY
IZ
JA
JB
JC
JD
JE
JF
JG
JH
JI
JJ
JK
JL
JM
JN
JO
JP
JQ
JR
JS
JT
JU
JV
JW
JX
JY
JZ
KA
KB
KC
KD
KE
KF
KG
KH
KI
KJ
KK
KL
KM
KN
KO
KP
KQ
KR
KS
KT
KU
KV
KW
KX
KY
KZ
LA
LB
LC
LD
LE
LF
LG
LH
LI
LJ
LK
LL
LM
LN
LO
LP
LQ
LR
LS
LT
LU
LV
LW
LX
LY
LZ
MA
MB
MC
MD
ME
MF
MG
MH
MI
MJ
MK
ML
MM
MN
MO
MP
MQ
MR
MS
MT
MU
MV
MW
MX
MY
MZ
NA
NB
NC
ND
NE
NF
NG
NH
NI
NJ
NK
NL
NM
NN
NO
NP
NQ
NR
NS
NT
NU
NV
NW
NX
NY
NZ
OA
OB
OC
OD
OE
OF
OG
OH
OI
OJ
OK
OL
OM
ON
OO
OP
OQ
OR
OS
OT
OU
OV
OW
OX
OY
OZ
PA
PB
PC
PD
PE
PF
PG
PH
PI
PJ
PK
PL
PM
PN
PO
PP
PQ
PR
PS
PT
PU
PV
PW
PX
PY
PZ
QA
QB
QC
QD
QE
QF
QG
QH
QI
QJ
QK
QL
QM
QN
QO
QP
QQ
QR
QS
QT
QU
QV
QW
QX
QY
QZ
RA
RB
RC
RD
RE
RF
RG
RH
RI
RJ
RK
RL
RM
RN
RO
RP
RQ
RR
RS
RT
RU
RV
RW
RX
RY
RZ
SA
SB
SC
SD
SE
SF
SG
SH
SI
SJ
SK
SL
SM
SN
SO
SP
SQ
SR
SS
ST
SU
SV
SW
SX
SY
SZ
TA
TB
TC
TD
TE
TF
TG
TH
TI
TJ
TK
TL
TM
TN
TO
TP
TQ
TR
TS
TT
TU
TV
TW
TX
TY
TZ
UA
UB
UC
UD
UE
UF
UG
UH
UI
UJ
UK
UL
UM
UN
UO
UP
UQ
UR
US
UT
UU
UV
UW
UX
UY
UZ
VA
VB
VC
VD
VE
VF
VG
VH
VI
VJ
VK
VL
VM
VN
VO
VP
VQ
VR
VS
VT
VU
VV
VW
VX
VY
VZ
WA
WB
WC
WD
WE
WF
WG
WH
WI
WJ
WK
WL
WM
WN
WO
WP
WQ
WR
WS
WT
WU
WV
WW
WX
WY
WZ
XA
XB
XC
XD
XE
XF
XG
XH
XI
XJ
XK
XL
XM
XN
XO
XP
XQ
XR
XS
XT
XU
XV
XW
XX
XY
XZ
YA
YB
YC
YD
YE
YF
YG
YH
YI
YJ
YK
YL
YM
YN
YO
YP
YQ
YR
YS
YT
YU
YV
YW
YX
YY
YZ
ZA
ZB
ZC
ZD
ZE
ZF
ZG
ZH
ZI
ZJ
ZK
ZL
ZM
ZN
ZO
ZP
ZQ
ZR
ZS
ZT
ZU
ZV
ZW
ZX
ZY
ZZ

AB PINZETTEN FORCEPS PINZAS PINCES PINZE

Irispinzetten
Iris Forceps
Pinzas para iris
Pincès à iris
Pinze per iride



STEVENS 1:2
AB 718/01
11,0 cm/4¹/₃"



STEVENS 1:2
AB 718/02
11,0 cm/4¹/₃"



STEVENS
10,5 cm/4¹/₄"



AB 720/01



AB 720/02



AB 720/03



AB 721/01 1:2



AB 721/02 1:2



AB 721/03 1:2



FISCHER-ARLT 1:2
AB 723/07
7,0 cm/2³/₄"

PINZETTEN FORCEPS PINZAS PINCES PINZE

Irispinzetten
Iris Forceps
Pinzas para iris
Pincès à iris
Pinze per iride



FOERSTER
AB 726/08
8,5 cm/3¹/₃"



FOERSTER
AB 727/08
8,5 cm/3¹/₃"



FOERSTER 1:2
AB 728/08
8,5 cm/3¹/₃"



FOERSTER 1:2
AB 729/08
8,5 cm/3¹/₃"



HESS 1:2
AB 730/07
7,0 cm/2³/₄"



HESS 1:2
AB 731/09
9,0 cm/3¹/₂"



MOD. BONN 1:2
AB 734/01
7,0 cm/2³/₄"



MOD. BONN 1:2
AB 734/02
7,0 cm/2³/₄"



MOD. BONN
AB 735/01 AB 735/02
7,0 cm/2³/₄"

AA
AB
AC
AD
AE
AF
AG
AH
AI
AJ
AK
AL
AM
AN
AO
AP
AQ
AR
AS
AT
AU
AV
AW
AX
AY
AZ
BA
BB
BC
BD
BE
BF
BG
BH
BI
BJ
BK
BL
BM
BN
BO
BP
BQ
BR
BS
BT
BU
BV
BW
BX
BY
BZ
CA
CB
CC
CD
CE
CF
CG
CH
CI
CJ
CK
CL
CM
CN
CO
CP
CQ
CR
CS
CT
CU
CV
CW
CX
CY
CZ
DA
DB
DC
DD
DE
DF
DG
DH
DI
DJ
DK
DL
DM
DN
DO
DP
DQ
DR
DS
DT
DU
DV
DW
DX
DY
DZ
EA
EB
EC
ED
EE
EF
EG
EH
EI
EJ
EK
EL
EM
EN
EO
EP
EQ
ER
ES
ET
EU
EV
EW
EX
EY
EZ
FA
FB
FC
FD
FE
FF
FG
FH
FI
FJ
FK
FL
FM
FN
FO
FP
FQ
FR
FS
FT
FU
FV
FW
FX
FY
FZ
GA
GB
GC
GD
GE
GF
GG
GH
GI
GJ
GK
GL
GM
GN
GO
GP
GQ
GR
GS
GT
GU
GV
GW
GX
GY
GZ
HA
HB
HC
HD
HE
HF
HG
HH
HI
HJ
HK
HL
HM
HN
HO
HP
HQ
HR
HS
HT
HU
HV
HW
HX
HY
HZ
IA
IB
IC
ID
IE
IF
IG
IH
II
IJ
IK
IL
IM
IN
IO
IP
IQ
IR
IS
IT
IU
IV
IW
IX
IY
IZ
JA
JB
JC
JD
JE
JF
JG
JH
JI
JJ
JK
JL
JM
JN
JO
JP
JQ
JR
JS
JT
JU
JV
JW
JX
JY
JZ
KA
KB
KC
KD
KE
KF
KG
KH
KI
KJ
KK
KL
KM
KN
KO
KP
KQ
KR
KS
KT
KU
KV
KW
KX
KY
KZ
LA
LB
LC
LD
LE
LF
LG
LH
LI
LJ
LK
LL
LM
LN
LO
LP
LQ
LR
LS
LT
LU
LV
LW
LX
LY
LZ
MA
MB
MC
MD
ME
MF
MG
MH
MI
MJ
MK
ML
MM
MN
MO
MP
MQ
MR
MS
MT
MU
MV
MW
MX
MY
MZ
NA
NB
NC
ND
NE
NF
NG
NH
NI
NJ
NK
NL
NM
NN
NO
NP
NQ
NR
NS
NT
NU
NV
NW
NX
NY
NZ
OA
OB
OC
OD
OE
OF
OG
OH
OI
OJ
OK
OL
OM
ON
OO
OP
OQ
OR
OS
OT
OU
OV
OW
OX
OY
OZ
PA
PB
PC
PD
PE
PF
PG
PH
PI
PJ
PK
PL
PM
PN
PO
PP
PQ
PR
PS
PT
PU
PV
PW
PX
PY
PZ
QA
QB
QC
QD
QE
QF
QG
QH
QI
QJ
QK
QL
QM
QN
QO
QP
QQ
QR
QS
QT
QU
QV
QW
QX
QY
QZ
RA
RB
RC
RD
RE
RF
RG
RH
RI
RJ
RK
RL
RM
RN
RO
RP
RQ
RR
RS
RT
RU
RV
RW
RX
RY
RZ
SA
SB
SC
SD
SE
SF
SG
SH
SI
SJ
SK
SL
SM
SN
SO
SP
SQ
SR
SS
ST
SU
SV
SW
SX
SY
SZ
TA
TB
TC
TD
TE
TF
TG
TH
TI
TJ
TK
TL
TM
TN
TO
TP
TQ
TR
TS
TT
TU
TV
TW
TX
TY
TZ
UA
UB
UC
UD
UE
UF
UG
UH
UI
UJ
UK
UL
UM
UN
UO
UP
UQ
UR
US
UT
UU
UV
UW
UX
UY
UZ
VA
VB
VC
VD
VE
VF
VG
VH
VI
VJ
VK
VL
VM
VN
VO
VP
VQ
VR
VS
VT
VU
VV
VW
VX
VY
VZ
WA
WB
WC
WD
WE
WF
WG
WH
WI
WJ
WK
WL
WM
WN
WO
WP
WQ
WR
WS
WT
WU
WV
WW
WX
WY
WZ
XA
XB
XC
XD
XE
XF
XG
XH
XI
XJ
XK
XL
XM
XN
XO
XP
XQ
XR
XS
XT
XU
XV
XW
XX
XY
XZ
YA
YB
YC
YD
YE
YF
YG
YH
YI
YJ
YK
YL
YM
YN
YO
YP
YQ
YR
YS
YT
YU
YV
YW
YX
YY
YZ
ZA
ZB
ZC
ZD
ZE
ZF
ZG
ZH
ZI
ZJ
ZK
ZL
ZM
ZN
ZO
ZP
ZQ
ZR
ZS
ZT
ZU
ZV
ZW
ZX
ZY
ZZ

AB PINZETTEN FORCEPS PINZAS PINCES PINZE

Irispinzetten
Iris Forceps
Pinzas para iris
Pincès à iris
Pinze per iride



BISHOP-HARMAN 1:2
AB 736/08
8,5 cm/3 1/3"



AB 738/08
8,5 cm/3 1/3"



AB 740/08
8,5 cm/3 1/3"



AB 742/08
8,5 cm/3 1/3"



KIRBY 1:2
AB 748/09
9,0 cm/3 1/2"

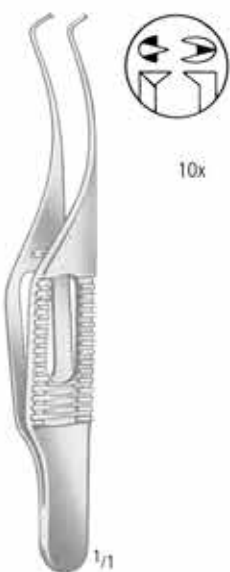

BARRAQUER-KATZIN 1:2
(Colibri)
AB 750/07
7,0 cm/2 3/4"



TROUTMAN 1:2
(Corneal)
AB 751/07
7,5 cm/3"



BARRAQUER-KATZIN 1:2
(Colibri)
AB 752/07
7,0 cm/2 3/4"



AB 756/07

Zähne seitwärts
teeth on side
dientes laterales
dents latérales
denti laterali

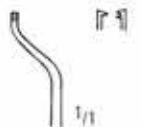

AB 757/07

Zähne unten
teeth below
dientes inferiores
dents en bas
denti in basso



GILL-HESS 1:2
7,5 cm/3"

PINZETTEN FORCEPS PINZAS PINCES PINZE

Kapselpinzetten
Capsular Forceps
Pinzas capsulares
Pincas capsulaires
Pinze capsulari



GILL 1:2
AB 762/07
7,5 cm/3"



GILL-FUCHS
AB 763/07
7,5 cm/3"



TERSON
AB 765/09
9,0 cm/3 1/2"



CASTROVIEJO
AB 767/01
10,0 cm/4"



CASTROVIEJO
AB 767/02
10,0 cm/4"



ungeeicht
not calibrated
non calibrada
non calibrée
non calibrata

AB 768/01

ARRUGA
10,0 cm/4"



geeicht
calibrated
calibrada
calibrée
calibrata

AB 768/02



ungeeicht
not calibrated
non calibrada
non calibrée
non calibrata

AB 769/01

ARRUGA
10,0 cm/4"

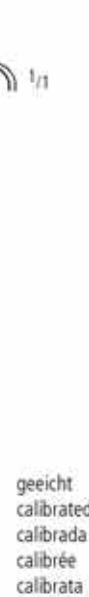

geeicht
calibrated
calibrada
calibrée
calibrata

AB 769/02



BINKHORST
AB 770/07
7,0 cm/2 3/4"

AA
AB
AC
AD
AE
AF
AG
AH
AI
AJ
AK
AL
AM
AN
AO
AP
AQ
AR
AS
AT
AU
AV
AW
AX
AY
AZ
BA
BB
BC
BD
BE
BF
BG
BH
BI
BJ
BK
BL
BM
BN
BO
BP
BQ
BR
BS
BT
BU
BV
BW
BX
BY
BZ
CA
CB
CC
CD
CE
CF
CG
CH
CI
CJ
CK
CL
CM
CN
CO
CP
CQ
CR
CS
CT
CU
CV
CW
CX
CY
CZ
DA
DB
DC
DD
DE
DF
DG
DH
DI
DJ
DK
DL
DM
DN
DO
DP
DQ
DR
DS
DT
DU
DV
DW
DX
DY
DZ
EA
EB
EC
ED
EE
EF
EG
EH
EI
EJ
EK
EL
EM
EN
EO
EP
EQ
ER
ES
ET
EU
EV
EW
EX
EY
EZ
FA
FB
FC
FD
FE
FF
FG
FH
FI
FJ
FK
FL
FM
FN
FO
FP
FQ
FR
FS
FT
FU
FV
FW
FX
FY
FZ
GA
GB
GC
GD
GE
GF
GG
GH
GI
GJ
GK
GL
GM
GN
GO
GP
GQ
GR
GS
GT
GU
GV
GW
GX
GY
GZ
HA
HB
HC
HD
HE
HF
HG
HH
HI
HJ
HK
HL
HM
HN
HO
HP
HQ
HR
HS
HT
HU
HV
HW
HX
HY
HZ
IA
IB
IC
ID
IE
IF
IG
IH
II
IJ
IK
IL
IM
IN
IO
IP
IQ
IR
IS
IT
IU
IV
IW
IX
IY
IZ
JA
JB
JC
JD
JE
JF
JG
JH
JI
JJ
JK
JL
JM
JN
JO
JP
JQ
JR
JS
JT
JU
JV
JW
JX
JY
JZ
KA
KB
KC
KD
KE
KF
KG
KH
KI
KJ
KK
KL
KM
KN
KO
KP
KQ
KR
KS
KT
KU
KV
KW
KX
KY
KZ
LA
LB
LC
LD
LE
LF
LG
LH
LI
LJ
LK
LL
LM
LN
LO
LP
LQ
LR
LS
LT
LU
LV
LW
LX
LY
LZ
MA
MB
MC
MD
ME
MF
MG
MH
MI
MJ
MK
ML
MM
MN
MO
MP
MQ
MR
MS
MT
MU
MV
MW
MX
MY
MZ
NA
NB
NC
ND
NE
NF
NG
NH
NI
NJ
NK
NL
NM
NN
NO
NP
NQ
NR
NS
NT
NU
NV
NW
NX
NY
NZ
OA
OB
OC
OD
OE
OF
OG
OH
OI
OJ
OK
OL
OM
ON
OO
OP
OQ
OR
OS
OT
OU
OV
OW
OX
OY
OZ
PA
PB
PC
PD
PE
PF
PG
PH
PI
PJ
PK
PL
PM
PN
PO
PP
PQ
PR
PS
PT
PU
PV
PW
PX
PY
PZ
QA
QB
QC
QD
QE
QF
QG
QH
QI
QJ
QK
QL
QM
QN
QO
QP
QQ
QR
QS
QT
QU
QV
QW
QX
QY
QZ
RA
RB
RC
RD
RE
RF
RG
RH
RI
RJ
RK
RL
RM
RN
RO
RP
RQ
RR
RS
RT
RU
RV
RW
RX
RY
RZ
SA
SB
SC
SD
SE
SF
SG
SH
SI
SJ
SK
SL
SM
SN
SO
SP
SQ
SR
SS
ST
SU
SV
SW
SX
SY
SZ
TA
TB
TC
TD
TE
TF
TG
TH
TI
TJ
TK
TL
TM
TN
TO
TP
TQ
TR
TS
TT
TU
TV
TW
TX
TY
TZ
UA
UB
UC
UD
UE
UF
UG
UH
UI
UJ
UK
UL
UM
UN
UO
UP
UQ
UR
US
UT
UU
UV
UW
UX
UY
UZ
VA
VB
VC
VD
VE
VF
VG
VH
VI
VJ
VK
VL
VM
VN
VO
VP
VQ
VR
VS
VT
VU
VV
VW
VX
VY
VZ
WA
WB
WC
WD
WE
WF
WG
WH
WI
WJ
WK
WL
WM
WN
WO
WP
WQ
WR
WS
WT
WU
WV
WW
WX
WY
WZ
XA
XB
XC
XD
XE
XF
XG
XH
XI
XJ
XK
XL
XM
XN
XO
XP
XQ
XR
XS
XT
XU
XV
XW
XX
XY
XZ
YA
YB
YC
YD
YE
YF
YG
YH
YI
YJ
YK
YL
YM
YN
YO
YP
YQ
YR
YS
YT
YU
YV
YW
YX
YY
YZ
ZA
ZB
ZC
ZD
ZE
ZF
ZG
ZH
ZI
ZJ
ZK
ZL
ZM
ZN
ZO
ZP
ZQ
ZR
ZS
ZT
ZU
ZV
ZW
ZX
ZY
ZZ

AB PINZETTEN FORCEPS PINZAS PINCES PINZE

Fixierpinzetten
Fixation Forceps
Pinzas de fijacion
Pincas à fixer
Pinze fissatrici

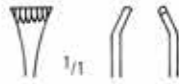

AB 785/01
ohne Schloss
without spring catch
sin cierre de resorte
sans arrêt à ressort
senza arresto a molla

AB 785/02
mit Schloss
with spring catch
con cierre de resorte
avec arrêt à ressort
con arresto a molla

GRAEFE
11,0 cm/4¹/₃"



AB 786/01
5 mm



AB 786/02
10 mm

GREEN
10,0 cm/4"



AB 790/09



AB 791/09

CASTROVIEJO 1:1
9,0 cm/3¹/₂"



ELSCHNIG 1:2
AB 792/11
11,0 cm/4¹/₃"

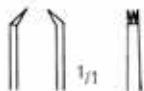

ELSCHNIG 2:3
AB 793/11
11,0 cm/4¹/₃"

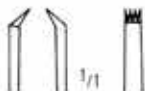

ELSCHNIG 3:4
AB 794/11
11,0 cm/4¹/₃"



1:2
AB 796/02



2:3
AB 796/03

LESTER
9,0 cm/3¹/₂"



MOORFIELD
AB 798/10
10,0 cm/4"

PINZETTEN FORCEPS PINZAS PINCES PINZE

Nahtpinzetten
Suture Forceps
Pinzas para sutura
Pincas pour sutures
Pinze per sutura

Vorderkammer-Pinzetten
Anterior Chamber Forceps
Pinzas para la cámara anterior
Pincas pour la chambre antérieure
Pinze per la camera anteriore

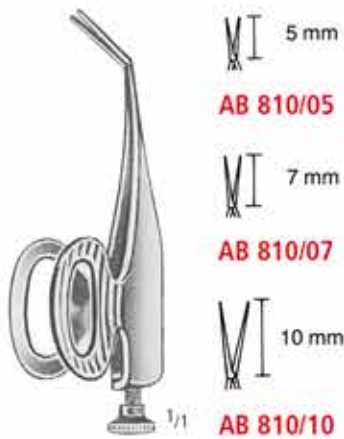

BARRAQUER
5,5 cm/2 1/4"



ST. MARTIN 1:2
AB 812/07
7,0 cm/2 3/4"



CASTROVIEJO 1:2
10,0 cm/4"



CASTROVIEJO 1:2
10,0 cm/4"



McPHERSON
10,0 cm/4"



KELMAN-McPHERSON 1:2
AB 820/10
10,0 cm/4"



BONACCOLTO
AB 824/01
10,0 cm/4"



BONACCOLTO
AB 824/02
10,0 cm/4"

AA
AB
AC
AD
AE
AF
AK
AL
AM
AO
AP
AR
KA
KD
KU
KY

AB PINZETTEN FORCEPS PINZAS PINCES PINZE

Nahtpinzetten
Suture Forceps
Pinzas para sutura
Pinces pour sutures
Pinze per sutura



10 x
0,12 mm

AB 825/01



MOD. BONN
10,0 cm/4"



AB 825/02



MOD. TÜBINGEN
AB 826/10
10,0 cm/4"



PAUFIQUE 1:2
AB 828/10
10,0 cm/4"



HARMS
AB 829/01
10,0 cm/4"



HARMS
AB 829/02
10,0 cm/4"



PINZETTEN FORCEPS PINZAS PINCES PINZE

Muskelpinzetten
Muscular Forceps
Pinzas musculares
Pincas musculaires
Pinze muscolare



SATTLER
AB 830/01
10,0 cm/4"



SATTLER
AB 830/02
10,0 cm/4"



BLASCOVICS
AB 832/01
9,0 cm/3 1/2"



BLASCOVICS
AB 832/02
9,0 cm/3 1/2"



JAMESON
AB 833/01
10,0 cm/4"



JAMESON
AB 833/02
10,0 cm/4"



PRINCE
AB 834/01
10,0 cm/4"



PRINCE
AB 834/02
10,0 cm/4"

AA

AB

AC

AD

AE

AF

AK

AL

AM

AO

AP

AR

KA

KD

KU

KV

AB PINZETTEN FORCEPS PINZAS PINCES PINZE

Muskel-, Entropium- und Chalazionpinzetten
 Muscular, Entropium and Chalazion Forceps
 Pinzas musculares, Pinzas de entropion y de chalazión
 Pincés musculaires, Pincés à entropion et à chalazion
 Pinze muscolare, Pinze per palpebre (entropio) e per calazio



BERENS
AB 835/09
 8,5 cm/3 1/3"



ERHARDT
AB 836/09
 9,0 cm/3 1/2"



SNELLEN
AB 837/01
 10,0 cm/4"



SNELLEN
AB 837/02
 10,0 cm/4"



AYER
AB 838/01
 9,0 cm/3 1/2"



AYER
AB 838/02
 9,0 cm/3 1/2"



DESMARRES
 9,0 cm/3 1/2"



AB 840/01



AB 840/02

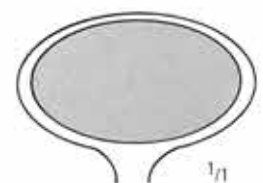

AB 840/03

PINZETTEN FORCEPS PINZAS PINCES PINZE

Chalazionpinzetten
Chalazion Forceps
Pinzas de chalazión
Pincés à chalazion
Pinze per calazio



LAMPERT
AB 841/01
9,0 cm/3 1/2"



LAMPERT
AB 841/02
9,0 cm/3 1/2"



BERKE
AB 844/20
11,0 cm/4 1/3"
20 mm



BERKE
AB 844/27
11,0 cm/4 1/3"
27 mm

AA

AB

AC

AD

AE

AF

AK

AL

AM

AO

AP

AR

KA

KD

KU

KY

AB PINZETTEN FORCEPS PINZAS PINCES PINZE

Linsenhalte- und Kapsulorhexispinzetten
 Lens Holding and Capsulorhexis Forceps
 Pinzas para tener cristalino y capsulorhexis
 Pincès à tenir de cristallins et capsulorhexis
 Pinze per tenere il cristallino, Pinze capsulorhexis



FAULKNER
AB 848/11
 11,0 cm/4 $\frac{1}{3}$ "



AB 852/01
 10,0 cm/4"



McDONALD
AB 852/02
 10,0 cm/4"

PINZETTEN FORCEPS PINZAS PINCES PINZE

Atraumatische Pinzetten
 Non-traumatic Vascular Tissue Forceps
 Pinzas Atrauma
 Pincas Atrauma
 Pinze Atrauma



AB 860/16 = 16,0 cm/6¹/₄"
AB 860/20 = 20,0 cm/8"
AB 860/24 = 24,0 cm/9¹/₂"

DE BAKAY

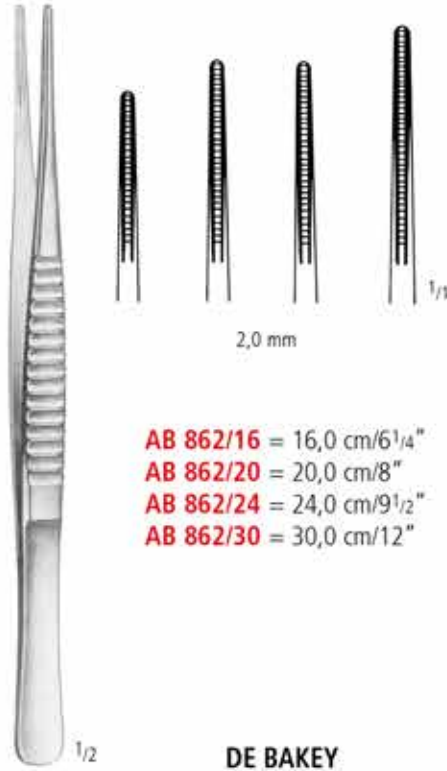

AB 862/16 = 16,0 cm/6¹/₄"
AB 862/20 = 20,0 cm/8"
AB 862/24 = 24,0 cm/9¹/₂"
AB 862/30 = 30,0 cm/12"

DE BAKAY

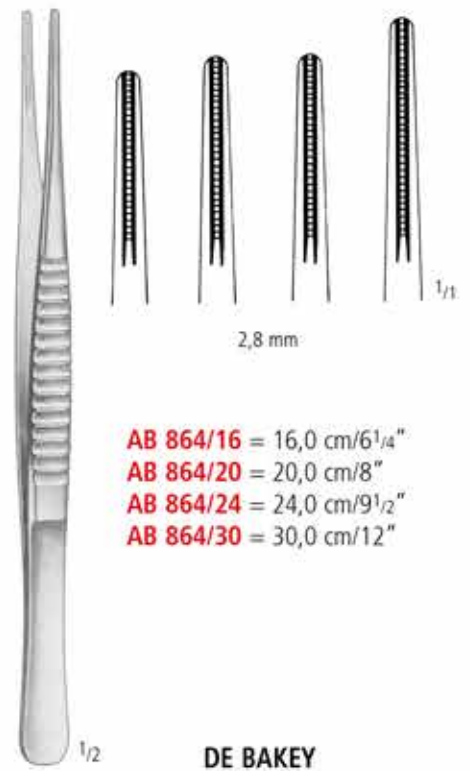

AB 864/16 = 16,0 cm/6¹/₄"
AB 864/20 = 20,0 cm/8"
AB 864/24 = 24,0 cm/9¹/₂"
AB 864/30 = 30,0 cm/12"

DE BAKAY

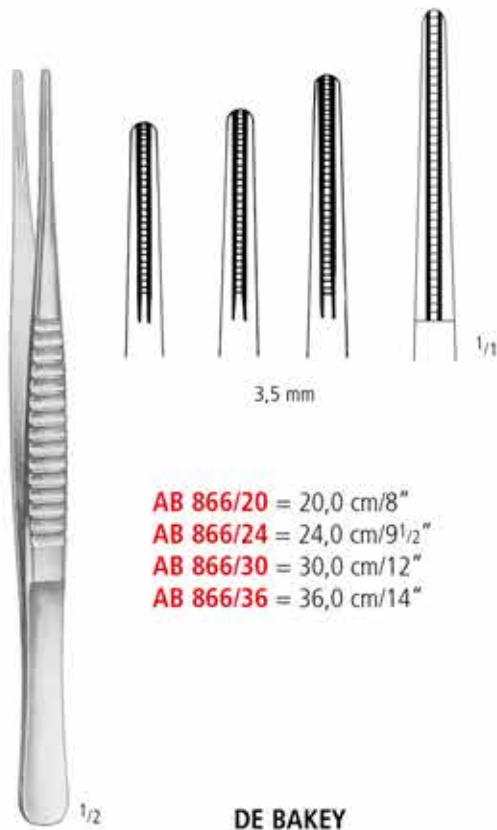

AB 866/20 = 20,0 cm/8"
AB 866/24 = 24,0 cm/9¹/₂"
AB 866/30 = 30,0 cm/12"
AB 866/36 = 36,0 cm/14"

DE BAKAY

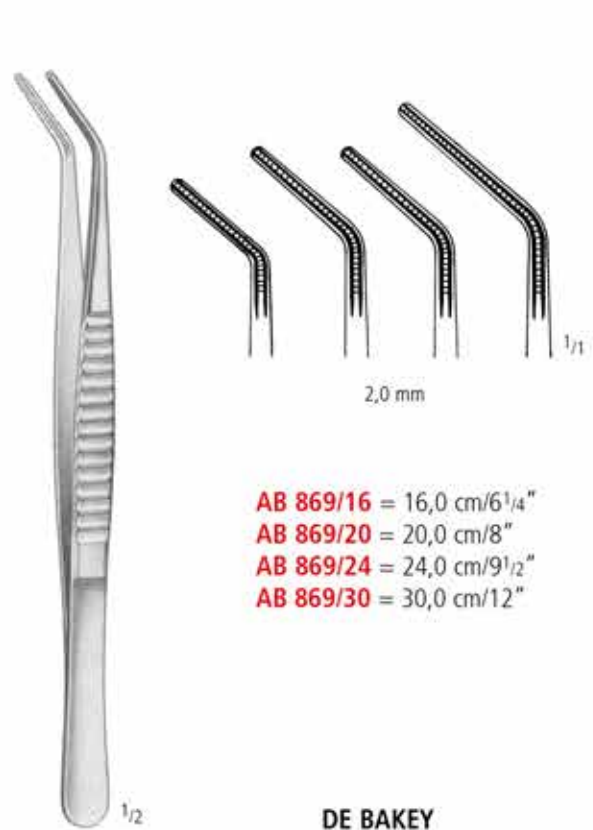

AB 869/16 = 16,0 cm/6¹/₄"
AB 869/20 = 20,0 cm/8"
AB 869/24 = 24,0 cm/9¹/₂"
AB 869/30 = 30,0 cm/12"

DE BAKAY

AA
 AB
 AC
 AD
 AE
 AF
 AG
 AH
 AI
 AJ
 AK
 AL
 AM
 AN
 AO
 AP
 AQ
 AR
 AS
 AT
 AU
 AV
 AW
 AX
 AY
 AZ

AB PINZETTEN FORCEPS PINZAS PINCES PINZE

Pinzetten mit Hartmetalleinsätzen
 Dissecting Forceps with Tungsten Carbide Inserts
 Pinzas de disección con bocas de carburo de tungsteno
 Pincès à dissection avec mors en carbure de tungstène
 Pinze per dissezione con punte di carburo di tungsteno

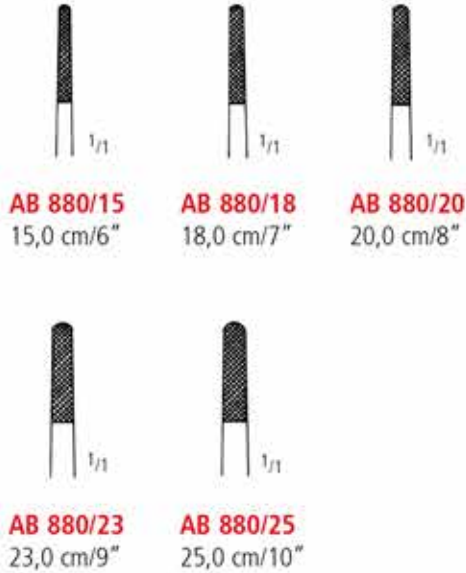

AB 880/15
15,0 cm/6"

AB 880/18
18,0 cm/7"

AB 880/20
20,0 cm/8"

AB 880/23
23,0 cm/9"

AB 880/25
25,0 cm/10"

POTTS-SMITH

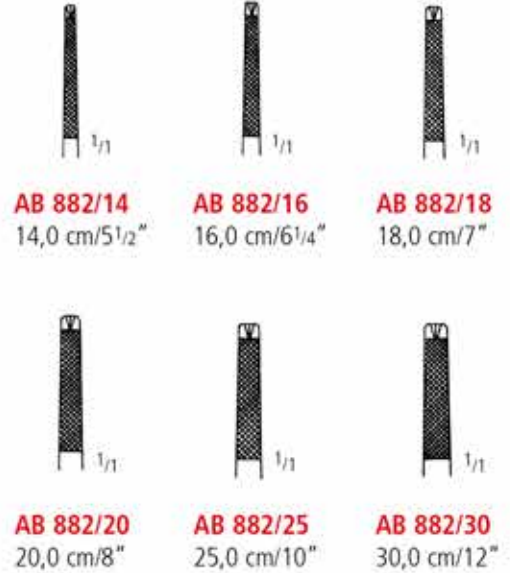

AB 882/14
14,0 cm/5 1/2"

AB 882/16
16,0 cm/6 1/4"

AB 882/18
18,0 cm/7"

AB 882/20
20,0 cm/8"

AB 882/25
25,0 cm/10"

AB 882/30
30,0 cm/12"

OEHLER 1:2

nopa[®]
TUC



AB 890/12

SEMKEN
AB 890/12 12,5 cm/5"
AB 890/15 15,5 cm/6"



GILLIES 1:2
AB 900/15
15,0 cm/6"



JEWELER
AB 902/15
15,0 cm/6"

PINZETTEN FORCEPS PINZAS PINCES PINZE

Pinzetten mit Hartmetalleinsätzen
 Dissecting Forceps with Tungsten Carbide Inserts
 Pinzas de disección con bocas de carburo de tungsteno
 Pincès à dissection avec mors en carbure de tungstène
 Pinze per dissezione con punte di carburo di tungsteno

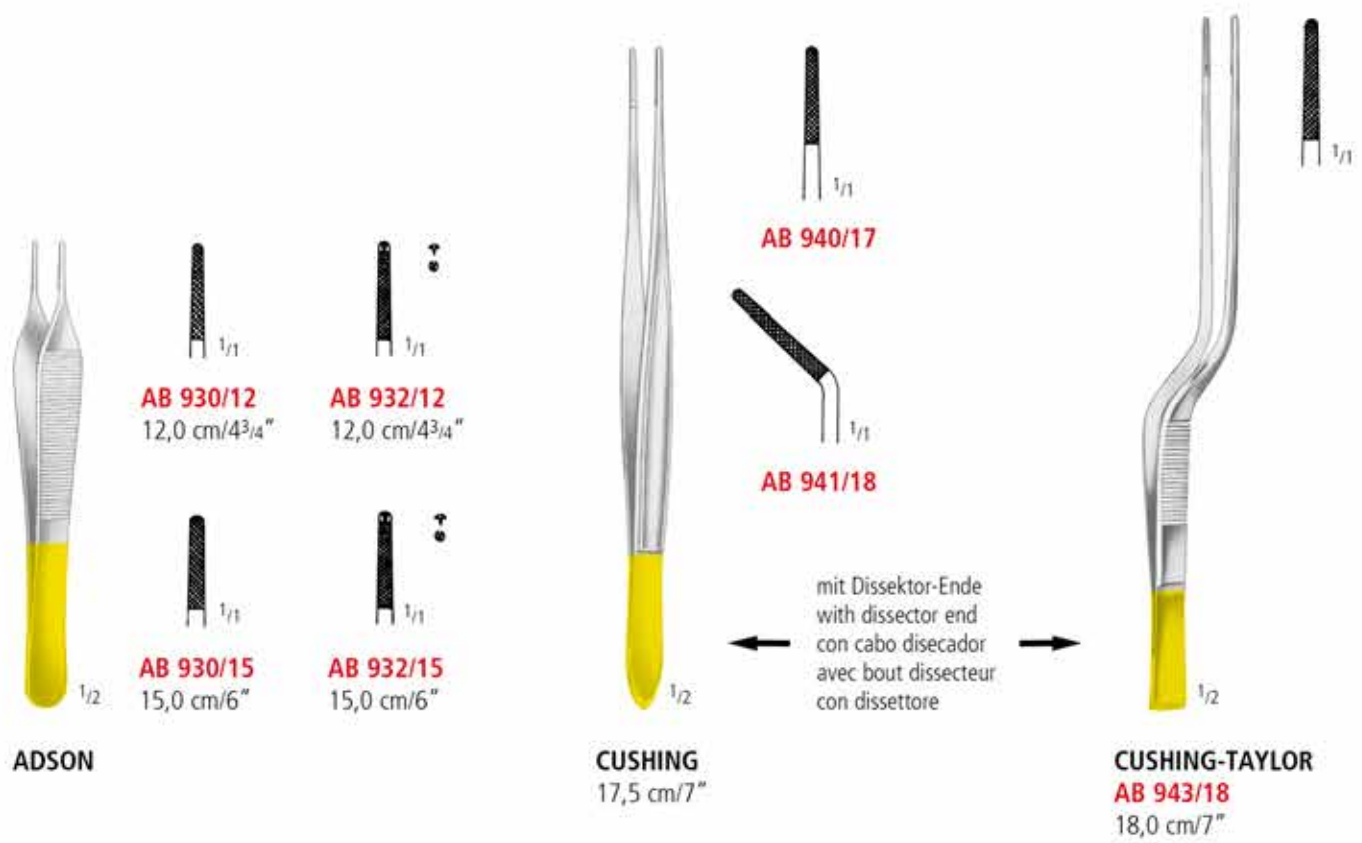

AA
 AB
 AC
 AD
 AE
 AF
 AG
 AH
 AI
 AJ
 AK
 AL
 AM
 AN
 AO
 AP
 AQ
 AR
 AS
 AT
 AU
 AV
 AW
 AX
 AY
 AZ

AB PINZETTEN FORCEPS PINZAS PINCES PINZE

Pinzetten mit Hartmetalleinsätzen
 Dissecting Forceps with Tungsten Carbide Inserts
 Pinzas de disección con bocas de carburo de tungsteno
 Pincés à dissection avec mors en carbure de tungstène
 Pinze per dissezione con punte di carburo di tungsteno



DE BAKEY
 16,0 cm/6¹/₄"
 20,0 cm/8"
 24,0 cm/9¹/₂"

1,5 mm	2,0 mm
AB 944/16	AB 946/16
AB 944/20	AB 946/20
AB 944/24	AB 946/24



BONNEY 1:2
AB 948/18
 18,0 cm/7"



WANGENSTEEN

AB 950/15
 15,0 cm/6"

AB 950/23
 23,0 cm/9"

PINZETTEN FORCEPS PINZAS PINCES PINZE

Zahnpinzetten
 Cotton and Dressing Pliers
 Pinzas para algodón y curaciones
 Précelles (Brucelles) pour coton
 Pinze per cotone



Fig. 1

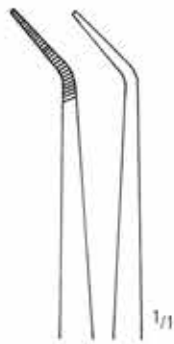

Fig. 3



Fig. 5

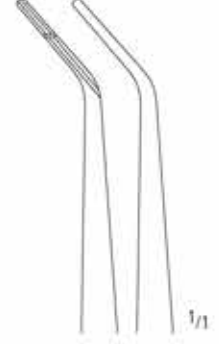

Fig. 8



LONDON COLLEGE
 15,0 cm/6"
AB 970/01
AB 970/03
AB 970/05

Fig. 1
 Fig. 3
 Fig. 5
 Fig. 8



LONDON COLLEGE
 15,0 cm/6"
AB 971/01
AB 971/03
AB 971/05



LONDON COLLEGE
 15,0 cm/6"
AB 973/01
AB 973/03
AB 973/05
AB 973/08

AA

AB

AC

AD

AE

AF

AK

AL

AM

AO

AP

AR

KA

KD

KU

KY

AB PINZETTEN FORCEPS PINZAS PINCES PINZE

Zahnpinzetten
 Cotton and Dressing Pliers
 Pinzas para algodón y curaciones
 Précelles (Brucelles) pour coton
 Pinze per cotone



Fig. 1



Fig. 3

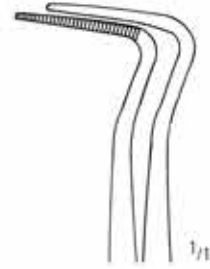

Fig. 5



MERIAM
 16,0 cm/6¹/₄"
AB 976/01
AB 976/03
AB 976/05



MERIAM
 16,0 cm/6¹/₄"
AB 977/01
AB 977/03
AB 977/05



FLAGG
 16,0 cm/6¹/₄"
AB 978/01
AB 978/03



FLAGG
 16,0 cm/6¹/₄"
AB 979/01
AB 979/03

Fig. 1
 Fig. 3
 Fig. 5

PINZETTEN FORCEPS PINZAS PINCES PINZE

Zahnpinzetten, Nahtpinzetten
 Cotton and Dressing Pliers, Suture Tweezers
 Pinzas para algodón y curaciones, Pinzas de sutura
 Précelles (Brucelles) pour coton, Pincés de suture
 Pinze per cotone, Pinze per sutura



2/3

LANDGRAF
 15,0 cm/6"

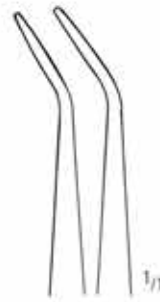

1/1

Fig. 4
AB 981/04



2/3

PERRY
 12,5 cm/5"

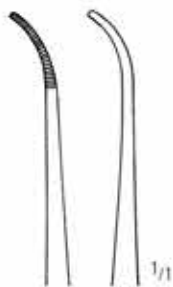

1/1

Fig. 1
AB 983/01



1/1

Fig. 2
AB 983/02



2/3

15,0 cm/6"

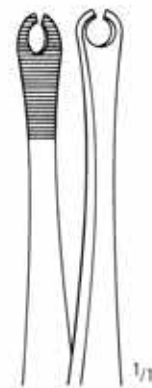

1/1

AB 988/01

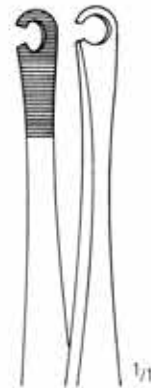

1/1

AB 988/02

AA

AB

AC

AD

AE

AF

AK

AL

AM

AO

AP

AR

KA

KD

KU

KY

AB PINZETTEN FORCEPS PINZAS PINCES PINZE

Markierungspinzetten, Artikulationspapier-Pinzetten
 Pocket Markers, Articulating Paper Forceps
 Pinzas para bolsas, Pinzas para papel de articular
 Pincés pour cul-de-sac, Pincés pour papier à articulation
 Pinze per marcazione, Pinze per carta di articolazione

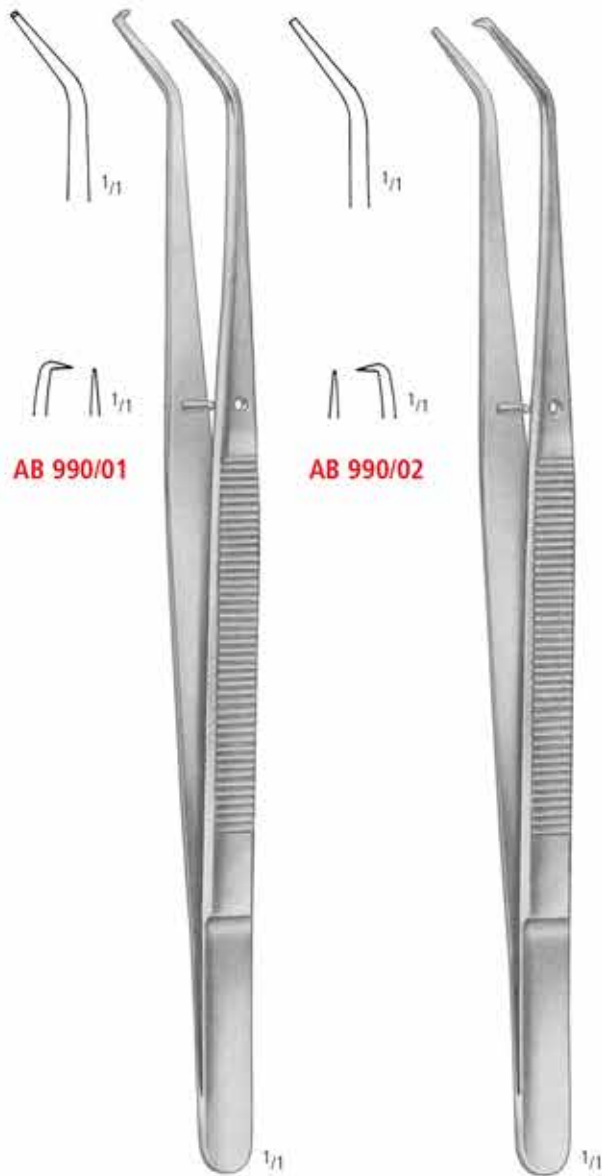

AB 990/01

AB 990/02

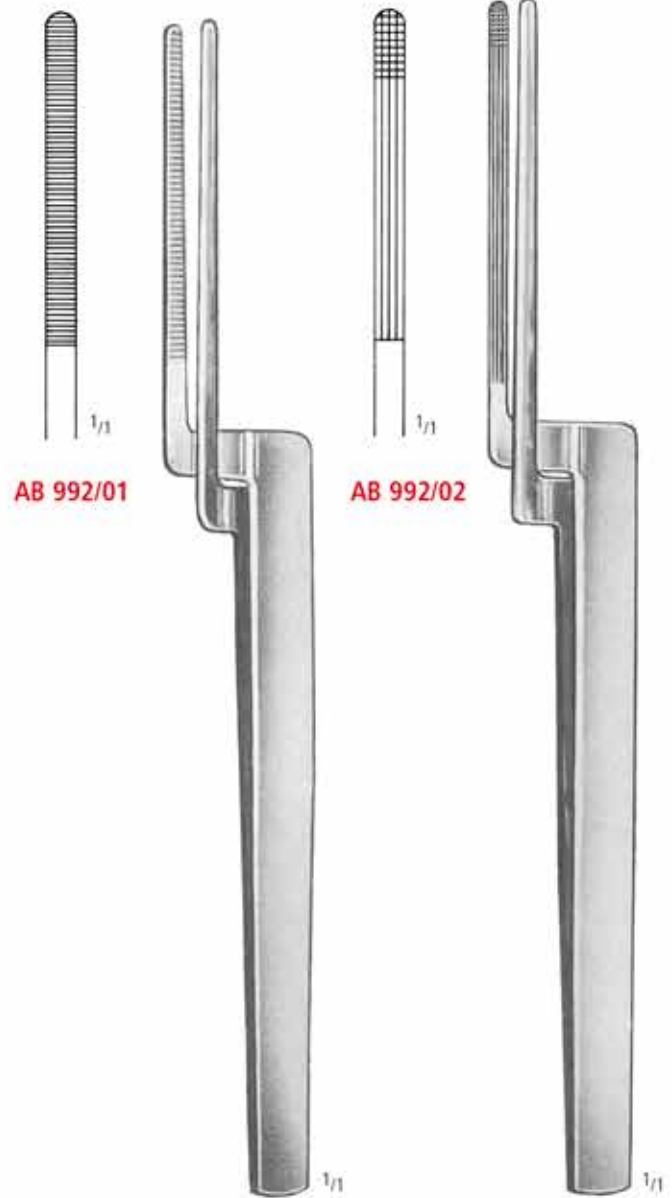

AB 992/01

AB 992/02

CRANE-KAPLAN

AB 990/01
15,0 cm/6"

AB 990/02
15,0 cm/6"

MILLER

15,0 cm/6"

SCHEREN
SCISSORS
TIJERAS
CISEAUX
FORBICI

AC

nopa[®] instruments



nopa® SC
SUPER CUT



SUPER CUT

Besonderheit:

nopa Super Cut Scheren haben eine rasierklingenscharfe Schneide, kombiniert mit einer mikrogezahnten Schneide.

>> Diese Scheren sind durch schwarze Ringe gekennzeichnet.

Features:

nopa Super Cut scissors have a razor-like edge combined with one micro serrated blade.

>> Black rings for easy identification.

Verfügbare Modelle / Available Patterns

Im Katalog durch * markiert. / Marked in catalog with *.

AC 020/13 SC STANDARD OPER.SCS. STR. SH/BL 13.0 CM SC
AC 020/14 SC STANDARD OPER.SCS. STR. SH/BL 14.0 CM SC
AC 021/13 SC STANDARD OPER.SCS. CVD. SH/BL 13.0 CM SC
AC 021/14 SC STANDARD OPER.SCS. CVD. SH/BL 14.0 CM SC
AC 070/14 SC MAYO OPER.SCS. STR. BL/BL 14.5 CM SC
AC 070/17 SC MAYO OPER.SCS. STR. BL/BL 17.0 CM SC
AC 070/23 SC MAYO OPER.SCS. STR. BL/BL 23.0 CM SC
AC 071/14 SC MAYO OPER.SCS. CVD. BL/BL 14.5 CM SC
AC 071/17 SC MAYO OPER.SCS. CVD. BL/BL 17.0 CM SC
AC 071/23 SC MAYO OPER.SCS. CVD. BL/BL 23.0 CM SC
AC 073/17 SC MAYO-STILLE OPER.SCS. CVD. BL/BL 17.0 CM SC
AC 100/14 SC METZENBAUM SCS. STR. BL/BL 14.0 CM SC
AC 101/14 SC METZENBAUM SCS. CVD. BL/BL 14.0 CM SC
AC 110/18 SC METZENBAUM-NELSON SCS. STR. BL/BL 18.0 CM SC
AC 110/20 SC METZENBAUM-NELSON SCS. STR. BL/BL 20.0 CM SC
AC 110/23 SC METZENBAUM-NELSON SCS. STR. BL/BL 23.0 CM SC
AC 111/18 SC METZENBAUM-NELSON SCS. CVD. BL/BL 18.0 CM SC
AC 111/20 SC METZENBAUM-NELSON SCS. CVD. BL/BL 20.0 CM SC
AC 111/23 SC METZENBAUM-NELSON SCS. CVD. BL/BL 23.0 CM SC
AC 141/14 SC METZENBAUM-DELICATE SCS. BL/BL CVD. 14.5 CM SC
AC 151/18 SC METZENBAUM-DELICATE SCS. BL/BL CVD. 18.0 CM SC
AC 214/15 SC REYNOLDS DISS.SCS. STR. SH/SH 15.0 CM SC
AC 214/18 SC REYNOLDS DISS.SCS. CVD. SH/SH 18.0 CM SC
AC 450/11 SC IRIS SCS. STR. SH/SH 11.5 CM SC
AC 451/11 SC IRIS SCS. CVD. SH/SH 11.5 CM SC
AC 460/11 SC STRABISMUS SCS. STR. BL/BL 11.5 CM SC
AC 461/11 SC STRABISMUS SCS. CVD. BL/BL 11.5 CM SC
AC 476/11 SC STEVENS TENOTOMY SCS. STR. BL/BL 11.5 CM SC
AC 477/11 SC STEVENS TENOTOMY SCS. CVD. BL/BL 11.5 CM SC

AA

AB

AC

AD

AE

AF

AG

AH

AI

AJ

AK

AL

AM

AN

AO

AP

AQ

AC SCHEREN SCISSORS TIJERAS CISEAUX FORBICI

Chirurgische Scheren
Operating Scissors
Tijeras para cirugía
Ciseaux à chirurgie
Forbici per chirurgia

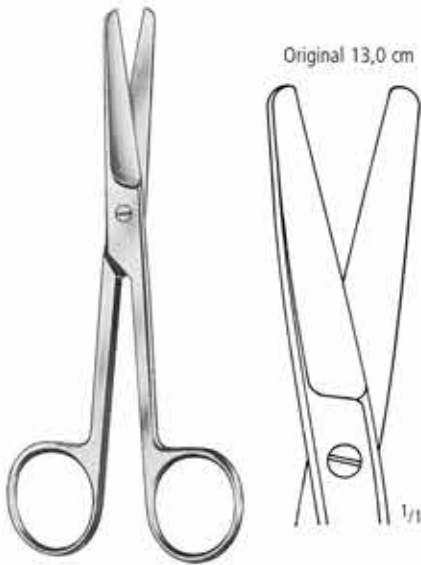

**STANDARD
STANDARD**

Fig. 1
gerade
straight
rectas
droits
rette

- | | |
|------------------|---|
| AC 010/10 | 10,5 cm/4 ¹ / ₄ " |
| AC 010/11 | 11,5 cm/4 ¹ / ₂ " |
| AC 010/13 | 13,0 cm/5" |
| AC 010/14 | 14,5 cm/5 ³ / ₄ " |
| AC 010/15 | 15,5 cm/6" |
| AC 010/16 | 16,5 cm/6 ¹ / ₂ " |
| AC 010/17 | 17,5 cm/7" |
| AC 010/18 | 18,5 cm/7 ¹ / ₃ " |
| AC 010/20 | 20,0 cm/8" |



Fig. 1
gebogen
curved
curvas
courbes
curve

- | | |
|------------------|---|
| AC 011/10 | 10,5 cm/4 ¹ / ₄ " |
| AC 011/11 | 11,5 cm/4 ¹ / ₂ " |
| AC 011/13 | 13,0 cm/5" |
| AC 011/14 | 14,5 cm/5 ³ / ₄ " |
| AC 011/15 | 15,5 cm/6" |
| AC 011/16 | 16,5 cm/6 ¹ / ₂ " |
| AC 011/17 | 17,5 cm/7" |
| AC 011/18 | 18,5 cm/7 ¹ / ₃ " |
| AC 011/20 | 20,0 cm/8" |



**STANDARD
STANDARD**

Fig. 2
gerade
straight
rectas
droits
rette

- | | |
|-------------------|---|
| AC 020/10 | 10,5 cm/4 ¹ / ₄ " |
| AC 020/11 | 11,5 cm/4 ¹ / ₂ " |
| AC 020/13* | 13,0 cm/5" |
| AC 020/14* | 14,5 cm/5 ³ / ₄ " |
| AC 020/15 | 15,5 cm/6" |
| AC 020/16 | 16,5 cm/6 ¹ / ₂ " |
| AC 020/17 | 17,5 cm/7" |
| AC 020/18 | 18,5 cm/7 ¹ / ₃ " |
| AC 020/20 | 20,0 cm/8" |



Fig. 2
gebogen
curved
curvas
courbes
curve

- | | |
|-------------------|---|
| AC 021/10 | 10,5 cm/4 ¹ / ₄ " |
| AC 021/11 | 11,5 cm/4 ¹ / ₂ " |
| AC 021/13* | 13,0 cm/5" |
| AC 021/14* | 14,5 cm/5 ³ / ₄ " |
| AC 021/15 | 15,5 cm/6" |
| AC 021/16 | 16,5 cm/6 ¹ / ₂ " |
| AC 021/17 | 17,5 cm/7" |
| AC 021/18 | 18,5 cm/7 ¹ / ₃ " |
| AC 021/20 | 20,0 cm/8" |

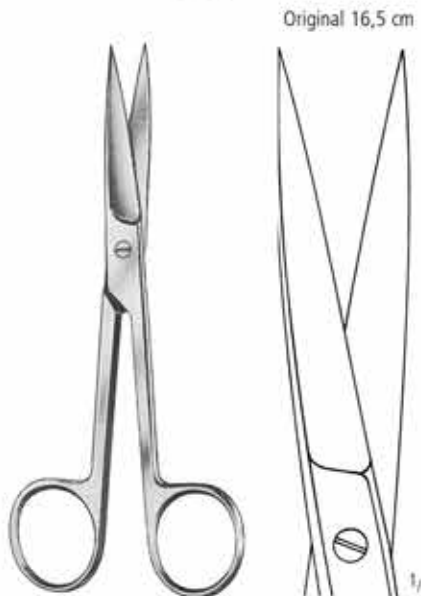

**STANDARD
STANDARD**

Fig. 3
gerade
straight
rectas
droits
rette

- | | |
|------------------|---|
| AC 030/10 | 10,5 cm/4 ¹ / ₄ " |
| AC 030/11 | 11,5 cm/4 ¹ / ₂ " |
| AC 030/13 | 13,0 cm/5" |
| AC 030/14 | 14,5 cm/5 ³ / ₄ " |
| AC 030/15 | 15,5 cm/6" |
| AC 030/16 | 16,5 cm/6 ¹ / ₂ " |
| AC 030/17 | 17,5 cm/7" |
| AC 030/18 | 18,5 cm/7 ¹ / ₃ " |
| AC 030/20 | 20,0 cm/8" |



Fig. 3
gebogen
curved
curvas
courbes
curve

- | | |
|------------------|---|
| AC 031/10 | 10,5 cm/4 ¹ / ₄ " |
| AC 031/11 | 11,5 cm/4 ¹ / ₂ " |
| AC 031/13 | 13,0 cm/5" |
| AC 031/14 | 14,5 cm/5 ³ / ₄ " |
| AC 031/15 | 15,5 cm/6" |
| AC 031/16 | 16,5 cm/6 ¹ / ₂ " |
| AC 031/17 | 17,5 cm/7" |
| AC 031/18 | 18,5 cm/7 ¹ / ₃ " |
| AC 031/20 | 20,0 cm/8" |

SCHEREN SCISSORS TIJERAS CISEAUX FORBICI

Chirurgische Scheren
Operating Scissors
Tijeras para cirugía
Ciseaux à chirurgie
Forbici per chirurgia



Original 13,0 cm



GRAZIL

Fig.1
gerade
straight
rectas
droits
rette

AC 040/13
AC 040/14

13,0 cm/5"
14,5 cm/5³/₄"

Original 13,0 cm



GRAZIL

Fig. 1
gebogen
curved
curvas
courbes
curve

AC 041/13
AC 041/14



Original 14,5 cm



GRAZIL

Fig.2
gerade
straight
rectas
droits
rette

AC 042/13
AC 042/14

13,0 cm/5"
14,5 cm/5³/₄"

Original 14,5 cm



GRAZIL

Fig. 2
gebogen
curved
curvas
courbes
curve

AC 043/13
AC 043/14



Original 14,5 cm



GRAZIL

Fig.3
gerade
straight
rectas
droits
rette

AC 046/13
AC 046/14

13,0 cm/5"
14,5 cm/5³/₄"

Original 14,5 cm



GRAZIL

Fig. 3
gebogen
curved
curvas
courbes
curve

AC 047/13
AC 047/14

AA
AB
AC
AD
AE
AF
AG
AH
AI
AJ
AK
AL
AM
AN
AO
AP
AQ
AR
AS
AT
AU
AV
AW
AX
AY
AZ
BA
BB
BC
BD
BE
BF
BG
BH
BI
BJ
BK
BL
BM
BN
BO
BP
BQ
BR
BS
BT
BU
BV
BW
BX
BY
BZ
CA
CB
CC
CD
CE
CF
CG
CH
CI
CJ
CK
CL
CM
CN
CO
CP
CQ
CR
CS
CT
CU
CV
CW
CX
CY
CZ
DA
DB
DC
DD
DE
DF
DG
DH
DI
DJ
DK
DL
DM
DN
DO
DP
DQ
DR
DS
DT
DU
DV
DW
DX
DY
DZ
EA
EB
EC
ED
EE
EF
EG
EH
EI
EJ
EK
EL
EM
EN
EO
EP
EQ
ER
ES
ET
EU
EV
EW
EX
EY
EZ
FA
FB
FC
FD
FE
FF
FG
FH
FI
FJ
FK
FL
FM
FN
FO
FP
FQ
FR
FS
FT
FU
FV
FW
FX
FY
FZ
GA
GB
GC
GD
GE
GF
GG
GH
GI
GJ
GK
GL
GM
GN
GO
GP
GQ
GR
GS
GT
GU
GV
GW
GX
GY
GZ
HA
HB
HC
HD
HE
HF
HG
HH
HI
HJ
HK
HL
HM
HN
HO
HP
HQ
HR
HS
HT
HU
HV
HW
HX
HY
HZ
IA
IB
IC
ID
IE
IF
IG
IH
II
IJ
IK
IL
IM
IN
IO
IP
IQ
IR
IS
IT
IU
IV
IW
IX
IY
IZ
JA
JB
JC
JD
JE
JF
JG
JH
JI
JJ
JK
JL
JM
JN
JO
JP
JQ
JR
JS
JT
JU
JV
JW
JX
JY
JZ
KA
KB
KC
KD
KE
KF
KG
KH
KI
KJ
KK
KL
KM
KN
KO
KP
KQ
KR
KS
KT
KU
KV
KW
KX
KY
KZ
LA
LB
LC
LD
LE
LF
LG
LH
LI
LJ
LK
LL
LM
LN
LO
LP
LQ
LR
LS
LT
LU
LV
LW
LX
LY
LZ
MA
MB
MC
MD
ME
MF
MG
MH
MI
MJ
MK
ML
MM
MN
MO
MP
MQ
MR
MS
MT
MU
MV
MW
MX
MY
MZ
NA
NB
NC
ND
NE
NF
NG
NH
NI
NJ
NK
NL
NM
NN
NO
NP
NQ
NR
NS
NT
NU
NV
NW
NX
NY
NZ
OA
OB
OC
OD
OE
OF
OG
OH
OI
OJ
OK
OL
OM
ON
OO
OP
OQ
OR
OS
OT
OU
OV
OW
OX
OY
OZ
PA
PB
PC
PD
PE
PF
PG
PH
PI
PJ
PK
PL
PM
PN
PO
PP
PQ
PR
PS
PT
PU
PV
PW
PX
PY
PZ
QA
QB
QC
QD
QE
QF
QG
QH
QI
QJ
QK
QL
QM
QN
QO
QP
QQ
QR
QS
QT
QU
QV
QW
QX
QY
QZ
RA
RB
RC
RD
RE
RF
RG
RH
RI
RJ
RK
RL
RM
RN
RO
RP
RQ
RR
RS
RT
RU
RV
RW
RX
RY
RZ
SA
SB
SC
SD
SE
SF
SG
SH
SI
SJ
SK
SL
SM
SN
SO
SP
SQ
SR
SS
ST
SU
SV
SW
SX
SY
SZ
TA
TB
TC
TD
TE
TF
TG
TH
TI
TJ
TK
TL
TM
TN
TO
TP
TQ
TR
TS
TT
TU
TV
TW
TX
TY
TZ
UA
UB
UC
UD
UE
UF
UG
UH
UI
UJ
UK
UL
UM
UN
UO
UP
UQ
UR
US
UT
UU
UV
UW
UX
UY
UZ
VA
VB
VC
VD
VE
VF
VG
VH
VI
VJ
VK
VL
VM
VN
VO
VP
VQ
VR
VS
VT
VU
VV
VW
VX
VY
VZ
WA
WB
WC
WD
WE
WF
WG
WH
WI
WJ
WK
WL
WM
WN
WO
WP
WQ
WR
WS
WT
WU
WV
WW
WX
WY
WZ
XA
XB
XC
XD
XE
XF
XG
XH
XI
XJ
XK
XL
XM
XN
XO
XP
XQ
XR
XS
XT
XU
XV
XW
XX
XY
XZ
YA
YB
YC
YD
YE
YF
YG
YH
YI
YJ
YK
YL
YM
YN
YO
YP
YQ
YR
YS
YT
YU
YV
YW
YX
YZ
ZA
ZB
ZC
ZD
ZE
ZF
ZG
ZH
ZI
ZJ
ZK
ZL
ZM
ZN
ZO
ZP
ZQ
ZR
ZS
ZT
ZU
ZV
ZW
ZX
ZY
ZZ

AC SCHEREN SCISSORS TIJERAS CISEAUX FORBICI

Chirurgische Scheren
Operating Scissors
Tijeras para cirugía
Ciseaux à chirurgie
Forbici per chirurgia



Inzisionsscheren
Incision Scissors
Tijeras para incision
Ciseaux à incision
Forbici per incisioni

AC 052/13 = 13,0 cm/5"
AC 052/14 = 14,5 cm/5³/₄"



AC 054/15
15,5 cm/6"



RICHTER
AC 056/14
14,5 cm/5³/₄"

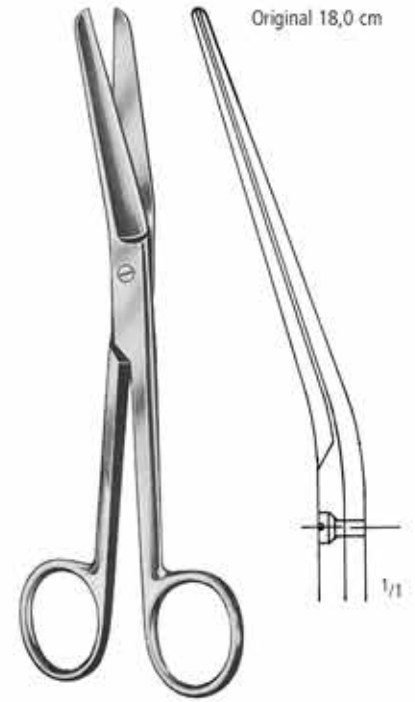

FERGUSSON
AC 058/16 = 16,5 cm/6¹/₂"
AC 058/18 = 18,0 cm/7"



AC 060/14 **DEAVER**
14,0 cm/5¹/₂"



AC 061/14



AC 062/15

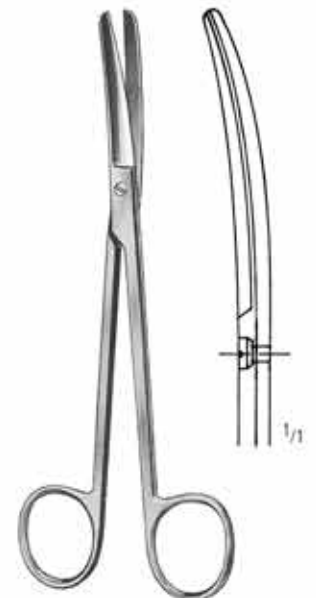

MIXTER
15,5 cm/6" **AC 063/15**

SCHEREN SCISSORS TIJERAS CISEAUX FORBICI

Chirurgische und Gynäkologische Scheren
 Operating and Gynecological Scissors
 Tijeras para cirugía y ginecología
 Ciseaux à chirurgie et à gynécologie
 Forbici per chirurgia e ginecologia

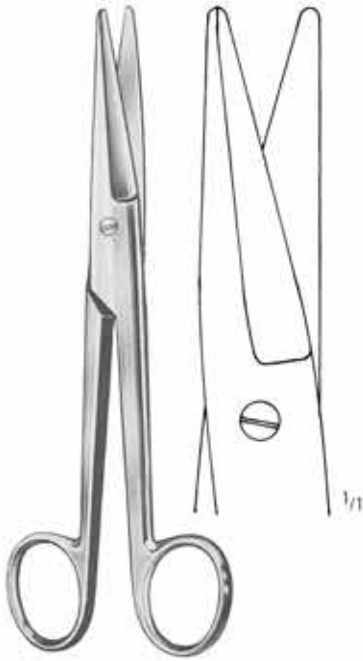

AC 064/17

MAYO-NOBLE
 17,0 cm/6³/₄"

AC 065/17

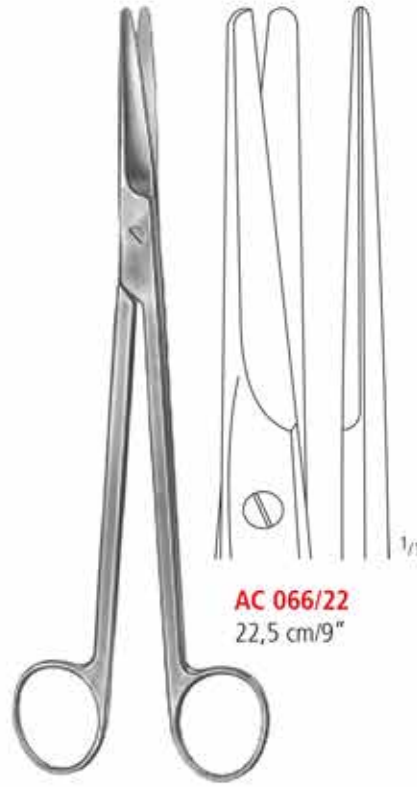
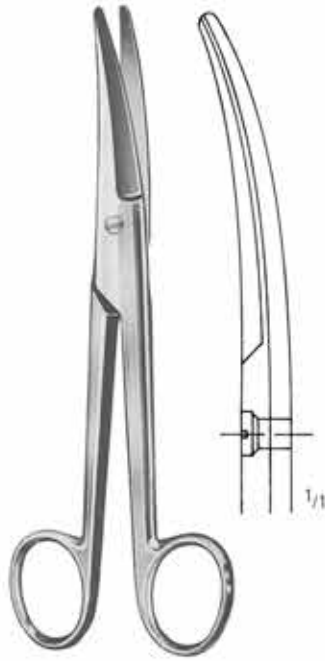

AC 066/22
 22,5 cm/9"

AC 067/22
 22,5 cm/9"

MAYO-HARRINGTON

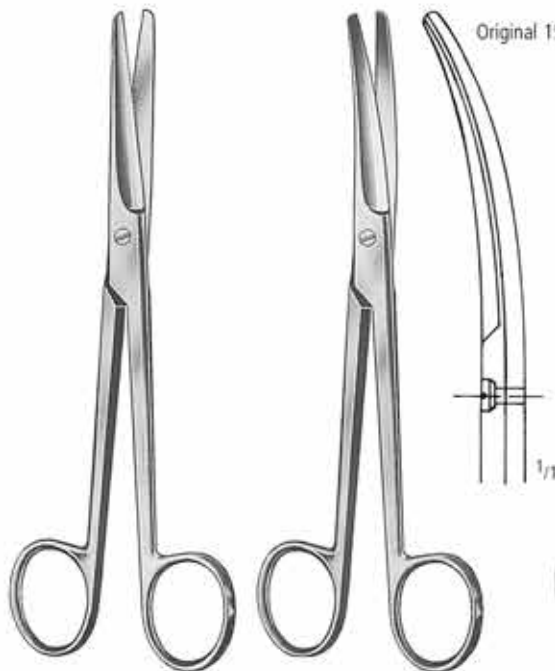

MAYO

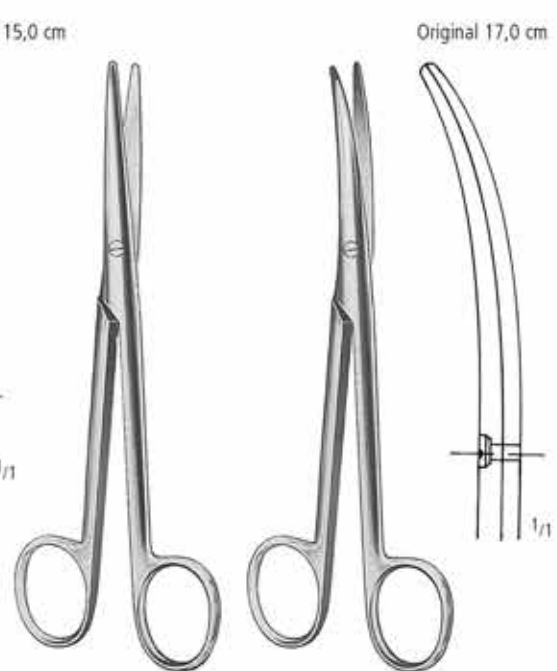

MAYO-STILLE

14,5 cm/5 ³ / ₄ "	AC 070/14*	AC 071/14*		
15,0 cm/6"			AC 072/15	AC 073/15
17,0 cm/6 ³ / ₄ "	AC 070/17*	AC 071/17*	AC 072/17	AC 073/17*
19,5 cm/7 ³ / ₄ "			AC 072/19	AC 073/19
21,0 cm/8 ¹ / ₄ "			AC 072/21	AC 073/21
23,0 cm/9"	AC 070/23*	AC 071/23*		
28,0 cm/11"	AC 070/28	AC 071/28		

* Auch erhältlich als SC * Also available as SC

AA
 AB
 AC
 AD
 AE
 AF
 AG
 AH
 AI
 AJ
 AK
 AL
 AM
 AN
 AO
 AP
 AQ
 AR
 AS
 AT
 AU
 AV
 AW
 AX
 AY
 AZ

AC SCHEREN SCISSORS TIJERAS CISEAUX FORBICI

Gynäkologische und Bauchdecken-Scheren
 Gynecological and Abdominal Scissors
 Tijeras para ginecología y Tijeras abdominales
 Ciseaux à gynécologie et Ciseaux abdominaux
 Forbici per ginecologia e Forbici addominali



DOYEN
AC 080/16
 16,0 cm/6¹/₄"

DOYEN
AC 082/16
 16,0 cm/6¹/₄"

DOYEN
AC 083/16
 16,0 cm/6¹/₄"

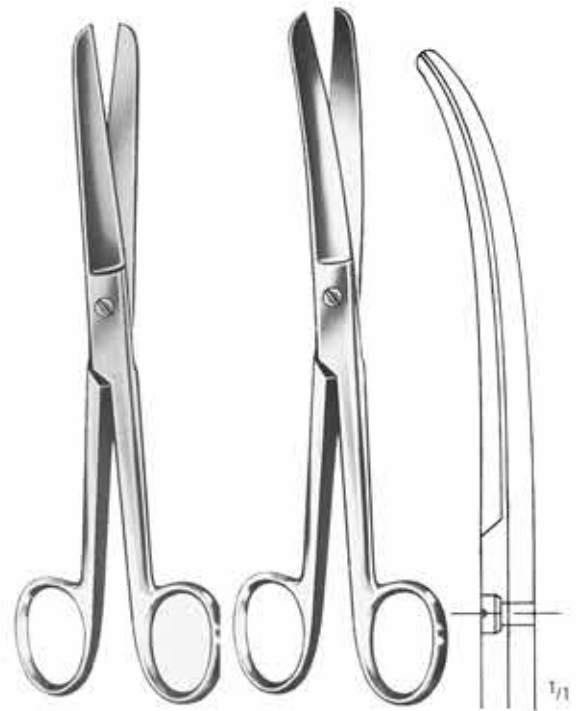

DOYEN
AC 084/18
 17,5 cm/7"

DOYEN
AC 085/18
 17,5 cm/7"

Fistelscheren
 Fistula Scissors
 Tijeras para fistulas
 Ciseaux pour fistules
 Forbici per fistole

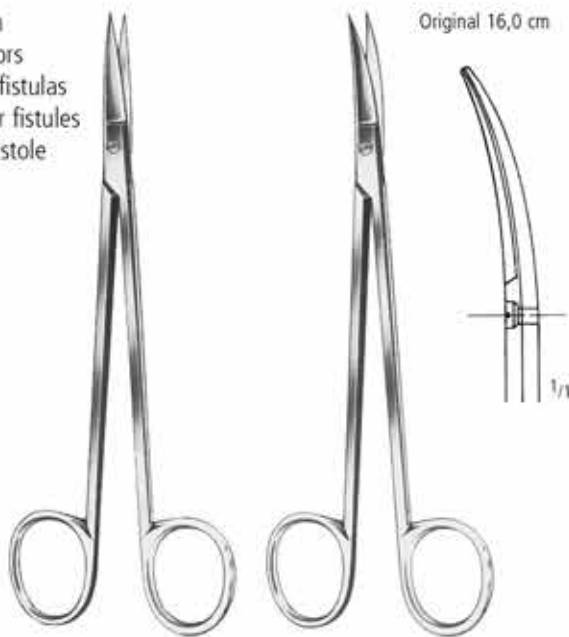

AC 086/16
AC 086/18

KELLY
 16,0 cm/6¹/₄"
 18,0 cm/7"

AC 087/16
AC 087/18

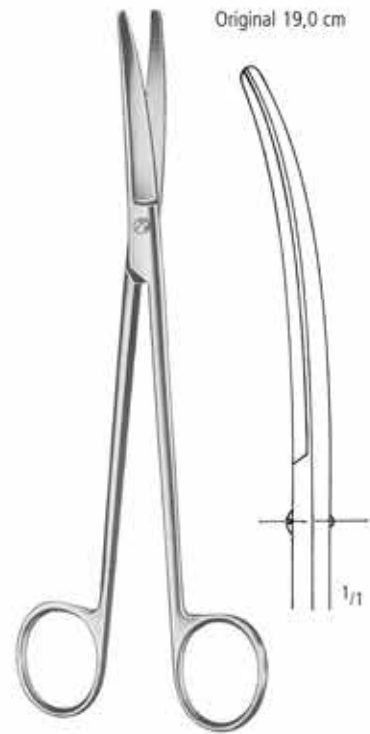

WERTHEIM
 14,5 cm/5³/₄"
 19,5 cm/7³/₄"
 22,5 cm/9"

AC 089/14
AC 089/19
AC 089/22

SCHEREN SCISSORS TIJERAS CISEAUX FORBICI

Gynäkologische Scheren
Gynecological Scissors
Tijeras para ginecología
Ciseaux à gynécologie
Forbici per ginecologia



20,0 cm/8"
23,0 cm/9" **AC 090/20**
AC 090/23



AC 092/20
AC 092/23



SIMS
AC 094/20
AC 094/23

gerade
straight
rectas
droits
rette



AC 091/20
AC 091/23

Original 20,0 cm



AC 093/20
AC 093/23

SIMS

AC 095/20
AC 095/23

gebogen
curved
curvas
courbes
curve



DUBOIS
AC 096/27
27,0 cm/10³/₄"



DUBOIS
AC 097/27
27,0 cm/10³/₄"

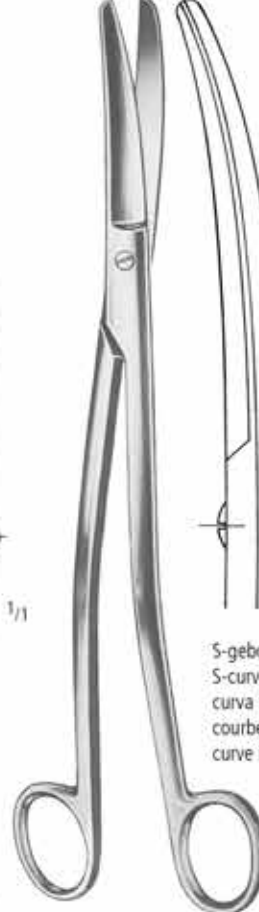

SIEBOLD
AC 098/24
24,0 cm/9¹/₂"



S-gebogen
S-curved
curva forma S
courbes en S
curve in S

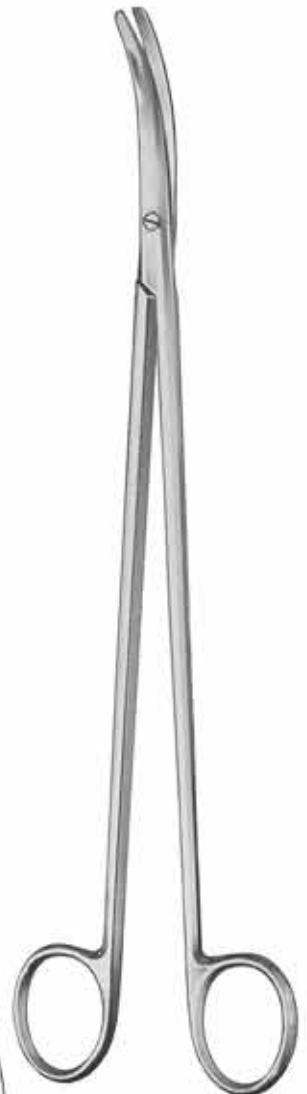
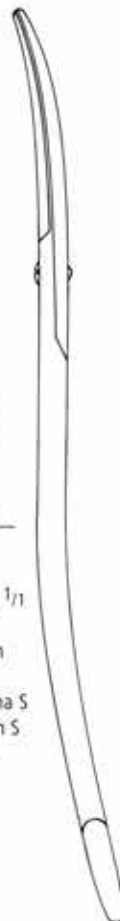

CARDINALE
AC 099/28
28,0 cm/11"

AA
AB
AC
AD
AE
AF
AK
AL
AM
AO
AP
AR
KA
KD
KU
KY

AC SCHEREN SCISSORS TIJERAS CISEAUX FORBICI

Präparierscheren
Dissecting Scissors
Tijeras para preparaciones
Ciseaux à dissection
Forbici per preparazioni

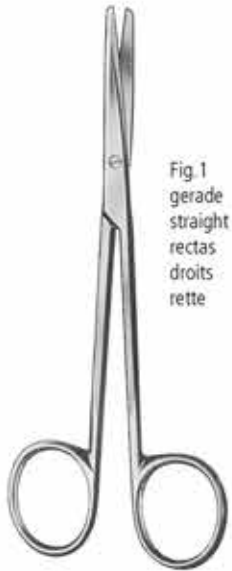

Fig. 1
gerade
straight
rectas
droits
rette

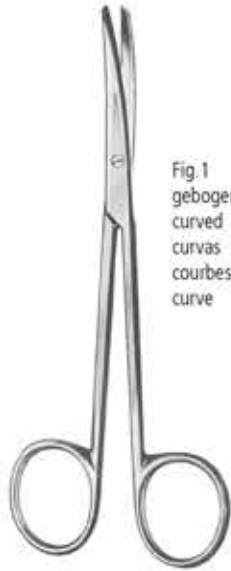

Fig. 1
gebogen
curved
curvas
courbes
curve

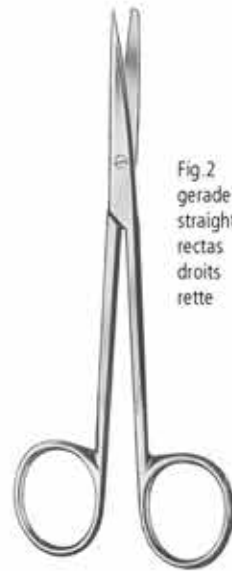

Fig. 2
gerade
straight
rectas
droits
rette

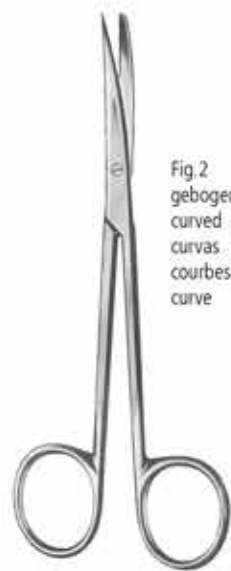

Fig. 2
gebogen
curved
curvas
courbes
curve



METZENBAUM

AC 100/14*
14,5 cm/5³/₄"

AC 101/14*
14,5 cm/5³/₄"

METZENBAUM

AC 102/14
14,5 cm/5³/₄"

AC 103/14
14,5 cm/5³/₄"



Fig. 3
gerade
straight
rectas
droits
rette

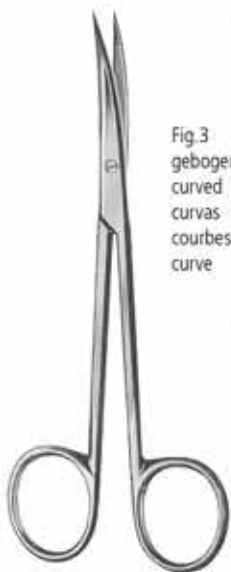
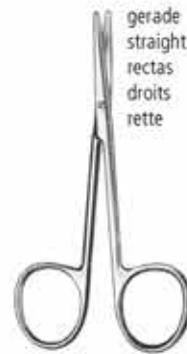
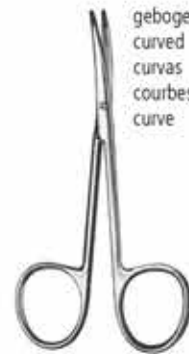

Fig. 3
gebogen
curved
curvas
courbes
curve



gerade
straight
rectas
droits
rette



gebogen
curved
curvas
courbes
curve



METZENBAUM

AC 104/14
14,5 cm/5³/₄"

AC 105/14
14,5 cm/5³/₄"

METZENBAUM-BABY

AC 108/11

AC 109/11

11,5 cm/4¹/₂"

SCHEREN SCISSORS TIJERAS CISEAUX FORBICI

Präparierscheren
Dissecting Scissors
Tijeras para preparaciones
Ciseaux à dissection
Forbici per preparazioni



METZENBAUM-NELSON



METZENBAUM-NELSON



Fig. 1



Fig. 2



Fig. 3



18,0 cm/7"	AC 110/18*	AC 111/18*	AC 120/18	AC 121/18	AC 130/18	AC 131/18
20,0 cm/8"	AC 110/20*	AC 111/20*	AC 120/20	AC 121/20	AC 130/20	AC 131/20
23,0 cm/9"	AC 110/23*	AC 111/23*	AC 120/23	AC 121/23	AC 130/23	AC 131/23
25,0 cm/10"	AC 110/25	AC 111/25	AC 120/25	AC 121/25	AC 130/25	AC 131/25
28,0 cm/11"	AC 110/28	AC 111/28	AC 120/28	AC 121/28	AC 130/28	AC 131/28
30,0 cm/12"	AC 110/30	AC 111/30	AC 120/30	AC 121/30	AC 130/30	AC 131/30

AA
AB
AC
AD
AE
AF
AG
AH
AI
AJ
AK
AL
AM
AN
AO
AP
AQ
AR
AS
AT
AU
AV
AW
AX
AY
AZ

Präparierscheren, DELICATE
 Dissecting Scissors, DELICATE
 Tijeras para preparaciones, DELICATE
 Ciseaux à dissection, DELICATE
 Forbici per preparazioni, DELICATE

METZENBAUM-DELICATE

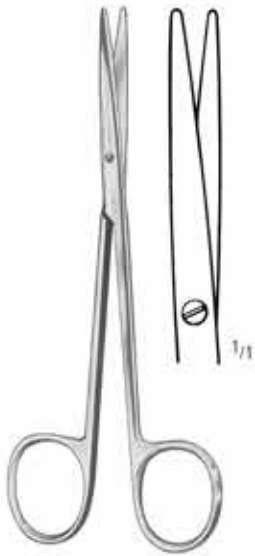

Fig. 1
AC 140/14
 14,5 cm/5³/₄"

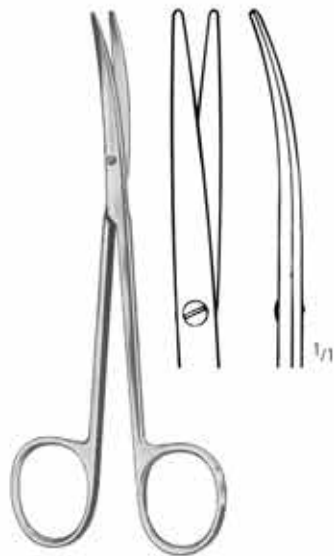

Fig. 1
AC 141/14*
 14,5 cm/5³/₄"



Fig. 3
AC 142/14
 14,5 cm/5³/₄"

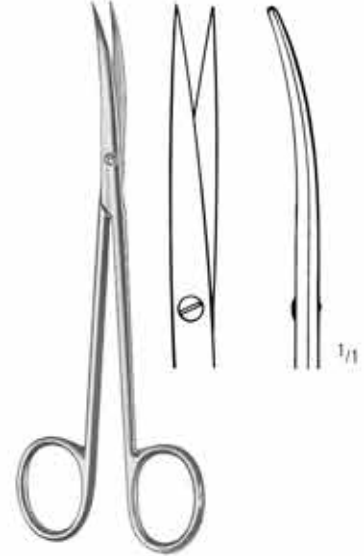

Fig. 3
AC 143/14
 14,5 cm/5³/₄"

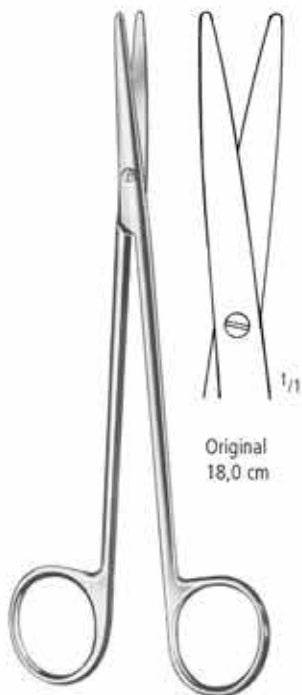

Fig. 1

Original
 18,0 cm

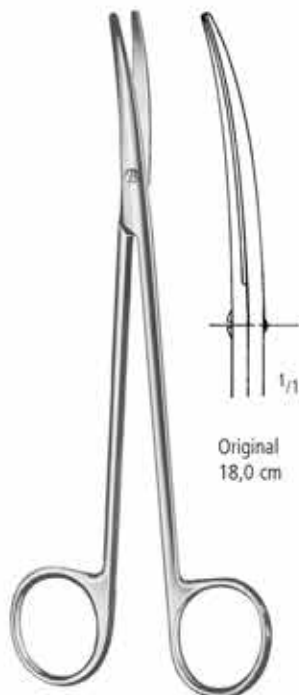

Fig. 1

Original
 18,0 cm

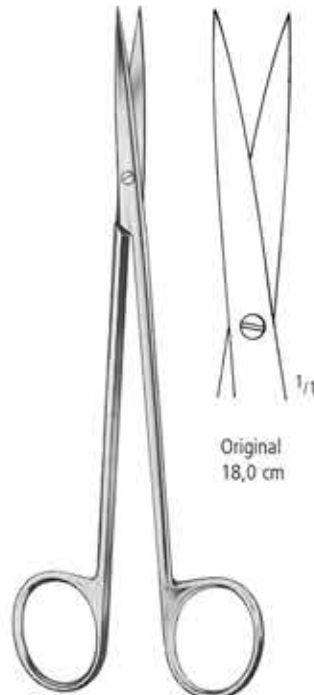

Fig. 3

Original
 18,0 cm

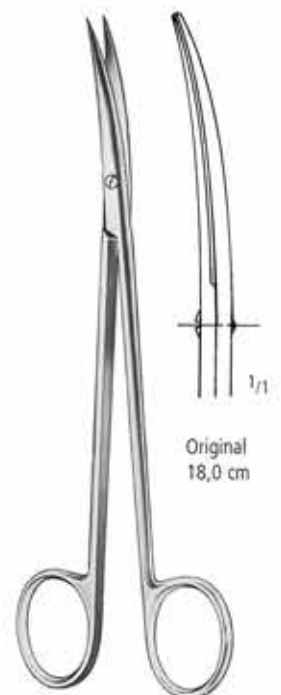

Fig. 3

Original
 18,0 cm

18,0 cm/7"	AC 150/18	AC 151/18*	AC 152/18	AC 153/18
20,0 cm/8"	AC 150/20	AC 151/20	AC 152/20	AC 153/20
23,0 cm/9"	AC 150/23	AC 151/23	AC 152/23	AC 153/23
25,0 cm/10"			AC 152/25	AC 153/25
28,0 cm/11"			AC 152/28	AC 153/28
30,0 cm/12"			AC 152/30	AC 153/30

SCHEREN SCISSORS TIJERAS CISEAUX FORBICI

Präparierscheren
Dissecting Scissors
Tijeras para preparaciones
Ciseaux à dissection
Forbici per preparazioni

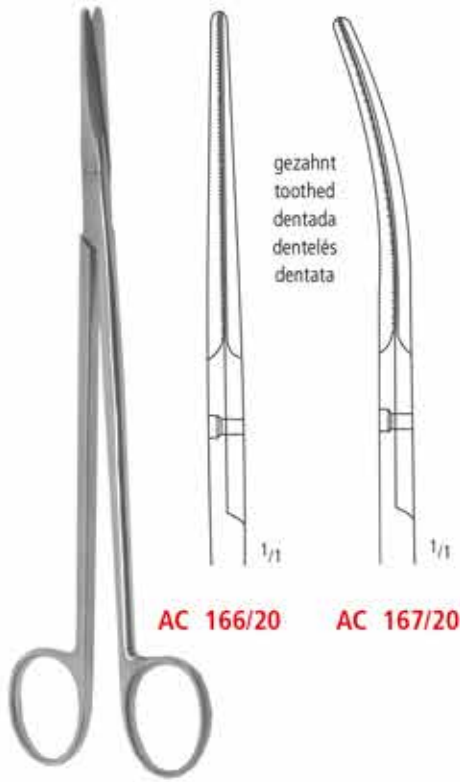

AC 166/20

AC 167/20

GORNEY
19,5 cm/7³/₄"

Nerv-Präparierschere
Nerve dissecting scissors
Tijeras para nervios
Ciseaux pour nerfs
Forbici per nervi

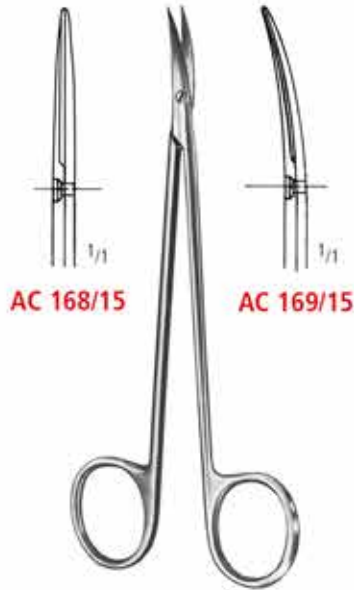

AC 168/15

AC 169/15

15,0 cm/6"



LEXER
AC 170/16
16,0 cm/6¹/₄"



LEXER
AC 171/16
16,0 cm/6¹/₄"



FOMON
AC 173/13
13,5 cm/5¹/₄"

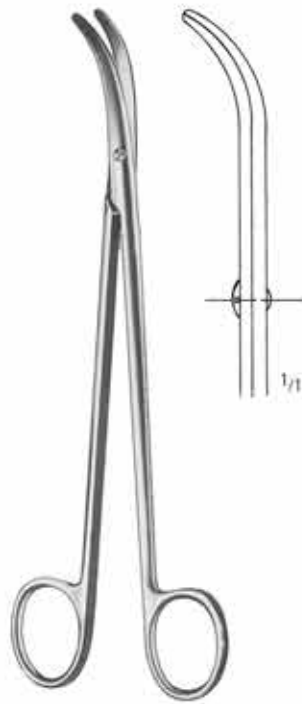

THOREK
AC 175/19
19,0 cm/7¹/₂"



LEXER-BABY
AC 176/10
10,0 cm/4"

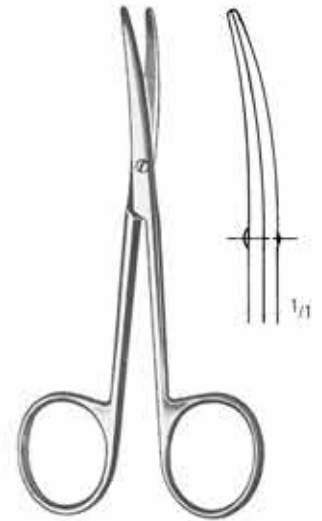

LEXER-BABY
AC 177/10
10,0 cm/4"

AA
AB
AC
AD
AE
AF
AG
AH
AI
AJ
AK
AL
AM
AN
AO
AP
AQ
AR
AS
AT
AU
AV
AW
AX
AY
AZ
BA
BB
BC
BD
BE
BF
BG
BH
BI
BJ
BK
BL
BM
BN
BO
BP
BQ
BR
BS
BT
BU
BV
BW
BX
BY
BZ
CA
CB
CC
CD
CE
CF
CG
CH
CI
CJ
CK
CL
CM
CN
CO
CP
CQ
CR
CS
CT
CU
CV
CW
CX
CY
CZ
DA
DB
DC
DD
DE
DF
DG
DH
DI
DJ
DK
DL
DM
DN
DO
DP
DQ
DR
DS
DT
DU
DV
DW
DX
DY
DZ
EA
EB
EC
ED
EE
EF
EG
EH
EI
EJ
EK
EL
EM
EN
EO
EP
EQ
ER
ES
ET
EU
EV
EW
EX
EY
EZ
FA
FB
FC
FD
FE
FF
FG
FH
FI
FJ
FK
FL
FM
FN
FO
FP
FQ
FR
FS
FT
FU
FV
FW
FX
FY
FZ
GA
GB
GC
GD
GE
GF
GG
GH
GI
GJ
GK
GL
GM
GN
GO
GP
GQ
GR
GS
GT
GU
GV
GW
GX
GY
GZ
HA
HB
HC
HD
HE
HF
HG
HH
HI
HJ
HK
HL
HM
HN
HO
HP
HQ
HR
HS
HT
HU
HV
HW
HX
HY
HZ
IA
IB
IC
ID
IE
IF
IG
IH
II
IJ
IK
IL
IM
IN
IO
IP
IQ
IR
IS
IT
IU
IV
IW
IX
IY
IZ
JA
JB
JC
JD
JE
JF
JG
JH
JI
JJ
JK
JL
JM
JN
JO
JP
JQ
JR
JS
JT
JU
JV
JW
JX
JY
JZ
KA
KB
KC
KD
KE
KF
KG
KH
KI
KJ
KK
KL
KM
KN
KO
KP
KQ
KR
KS
KT
KU
KV
KW
KX
KY
KZ
LA
LB
LC
LD
LE
LF
LG
LH
LI
LJ
LK
LL
LM
LN
LO
LP
LQ
LR
LS
LT
LU
LV
LW
LX
LY
LZ
MA
MB
MC
MD
ME
MF
MG
MH
MI
MJ
MK
ML
MM
MN
MO
MP
MQ
MR
MS
MT
MU
MV
MW
MX
MY
MZ
NA
NB
NC
ND
NE
NF
NG
NH
NI
NJ
NK
NL
NM
NN
NO
NP
NQ
NR
NS
NT
NU
NV
NW
NX
NY
NZ
OA
OB
OC
OD
OE
OF
OG
OH
OI
OJ
OK
OL
OM
ON
OO
OP
OQ
OR
OS
OT
OU
OV
OW
OX
OY
OZ
PA
PB
PC
PD
PE
PF
PG
PH
PI
PJ
PK
PL
PM
PN
PO
PP
PQ
PR
PS
PT
PU
PV
PW
PX
PY
PZ
QA
QB
QC
QD
QE
QF
QG
QH
QI
QJ
QK
QL
QM
QN
QO
QP
QQ
QR
QS
QT
QU
QV
QW
QX
QY
QZ
RA
RB
RC
RD
RE
RF
RG
RH
RI
RJ
RK
RL
RM
RN
RO
RP
RQ
RR
RS
RT
RU
RV
RW
RX
RY
RZ
SA
SB
SC
SD
SE
SF
SG
SH
SI
SJ
SK
SL
SM
SN
SO
SP
SQ
SR
SS
ST
SU
SV
SW
SX
SY
SZ
TA
TB
TC
TD
TE
TF
TG
TH
TI
TJ
TK
TL
TM
TN
TO
TP
TQ
TR
TS
TT
TU
TV
TW
TX
TY
TZ
UA
UB
UC
UD
UE
UF
UG
UH
UI
UJ
UK
UL
UM
UN
UO
UP
UQ
UR
US
UT
UU
UV
UW
UX
UY
UZ
VA
VB
VC
VD
VE
VF
VG
VH
VI
VJ
VK
VL
VM
VN
VO
VP
VQ
VR
VS
VT
VU
VV
VW
VX
VY
VZ
WA
WB
WC
WD
WE
WF
WG
WH
WI
WJ
WK
WL
WM
WN
WO
WP
WQ
WR
WS
WT
WU
WV
WW
WX
WY
WZ
XA
XB
XC
XD
XE
XF
XG
XH
XI
XJ
XK
XL
XM
XN
XO
XP
XQ
XR
XS
XT
XU
XV
XW
XX
XY
XZ
YA
YB
YC
YD
YE
YF
YG
YH
YI
YJ
YK
YL
YM
YN
YO
YP
YQ
YR
YS
YT
YU
YV
YW
YX
YY
YZ
ZA
ZB
ZC
ZD
ZE
ZF
ZG
ZH
ZI
ZJ
ZK
ZL
ZM
ZN
ZO
ZP
ZQ
ZR
ZS
ZT
ZU
ZV
ZW
ZX
ZY
ZZ

AC SCHEREN SCISSORS TIJERAS CISEAUX FORBICI

Präparierscheren
Dissecting Scissors
Tijeras para preparaciones
Ciseaux à dissection
Forbici per preparazioni

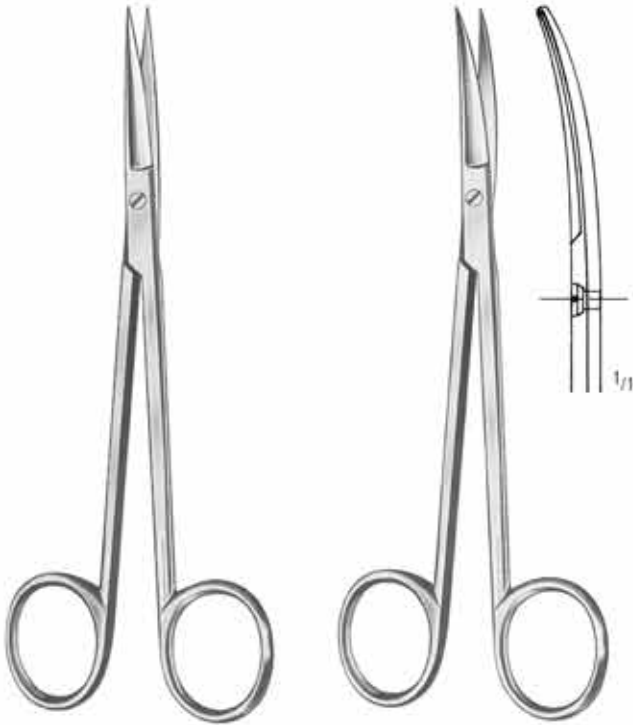

SANVENERO

AC 200/14
14,0 cm/5 1/2"

AC 201/14
14,0 cm/5 1/2"



JOSEPH

AC 204/14
14,0 cm/5 1/2"

AC 205/14
14,0 cm/5 1/2"

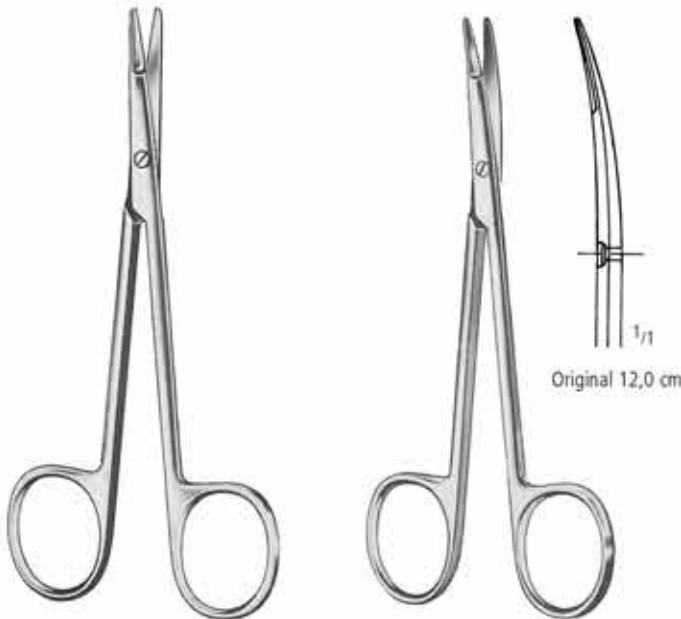

KILNER (RAGNELL)

AC 208/12	12,0 cm/4 3/4"	AC 210/12
AC 208/15	15,0 cm/6"	AC 210/15
AC 208/18	18,0 cm/7"	AC 210/18
AC 208/20	20,0 cm/8"	AC 210/20

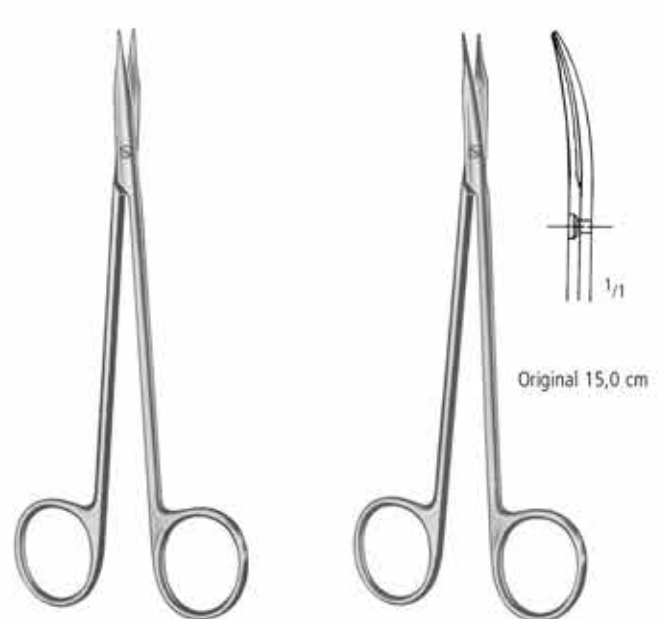

REYNOLDS

AC 214/15*	15,0 cm/6"	AC 215/15
AC 214/18*	18,0 cm/7"	AC 215/18

SCHEREN SCISSORS TIJERAS CISEAUX FORBICI

Scheren für Gefäß-Chirurgie
 Scissors for Vascular Surgery
 Tijeras para cirugía vasculares
 Ciseaux pour chirurgie vasculaire
 Forbici per chirurgia vascolare

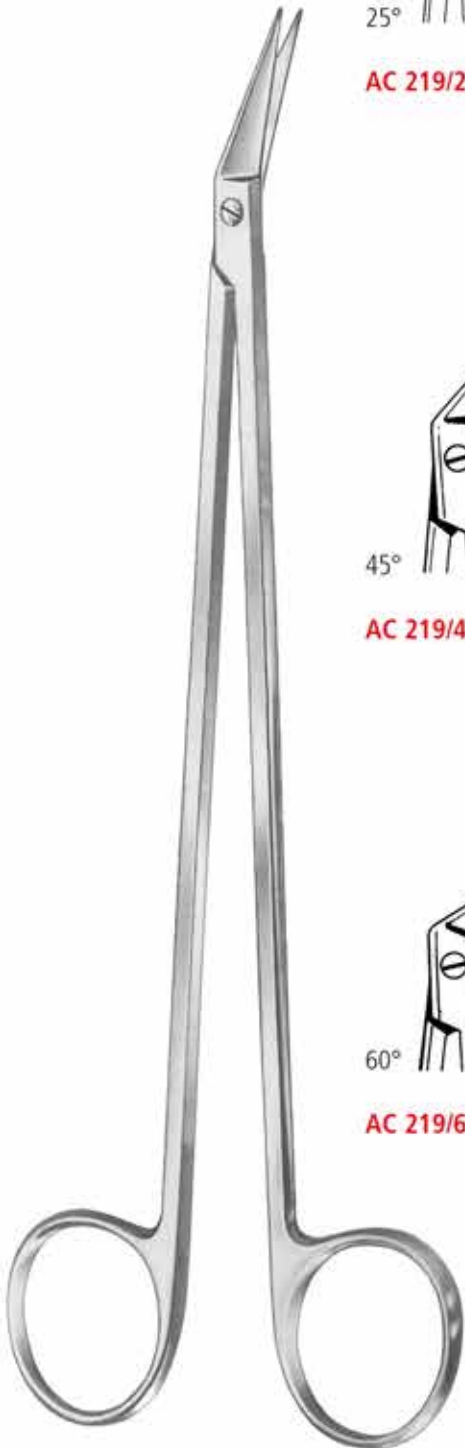

AC 219/25



AC 219/45



AC 219/60

POTTS-SMITH
 19,0 cm/7¹/₂"



AC 220/16 17,0 cm/6³/₄"
 AC 220/19 19,0 cm/7¹/₂"
 AC 220/23 23,0 cm/9"
 AC 220/28 28,0 cm/11"

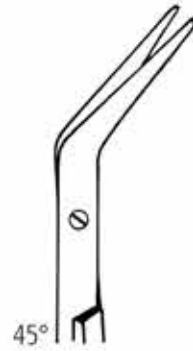

AC 221/16 17,0 cm/6³/₄"
 AC 221/19 19,0 cm/7¹/₂"
 AC 221/23 23,0 cm/9"
 AC 221/28 28,0 cm/11"

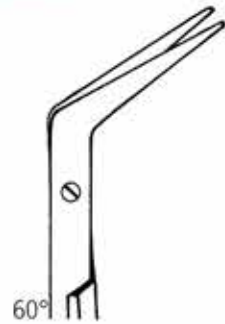

AC 222/16 17,0 cm/6³/₄"
 AC 222/19 19,0 cm/7¹/₂"
 AC 222/23 23,0 cm/9"
 AC 222/28 28,0 cm/11"

DE BAKY

AA
 AB
 AC
 AD
 AE
 AF
 AG
 AH
 AI
 AJ
 AK
 AL
 AM
 AN
 AO
 AP
 AQ
 AR
 AS
 AT
 AU
 AV
 AW
 AX
 AY
 AZ

AC SCHEREN SCISSORS TIJERAS CISEAUX FORBICI

Scheren für Gefäß-Chirurgie
 Scissors for Vascular Surgery
 Tijeras para cirugía vasculares
 Ciseaux pour chirurgie vasculaire
 Forbici per chirurgia vascolare

	 25° AC 223/01 AC 224/01	18,0 cm/7" 19,0 cm/7½"
	 45° AC 223/02 AC 224/02	18,0 cm/7" 19,0 cm/7½"
	 60° AC 223/03 AC 224/03	17,5 cm/7" 19,0 cm/7½"
	 90° AC 223/04 AC 224/04	17,0 cm/6¾" 18,0 cm/7"
	 125° AC 223/05 AC 224/05	17,0 cm/6¾" 18,0 cm/7"
18,0 cm/7"	HEGEMANN-DIETRICH	AC 225/19 19,0 cm/7½"

SCHEREN SCISSORS TIJERAS CISEAUX FORBICI

Scheren für Gefäß- und Neurochirurgie
 Scissors for Vascular and Neuro Surgery
 Tijeras para cirugía vasculares y neurocirugía
 Ciseaux pour chirurgie vasculaire et neurochirurgie
 Forbici vascolari, Forbici per neurochirurgia

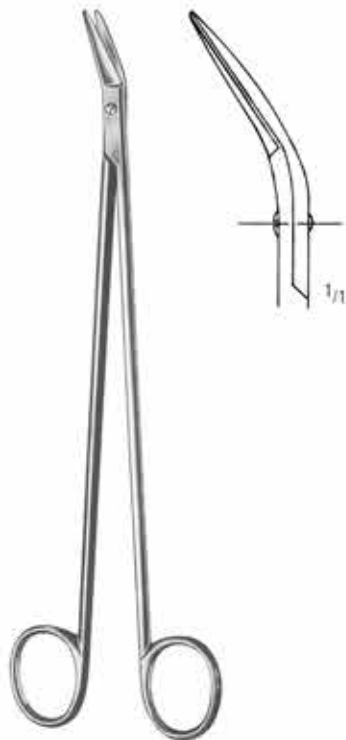

POTTS-SMITH
AC 227/19
 19,5 cm/7³/₄"

Coronar-Schere
 Coronary-Scissors
 Tijeras coronarias
 Ciseaux coronaires
 Forbici coronaria



AC 228/11
 11,5 cm/4¹/₂"



AC 230/14
 14,5 cm/5³/₄"

geknöpft
 probe pointed
 con botón
 boutonne
 bottenuto



AC 231/22
 22,0 cm/8³/₄"

STRULLY



AC 232/22
 22,0 cm/8³/₄"



DANDY
AC 233/17
 17,0 cm/6³/₄"

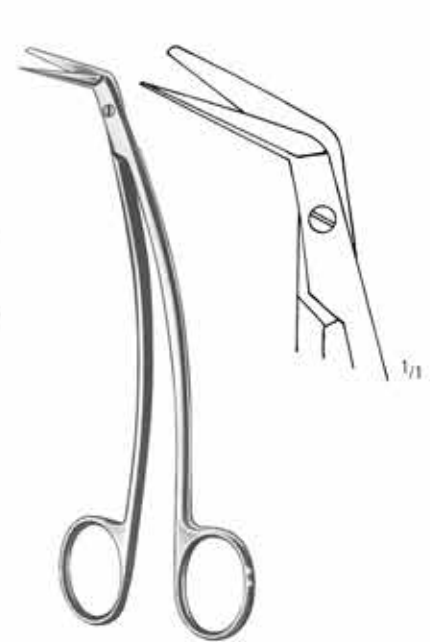

FAVALORO
AC 234/15
 15,0 cm/6"

AA
 AB
 AC
 AD
 AE
 AF
 AK
 AL
 AM
 AO
 AP
 AR
 KA
 KD
 KU
 KY

AC SCHEREN SCISSORS TIJERAS CISEAUX FORBICI

Scheren für Gefäß- und Neurochirurgie
 Scissors for Vascular and Neuro Surgery
 Tijeras para cirugía vasculares y neurocirugía
 Ciseaux pour chirurgie vasculaire et neurochirurgie
 Forbici vascolari, Forbici per neurochirurgia

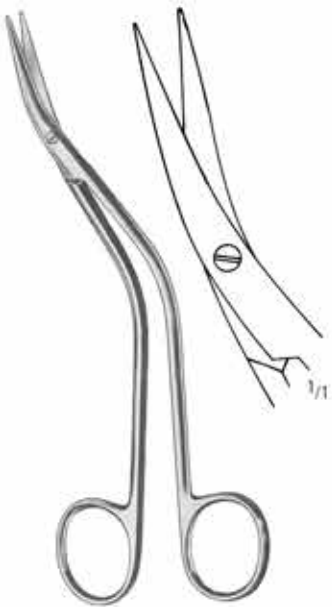

DE BAKAY

AC 235/15
 15,5 cm/6"

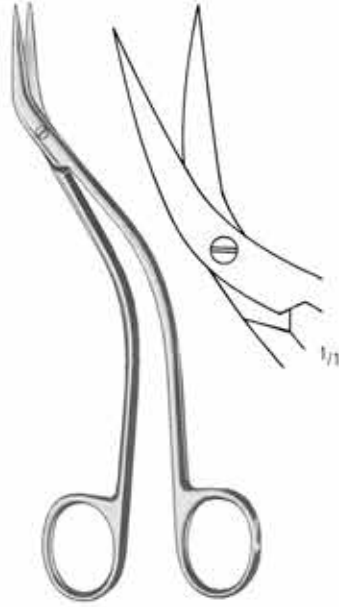

AC 236/15
 15,5 cm/6"



POTTS-DE MARTEL
AC 237/21
 21,0 cm/8¹/₄"



MILLS
AC 238/21
 21,0 cm/8¹/₄"



SCHMIEDEN-TAYLOR
 14,5 cm/5¹/₂" **AC 241/15**
 17,0 cm/6³/₄" **AC 241/17**

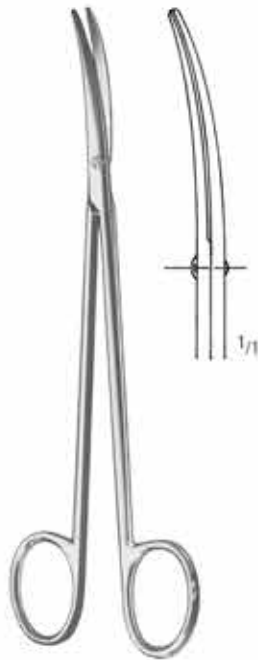

TOENNIS-ADSON
AC 247/17
 17,5 cm/7"

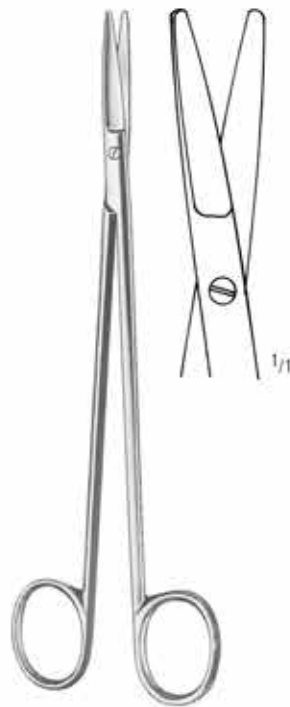

AC 248/18
 18,0 cm/7"

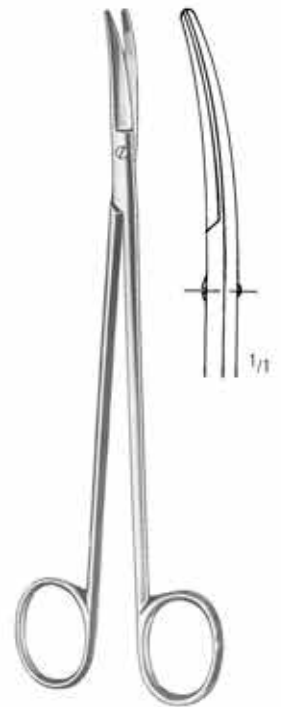

TOENNIS
AC 249/18
 18,0 cm/7"

SCHEREN SCISSORS TIJERAS CISEAUX FORBICI

Scheren für Gefäß- und Neurochirurgie
 Scissors for Vascular and Neuro Surgery
 Tijeras para cirugía vasculares y neurocirugía
 Ciseaux pour chirurgie vasculaire et neurochirurgie
 Forbici vascolari, Forbici per neurochirurgia

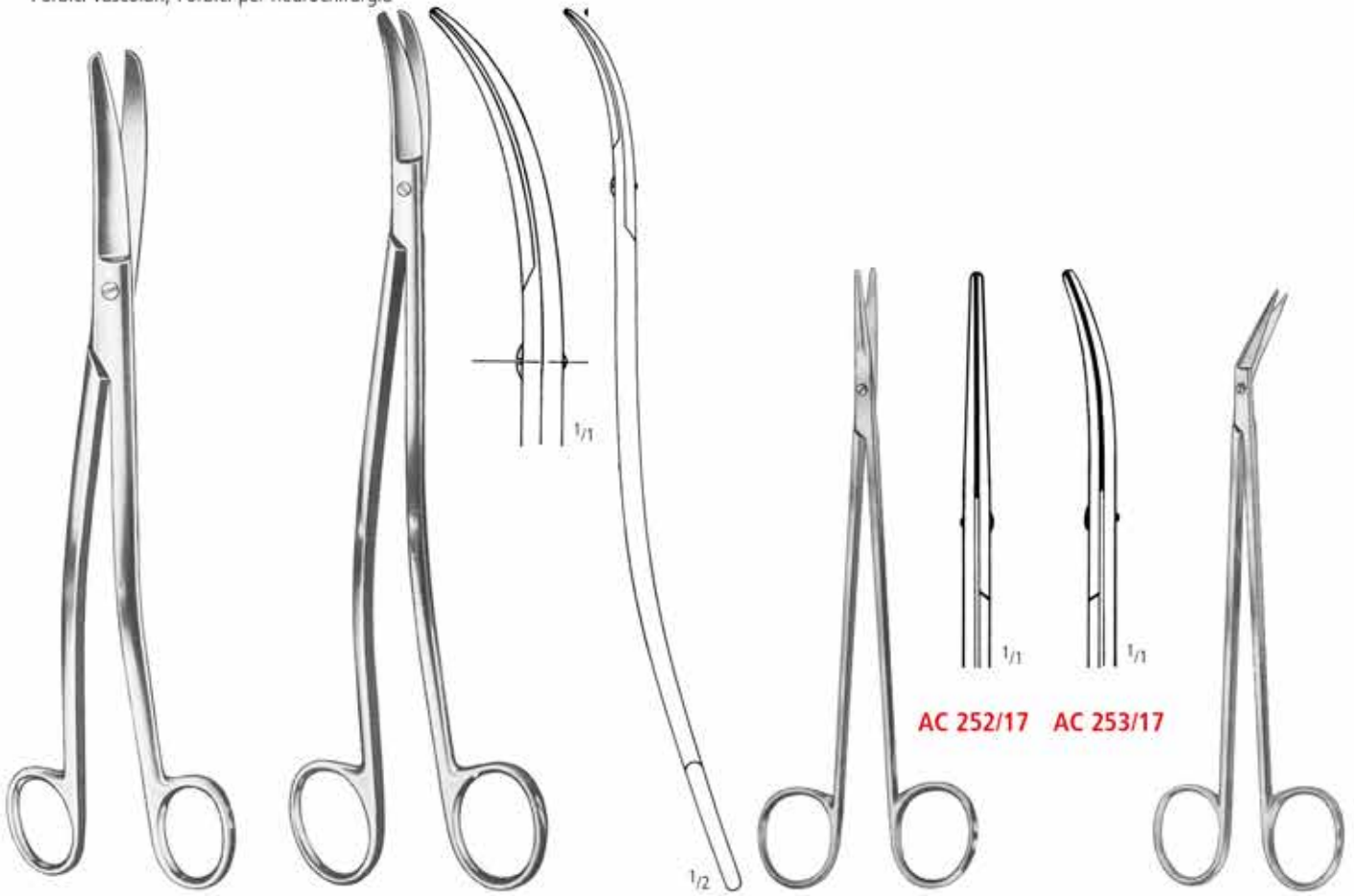

KLINKENBERGH-LOTH
AC 250/23
 23,0 cm/9"

SATINSKY
AC 251/24
 24,5 cm/9³/₄"

LINCOLN
 17,0 cm/6³/₄"

FULTON
AC 255/17
 17,0 cm/6³/₄"



AC 256/17 AC 257/17

CHURCH
 17,0 cm/6³/₄"

OLIVECRONA
AC 259/23
 23,0 cm/9"

AA
 AB
 AC
 AD
 AE
 AF
 AG
 AH
 AI
 AJ
 AK
 AL
 AM
 AN
 AO
 AP
 AQ
 AR
 AS
 AT
 AU
 AV
 AW
 AX
 AY
 AZ

AC SCHEREN SCISSORS TIJERAS CISEAUX FORBICI

Knorpel-, Lungenlappen-, Darm- und Anatomiescheren
 Cartilage-, Lobectomy-, Enterotomy- and Dissecting Scissors
 Tijeras para cartilago, lobectomia, enterótomos y disección
 Ciseaux pour le cartilage, à lobectomie, à épisiotomie et à préparation
 Forbici per cartilagini, lobectomia, episiotomia e anatomia

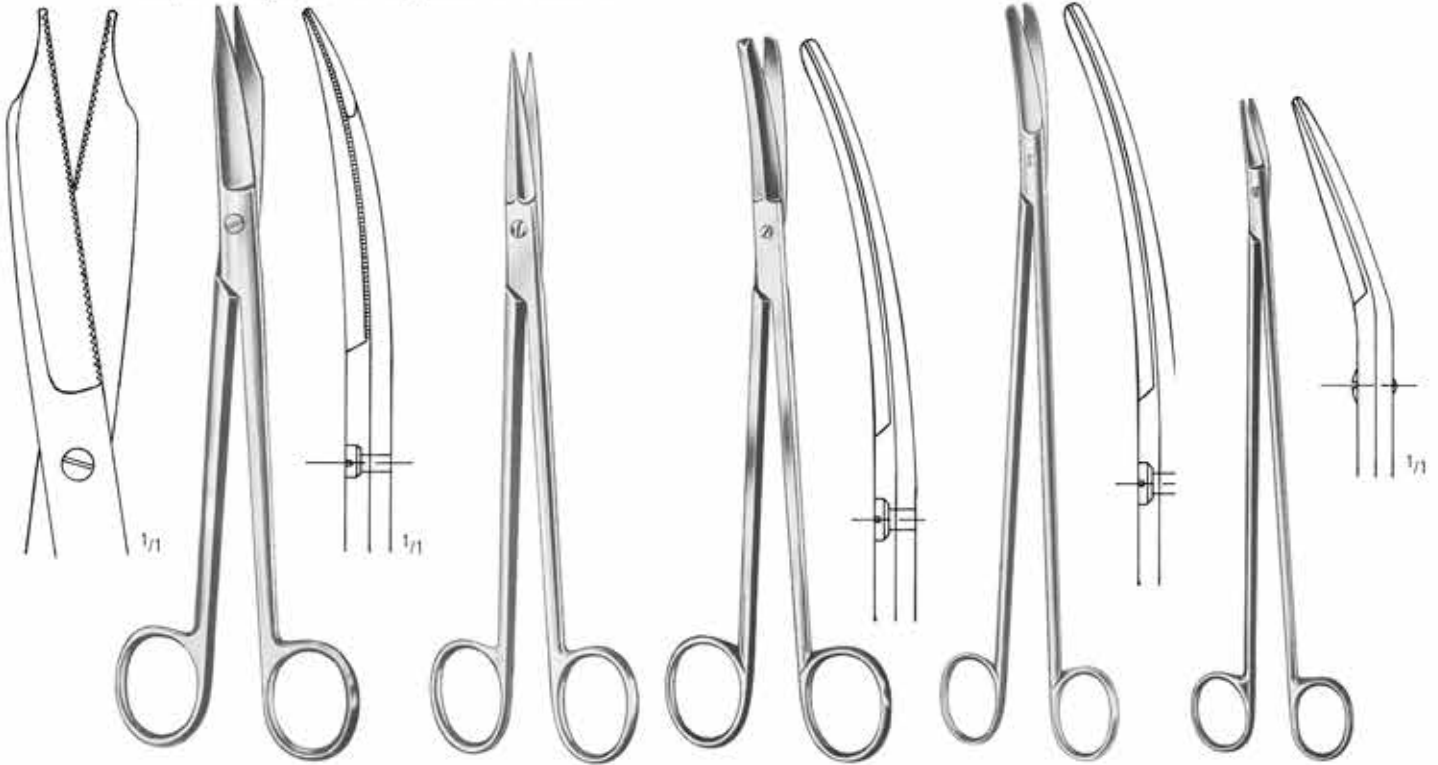

MARTIN-CARTILAGE
AC 275/20
 20,0 cm/8"

MC INDOE
AC 276/19
 19,0 cm/7¹/₂"

POTTS-SMITH
AC 277/19
 19,0 cm/7¹/₂"

CRAFOORD
AC 280/30
 30,0 cm/12"

FINOCHIETTO
AC 281/27
 27,0 cm/10³/₄"



AC 285/21
 21,0 cm/8¹/₄"

AC 286/21
 21,0 cm/8¹/₄"

AC 287/21
 21,0 cm/8¹/₄"

AC 290/11 11,0 cm/4¹/₄"
AC 290/13 13,0 cm/5"

AC 291/11
AC 291/13

SCHEREN SCISSORS TIJERAS CISEAUX FORBICI

Tonsillen- und Nasenscheren, Kropfschere
 Tonsil and Nasal Scissors, Goitre Enucleation Scissors
 Tijeras para amígdalas, Tijeras nasales, Tijeras para bocio
 Ciseaux pour les amygdales, Ciseaux nasaux, Ciseaux à goître
 Forbici per tonsille, Forbici nasali, Forbici per gozzo



PRINCE
AC 301/17
 17,5 cm/7"

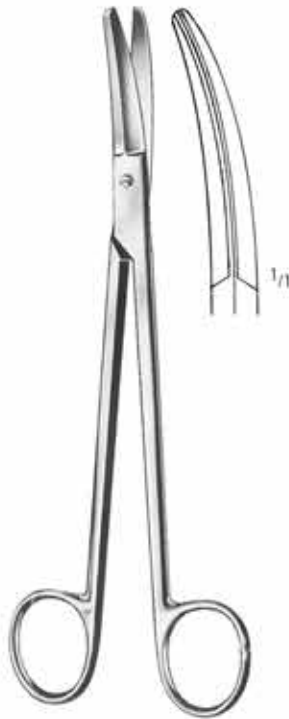

BÖTTCHER
AC 302/18
 18,0 cm/7"



GOOD
AC 303/19
 19,0 cm/7 1/2"



gezahnt
 saw edge
 dentadas
 dentelés
 dentata

GOOD-SCHWECKENDICK
AC 304/19
 19,0 cm/7 1/2"



SCHOEMAKER
AC 305/15
 15,0 cm/6"

AC 306/22
 gerade
 straight
 rectas
 droits
 rette

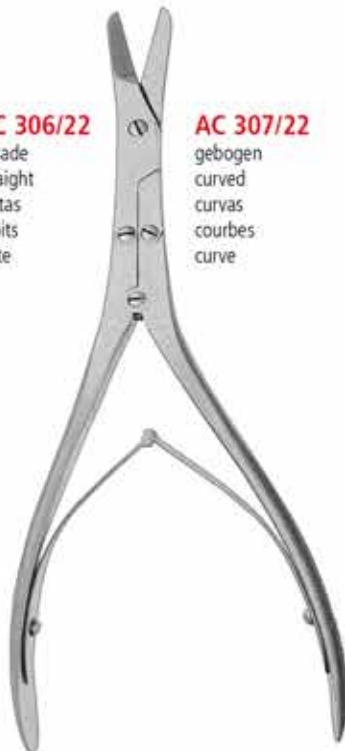

AC 307/22
 gebogen
 curved
 curvas
 courbes
 curve

CAPLAN
 22,0 cm/9"



FOMON
AC 309/13
 13,5 cm/5 1/4"



FOMON
AC 310/13
 13,5 cm/5 1/4"

AA
 AB
 AC
 AD
 AE
 AF
 AG
 AH
 AI
 AJ
 AK
 AL
 AM
 AN
 AO
 AP
 AQ
 AR
 AS
 AT
 AU
 AV
 AW
 AX
 AY
 AZ

Nasenscheren
Nasal Scissors
Tijeras nasales
Ciseaux nasaux
Forbici nasale

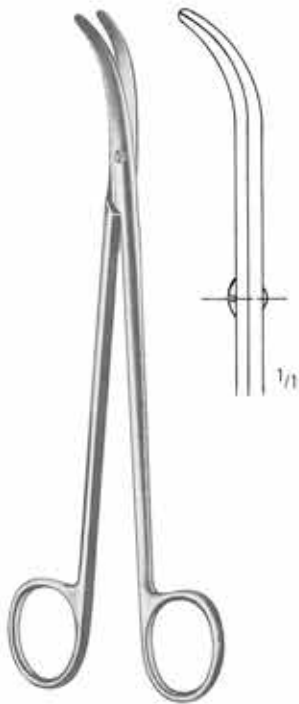

HALLE
AC 313/19
19,0 cm/7¹/₂"

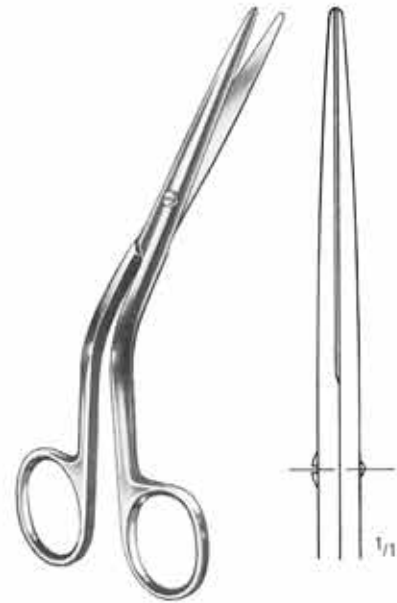

COTTLE
AC 315/16
16,0 cm/6¹/₄"



HEYMANN
AC 317/18
18,0 cm/7"



HEYMANN
AC 318/19
19,5 cm/7³/₄"

SCHEREN SCISSORS TIJERAS CISEAUX FORBICI

Episiotomie- und Nabelschnurscheren
 Episiotomy and Umbilical Scissors
 Tijeras para episiotomia, Tijeras umbilicales
 Ciseaux à épisiotomie et pour le cordon ombilical
 Forbici per episiotomia, Forbici ombelicale



BRAUN-STADLER
AC 351/14
 14,0 cm/5½"



BRAUN-STADLER
 20,0 cm/8" **AC 351/20**
 22,0 cm/8¾" **AC 351/22**



WALDMANN
AC 353/18
 18,0 cm/7"



AC 354/20
 20,0 cm/8"



MOD. USA
AC 360/10
 10,5 cm/4¼"



SCHUMACHER
AC 362/16
 16,0 cm/6¼"



BUSCH
 13,0 cm/5" **AC 365/13**
 16,0 cm/6¼" **AC 365/16**

AA
 AB
AC
 AD
 AE
 AF
 AG
 AH
 AI
 AJ
 AK
 AL
 AM
 AN
 AO
 AP
 AQ
 AR
 AS
 AT
 AU
 AV
 AW
 AX
 AY
 AZ

Feine chirurgische Scheren
 Fine Operating Scissors
 Tijeras finas para cirugía
 Ciseaux fins à chirurgie
 Forbici fini per chirurgia



WAGNER
 12,0 cm/4³/₄"

gerade
 straight
 rectas
 droits
 rette



Fig. 1
AC 404/01



Fig. 2
AC 404/02



Fig. 3
AC 404/03

gebogen
 curved
 curvas
 courbes
 curve



Fig. 1
AC 405/01



Fig. 2
AC 405/02



Fig. 3
AC 405/03



AC 408/11
 11,0 cm/4¹/₃"



AC 409/11
 11,0 cm/4¹/₃"

SCHEREN SCISSORS TIJERAS CISEAUX FORBICI

Feine Scheren
Fine Scissors
Tijeras finas
Ciseaux fins
Forbici fini

AA
AB
AC
AD
AE
AF
AK
AL
AM
AO
AP
AR
KA
KD
KU
KY

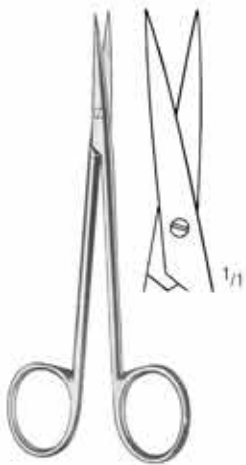

AC 410/11
11,5 cm/4 1/2"

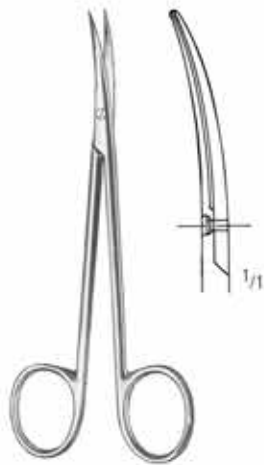

AC 411/11
11,5 cm/4 1/2"

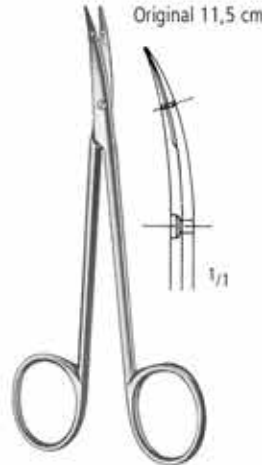

LITTLER
AC 412/11 11,5 cm/4 1/2"
AC 412/14 14,0 cm/5 1/2"

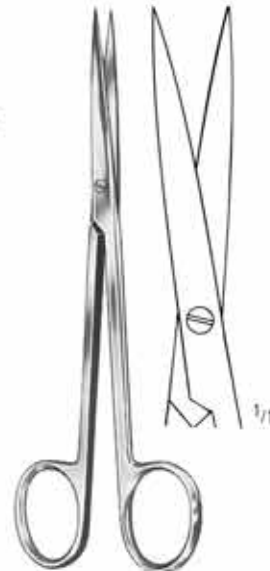

BROPHY (SULLIVAN)
AC 414/14
14,5 cm/5 3/4"

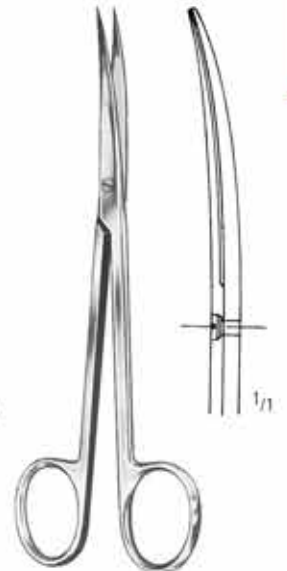

AC 415/14
14,5 cm/5 3/4"



AC 418/13
13,0 cm/5"

AC 419/13
13,0 cm/5"



AC 422/10 10,5 cm/4 1/4"
AC 422/11 11,5 cm/4 1/2"



AC 423/10
AC 423/11



AC 424/11
11,5 cm/4 1/2"

AC SCHEREN SCISSORS TIJERAS CISEAUX FORBICI

Feine Scheren
 Fine Scissors
 Tijeras finas
 Ciseaux fins
 Forbici fini

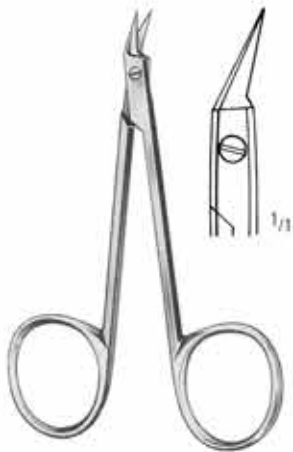

O'BRIEN
AC 427/09
 9,0 cm/3 1/2"



WALTON
AC 429/10
 10,0 cm/4"

sehr fein
 extra delicate
 muy finas
 très fin
 molto sottile



MOD. BONN
AC 430/08
 8,0 cm/3"

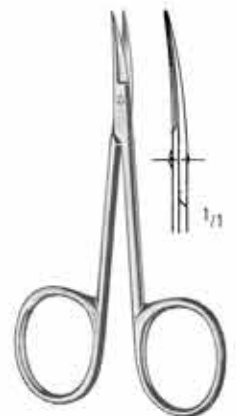

AC 431/08
 8,0 cm/3"

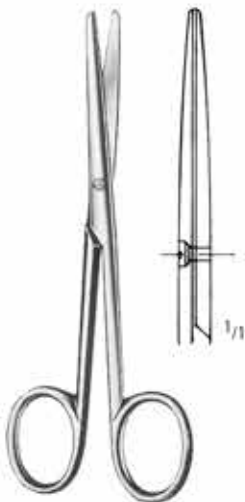

LANDOLT
AC 434/12
 12,5 cm/5"



LANDOLT
AC 435/12
 12,5 cm/5"

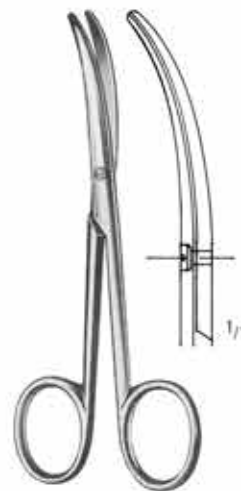

LANDOLT
AC 436/12
 12,5 cm/5"



LANDOLT
AC 437/12
 12,5 cm/5"

SCHEREN SCISSORS TIJERAS CISEAUX FORBICI

Augenscheren
Eye Scissors
Tijeras oculares
Ciseaux oculaires
Forbici oftalmologici



11,5 cm/4 1/2"

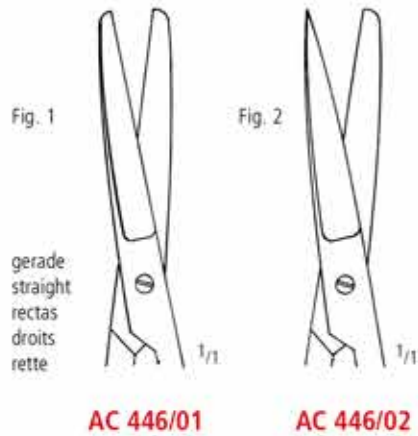

gerade
straight
rectas
droits
rette

AC 446/01

AC 446/02

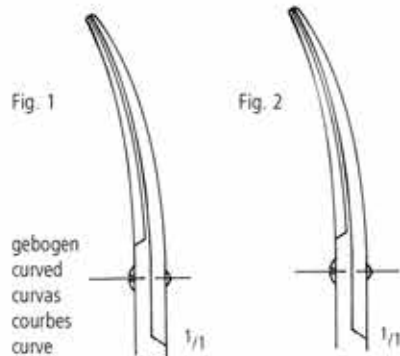

gebogen
curved
curvas
courbes
curve

AC 447/01

AC 447/02



AC 448/11

11,5 cm/4 1/2"

AC 449/11

11,5 cm/4 1/2"

Irisscheren
Iris Scissors
Tijeras para iridectomia
Ciseaux à iridectomie
Forbici per iridectomia

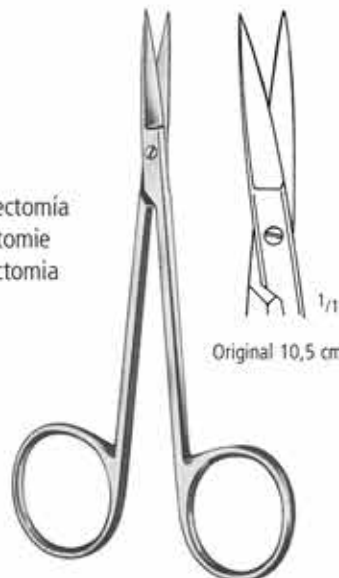

Original 10,5 cm

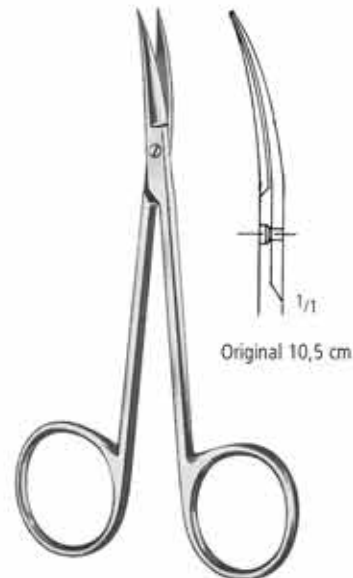

Original 10,5 cm

9,0 cm/3 1/2"	AC 450/09	AC 451/09
10,5 cm/4 1/4"	AC 450/10	AC 451/10
11,5 cm/4 1/2"	AC 450/11*	AC 451/11*

AA
AB
AC
AD
AE
AF
AG
AH
AI
AJ
AK
AL
AM
AN
AO
AP
AQ
AR
AS
AT
AU
AV
AW
AX
AY
AZ

AC SCHEREN SCISSORS TIJERAS CISEAUX FORBICI

Augenscheren
Eye Scissors
Tijeras oculares
Ciseaux oculaires
Forbici oftalmologici

mit großen Ringen
with large bows
con anillos grandes
avec grands anneaux
con anelli grandi

Strabismusscheren
Strabismus Scissors
Tijeras para estrabismos
Ciseaux à strabisme
Forbici per strabismo

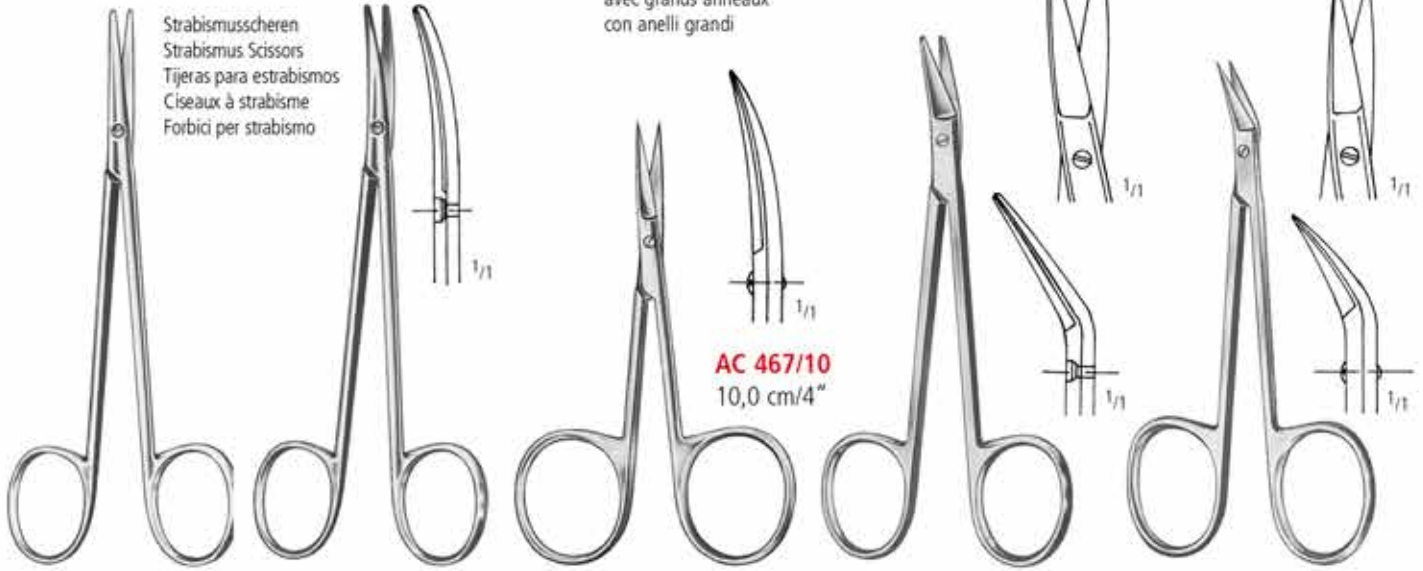

AC 460/11*
11,5 cm/4 1/2"

AC 461/11*
11,5 cm/4 1/2"

AC 466/10
10,0 cm/4"

GRAEFE
AC 469/10
10,5 cm/4 1/4"

WILMER
AC 471/10
10,0 cm/4"

Sehnenscheren
Tenotomy Scissors
Tijeras para tenotomía
Ciseaux à ténatomie
Forbici per tenotomia

Original 11,5 cm

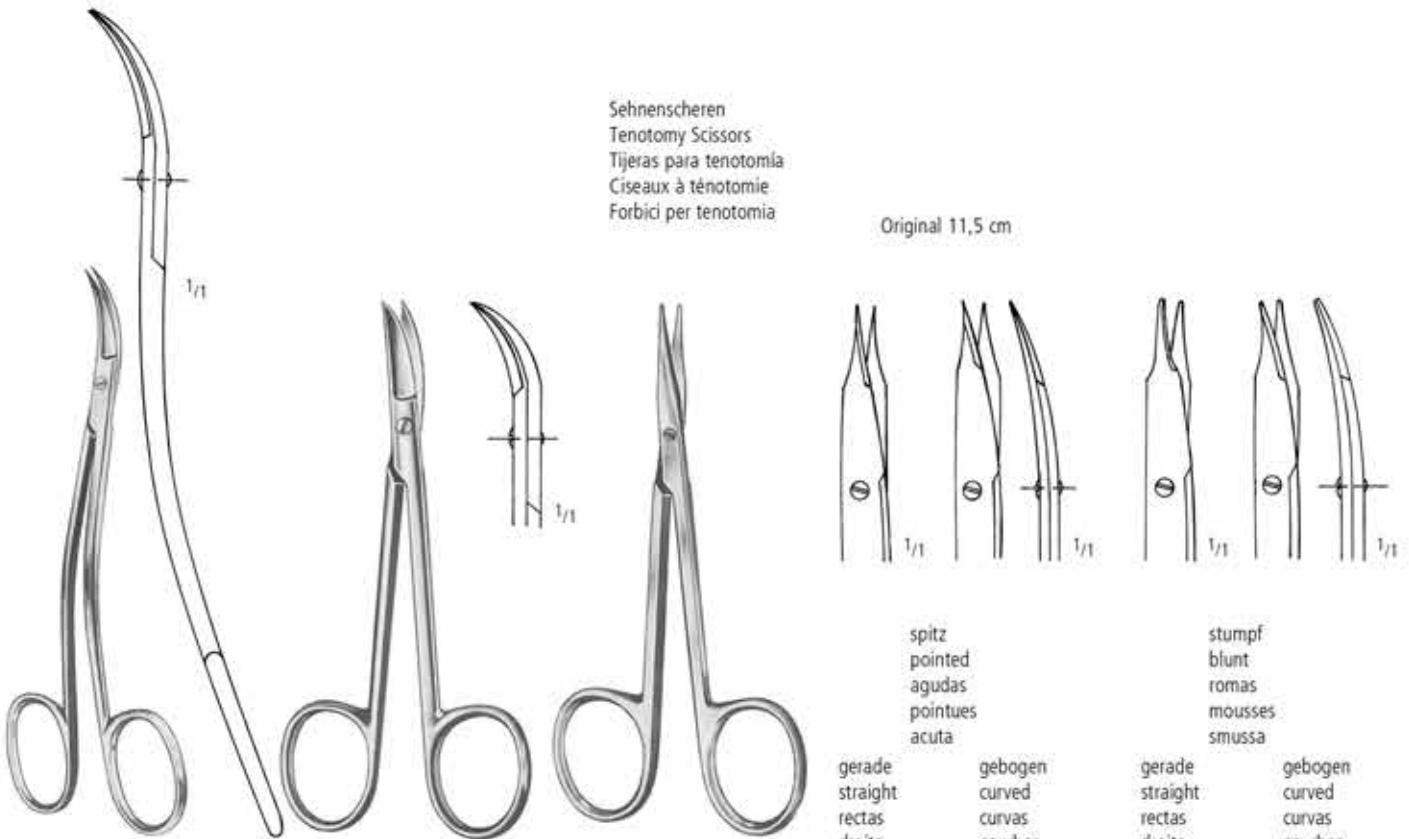

spitz
pointed
agudas
pointues
acuta

stumpf
blunt
romas
mousses
smussa

gerade
straight
rectas
droits
rette

gebogen
curved
curvas
courbes
curve

gerade
straight
rectas
droits
rette

gebogen
curved
curvas
courbes
curve

LA GRANGE
AC 472/11
11,5 cm/4 1/2"

CHADWICK
AC 473/11
11,0 cm/4 1/3"

STEVENS
10,5 cm/4 1/4"
11,5 cm/4 1/2"

AC 474/10
AC 474/11

AC 475/10
AC 475/11

AC 476/10
AC 476/11*

AC 477/10
AC 477/11*

SCHEREN SCISSORS TIJERAS CISEAUX FORBICI

Augenscheren
Eye Scissors
Tijeras oculares
Ciseaux oculaires
Forbici oftalmologici

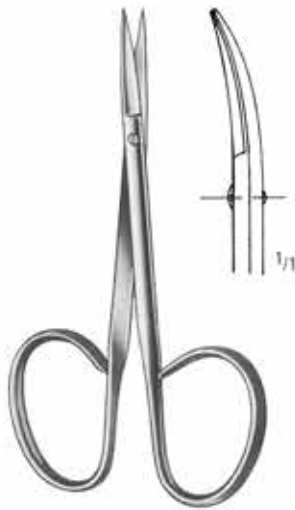

gerade
straight
rectas
droits
rette

gebogen
curved
curvas
courbes
curve

RIBBON
AC 488/10 AC 489/10
10,0 cm/4"



gerade
straight
rectas
droits
rette

gebogen
curved
curvas
courbes
curve

RIBBON
AC 490/10 AC 491/10
10,0 cm/4"

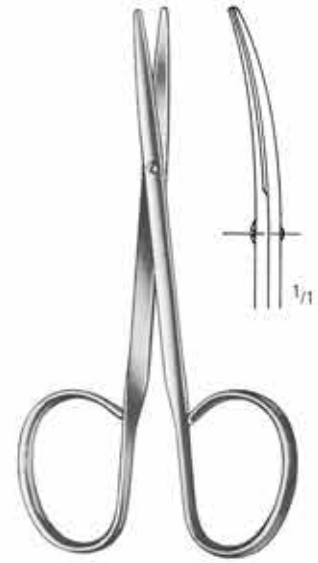

gerade
straight
rectas
droits
rette

gebogen
curved
curvas
courbes
curve

RIBBON
AC 492/10 AC 493/10
10,0 cm/4"

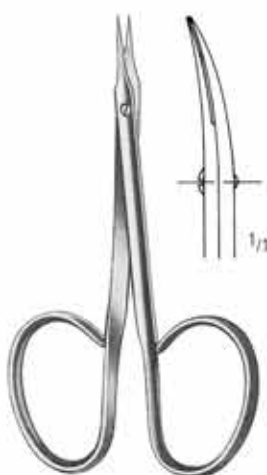

gerade
straight
rectas
droits
rette

gebogen
curved
curvas
courbes
curve

RIBBON
AC 494/09 AC 495/09
9,5 cm/3¾"

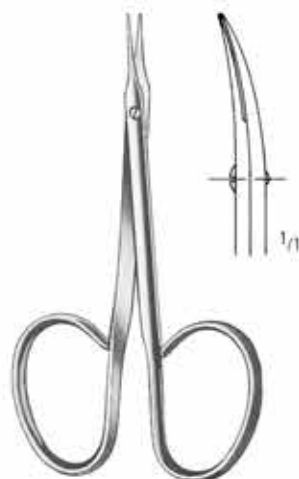

gerade
straight
rectas
droits
rette

gebogen
curved
curvas
courbes
curve

RIBBON
AC 496/09 AC 497/09
9,5 cm/3¾"

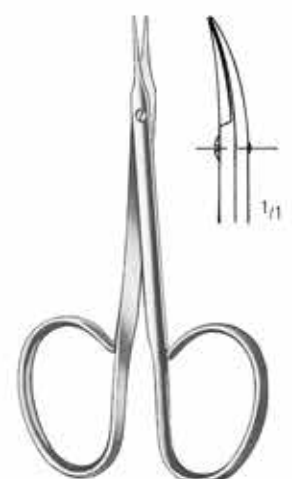

gerade
straight
rectas
droits
rette

gebogen
curved
curvas
courbes
curve

RIBBON
AC 498/09 AC 499/09
9,5 cm/3¾"

AA
AB
AC
AD
AE
AF
AG
AH
AI
AJ
AK
AL
AM
AN
AO
AP
AQ
AR
AS
AT
AU
AV
AW
AX
AY
AZ
BA
BB
BC
BD
BE
BF
BG
BH
BI
BJ
BK
BL
BM
BN
BO
BP
BQ
BR
BS
BT
BU
BV
BW
BX
BY
BZ
CA
CB
CC
CD
CE
CF
CG
CH
CI
CJ
CK
CL
CM
CN
CO
CP
CQ
CR
CS
CT
CU
CV
CW
CX
CY
CZ
DA
DB
DC
DD
DE
DF
DG
DH
DI
DJ
DK
DL
DM
DN
DO
DP
DQ
DR
DS
DT
DU
DV
DW
DX
DY
DZ
EA
EB
EC
ED
EE
EF
EG
EH
EI
EJ
EK
EL
EM
EN
EO
EP
EQ
ER
ES
ET
EU
EV
EW
EX
EY
EZ
FA
FB
FC
FD
FE
FF
FG
FH
FI
FJ
FK
FL
FM
FN
FO
FP
FQ
FR
FS
FT
FU
FV
FW
FX
FY
FZ
GA
GB
GC
GD
GE
GF
GG
GH
GI
GJ
GK
GL
GM
GN
GO
GP
GQ
GR
GS
GT
GU
GV
GW
GX
GY
GZ
HA
HB
HC
HD
HE
HF
HG
HH
HI
HJ
HK
HL
HM
HN
HO
HP
HQ
HR
HS
HT
HU
HV
HW
HX
HY
HZ
IA
IB
IC
ID
IE
IF
IG
IH
II
IJ
IK
IL
IM
IN
IO
IP
IQ
IR
IS
IT
IU
IV
IW
IX
IY
IZ
JA
JB
JC
JD
JE
JF
JG
JH
JI
JJ
JK
JL
JM
JN
JO
JP
JQ
JR
JS
JT
JU
JV
JW
JX
JY
JZ
KA
KB
KC
KD
KE
KF
KG
KH
KI
KJ
KK
KL
KM
KN
KO
KP
KQ
KR
KS
KT
KU
KV
KW
KX
KY
KZ
LA
LB
LC
LD
LE
LF
LG
LH
LI
LJ
LK
LL
LM
LN
LO
LP
LQ
LR
LS
LT
LU
LV
LW
LX
LY
LZ
MA
MB
MC
MD
ME
MF
MG
MH
MI
MJ
MK
ML
MM
MN
MO
MP
MQ
MR
MS
MT
MU
MV
MW
MX
MY
MZ
NA
NB
NC
ND
NE
NF
NG
NH
NI
NJ
NK
NL
NM
NN
NO
NP
NQ
NR
NS
NT
NU
NV
NW
NX
NY
NZ
OA
OB
OC
OD
OE
OF
OG
OH
OI
OJ
OK
OL
OM
ON
OO
OP
OQ
OR
OS
OT
OU
OV
OW
OX
OY
OZ
PA
PB
PC
PD
PE
PF
PG
PH
PI
PJ
PK
PL
PM
PN
PO
PP
PQ
PR
PS
PT
PU
PV
PW
PX
PY
PZ
QA
QB
QC
QD
QE
QF
QG
QH
QI
QJ
QK
QL
QM
QN
QO
QP
QQ
QR
QS
QT
QU
QV
QW
QX
QY
QZ
RA
RB
RC
RD
RE
RF
RG
RH
RI
RJ
RK
RL
RM
RN
RO
RP
RQ
RR
RS
RT
RU
RV
RW
RX
RY
RZ
SA
SB
SC
SD
SE
SF
SG
SH
SI
SJ
SK
SL
SM
SN
SO
SP
SQ
SR
SS
ST
SU
SV
SW
SX
SY
SZ
TA
TB
TC
TD
TE
TF
TG
TH
TI
TJ
TK
TL
TM
TN
TO
TP
TQ
TR
TS
TT
TU
TV
TW
TX
TY
TZ
UA
UB
UC
UD
UE
UF
UG
UH
UI
UJ
UK
UL
UM
UN
UO
UP
UQ
UR
US
UT
UU
UV
UW
UX
UY
UZ
VA
VB
VC
VD
VE
VF
VG
VH
VI
VJ
VK
VL
VM
VN
VO
VP
VQ
VR
VS
VT
VU
VV
VW
VX
VY
VZ
WA
WB
WC
WD
WE
WF
WG
WH
WI
WJ
WK
WL
WM
WN
WO
WP
WQ
WR
WS
WT
WU
WV
WW
WX
WY
WZ
XA
XB
XC
XD
XE
XF
XG
XH
XI
XJ
XK
XL
XM
XN
XO
XP
XQ
XR
XS
XT
XU
XV
XW
XX
XY
XZ
YA
YB
YC
YD
YE
YF
YG
YH
YI
YJ
YK
YL
YM
YN
YO
YP
YQ
YR
YS
YT
YU
YV
YW
YX
YY
YZ
ZA
ZB
ZC
ZD
ZE
ZF
ZG
ZH
ZI
ZJ
ZK
ZL
ZM
ZN
ZO
ZP
ZQ
ZR
ZS
ZT
ZU
ZV
ZW
ZX
ZY
ZZ

AC SCHEREN SCISSORS TIJERAS CISEAUX FORBICI

Ligaturscheren
Ligature Scissors
Tijeras para ligaduras
Ciseaux à ligatures
Forbici per legatura



SPENCER

9,0 cm/3½"
10,5 cm/4¼"
12,5 cm/5" **AC 500/09**
AC 500/10
AC 500/13



SPENCER-DELICATE

AC 501/11
11,0 cm/4⅓"



LITTAUER

AC 502/14
14,0 cm/5½"



AC 503/16
16,0 cm/6¼"



EISELSBERG
AC 504/12
11,0 cm/4⅓"



SCHOEMAKER-LOTH
AC 505/12
12,5 cm/5"



AC 506/11
11,5 cm/4½"

SCHEREN SCISSORS TIJERAS CISEAUX FORBICI

Ligaturscheren
Ligature Scissors
Tijeras para ligaduras
Ciseaux à ligatures
Forbici per legatura

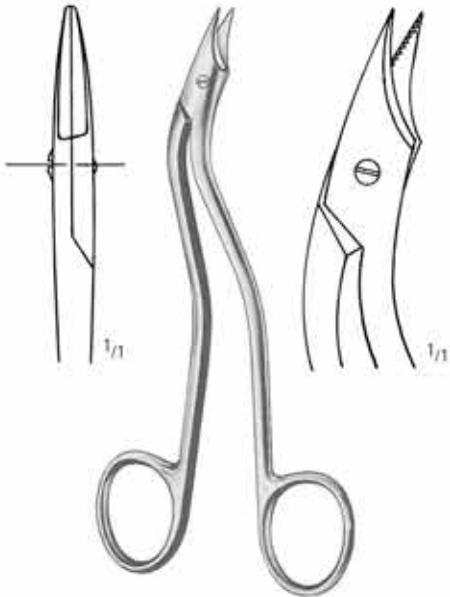

HEATH
AC 507/15
15,0 cm/6"



gezahnt
saw edge
dentadas
dentelés
dentata

AC 509/12
12,0 cm/4³/₄"



SHORTBENT
AC 513/09
9,0 cm/3¹/₂"



NORTHBENT
AC 514/12
12,5 cm/5"



BUCK
14,5 cm/5³/₄" **AC 516/14**
18,0 cm/7" **AC 516/18**

AA

AB

AC

AD

AE

AF

AK

AL

AM

AO

AP

AR

KA

KD

KU

KY

AC SCHEREN SCISSORS TIJERAS CISEAUX FORBICI

Draht- und Kronenscheren
 Wire Cutting and Crown Scissors
 Cizallas para cortar alambre, Tijeras para coronas
 Cisailles pour fils, Ciseaux à couronnes
 Forbici per filo metallico e per corone



HARVEY
AC 520/12
 12,5 cm/5"

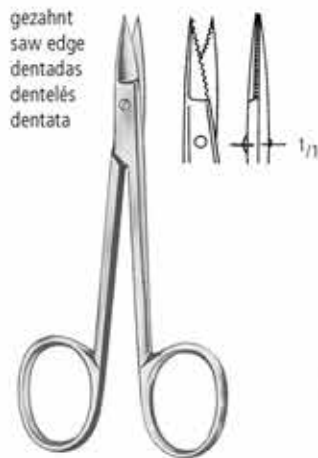

SCHUKNECHT
AC 521/10
 10,0 cm/4"



AC 522/11
 11,0 cm/4 1/3"



UNIVERSAL
AC 524/12
 12,0 cm/4 3/4"



SMITH
AC 525/17
 17,5 cm/7"



BEEBEE
 10,5 cm/4 1/4"
 gerade - straight - rectas - droits - rette

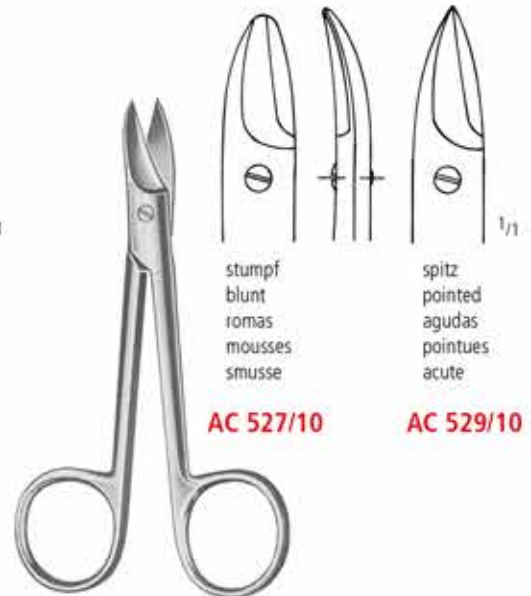

BEEBEE
 10,5 cm/4 1/4"
 gebogen - curved - curvas - courbes - curve

SCHEREN SCISSORS TIJERAS CISEAUX FORBICI

Kronenscheren
Crown Scissors
Tijeras para coronas
Ciseaux à couronnes
Forbici per corone

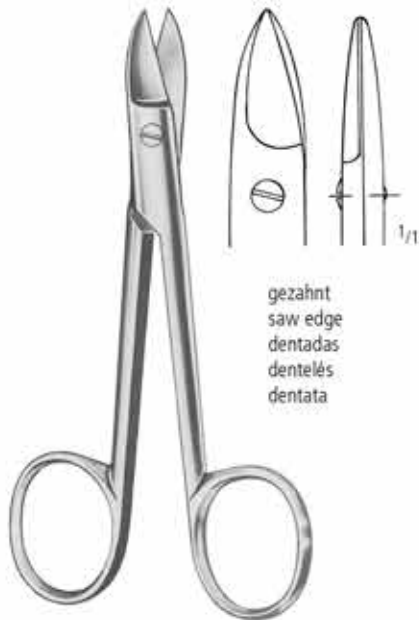

gezahnt
saw edge
dentadas
dentelés
dentata

BEEBEE
AC 530/12
12,0 cm/4³/₄"

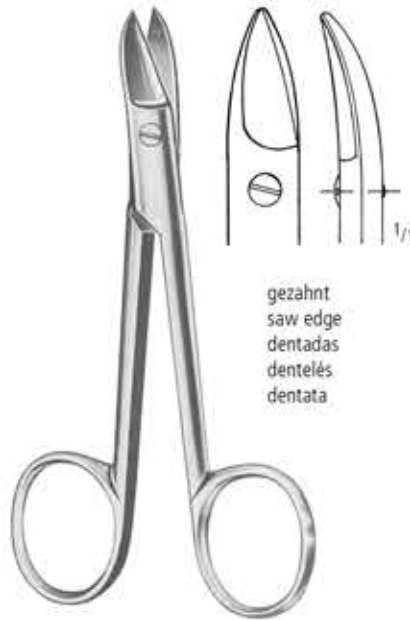

gezahnt
saw edge
dentadas
dentelés
dentata

BEEBEE
AC 531/12
12,0 cm/4³/₄"



AC 535/10
10,5 cm/4¹/₄"



AC 536/09
9,0 cm/3¹/₂"



AC 537/09
9,0 cm/3¹/₂"



AC 538/11
11,0 cm/4¹/₃"



AC 539/11
11,0 cm/4¹/₃"

AA
AB
AC
AD
AE
AF
AK
AL
AM
AO
AP
AR
KA
KD
KU
KY

Verband- und Kleiderscheren
 Bandage and Clothing Scissors
 Tijeras para vendajes y vestidos
 Ciseaux pour pansements
 Forbici per bendaggi



AC 551/14
 14,5 cm/5³/₄"

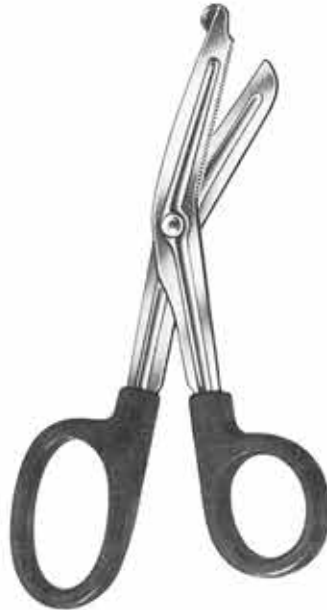

AC 551/16
 16,0 cm/6¹/₄"



UNIVERSAL
AC 551/18
 18,0 cm/7"



BERGMANN
AC 553/23
 23,0 cm/9"



LANGE
AC 554/18
 18,0 cm/7"



AC 555/17
 17,0 cm/6³/₄"

gezahnt
 saw edge
 dentadas
 dentelés
 dentata

SCHEREN SCISSORS TIJERAS CISEAUX FORBICI

Verband- und Kleiderscheren
Bandage and Clothing Scissors
Tijeras para vendajes y vestidos
Ciseaux pour pansements
Forbici per bendaggi



SMITH (Mod. USA)
18,0 cm/7"
20,0 cm/8"
23,0 cm/9"
AC 560/18
AC 560/20
AC 560/23



LORENZ
AC 561/23
23,0 cm/9"



KNOWLES
AC 563/14
14,0 cm/5 1/2"



für Finger
for fingers
para dedos
pour doigts
per dita

KNOWLES
AC 564/14
14,0 cm/5 1/2"



LISTER
18,5 cm/7 1/3"
21,0 cm/8 1/4"
AC 565/18
AC 565/21



gezahnt
saw edge
dentadas
dentelés
dentata

LISTER-EXCENTRIC
16,0 cm/6 1/4"
19,0 cm/7 1/2"
AC 566/16
AC 566/19

AA
AB
AC
AD
AE
AF
AK
AL
AM
AO
AP
AR
KA
KD
KU
KY

AC SCHEREN SCISSORS TIJERAS CISEAUX FORBICI

Verbandscheren, Gippscheren
 Bandage Scissors, Plaster-of-Paris Shears
 Tijeras para vendajes, Cizallas para vendajes enyesados
 Ciseaux pour pansements, Cisailles pour appareils plâtrés
 Forbici per bendaggi e per apparecchi gessati



LISTER

9,0 cm/3 1/2"
 11,0 cm/4 1/3"
 14,0 cm/5 1/2"
 15,5 cm/6"
 18,0 cm/7"
 20,0 cm/8"

AC 567/09
AC 567/11
AC 567/14
AC 567/15
AC 567/18
AC 567/20



E:

20,0 cm/8"
 22,0 cm/8 3/4"

AC 569/20
AC 569/22



SEUTIN
AC 571/23
 23,0 cm/9"



gezahnt
 saw edge
 dentadas
 dentelés
 dentata

AC 573/20
 20,0 cm/8"



BRUNS
 24,0 cm/9 1/2"

gezahnt
 saw edge
 dentadas
 dentelés
 dentata

AC 579/24

glatt
 smooth
 liso
 lisse
 liscio

AC 580/24

SCHEREN SCISSORS TIJERAS CISEAUX FORBICI

Nagelscheren, Hautscheren, Nagelspaltscheren
 Nail Scissors, Cuticle Scissors, Nail Splitting Scissors
 Tijeras para uñas, Tijeras cuticulares, Tijeras para uñas encarnadas
 Ciseaux à ongles, Ciseaux à envies, Ciseaux pour ongles incarnés
 Forbici per unghie, Forbici per pelle, Forbici per unghie incarnate

AA
AB
AC
AD
AE
AF
AK
AL
AM
AO
AP
AR
KA
KD
KY



9,0 cm/3 1/2"
10,5 cm/4 1/4"

AC 608/09
AC 608/10

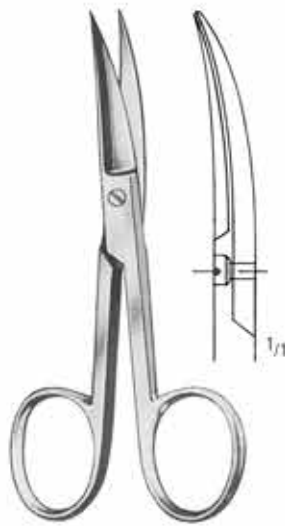

AC 609/09
AC 609/10



AC 610/09
AC 610/10

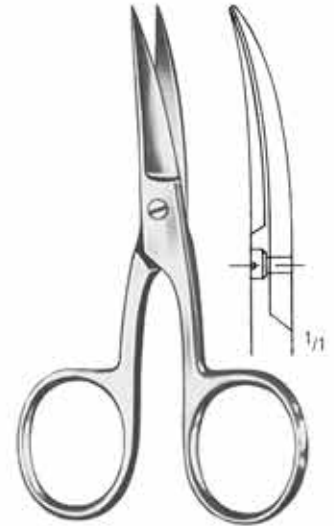

AC 611/09
AC 611/10



AC 612/10
AC 612/11

10,0 cm/4"
11,0 cm/4 1/3"

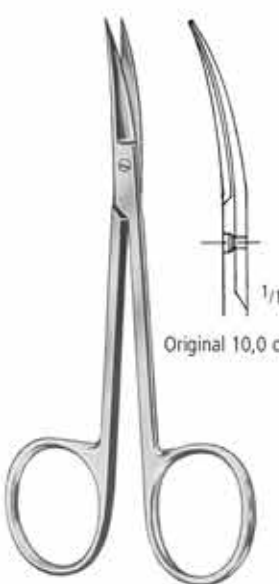

AC 613/10
AC 613/11

Original 10,0 c



AC 624/11
10,5 cm/4 1/4"



AC 626/11
10,5 cm/4 1/4"



KÖNIG
AC 628/13 13,0 cm/5"
AC 628/15 15,0 cm/6"

AC SCHEREN SCISSORS TIJERAS CISEAUX FORBICI

Zahnfleischscheren
Gum Scissors
Tijeras para encias
Ciseaux à gencives
Forbici per gengiva

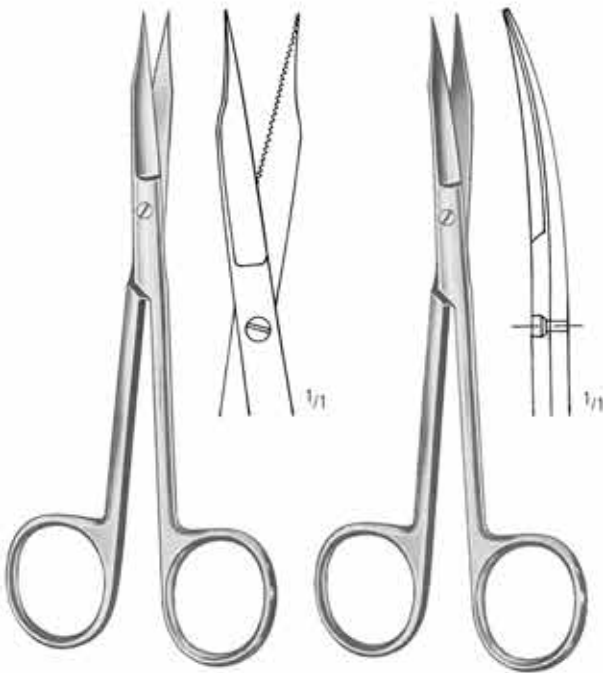

GOLDMAN-FOX
AC 630/13
13,0 cm/5"

AC 631/13
13,0 cm/5"

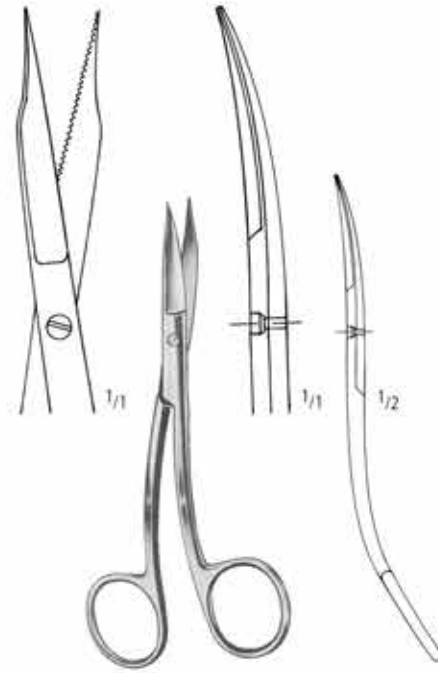

GOLDMAN-FOX (SPEZIAL)
AC 635/13
13,0 cm/5"

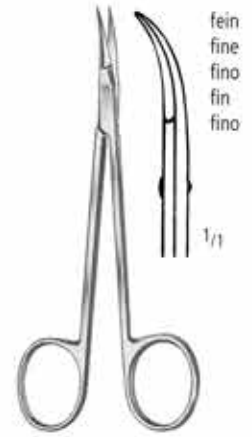

AC 637/11
11,5 cm/4 1/2"

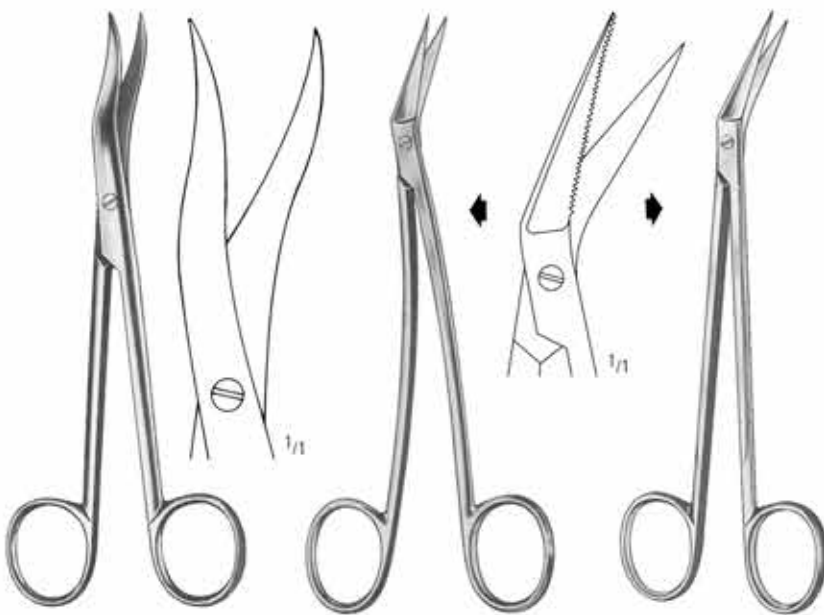

AC 639/16
16,0 cm/6 1/4"

LOCKLIN
AC 640/16
16,5 cm/6 1/2"

LOCKLIN
AC 641/16
16,5 cm/6 1/2"

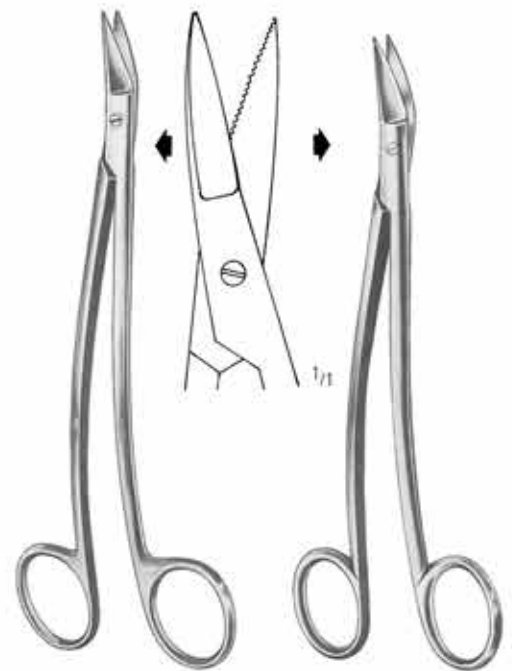

DEAN-DELICATE
AC 642/17
17,0 cm/6 3/4"

DEAN
AC 643/17
17,0 cm/6 3/4"

SCHEREN SCISSORS TIJERAS CISEAUX FORBICI

Zahnfleischscheren
Gum Scissors
Tijeras para encias
Ciseaux à gencives
Forbici per gengiva



QUINBY

AC 646/12
12,0 cm/4³/₄"

AC 647/12
12,0 cm/4³/₄"



STANDARD

AC 648/11
11,0 cm/4¹/₃"

AC 649/11
11,0 cm/4¹/₃"

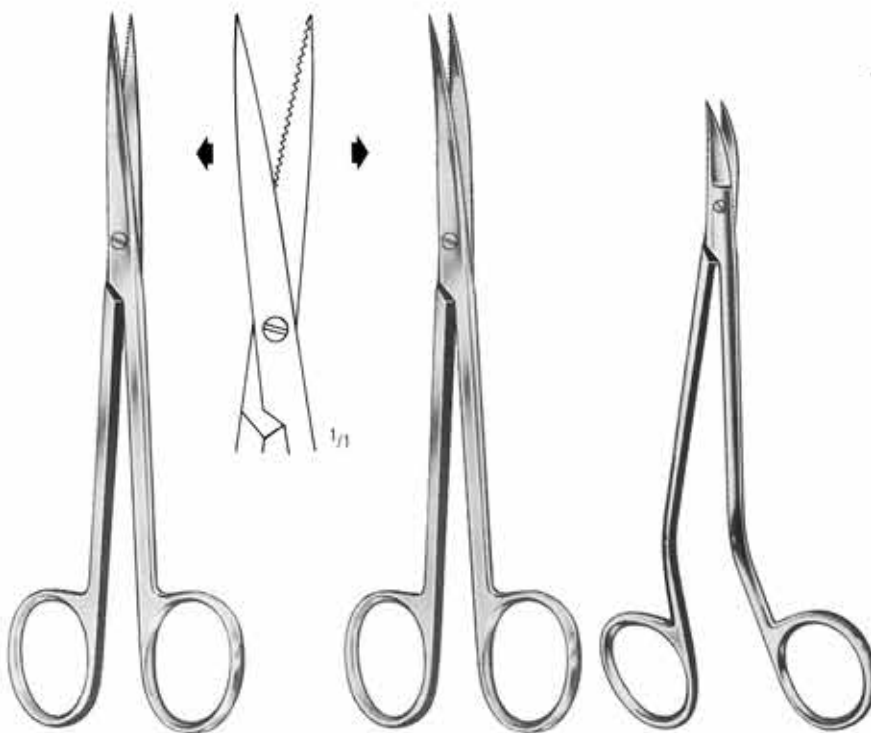

SULLIVAN

AC 650/14
14,5 cm/5³/₄"

AC 651/14
14,5 cm/5³/₄"

NEUMANN

AC 653/12
12,5 cm/5"

Weitere Zahnfleischscheren, siehe Seiten
108, 110, 112, 124, 127, 128, 161, 162

Other Gum Scissors see pages
108, 110, 112, 124, 127, 128, 161, 162

Tijeras para encias similares véanse páginas
108, 110, 112, 124, 127, 128, 161, 162

Ciseaux à gencives ultérieure voir pages
108, 110, 112, 124, 127, 128, 161, 162

Forbici per gengiva ulteriori vedere pagine
108, 110, 112, 124, 127, 128, 161, 162

AA
AB
AC
AD
AE
AF
AK
AL
AM
AO
AP
AR
KA
KD
KU
KY

AC SCHEREN SCISSORS TIJERAS CISEAUX FORBICI

Iridektomiescheren
Iris Scissors
Pinzas-tijeras para iridectomía
Ciseaux à iridectomie
Forbici per iridectomia



Fig. 1



Fig. 2



Fig. 3

NOYES

12,0 cm/4³/₄"

- Fig. 1 **AC 750/12**
- Fig. 2 **AC 752/12**
- Fig. 3 **AC 754/12**

- Fig. 1 **AC 751/12**
- Fig. 2 **AC 753/12**
- Fig. 3 **AC 755/12**



1/11



1/11

AC 760/11



1/11

AC 762/11



1/11

AC 764/11



1/11

BARRAQUER

5,5 cm/2¹/₄"

- 5 mm **AC 768/05**
- 7 mm **AC 768/07**
- 10 mm **AC 768/10**

WECKER

11,0 cm/4¹/₃"



CASTROVIEJO
AC 770/00
9,0 cm/3¹/₂"



AC 770/02



AC 770/03



AC 771/09



AC 772/09



1/11

AC 773/10

spitz
pointed
agudas
pointues
acute

CASTROVIEJO
10,0 cm/4"



1/11

AC 775/10

stumpf
blunt
romas
mousses
smusse

CASTROVIEJO
10,0 cm/4"

SCHEREN SCISSORS TIJERAS CISEAUX FORBICI

Nachstarscheren
 Secondary Cataract Scissors
 Pinzas-tijeras para catarata secundaria
 Pincas ciseaux pour le cataracte secondaire
 Pinze-forbici per cataratta secundaria

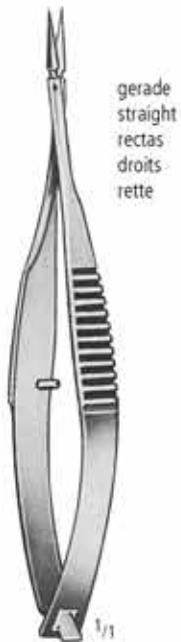

gerade
 straight
 rectas
 droits
 rette

AC 776/01
 8,5 cm/3 1/3"

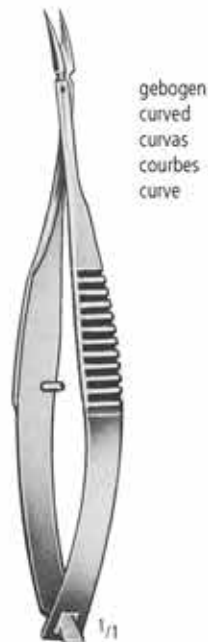

gebogen
 curved
 curvas
 courbes
 curve

AC 776/02
 8,5 cm/3 1/3"

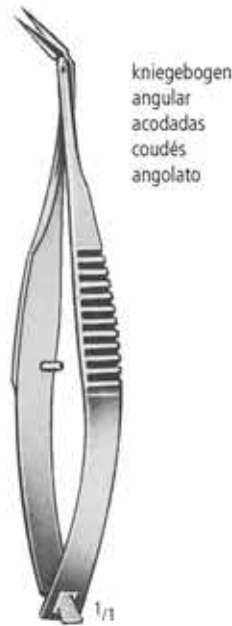

kniegebogen
 angular
 acodadas
 coudés
 angolato

AC 776/03
 8,5 cm/3 1/3"

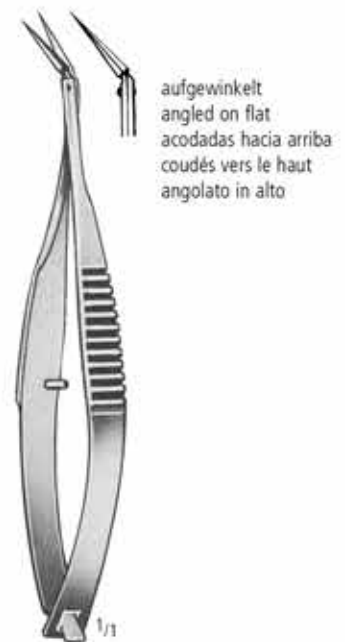

aufgewinkelt
 angled on flat
 acodadas hacia arriba
 coudés vers le haut
 angolato in alto

AC 776/04
 8,5 cm/3 1/3"

VANNAS MOD. TÜBINGEN



gerade
 straight
 rectas
 droits
 rette

VANNAS
AC 778/01
 8,0 cm/3"



gebogen
 curved
 curvas
 courbes
 curve

VANNAS
AC 778/02
 8,0 cm/3"

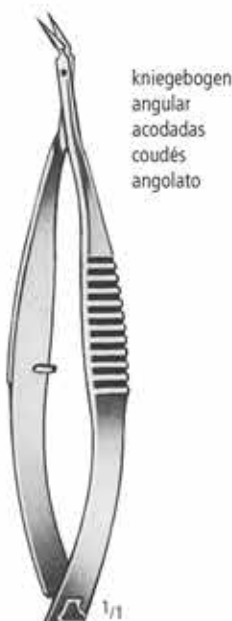

kniegebogen
 angular
 acodadas
 coudés
 angolato

VANNAS
AC 778/03
 8,0 cm/3"

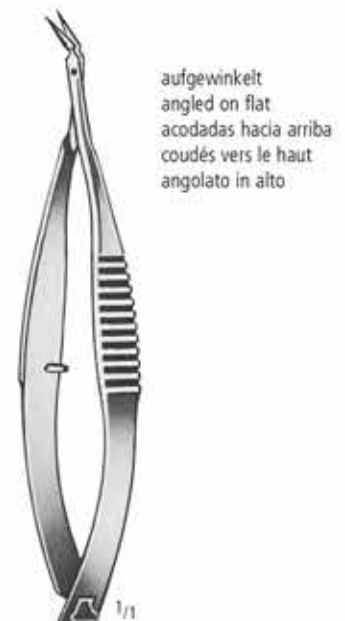

aufgewinkelt
 angled on flat
 acodadas hacia arriba
 coudés vers le haut
 angolato in alto

VANNAS
AC 778/04
 8,0 cm/3"

AA
 AB
 AC
 AD
 AE
 AF
 AG
 AH
 AI
 AJ
 AK
 AL
 AM
 AN
 AO
 AP
 AQ
 AR
 AS
 AT
 AU
 AV
 AW
 AX
 AY
 AZ

AC SCHEREN SCISSORS TIJERAS CISEAUX FORBICI

Sehnenscheren, Kapsulotomiescheren
 Tenotomy Scissors, Capsulotomy Scissors
 Tijeras para tenotomía, Tijeras para capsulotomía
 Ciseaux à ténatomie, Ciseaux pour capsulotomie
 Forbici per tenotomia, Forbici per capsulotomia



GILLS-WELSH
 8,5 cm/3¹/₃"



AC 779/01



AC 779/02



AC 779/03

kniegebogen
 angular
 acodadas
 coudés
 angolato



AC 779/04

aufgewinkelt
 angled on flat
 acodadas hacia arriba
 coudés vers le haut
 angolato in alto



WESTCOTT
AC 780/11
 11,0 cm/4¹/₃"



WESTCOTT
AC 782/11
 11,0 cm/4¹/₃"

SCHEREN SCISSORS TIJERAS CISEAUX FORBICI

Hornhautscheren
 Corneal Section Scissors
 Pinzas-tijeras para córnea
 Pincis ciseaux corneales
 Forbici per cornea



CASTROVIEJO
AC 785/01
 10,0 cm/4"



CASTROVIEJO
AC 785/02
 10,0 cm/4"

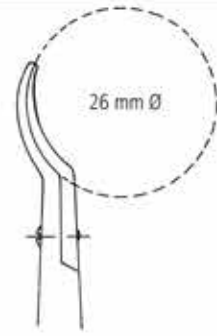

CASTROVIEJO
AC 786/01
 11,0 cm/4 1/3"



CASTROVIEJO
AC 786/02
 11,0 cm/4 1/3"



TROUTMAN
AC 788/01
 10,0 cm/4"



TROUTMAN
AC 788/02
 10,0 cm/4"

AA
 AB
AC
 AD
 AE
 AF
 AG
 AH
 AI
 AJ
 AK
 AL
 AM
 AN
 AO
 AP
 AQ
 AR
 AS
 AT
 AU
 AV
 AW
 AX
 AY
 AZ

AC SCHEREN SCISSORS TIJERAS CISEAUX FORBICI

Hornhautscheren
 Corneal Section Scissors
 Pinzas-tijeras para córnea
 Pincis ciseaux corneales
 Forbici per cornea



KATZIN
AC 790/01
 10,0 cm/4"



KATZIN
AC 790/02
 10,0 cm/4"



KATZIN
AC 791/01
 11,0 cm/4¹/₃"



KATZIN
AC 791/02
 11,0 cm/4¹/₃"

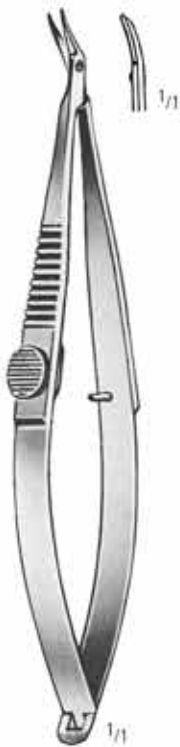

KATZIN-BARRAQUER
AC 792/01
 10,0 cm/4"

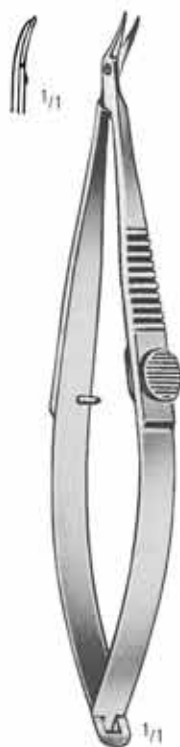

KATZIN-BARRAQUER
AC 792/02
 10,0 cm/4"



KATZIN-BARRAQUER
AC 793/00
 10,0 cm/4"



KATZIN-BARRAQUER
AC 793/01
 10,0 cm/4"

SCHEREN SCISSORS TIJERAS CISEAUX FORBICI

Hornhautscheren, Mikroscheren
 Corneal Section Scissors, Micro Scissors
 Pinzas-tijeras para córnea, Micro Tijeras
 Pincés ciseaux corneales, Micro-ciseaux
 Forbici per cornea, Micro forbici

AA
 AB
 AC
 AD
 AE
 AF
 AG
 AH
 AI
 AJ
 AK
 AL
 AM
 AN
 AO
 AP
 AQ
 AR
 AS
 AT
 AU
 AV
 AW
 AX
 AY
 AZ



AC 794/12
 12,0 cm/4³/₄"



WESTCOTT
AC 797/01
 11,5 cm/4¹/₂"



WESTCOTT
AC 797/02
 11,5 cm/4¹/₂"

AC SCHEREN SCISSORS TIJERAS CISEAUX FORBICI

Mikroscheren
Micro Scissors
Micro Tijeras
Micro Ciseaux
Micro Forbici

- >> Alle unsere Mikroscheren werden von Fachkräften mit jahrelanger Erfahrung hergestellt. Die Endkontrolle findet unter dem Mikroskop statt. Um Ihnen ein ermüdungsfreies Arbeiten zu ermöglichen, wird dem Federdruck größte Aufmerksamkeit gewidmet.
- >> Bitte wählen Sie unter Rund- oder Flachgriffscheren.

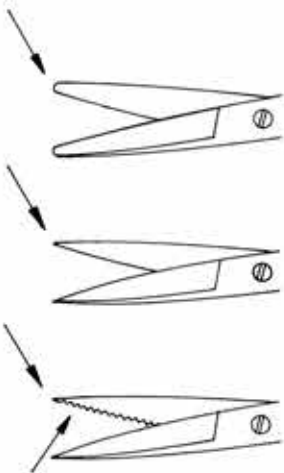

Dissection: **Gebogene Blätter, abgerundete Spitzen** ermöglichen eine gute und sichere Dissektion, ohne Nerven und Blutgefäße zu beschädigen.

Adventitia: **Gerade Blätter, sehr scharfe Spitzen** gewährleisten präzises Anfrischen von Gefäßenden.

Nerve: Ein Blatt ist **fein gezahnt**, um ein Herausgleiten des Nervs zu vermeiden.

- >> All our Micro Scissors are manufactured by skilled craftsmen with many years of experience. Final inspection is carried out under a microscope. Careful attention is paid to the closing pressure of the spring handle, to ensure precise work during surgeries, without fatigue.
- >> Round or flat handle scissors according to your preference.

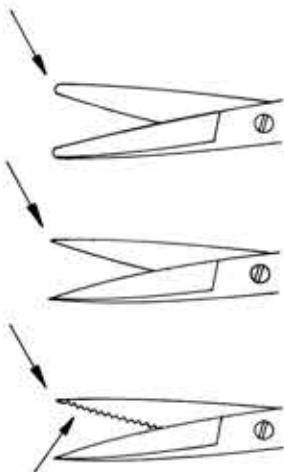

Dissection: **Curved blades, slightly rounded tips** ensure safe dissection without damage to nerves and vessels.

Adventitia: **Straight blades, very sharp tips** for finest trimming of vessel ends.

Nerve: One blade is **fine-toothed** to avoid slipping of the nerve.

SCHEREN SCISSORS TIJERAS CISEAUX FORBICI

Mikroscheren
Micro Scissors
Micro Tijeras
Micro Ciseaux
Micro Forbici

AA

AB

AC

AD

AE

AF

AK

AL

AM

AO

AP

AR

KA

KD

KU

KV



**Dissection
AC 801/15**



**Adventitia
AC 803/15**

14,5 cm/5³/₄"



**Dissection
AC 801/18**

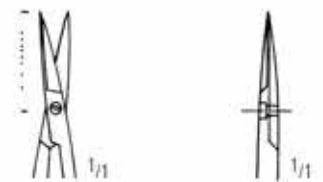

**Adventitia
AC 803/18**

18,0 cm/7"

AC SCHEREN SCISSORS TIJERAS CISEAUX FORBICI

Mikroscheren
Micro Scissors
Micro Tijeras
Micro Ciseaux
Micro Forbici

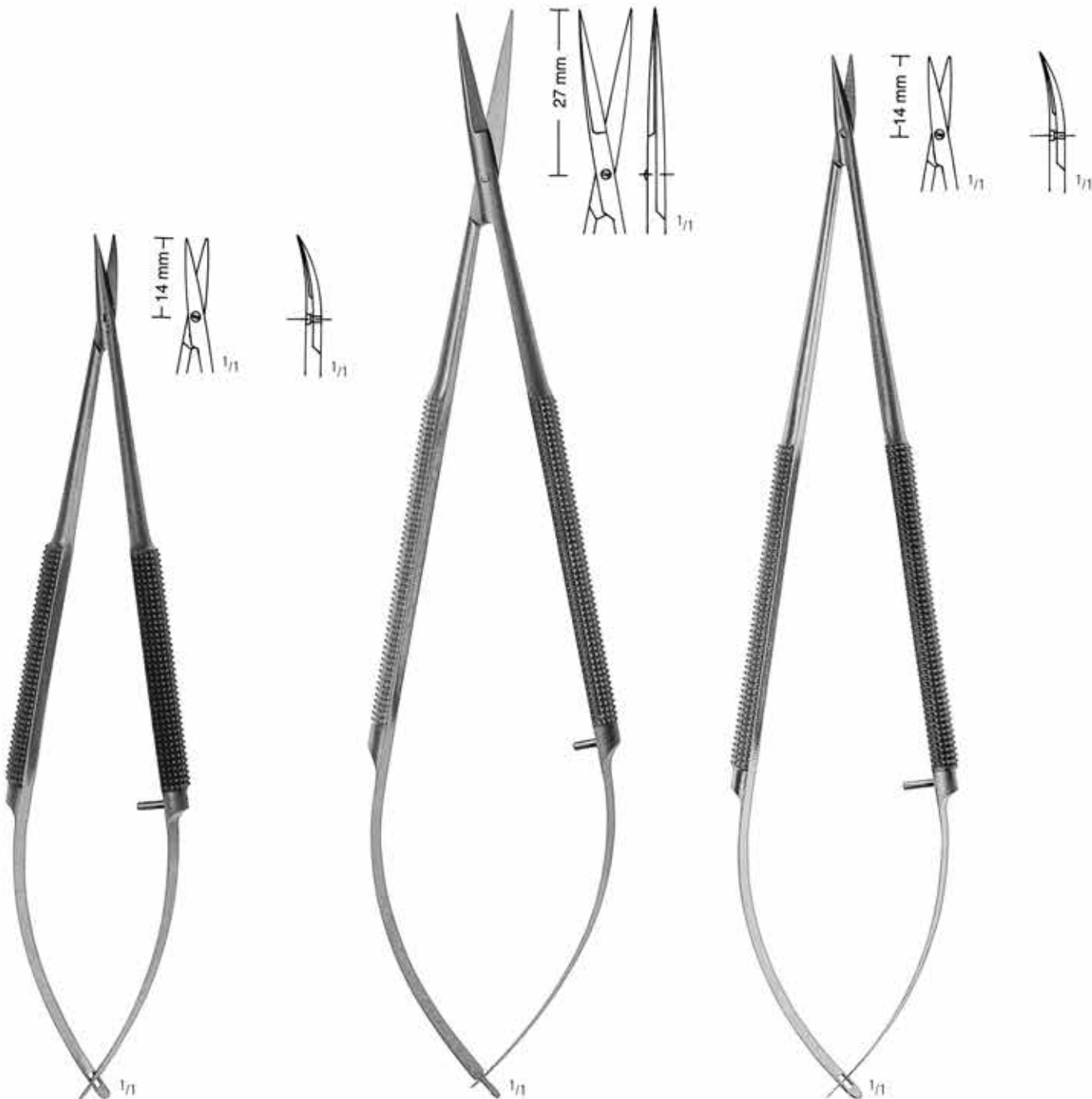

AC 807/14
14,5 cm/5³/₄"

AC 812/18
18,0 cm/7"

AC 817/18
18,0 cm/7"

SCHEREN SCISSORS TIJERAS CISEAUX FORBICI

Mikroschere
Micro Scissors
Micro Tijeras
Micro Ciseaux
Micro Forbici

AA

AB

AC

AD

AE

AF

AK

AL

AM

AO

AP

AR

KA

KD

KU

KV



11,0 cm/4 1/3"

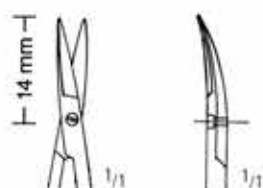

Dissection
AC 821/11

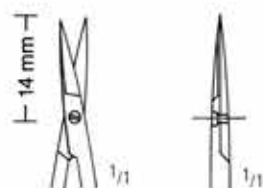

Adventitia
AC 830/11



15,0 cm/6"



Dissection
AC 823/15

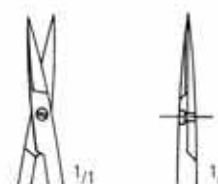

Adventitia
AC 832/15

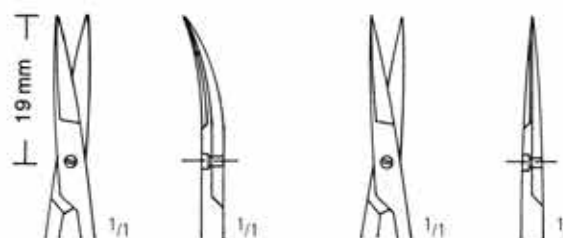

Dissection
AC 825/15

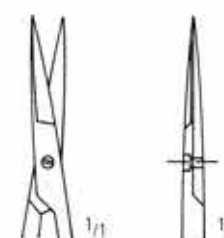

Adventitia
AC 834/15

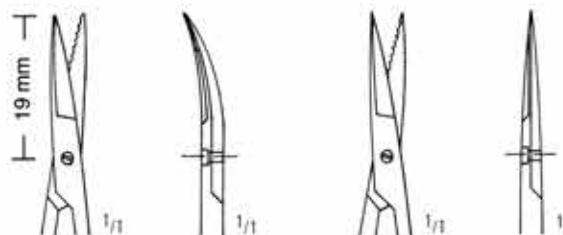

Dissection >> Nerve >> Adventitia
AC 827/15 AC 836/15

AC SCHEREN SCISSORS TIJERAS CISEAUX FORBICI

Mikroscheren
Micro Scissors
Micro Tijeras
Micro Ciseaux
Micro Forbici



18,5 cm/7¹/₂"



AC 850/19



AC 851/19



16,0 cm/6¹/₄"
19,0 cm/7¹/₂"
22,5 cm/9"



AC 860/16
AC 860/20
AC 860/22



AC 861/16
AC 861/20
AC 861/22



AC 862/16
AC 862/20
AC 862/22



AC 863/16
AC 863/20
AC 863/22



AC 864/16
AC 864/20
AC 864/22



AC 865/16
AC 865/20
AC 865/22

SCHEREN SCISSORS TIJERAS CISEAUX FORBICI

Mikroscheren
Micro Scissors
Micro Tijeras
Micro Ciseaux
Micro Forbici



18,0 cm/7"



AC 870/01
25°



AC 870/02
45°



AC 870/03
60°



AC 870/04
90°



AC 870/05
125°



18,0 cm/7"



AC 871/01
25°



AC 871/02
45°



AC 871/03
60°



AC 871/04
90°



AC 871/05
125°

AA
AB
AC
AD
AE
AF
AG
AH
AI
AJ
AK
AL
AM
AN
AO
AP
AQ
AR
AS
AT
AU
AV
AW
AX
AY
AZ
BA
BB
BC
BD
BE
BF
BG
BH
BI
BJ
BK
BL
BM
BN
BO
BP
BQ
BR
BS
BT
BU
BV
BW
BX
BY
BZ
CA
CB
CC
CD
CE
CF
CG
CH
CI
CJ
CK
CL
CM
CN
CO
CP
CQ
CR
CS
CT
CU
CV
CW
CX
CY
CZ
DA
DB
DC
DD
DE
DF
DG
DH
DI
DJ
DK
DL
DM
DN
DO
DP
DQ
DR
DS
DT
DU
DV
DW
DX
DY
DZ
EA
EB
EC
ED
EE
EF
EG
EH
EI
EJ
EK
EL
EM
EN
EO
EP
EQ
ER
ES
ET
EU
EV
EW
EX
EY
EZ
FA
FB
FC
FD
FE
FF
FG
FH
FI
FJ
FK
FL
FM
FN
FO
FP
FQ
FR
FS
FT
FU
FV
FW
FX
FY
FZ
GA
GB
GC
GD
GE
GF
GG
GH
GI
GJ
GK
GL
GM
GN
GO
GP
GQ
GR
GS
GT
GU
GV
GW
GX
GY
GZ
HA
HB
HC
HD
HE
HF
HG
HH
HI
HJ
HK
HL
HM
HN
HO
HP
HQ
HR
HS
HT
HU
HV
HW
HX
HY
HZ
IA
IB
IC
ID
IE
IF
IG
IH
II
IJ
IK
IL
IM
IN
IO
IP
IQ
IR
IS
IT
IU
IV
IW
IX
IY
IZ
JA
JB
JC
JD
JE
JF
JG
JH
JI
JJ
JK
JL
JM
JN
JO
JP
JQ
JR
JS
JT
JU
JV
JW
JX
JY
JZ
KA
KB
KC
KD
KE
KF
KG
KH
KI
KJ
KK
KL
KM
KN
KO
KP
KQ
KR
KS
KT
KU
KV
KW
KX
KY
KZ
LA
LB
LC
LD
LE
LF
LG
LH
LI
LJ
LK
LL
LM
LN
LO
LP
LQ
LR
LS
LT
LU
LV
LW
LX
LY
LZ
MA
MB
MC
MD
ME
MF
MG
MH
MI
MJ
MK
ML
MM
MN
MO
MP
MQ
MR
MS
MT
MU
MV
MW
MX
MY
MZ
NA
NB
NC
ND
NE
NF
NG
NH
NI
NJ
NK
NL
NM
NN
NO
NP
NQ
NR
NS
NT
NU
NV
NW
NX
NY
NZ
OA
OB
OC
OD
OE
OF
OG
OH
OI
OJ
OK
OL
OM
ON
OO
OP
OQ
OR
OS
OT
OU
OV
OW
OX
OY
OZ
PA
PB
PC
PD
PE
PF
PG
PH
PI
PJ
PK
PL
PM
PN
PO
PP
PQ
PR
PS
PT
PU
PV
PW
PX
PY
PZ
QA
QB
QC
QD
QE
QF
QG
QH
QI
QJ
QK
QL
QM
QN
QO
QP
QQ
QR
QS
QT
QU
QV
QW
QX
QY
QZ
RA
RB
RC
RD
RE
RF
RG
RH
RI
RJ
RK
RL
RM
RN
RO
RP
RQ
RR
RS
RT
RU
RV
RW
RX
RY
RZ
SA
SB
SC
SD
SE
SF
SG
SH
SI
SJ
SK
SL
SM
SN
SO
SP
SQ
SR
SS
ST
SU
SV
SW
SX
SY
SZ
TA
TB
TC
TD
TE
TF
TG
TH
TI
TJ
TK
TL
TM
TN
TO
TP
TQ
TR
TS
TT
TU
TV
TW
TX
TY
TZ
UA
UB
UC
UD
UE
UF
UG
UH
UI
UJ
UK
UL
UM
UN
UO
UP
UQ
UR
US
UT
UU
UV
UW
UX
UY
UZ
VA
VB
VC
VD
VE
VF
VG
VH
VI
VJ
VK
VL
VM
VN
VO
VP
VQ
VR
VS
VT
VU
VV
VW
VX
VY
VZ
WA
WB
WC
WD
WE
WF
WG
WH
WI
WJ
WK
WL
WM
WN
WO
WP
WQ
WR
WS
WT
WU
WV
WW
WX
WY
WZ
XA
XB
XC
XD
XE
XF
XG
XH
XI
XJ
XK
XL
XM
XN
XO
XP
XQ
XR
XS
XT
XU
XV
XW
XX
XY
XZ
YA
YB
YC
YD
YE
YF
YG
YH
YI
YJ
YK
YL
YM
YN
YO
YP
YQ
YR
YS
YT
YU
YV
YW
YX
YY
YZ
ZA
ZB
ZC
ZD
ZE
ZF
ZG
ZH
ZI
ZJ
ZK
ZL
ZM
ZN
ZO
ZP
ZQ
ZR
ZS
ZT
ZU
ZV
ZW
ZX
ZY
ZZ



nopa® TUC

SC Super Cut

SUPER CUT TUC



SUPER CUT TUC

Besonderheit:

Nutzen Sie die Vorteile von Hartmetalleinsätzen.

nopa TUC Super Cut Scheren haben eine rasierklingscharfe Schneide, kombiniert mit einer mikrogezahnten Schneide.

>> Diese Scheren sind durch schwarz/goldene Ringe gekennzeichnet.

Features:

Use the advantages of Tungsten Carbide.

nopa TUC Super Cut scissors have a razor-like edge combined with one micro serrated blade.

>> Black/golden rings for easy identification.

Verfügbare Modelle / Available Patterns

Im Katalog durch * markiert. / Marked in catalog with *.

AC 902/14 SC STANDARD SCS. TUC STR. SH/BL 14.5 CM SC
AC 903/14 SC STANDARD SCS. TUC CVD. SH/BL 14.5 CM SC
AC 910/14 SC MAYO DISS. SCS. TUC STR. BL/BL 14.5 CM SC
AC 910/17 SC MAYO DISS. SCS. TUC STR. BL/BL 17.0 CM SC
AC 911/14 SC MAYO DISS. SCS. TUC CVD. BL/BL 14.5 CM SC
AC 911/17 SC MAYO DISS. SCS. TUC CVD. BL/BL 17.0 CM SC
AC 916/15 SC MAYO-STILLE SCS. TUC STR. BL/BL 15.0 CM SC
AC 916/17 SC MAYO-STILLE SCS. TUC STR. BL/BL 17.0 CM SC
AC 917/15 SC MAYO-STILLE SCS. TUC CVD. BL/BL 15.0 CM SC
AC 917/17 SC MAYO-STILLE SCS. TUC CVD. BL/BL 17.0 CM SC
AC 930/14 SC METZENBAUM SCS. TUC STR. BL/BL 14.5 CM SC
AC 931/14 SC METZENBAUM SCS. TUC CVD. BL/BL 14.5 CM SC
AC 940/18 SC METZENBAUM SCS. TUC STR. BL/BL 18.0 CM SC
AC 940/20 SC METZENBAUM SCS. TUC STR. BL/BL 20.0 CM SC
AC 941/18 SC METZENBAUM SCS. TUC CVD. BL/BL 18.0 CM SC
AC 941/20 SC METZENBAUM SCS. TUC CVD. BL/BL 20.0 CM SC
AC 941/23 SC METZENBAUM SCS. TUC CVD. BL/BL 23.0 CM SC
AC 941/25 SC METZENBAUM SCS. TUC CVD. BL/BL 25.0 CM SC
AC 960/14 SC METZENBAUM-DEL. SCS. TUC STR. BL/BL 14.5 CM SC
AC 961/14 SC METZENBAUM-DEL. SCS. TUC CVD. BL/BL 14.5 CM SC
AC 970/18 SC METZENBAUM-DEL. SCS. TUC STR. BL/BL 18.0 CM SC
AC 970/20 SC METZENBAUM-DEL. SCS. TUC STR. BL/BL 20.0 CM SC
AC 971/18 SC METZENBAUM-DEL. SCS. TUC CVD. BL/BL 18.0 CM SC
AC 971/20 SC METZENBAUM-DEL. SCS. TUC CVD. BL/BL 20.0 CM SC
AC 974/11 SC STEVENS TENO. SCS. STR. POINTED. 11.5 CM SC
AC 975/11 SC STEVENS TENO. SCS. CVD. POINTED. 11.5 CM SC
AC 984/11 SC IRIS SCS. TUC STR. SH/SH 11.5 CM SC
AC 985/11 SC IRIS SCS. TUC CVD. SH/SH 11.5 CM SC

AA

AB

AC

AD

AE

AF

AK

AL

AM

AO

AP

AR

KA

KD

KU

KY

AC SCHEREN SCISSORS TIJERAS CISEAUX FORBICI

Scheren mit Hartmetalleinlagen
 Scissors with Tungsten Carbide Inserts
 Tijeras con filos de carburo de tungsteno
 Ciseaux avec plaquettes en carbure de tungstène
 Forbici con taglio al carburo di tungsteno

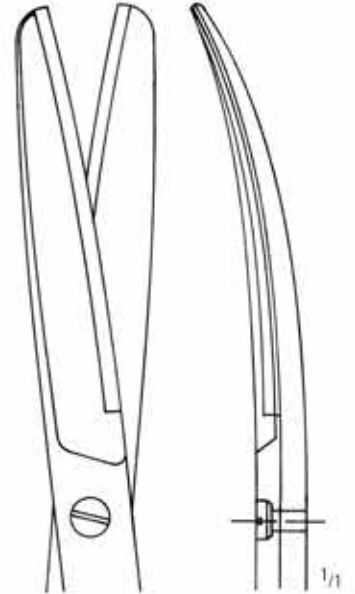
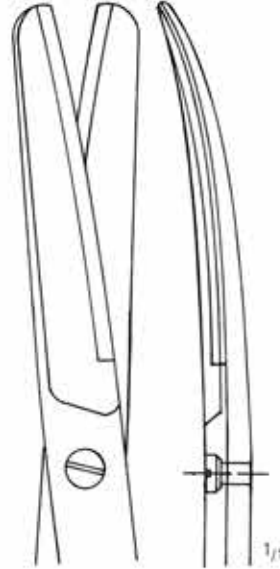
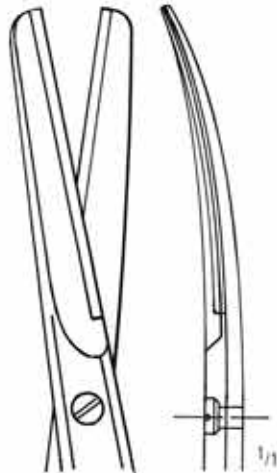

STANDARD
 Fig. 1

straight: 14,5 cm/5³/₄"
AC 900/14
 curved: **AC 901/14**

16,5 cm/6¹/₂"
AC 900/16
AC 901/16

18,5 cm/7¹/₃"
AC 900/18
AC 901/18

nopa®
TUC

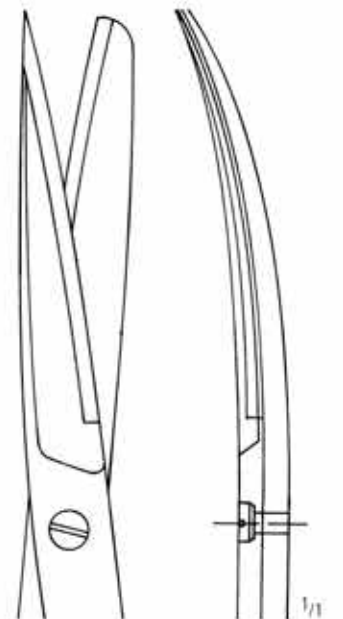
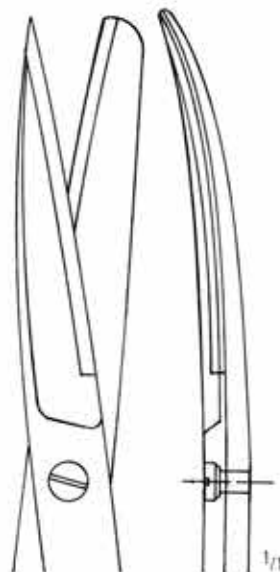
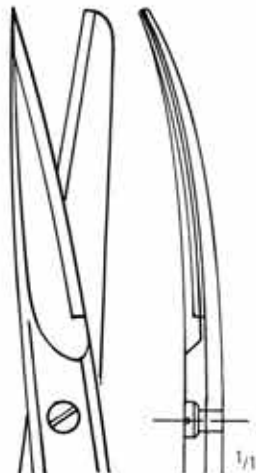

STANDARD
 Fig. 2

straight: 14,5 cm/5³/₄"
AC 902/14*
 curved: **AC 903/14***

16,5 cm/6¹/₂"
AC 902/16
AC 903/16

18,5 cm/7¹/₃"
AC 902/18
AC 903/18

SCHEREN SCISSORS TIJERAS CISEAUX FORBICI

Scheren mit Hartmetalleinlagen
 Scissors with Tungsten Carbide Inserts
 Tijeras con filos de carburo de tungsteno
 Ciseaux avec plaquettes en carbure de tungstène
 Forbici con taglio al carburo di tungsteno

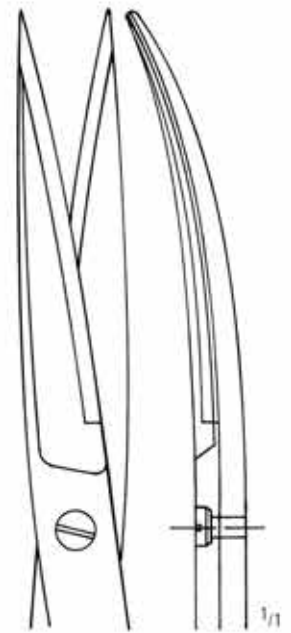
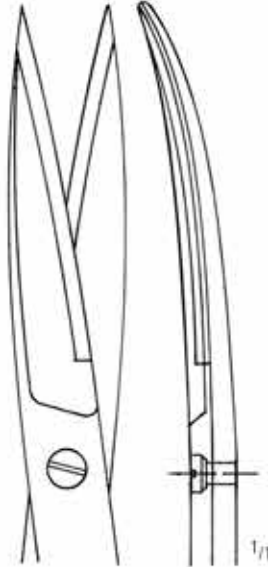
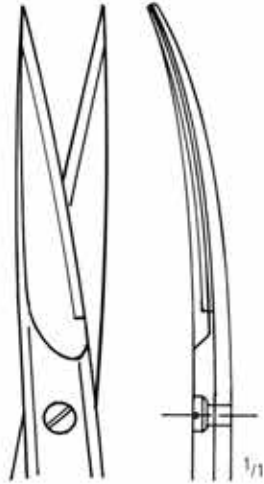

STANDARD
 Fig. 3

straight: 14,5 cm/5³/₄"
AC 904/14
 curved: **AC 905/14**

16,5 cm/6¹/₂"
AC 904/16
AC 905/16

18,5 cm/7¹/₃"
AC 904/18
AC 905/18

nopa[®]
TUC

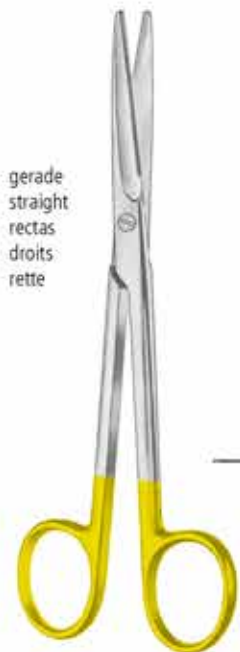

gerade
 straight
 rectas
 droits
 rette

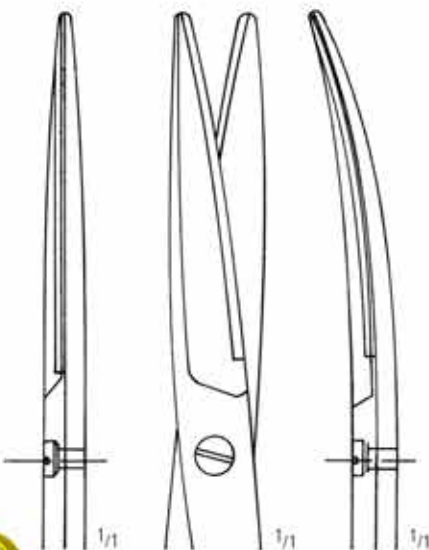

Original 17,0 cm

MAYO
AC 910/14*
AC 910/17*
AC 910/23

14,5 cm/5¹/₂"
 17,0 cm/6³/₄"
 23,0 cm/9"

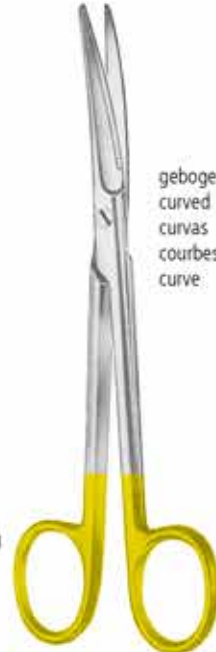

gebogen
 curved
 curvas
 courbes
 curve

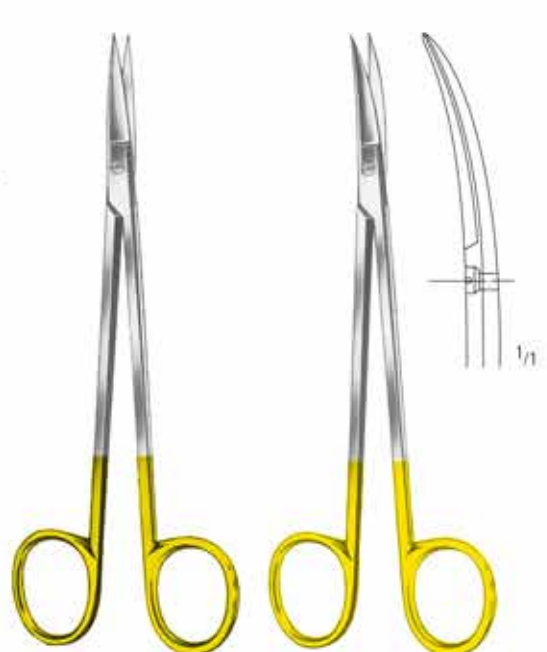

MAYO
AC 911/14*
AC 911/17*
AC 911/23

AC 912/16 **KELLY** 16,0 cm/6¹/₄" **AC 913/16**

* Auch erhältlich als SC * Also available as SC

AA
 AB
 AC
 AD
 AE
 AF
 AG
 AH
 AI
 AJ
 AK
 AL
 AM
 AN
 AO
 AP
 AQ
 AR
 AS
 AT
 AU
 AV
 AW
 AX
 AY
 AZ

AC SCHEREN SCISSORS TIJERAS CISEAUX FORBICI

Scheren mit Hartmetalleinlagen
 Scissors with Tungsten Carbide Inserts
 Tijeras con filos de carburo de tungsteno
 Ciseaux avec plaquettes en carbure de tungstène
 Forbici con taglio al carburo di tungsteno



PARAMETRIUM

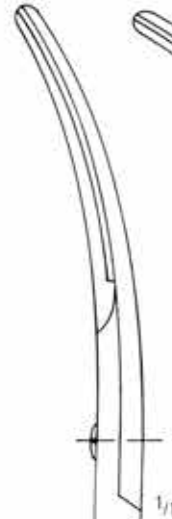

AC 915/01
22,5 cm/9"

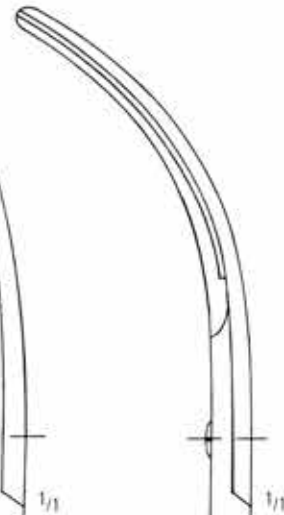

AC 915/02
23,0 cm/9"

nopa[®]
TUC



MAYO-STILLE
AC 916/15*
AC 916/17*



Original 17,0 cm



15,0 cm/6"
17,0 cm/6³/₄"



MAYO-STILLE
AC 917/15*
AC 917/17*

SCHEREN SCISSORS TIJERAS CISEAUX FORBICI

Scheren mit Hartmetalleinlagen
 Scissors with Tungsten Carbide Inserts
 Tijeras con filos de carburo de tungsteno
 Ciseaux avec plaquettes en carbure de tungstène
 Forbici con taglio al carburo di tungsteno

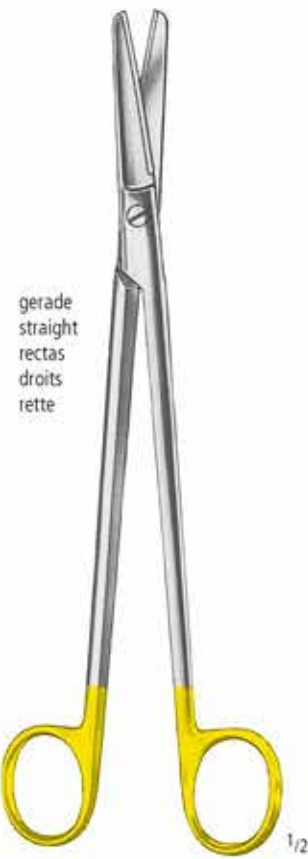

gerade
straight
rectas
droits
rette

SIMS
AC 918/23
 23,0 cm/9"

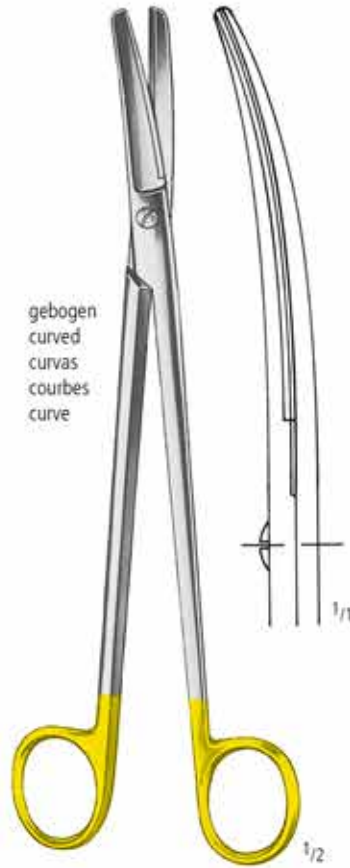

gebogen
curved
curvas
courbes
curve

SIMS
 20,0 cm/8" **AC 919/20**
 23,0 cm/9" **AC 919/23**



AC 920/20
 20,0 cm/8"

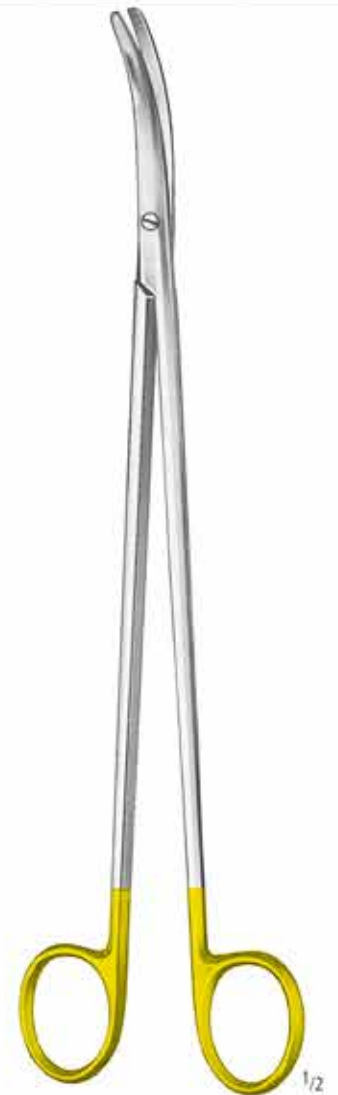

CARDINALE
AC 921/28
 28,0 cm/11"

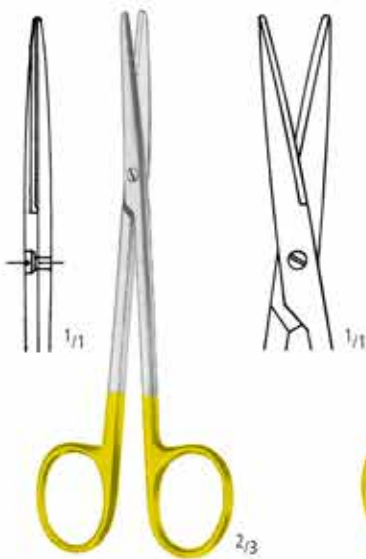

AC 922/11
 11,5 cm/4 1/2"



METZENBAUM
AC 923/11
 11,5 cm/4 1/2"



AC 930/14*
 14,5 cm/5 3/4"

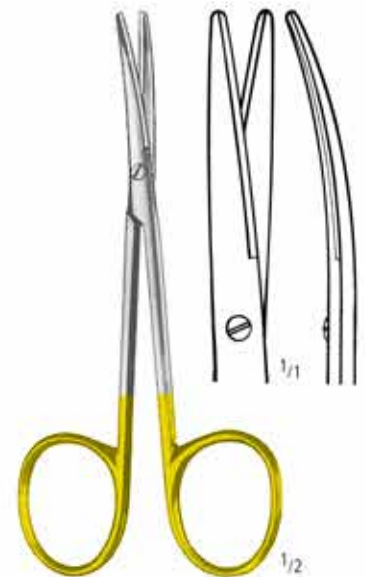

METZENBAUM
AC 931/14*
 14,5 cm/5 3/4"

* Auch erhältlich als SC * Also available as SC

AA
 AB
 AC
 AD
 AE
 AF
 AG
 AH
 AI
 AJ
 AK
 AL
 AM
 AN
 AO
 AP
 AQ
 AR
 AS
 AT
 AU
 AV
 AW
 AX
 AY
 AZ

AC SCHEREN SCISSORS TIJERAS CISEAUX FORBICI

Scheren mit Hartmetalleinlagen
 Scissors with Tungsten Carbide Inserts
 Tijeras con filos de carburo de tungsteno
 Ciseaux avec plaquettes en carbure de tungstène
 Forbici con taglio al carburo di tungsteno

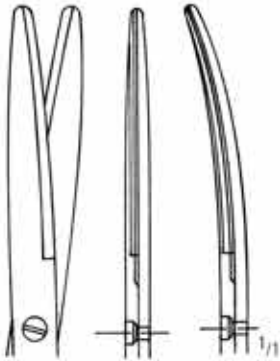

Original 18,0 cm

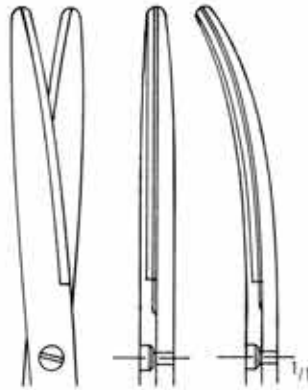

Original 20,0 cm

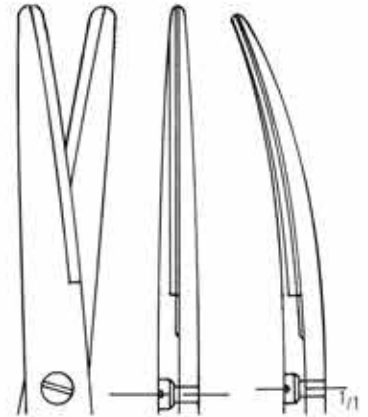

Original 23,0 cm



nopa®
TUC

gerade
 straight
 rectas
 droiti
 rette

gebogen
 curved
 curvas
 courbes
 curve

AC 940/18*	18,0 cm/7"	AC 941/18*
AC 940/20*	20,0 cm/8"	AC 941/20*
AC 940/23	23,0 cm/9"	AC 941/23*
AC 940/25	25,0 cm/10"	AC 941/25*
AC 940/28	28,0 cm/11"	AC 941/28
AC 940/30	30,0 cm/12"	AC 941/30
	36,0 cm/14"	AC 941/36

METZENBAUM

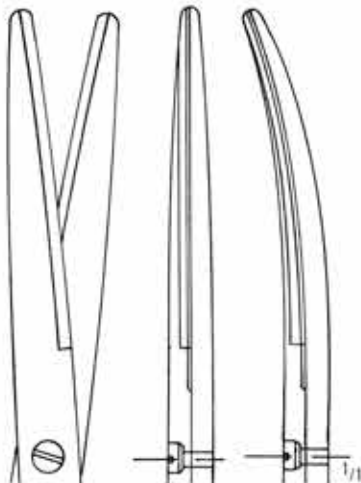

Original 25,0 cm

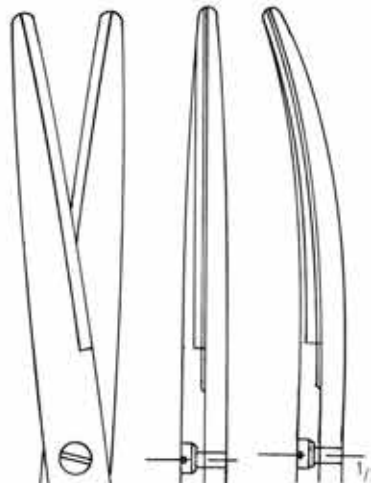

Original 28,0 cm

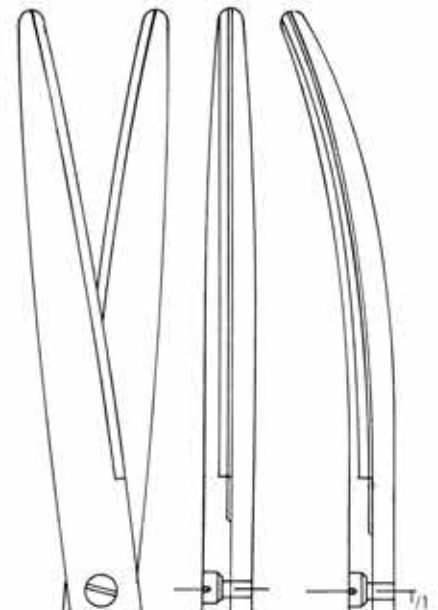

Original 30,0 cm

SCHEREN SCISSORS TIJERAS CISEAUX FORBICI

Scheren mit Hartmetalleinlagen
 Scissors with Tungsten Carbide Inserts
 Tijeras con filos de carburo de tungsteno
 Ciseaux avec plaquettes en carbure de tungstène
 Forbici con taglio al carburo di tungsteno

nopa[®]
TUC

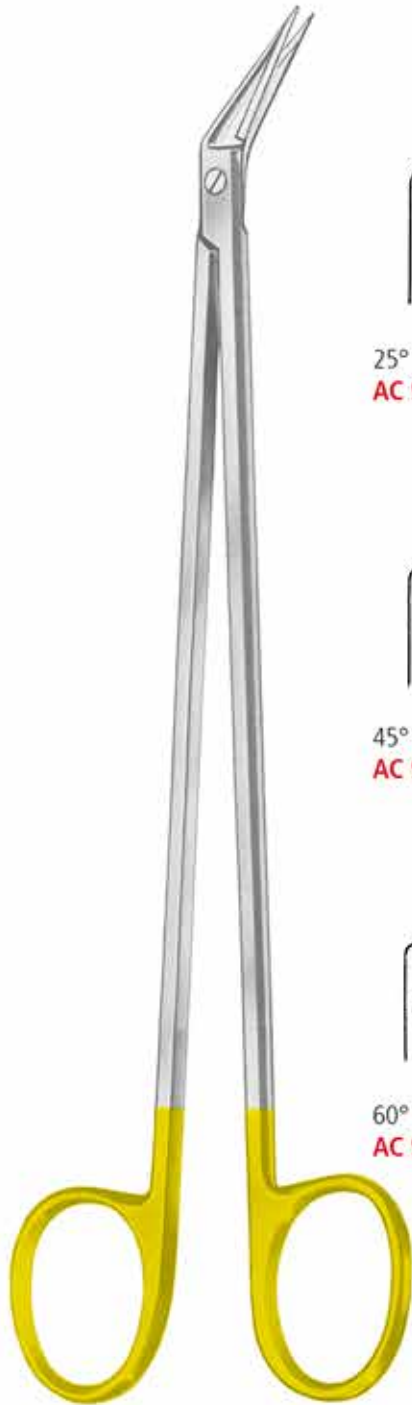

25°
 AC 948/25

45°
 AC 948/45

60°
 AC 948/60

POTTS-SMITH
 19,0 cm/7 1/2"



25°
 AC 949/25

45°
 AC 949/45

60°
 AC 949/60

DE BAKHEY
 18,0 cm/7"

AA
 AB
 AC
 AD
 AE
 AF
 AG
 AH
 AI
 AJ
 AK
 AL
 AM
 AN
 AO
 AP
 AQ
 AR
 AS
 AT
 AU
 AV
 AW
 AX
 AY
 AZ

AC SCHEREN SCISSORS TIJERAS CISEAUX FORBICI

Scheren mit Hartmetalleinlagen
 Scissors with Tungsten Carbide Inserts
 Tijeras con filos de carburo de tungsteno
 Ciseaux avec plaquettes en carbure de tungstène
 Forbici con taglio al carburo di tungsteno



LEXER
AC 952/16
 16,0 cm/6¹/₄"



LEXER
AC 953/16
 16,0 cm/6¹/₄"

nopa[®]
TUC



AC 960/14*
 14,5 cm/5³/₄"

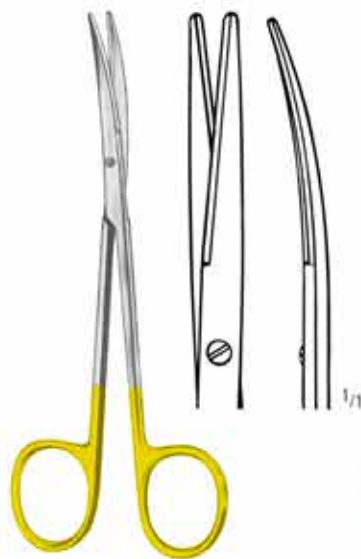

AC 961/14*
 14,5 cm/5³/₄"



METZENBAUM-DELICATE
AC 962/14
 14,5 cm/5³/₄"



AC 963/14
 14,5 cm /5³/₄"

SCHEREN SCISSORS TIJERAS CISEAUX FORBICI

Scheren mit Hartmetalleinlagen
 Scissors with Tungsten Carbide Inserts
 Tijeras con filos de carburo de tungsteno
 Ciseaux avec plaquettes en carbure de tungstène
 Forbici con taglio al carburo di tungsteno

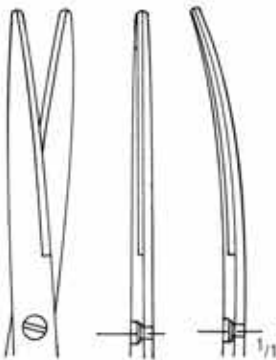

Original 18,0 cm

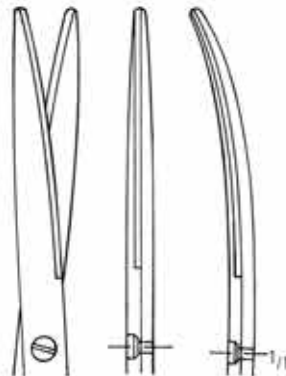

Original 20,0 cm

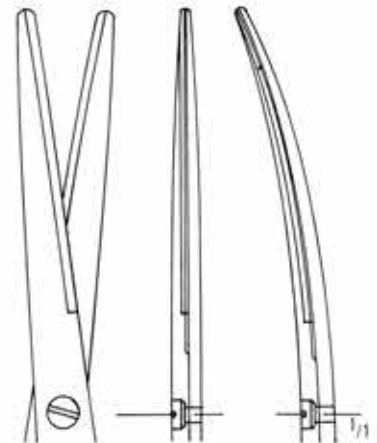

Original 23,0 cm



METZENBAUM-DELICATE

nopa®
TUC

gerade
 straight
 rectas
 droits
 rette

gebogen
 curved
 curvas
 courbes
 curve

AC 970/18*	18,0 cm/7"	AC 971/18*
AC 970/20*	20,0 cm/8"	AC 971/20*
AC 970/23	23,0 cm/9"	AC 971/23
AC 970/25	25,0 cm/10"	AC 971/25
AC 970/28	28,0 cm/11"	AC 971/28

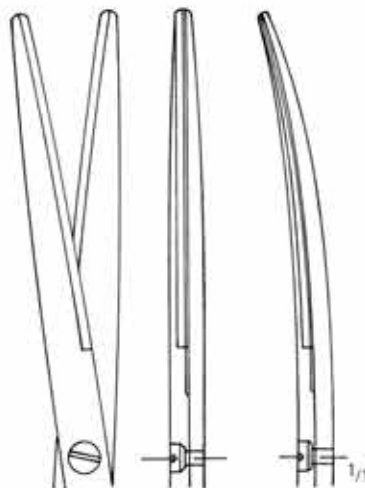

Original 25,0 cm

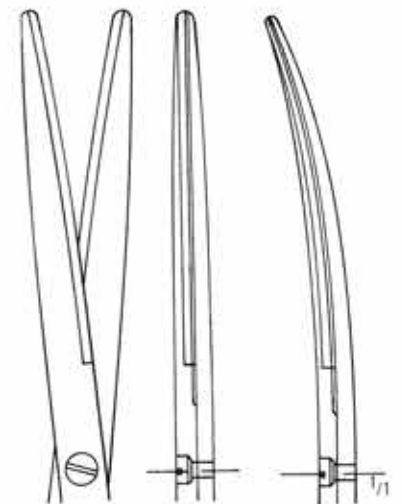

Original 28,0 cm

AA
 AB
AC
 AD
 AE
 AF
 AG
 AH
 AI
 AJ
 AK
 AL
 AM
 AN
 AO
 AP
 AQ
 AR
 AS
 AT
 AU
 AV
 AW
 AX
 AY
 AZ

AC SCHEREN SCISSORS TIJERAS CISEAUX FORBICI

Scheren mit Hartmetalleinlagen
 Scissors with Tungsten Carbide Inserts
 Tijeras con filos de carburo de tungsteno
 Ciseaux avec plaquettes en carbure de tungstène
 Forbici con taglio al carburo di tungsteno

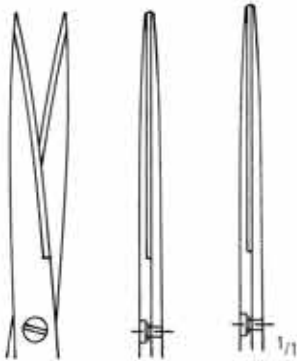

Original 18,0 cm

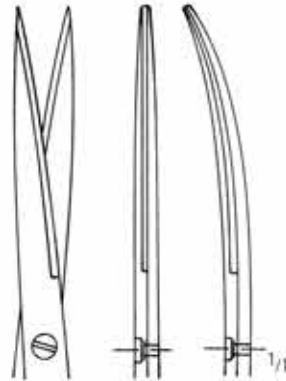

Original 20,0 cm

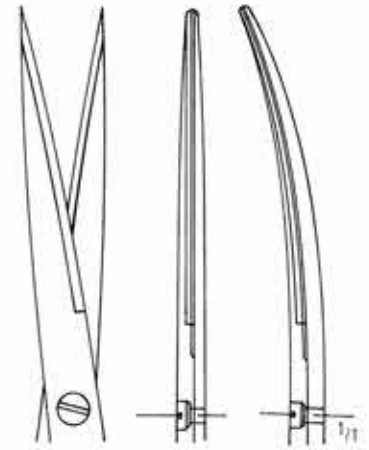

Original 23,0 cm



METZENBAUM-DELICATE

nopa®
TUC

gerade
 straight
 rectas
 droits
 rette

gebogen
 curved
 curvas
 courbes
 curve

AC 972/18	18,0 cm/7"	AC 973/18
AC 972/20	20,0 cm/8"	AC 973/20
AC 972/23	23,0 cm/9"	AC 973/23
AC 972/25	25,0 cm/10"	AC 973/25
AC 972/28	28,0 cm/11"	AC 973/28

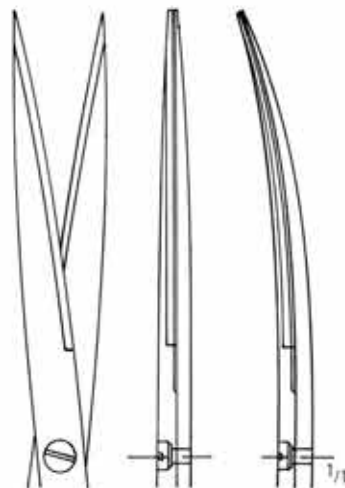

Original 25,0 cm

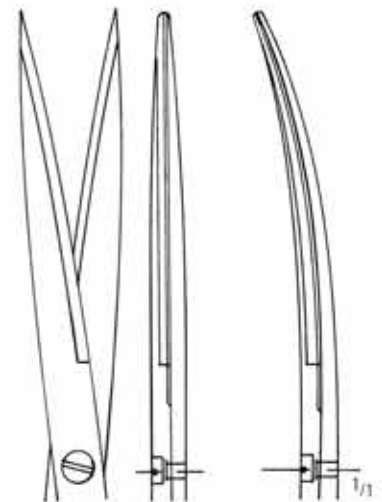

Original 28,0 cm

SCHEREN SCISSORS TIJERAS CISEAUX FORBICI

Scheren mit Hartmetalleinlagen
 Scissors with Tungsten Carbide Inserts
 Tijeras con filos de carburo de tungsteno
 Ciseaux avec plaquettes en carbure de tungstène
 Forbici con taglio al carburo di tungsteno



Original 11,5 cm

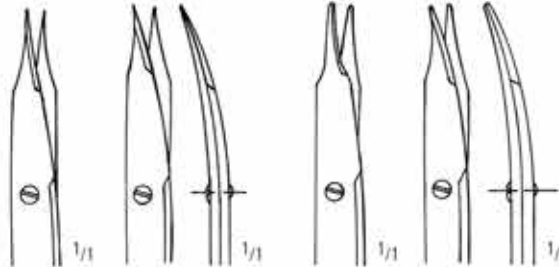

	spitz pointed agudas pointues acuta		stumpf blunt romas mousses smussa
gerade straight rectas droits rette	gebogen curved curvas courbes curve	gerade straight rectas droits rette	gebogen curved curvas courbes curve

STEVENS

10,5 cm/4¹/₄"
 11,5 cm/4¹/₂"

AC 974/10 AC 975/10 AC 976/10 AC 977/10
AC 974/11* AC 975/11* AC 976/11 AC 977/11

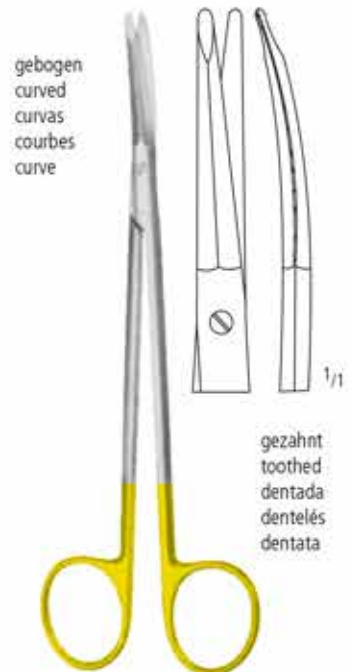
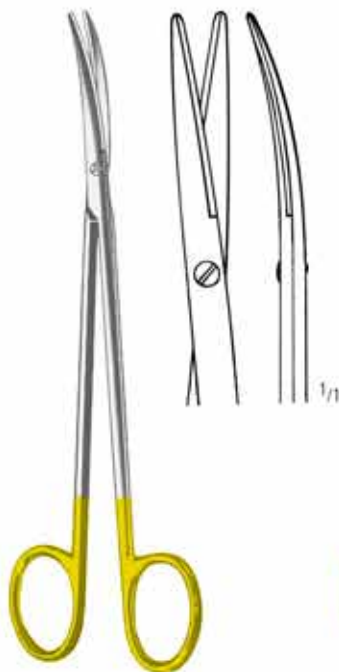

TOENNIS-ADSON-DELICATE

AC 977/17
 17,5 cm/7"

GOLDMAN-FOX

AC 980/13
 13,0 cm/5"

AC 981/13
 13,0 cm/5"

KAYE

AC 983/15
 15,0 cm/6"

gezahnt
toothed
dentada
dentelés
dentata

* Auch erhältlich als SC * Also available as SC

AA
AB
AC
AD
AE
AF
AG
AH
AI
AJ
AK
AL
AM
AN
AO
AP
AQ
AR
AS
AT
AU
AV
AW
AX
AY
AZ

AC SCHEREN SCISSORS TIJERAS CISEAUX FORBICI

Scheren mit Hartmetalleinlagen
 Scissors with Tungsten Carbide Inserts
 Tijeras con filos de carburo de tungsteno
 Ciseaux avec plaquettes en carbure de tungstène
 Forbici con taglio al carburo di tungsteno



AC 984/11*
 11,5 cm/4 1/2"



AC 985/11*
 11,5 cm/4 1/2"

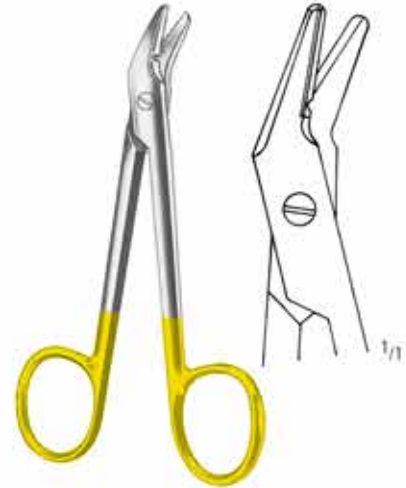

UNIVERSAL
 AC 987/12
 12,0 cm/4 3/4"

nopa[®]
TUC

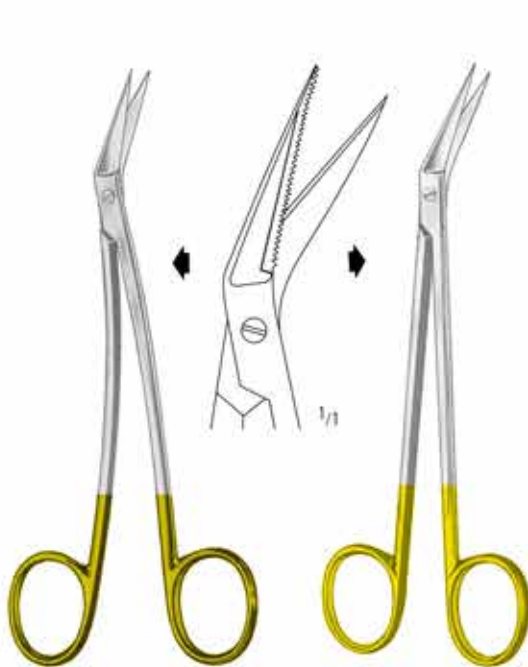

LOCKLIN
 AC 988/16
 16,5 cm/6 1/2"

LOCKLIN
 AC 989/16
 16,5 cm/6 1/2"

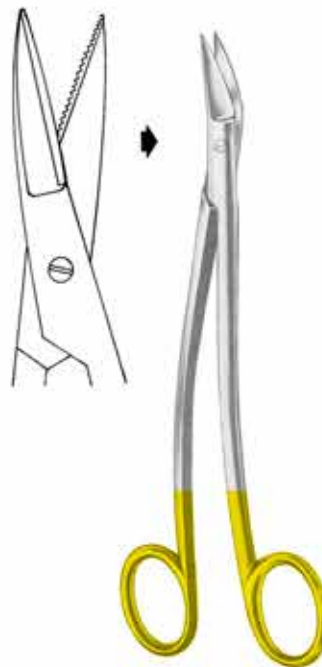

DEAN
 AC 990/17
 17,0 cm/6 3/4"



LISTER
 AC 999/18
 18,0 cm/7"

SKALPELLE
SCALPELS
BISTURIES
BISTOURIS
BISTURI

AD

nopa[®] instruments





nopa[®] instruments



SKALPELLE SCALPELS BISTURIES BISTOURIS BISTURI

Skalpellgriffe
 Scalpel Handles
 Mangos de bisturios
 Manches pour bistouris
 Manici per bisturi



AD 009/03
 No. 3



AD 010/03
 No. 3



AD 010/04
 No. 4



AD 010/05
 No. 5K



AD 020/13
 No. 3L



AD 020/14
 No. 4L



AD 020/15
 No. 5L

AA
 AB
 AC
AD
 AE
 AF
 AG
 AH
 AI
 AJ
 AK
 AL
 AM
 AN
 AO
 AP
 AQ
 AR
 AS
 AT
 AU
 AV
 AW
 AX
 AY
 AZ

AD SKALPELLE SCALPELS BISTURIES BISTOURIS BISTURI

Skalpellgriffe
 Scalpel Handles
 Mangos de bisturios
 Manches pour bistouris
 Manici per bisturi



AD 025/07
 No. 7



AD 027/07
 No. 7K



AD 030/16



AD 031/16
 No. 3



AD 031/21



COLLIN
AD 040/08
 No. 8



hohl
 hollow
 hueco
 creux
 vuoto

COLLIN
AD 042/09
 No. 9

Skalpellgriffe, Skalpellklingen
 Scalpel Handles, Scalpel Blades
 Mangos de bisturios, Hojas de bisturios
 Manches pour bistouris, Lames de bistouris
 Manici per bisturi, Lame per bisturi

MINI

Verpackungseinheit / packing unit = 10 St./pc.



Fig. 61
AD 065/61

Fig. 62
AD 065/62

Fig. 62S
AD 065/63

Fig. 64
AD 065/64

Fig. 65
AD 065/65

Fig. 67
AD 065/67

Fig. 69
AD 065/69



AD 065/10

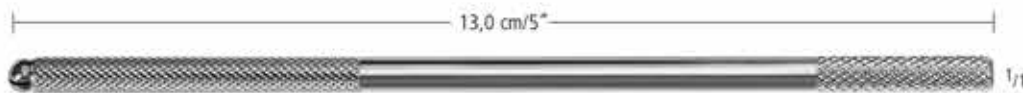

AD 065/13

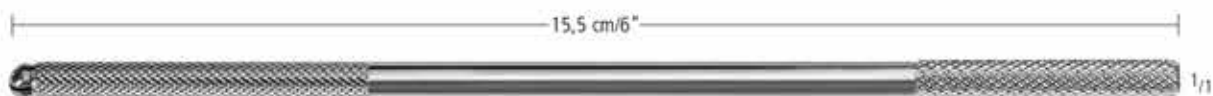

AD 065/15

AA
AB
AC
AD
AE
AF
AG
AH
AI
AJ
AK
AL
AM
AN
AO
AP
AQ
AR
AS
AT
AU
AV
AW
AX
AY
AZ

AD SKALPELLE SCALPELS BISTURIES BISTOURIS BISTURI

Skalpellklingen
Scalpel Blades
Hojas de bisturias
Lames pour bistouris
Lame per bisturi

passend für die Griffe
for handles
para los mangos
pour les manches
per i manici

- AD 009/03**
- AD 010/03**
- AD 020/13**
- AD 025/07**
- AD 027/07**
- AD 030/16**
- AD 040/08**



Fig.10
AD 075/10



Fig.11
AD 075/11



Fig.12d
AD 076/12



Fig.15
AD 075/15



Fig.15c
AD 076/15



passend für die Griffe
for handles
para los mangos
pour les manches
per i manici

- AD 010/04**
- AD 020/14**
- AD 042/09**



Fig.20
AD 075/20



Fig.21
AD 075/21



Fig.22
AD 075/22



Fig.23
AD 075/23



Fig.24
AD 075/24



AD 080/01

SKALPELLE SCALPELS BISTURIES BISTOURIS BISTURI

Operations-Skalpelle
 Operating Knives
 Bisturías para operaciones
 Bistouris pour opérations
 Bisturi per interventi

AA
 AB
 AC
AD
 AE
 AF
 AK
 AL
 AM
 AO
 AP
 AR
 KA
 KD
 KU
 KY



14,5 cm/5³/₄"



Fig.1
AD 200/01



Fig.3
AD 200/03



Fig.5
AD 200/05



Fig.7
AD 200/07



Fig.9
AD 200/09



Fig.10
AD 200/10



Fig.12
AD 200/12



Fig.14
AD 200/14



Fig.16
AD 200/16



Fig.18
AD 200/18

AD SKALPELLE SCALPELS BISTURIES BISTOURIS BISTURI

Operations-Skalpelle
 Operating Knives
 Bisturies para operaciones
 Bistouris pour opérations
 Bisturi per interventi

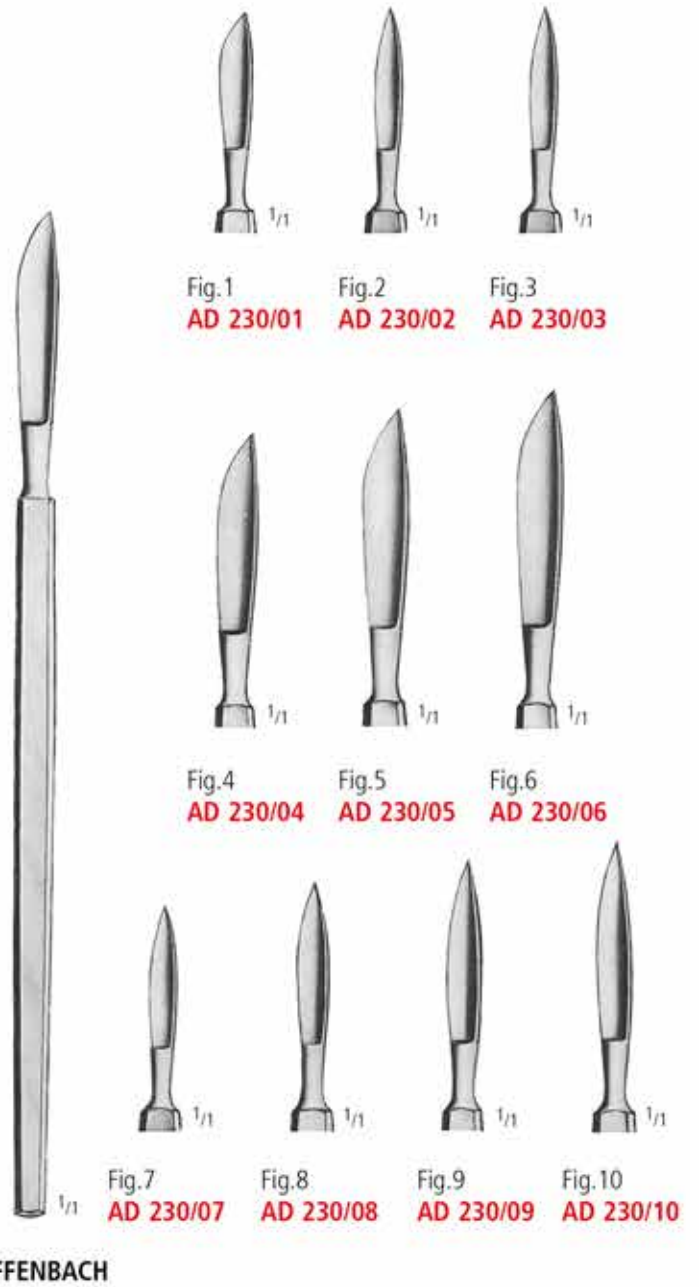
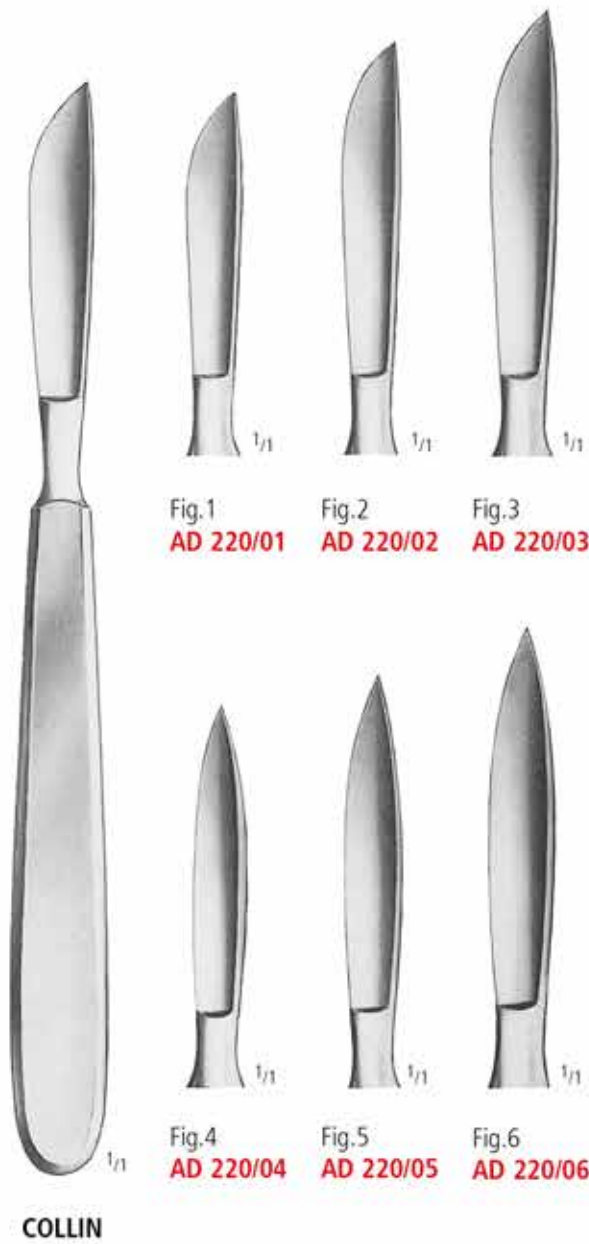

SKALPELLE SCALPELS BISTURIES BISTOURIS BISTURI

Operations-Skalpelle
 Operating Knives
 Bisturías para operaciones
 Bistouris pour opérations
 Bisturi per interventi

AA
 AB
 AC
 AD
 AE
 AF
 AG
 AH
 AI
 AJ
 AK
 AL
 AM
 AN
 AO
 AP
 AQ
 AR
 AS
 AT
 AU
 AV
 AW
 AX
 AY
 AZ



DIEFFENBACH



Fig.1
AD 250/01



Fig.2
AD 250/02



Fig.3
AD 250/03



Fig.4
AD 250/04



Fig.5
AD 250/05



Fig.6
AD 250/06



Fig.7
AD 250/07



Fig.8
AD 250/08



Fig.9
AD 250/09



Fig.15
AD 250/15



Fig.16
AD 250/16

AD SKALPELLE SCALPELS BISTURIES BISTOURIS BISTURI

Amputationsmesser
 Amputating Knives
 Cuchillos para amputación
 Couteaux à amputation
 Coltelli per amputazione



Schnittlängen
 length of blades
 largos de hojas
 longueurs des lames
 lunghezza delle lame

cm	in.
12,0	4 ³ / ₄
13,0	5
16,0	6 ¹ / ₄
17,0	6 ³ / ₄
19,0	7 ¹ / ₂
20,0	8
22,0	8 ³ / ₄
28,0	11

COLLIN

CATLIN

LISTON

LANGENBECK

				AD 325/12
		AD 300/13		
		AD 300/16	AD 310/16	
				AD 320/17
		AD 300/19	AD 310/19	
				AD 320/20
		AD 300/22	AD 310/22	AD 320/22
		AD 300/28		

SKALPELLE SCALPELS BISTURIES BISTOURIS BISTURI

Organmesser, Hirnmesser
 Post Mortem Knives, Brain Knives
 Cuchillos para órganos y cerebro
 Couteaux à autopsie et à cerveaux
 Coltelli per autopsia e cervello



WALB
AD 330/11

WALB
AD 330/14

WALB
AD 330/17

VIRCHOW
AD 336/16

VIRCHOW
AD 336/20

VIRCHOW
AD 336/24

AA
AB
AC
AD
AE
AF
AG
AH
AI
AJ
AK
AL
AM
AN
AO
AP
AQ
AR
AS
AT
AU
AV
AW
AX
AY
AZ

AD SKALPELLE SCALPELS BISTURIES BISTOURIS BISTURI

Abszessmesser, Fistelmesser
 Abscess Knives, Fistula Knives
 Bisturies para abscesos y fistulas
 Bistouris à abcès et fistules
 Bisturi per accessi e fistole



DIEFFENBACH
AD 400/13
 13,0 cm/5"



DIEFFENBACH
AD 401/13
 13,0 cm/5"



SIMON
 23,5 cm/9 1/2"



Fig. 1
AD 430/01



Fig. 2
AD 430/02



Fig. 3
AD 430/03



Fig. 4
AD 430/04

SKALPELLE SCALPELS BISTURIES BISTOURIS BISTURI

Zahnfleischmesser, Transplantationsmesser, Dermatome
 Gum Knives, Transplantation Knives, Dermatome
 Bisturías para encías, Cuchillos para transplatación, Dermatomo
 Couteaux à gencives, Couteaux à transplantation, Dermatome
 Coltelli per gengive, Coltelli per trapianti, Dermatomo

AA
AB
AC
AD
AE
AF
AG
AH
AI
AJ
AK
AL
AM
AN
AO
AP
AQ
AR
AS
AT
AU
AV
AW
AX
AY
AZ
BA
BB
BC
BD
BE
BF
BG
BH
BI
BJ
BK
BL
BM
BN
BO
BP
BQ
BR
BS
BT
BU
BV
BW
BX
BY
BZ
CA
CB
CC
CD
CE
CF
CG
CH
CI
CJ
CK
CL
CM
CN
CO
CP
CQ
CR
CS
CT
CU
CV
CW
CX
CY
CZ
DA
DB
DC
DD
DE
DF
DG
DH
DI
DJ
DK
DL
DM
DN
DO
DP
DQ
DR
DS
DT
DU
DV
DW
DX
DY
DZ
EA
EB
EC
ED
EE
EF
EG
EH
EI
EJ
EK
EL
EM
EN
EO
EP
EQ
ER
ES
ET
EU
EV
EW
EX
EY
EZ
FA
FB
FC
FD
FE
FF
FG
FH
FI
FJ
FK
FL
FM
FN
FO
FP
FQ
FR
FS
FT
FU
FV
FW
FX
FY
FZ
GA
GB
GC
GD
GE
GF
GG
GH
GI
GJ
GK
GL
GM
GN
GO
GP
GQ
GR
GS
GT
GU
GV
GW
GX
GY
GZ
HA
HB
HC
HD
HE
HF
HG
HH
HI
HJ
HK
HL
HM
HN
HO
HP
HQ
HR
HS
HT
HU
HV
HW
HX
HY
HZ
IA
IB
IC
ID
IE
IF
IG
IH
II
IJ
IK
IL
IM
IN
IO
IP
IQ
IR
IS
IT
IU
IV
IW
IX
IY
IZ
JA
JB
JC
JD
JE
JF
JG
JH
JI
JJ
JK
JL
JM
JN
JO
JP
JQ
JR
JS
JT
JU
JV
JW
JX
JY
JZ
KA
KB
KC
KD
KE
KF
KG
KH
KI
KJ
KK
KL
KM
KN
KO
KP
KQ
KR
KS
KT
KU
KV
KW
KX
KY
KZ
LA
LB
LC
LD
LE
LF
LG
LH
LI
LJ
LK
LL
LM
LN
LO
LP
LQ
LR
LS
LT
LU
LV
LW
LX
LY
LZ
MA
MB
MC
MD
ME
MF
MG
MH
MI
MJ
MK
ML
MM
MN
MO
MP
MQ
MR
MS
MT
MU
MV
MW
MX
MY
MZ
NA
NB
NC
ND
NE
NF
NG
NH
NI
NJ
NK
NL
NM
NN
NO
NP
NQ
NR
NS
NT
NU
NV
NW
NX
NY
NZ
OA
OB
OC
OD
OE
OF
OG
OH
OI
OJ
OK
OL
OM
ON
OO
OP
OQ
OR
OS
OT
OU
OV
OW
OX
OY
OZ
PA
PB
PC
PD
PE
PF
PG
PH
PI
PJ
PK
PL
PM
PN
PO
PP
PQ
PR
PS
PT
PU
PV
PW
PX
PY
PZ
QA
QB
QC
QD
QE
QF
QG
QH
QI
QJ
QK
QL
QM
QN
QO
QP
QQ
QR
QS
QT
QU
QV
QW
QX
QY
QZ
RA
RB
RC
RD
RE
RF
RG
RH
RI
RJ
RK
RL
RM
RN
RO
RP
RQ
RR
RS
RT
RU
RV
RW
RX
RY
RZ
SA
SB
SC
SD
SE
SF
SG
SH
SI
SJ
SK
SL
SM
SN
SO
SP
SQ
SR
SS
ST
SU
SV
SW
SX
SY
SZ
TA
TB
TC
TD
TE
TF
TG
TH
TI
TJ
TK
TL
TM
TN
TO
TP
TQ
TR
TS
TT
TU
TV
TW
TX
TY
TZ
UA
UB
UC
UD
UE
UF
UG
UH
UI
UJ
UK
UL
UM
UN
UO
UP
UQ
UR
US
UT
UU
UV
UW
UX
UY
UZ
VA
VB
VC
VD
VE
VF
VG
VH
VI
VJ
VK
VL
VM
VN
VO
VP
VQ
VR
VS
VT
VU
VV
VW
VX
VY
VZ
WA
WB
WC
WD
WE
WF
WG
WH
WI
WJ
WK
WL
WM
WN
WO
WP
WQ
WR
WS
WT
WU
WV
WW
WX
WY
WZ
XA
XB
XC
XD
XE
XF
XG
XH
XI
XJ
XK
XL
XM
XN
XO
XP
XQ
XR
XS
XT
XU
XV
XW
XX
XY
XZ
YA
YB
YC
YD
YE
YF
YG
YH
YI
YJ
YK
YL
YM
YN
YO
YP
YQ
YR
YS
YT
YU
YV
YW
YX
YY
YZ
ZA
ZB
ZC
ZD
ZE
ZF
ZG
ZH
ZI
ZJ
ZK
ZL
ZM
ZN
ZO
ZP
ZQ
ZR
ZS
ZT
ZU
ZV
ZW
ZX
ZY
ZZ



AD 435/01
No. 1



AD 435/02
No. 2



AD 435/03
No. 3



THIERSCH
AD 450/20
20,0 cm/8"



REHN
AD 455/25
25,0 cm/10"

Dermatome
Dermatomes
Dermatomos
Dermatomes
Dermatomi



AD 495/31
15,5 cm/6"

WATSON
AD 495/30
30,5 cm/12"
0,1 - 2,0 mm

HUMBY
AD 495/32
32,0 cm/12³/₄"
0,1 - 1,2 mm



SCHINK
AD 500/00
30,0 cm/12"



AD 510/01



AD 510/02

SKALPELLE SCALPELS BISTURIES BISTOURIS BISTURI

Rasierklingen, Klingenbrecher
 Razor Blades, Blade Breakers
 Hojas de afeitar, Pinzas para romper hojas
 Lames de rasoir, Pincettes pour casser les lames
 Lamette da barba, Pinze per rompere la lamette

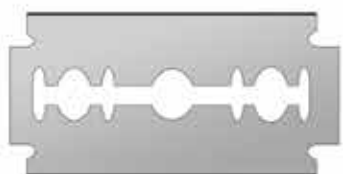

RASIERKLINGEN, VERPACKUNGSEINHEIT 10 STÜCK
 RAZOR BLADES, PACKING UNIT 10 PIECES
 HOJAS DE AFEITAR, UNIDAD DE VENTA 10 PZ
 LAMES DE RASOIR, UNITÉ À 10 PIÈCES
 LAMETTE DA BARBA, UNITÀ DI VENDITA 10 PZ

AD 540/00



TROUTMAN-CHRIS
AD 550/09
 Ø 5,5 mm
 9,0 cm/3 1/2"



TROUTMAN-CHRIS
AD 551/09
 Ø 5,5 mm
 9,0 cm/3 1/2"



AD 552/11
 11,0 cm/4 1/3"



CASTROVIEJO
AD 554/13
 Ø 8 mm
 13,0 cm/5"

AA
 AB
 AC
AD
 AE
 AF
 AK
 AL
 AM
 AO
 AP
 AR
 KA
 KD
 KU
 KY

NAHT
SUTURE
SUTURA
SUTURE
SUTURA

AE

nopa[®] instruments



Nadelhalter
Needle Holders
Porta-agujas
Porte-aiguilles
Portaghi



BOYNTON
AE 036/12
12,0 cm/4³/₄"



AE 038/16 **AE 039/16**

ARRUGA
16,0 cm/6¹/₄"



DERF
AE 050/12
12,0 cm/4³/₄"



DERF-CONVERSE
AE 052/12
12,5 cm/5"



COLLIER
AE 056/12
12,5 cm/5"



DOYEN
AE 058/12
12,5 cm/5"

NAHT SUTURE SUTURA SUTURE SUTURA

Nadelhalter
Needle Holders
Porta-agujas
Porte-aiguilles
Portaghi

AA
AB
AC
AD
AE
AF
AG
AH
AI
AJ
AK
AL
AM
AN
AO
AP
AQ
AR
AS
AT
AU
AV
AW
AX
AY
AZ



WEBSTER
AE 060/13
13,0 cm/5"

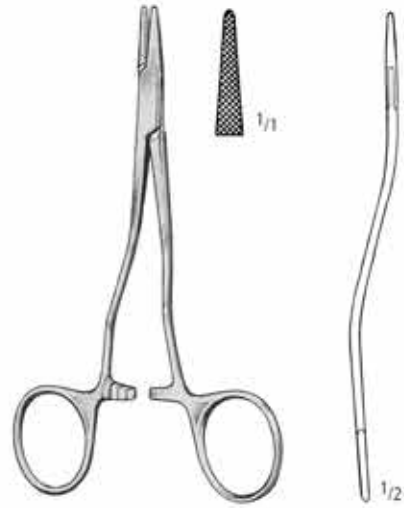

KILNER
AE 063/13
13,0 cm/5"



HALSEY
13,0 cm/5"

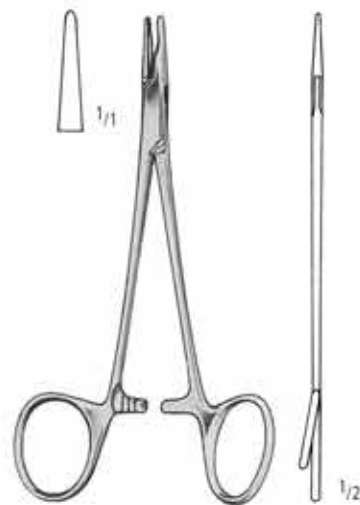

NEIVERT
AE 068/13
13,0 cm/5"

AE NAHT SUTURE SUTURA SUTURE SUTURA

Nadelhalter
Needle Holders
Porta-agujas
Porte-aiguilles
Portaghi



CRILE-WOOD
15,0 cm/6"
18,0 cm/7"
AE 070/15
AE 070/18



BABY-CRILE-WOOD
15,0 cm/6"
AE 072/15



CARROLL
15,0 cm/6"
AE 074/15



CRILE-MURRAY
15,0 cm/6"
AE 076/15

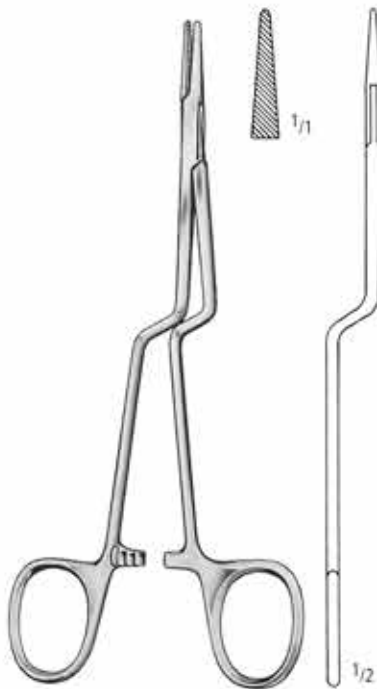

JACOBSON
18,0 cm/7"
AE 077/18



BOZEMANN



AE 079/20
20,0 cm/8"



AE 079/24
24,0 cm/9 1/2"



AE 079/26
26,0 cm/10 1/2"

NAHT SUTURE SUTURA SUTURE SUTURA

Nadelhalter
Needle Holders
Porta-agujas
Porte-aiguilles
Portaghi



AE 080/18 18,0 cm/7"
AE 080/26 26,0 cm/10½"

SAROT



AE 082/13 13,0 cm/5"
AE 082/18 18,0 cm/7"

BROWN



NEW ORLEANS
AE 086/18
18,0 cm/7"



AE 088/15 15,0 cm/6"
AE 088/17 17,0 cm/6¾"

SENNING
(Schwed. Modell)



AE 090/17
17,0 cm/6¾"

M.G.H.
(Mass.-General-Hospital)



ADSON
AE 094/18
18,0 cm/7"

AA
AB
AC
AD
AE
AF
AK
AL
AM
AO
AP
AR
KA
KD
KU
KY

AE NAHT SUTURE SUTURA SUTURE SUTURA

Nadelhalter
Needle Holders
Porta-agujas
Porte-aiguilles
Portaghi



MAYO-HEGAR



AE 100/14
14,0 cm/5¹/₂"



AE 100/16
16,0 cm/6¹/₄"



AE 100/18
18,0 cm/7"



AE 100/20
20,0 cm/8"



AE 100/24
24,0 cm/9¹/₂"



AE 100/26
26,0 cm/10¹/₄"



AE 100/30
30,0 cm/12"

MAYO-HEGAR-DELICATE

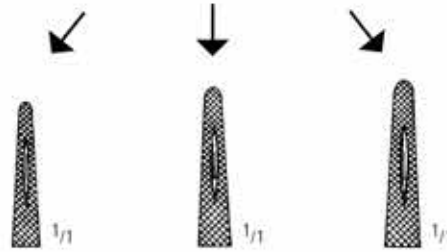

AE 110/16
16,0 cm/6¹/₄"

AE 110/18
18,0 cm/7"

AE 110/20
20,0 cm/8"



BAUMGARTNER
AE 112/14
14,0 cm/5¹/₂"



HEANEY

AE 113/21
21,0 cm/8¹/₄"



AE 113/36
36,0 cm/14"



JAMESON
AE 126/23
23,5 cm/9¹/₃"



MASSON
AE 130/27
27,0 cm/10³/₄"

NAHT SUTURE SUTURA SUTURE SUTURA

Nadelhalter
Needle Holders
Porta-agujas
Porte-aiguilles
Portaghi



FINOCCHIETTO
AE 136/27
27,0 cm/10³/₄"



WANGENSTEEN
AE 140/27
27,0 cm/10³/₄"



WANGENSTEEN-DELICATE
AE 142/27
27,5 cm/10¹/₂"



AE 145/20 20,0 cm/8"
AE 145/23 23,0 cm/9"



WERTHEIM
20,0 cm/8" **AE 147/20**
24,0 cm/9¹/₂" **AE 147/24**



AE 150/14 14,0 cm/5¹/₂"
AE 150/17 17,0 cm/6³/₄"
AE 150/19 19,0 cm/7¹/₂"

OLSEN-HEGAR

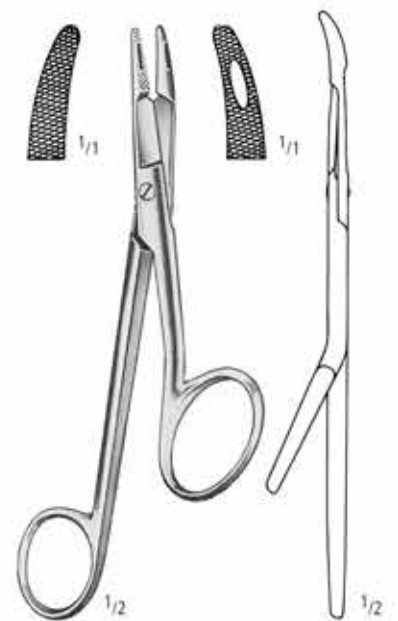

GILLIES
AE 155/16
16,0 cm/6¹/₄"

AA
AB
AC
AD
AE
AF
AK
AL
AM
AO
AP
AR
KA
KD
KU
KY

AE NAHT SUTURE SUTURA SUTURE SUTURA

Nadelhalter
Needle Holders
Porta-agujas
Porte-aiguilles
Portaghi



MATHIEU



1/11

AE 200/14
14,0 cm/5 1/2"



1/11

AE 200/17
17,0 cm/6 3/4"



1/11

AE 200/20
20,0 cm/8"



1/11

AE 200/24
24,0 cm/9 1/2"



MATHIEU-DELICATE



1/11

AE 210/14
14,0 cm/5 1/2"



1/11

AE 210/17
17,0 cm/6 3/4"



MATHIEU



1/11

AE 214/17
17,0 cm/6 3/4"



1/11

AE 214/20
20,0 cm/8"



1/11

AE 214/24
24,0 cm/9 1/2"

NAHT SUTURE SUTURA SUTURE SUTURA

Nadelhalter
Needle Holders
Porta-agujas
Porte-aiguilles
Portaghi



LICHTENBERG



AE 216/20
20,0 cm/8"



AE 216/25
25,0 cm/10"



ZWEIFEL



AE 222/20
20,0 cm/8"



AE 222/23
23,0 cm/9"



CRILE
AE 224/15
15,0 cm/6"



AA
AB
AC
AD
AE
AF
AK
AL
AM
AO
AP
AR
KA
KD
KU
KY

Nadelhalter
 Needle Holders
 Porta-agujas
 Porte-aiguilles
 Portaghi



TOENNIS
AE 226/18
 18,0 cm/7"



LANGENBECK

AE 228/18
 18,0 cm/7"

AE 228/20
 20,0 cm/8"



HÖSEL
AE 230/25
 25,0 cm/10"

Nadelhalter
Needle Holders
Porta-agujas
Porte-aiguilles
Portaghi

AA

AB

AC

AD

AE

AF

AK

AL

AM

AO

AP

AR

KA

KD

KU

KY



AE 301/01



AE 301/02



AE 301/03

YOUNG-HRYNTSCHAK

AE 300/24

24,0 cm/9 1/2"

- mit 1 Nadel **AE 301/01**
- with 1 needle **AE 301/01**
- con 1 aguja **AE 301/01**
- avec 1 aiguille **AE 301/01**
- con 1 ago **AE 301/01**

AE NAHT SUTURE SUTURA SUTURE SUTURA

Hartmetalleinsatzplättchen mit Pyramidenprofil
 Tungsten Carbide Tips with pyramidal profile
 Bocas de carburo de tungsteno con perfil de estructura piramidal
 Plaquettes en carbure de tungstène avec profil pyramidal
 Placche di carburo di tungsteno con profilo in forma piramidale

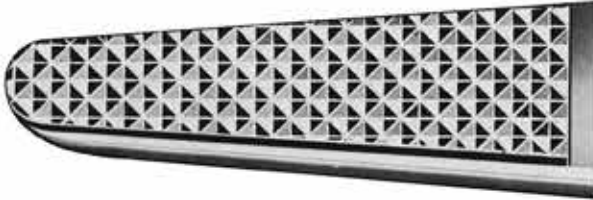

Teilung:	0,5 mm	Für Nahtmaterial 3/0 und größer
Serration:	0,5 mm	For suture sizes 3/0 and larger
Graduación:	0,5 mm	Para sutura 3/0 y más grande
Graduation:	0,5 mm	Pour suture 3/0 et plus grand
Graduazione:	0,5 mm	Per sutura 3/0 e più grande

"STANDARD"

(Mayo-Hegar, Mathieu, Bozeman,
 New Orleans, Stratte, etc.)

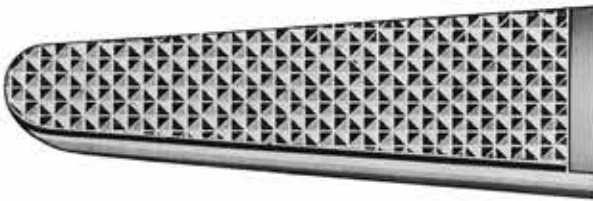

Teilung:	0,4 mm	Für Nahtmaterial zwischen 3/0 und 6/0
Serration:	0,4 mm	For suture sizes between 3/0 and 6/0
Graduación:	0,4 mm	Para suturas entre 3/0 y 6/0
Graduation:	0,4 mm	Pour sutures entre 3/0 et 6/0
Graduazione:	0,4 mm	Per sutura tra 3/0 e 6/0

"FINE"

(Crile-Wood, Halsey, DeBakey, Ryder,
 etc.)



Teilung:	0,2 mm	Für Nahtmaterial zwischen 7/0 und 10/0
Serration:	0,2 mm	For suture sizes between 7/0 and 10/0
Graduación:	0,2 mm	Para suturas entre 7/0 y 10/0
Graduation:	0,2 mm	Pour sutures entre 7/0 et 10/0
Graduazione:	0,2 mm	Per sutura tra 7/0 e 10/0

"MICRO"

(Micro Ryder, Microvascular, Castroviejo,
 etc.)



glatt	Für extrem feines Nahtmaterial
smooth	For the smallest suture sizes available
lisa	Para suturas extremamente finas
lisses	Pour matériel de suture extrêmement fin
liscio	Per materiale di sutura finissima

"SMOOTH"

(Eufrate Pasquè, Castroviejo, Jacobson, etc.)

NAHT SUTURE SUTURA SUTURE SUTURA

nopa-Service, Ersatzteile und Aufarbeitung aller Fabrikate
 nopa-Service, Spare Inserts and Refurbishing of all brands
 Servicio-nopa, piezas de recambio y renovar de todas las marcas
 Service-nopa, pièces de rechange et remise à neuf de toutes les marques
 Servizio-nopa, pezzi di ricambio e riparazione di tutte le marche

TUC-Einsätze
TUC-Inserts
TUC-Bocas
TUC-Plaquettes
TUC-Placche

AE 380/15	Smooth, 15 mm
AE 380/17	Smooth, 17 mm
AE 380/19	Smooth, 19 mm
AE 382/15	Micro, 0.2, 15 mm
AE 382/17	Micro, 0.2, 17 mm
AE 382/19	Micro, 0.2, 19 mm
AE 384/15	Fine, 0.4, 15 mm
AE 384/17	Fine, 0.4, 17 mm
AE 384/19	Fine, 0.4, 19 mm
AE 385/15	Standard, 0.5, 15 mm
AE 385/17	Standard, 0.5, 17 mm
AE 385/19	Standard, 0.5, 19 mm

AA

AB

AC

AD

AE

AF

AG

AH

AI

AJ

AK

AL

AM

AN

AO

AP

AQ

AE NAHT SUTURE SUTURA SUTURE SUTURA

Nadelhalter mit Hartmetalleinsätzen
 Needle Holders with Tungsten Carbide Inserts
 Porta-agujas con bocas de carburo de Tungsteno
 Porte-aiguilles à mors en carbure de tungstène
 Portaghi con placche di carburo di tungsteno



MAYO-HEGAR



AE 400/14
 14,0 cm/5¹/₂"



AE 400/16
 16,0 cm/6¹/₄"



AE 400/18
 18,0 cm/7"



AE 400/20
 20,0 cm/8"



AE 400/24
 24,0 cm/9¹/₂"



AE 400/26
 26,0 cm/10¹/₂"



AE 400/30
 30,0 cm/12"



AE 400/36
 36,0 cm/14"



**DE-BAKEY
 (MAYO-HEGAR-DELICATE)**



AE 420/18
 18,0 cm/7"



AE 420/20
 20,0 cm/8"



AE 420/23
 23,0 cm/9"



AE 420/26
 26,0 cm/10¹/₂"



AE 420/31
 31,0 cm/12¹/₄"

NAHT SUTURE SUTURA SUTURE SUTURA

Nadelhalter mit Hartmetalleinsätzen
 Needle Holders with Tungsten Carbide Inserts
 Porta-agujas con bocas de carburo de Tungsteno
 Porte-aiguilles à mors en carbure de tungstène
 Portaghi con placche di carburo di tungsteno



RYDER/FRENCH-EYE

- | | | | | | |
|---|---|---|---|---|---|
|  |  |  |  |  |  |
| AE 430/13
13,0 cm/5" | AE 430/15
15,0 cm/6" | AE 430/18
18,0 cm/7" | AE 430/20
20,0 cm/8" | AE 430/23
23,0 cm/9" | AE 430/26
26,0 cm/10 ^{1/2} " |



MICRO RYDER

- | | | | | | |
|---|---|---|---|---|---|
|  |  |  |  |  |  |
| AE 434/13
13,0 cm/5" | AE 434/15
15,0 cm/6" | AE 434/18
18,0 cm/7" | AE 434/20
20,0 cm/8" | AE 434/23
23,0 cm/9" | AE 434/26
26,0 cm/10 ^{1/2} " |



- | | | | |
|---|---|---|---|
|  |  |  |  |
| AE 436/14
14,0 cm/5 ^{1/2} " | AE 436/18
18,0 cm/7" | AE 436/20
20,0 cm/8" | AE 436/23
23,0 cm/9" |



- | | | | |
|---|---|---|---|
|  |  |  |  |
| AE 438/14
14,0 cm/5 ^{1/2} " | AE 438/18
18,0 cm/7" | AE 438/20
20,0 cm/8" | AE 438/23
23,0 cm/9" |

EUFRATE PASQUÉ

MICROVASCULAR

extrem fein
 extremely delicate
 muy fino
 très fin
 molto fino

AA
AB
AC
AD
AE
AF
AK
AL
AM
AO
AP
AR
KA
KD
KU
KY

AE NAHT SUTURE SUTURA SUTURE SUTURA

Nadelhalter mit Hartmetalleinsätzen
 Needle Holders with Tungsten Carbide Inserts
 Porta-agujas con bocas de carburo de Tungsteno
 Porte-aiguilles à mors en carbure de tungstène
 Portaghi con placche di carburo di tungsteno



CARROLL
AE 440/15
 15,0 cm/6"

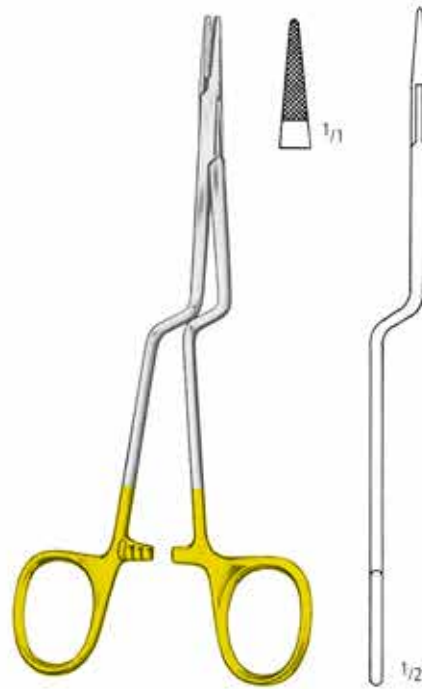

JACOBSON
AE 444/18
 18,0 cm/7"



NEW ORLEANS
AE 446/18
 18,0 cm/7"



SENNING
 (SWEDISH PATTERN)



AE 448/15
 15,0 cm/6"



AE 448/17
 17,0 cm/6³/₄"

NAHT SUTURE SUTURA SUTURE SUTURA

Nadelhalter mit Hartmetalleinsätzen
 Needle Holders with Tungsten Carbide Inserts
 Porta-agujas con bocas de carburo de Tungsteno
 Porte-aiguilles à mors en carbure de tungstène
 Portaghi con placche di carburo di tungsteno



DERF
AE 450/12
 12,5 cm/5"



CONVERSE
AE 452/12
 12,5 cm/5"

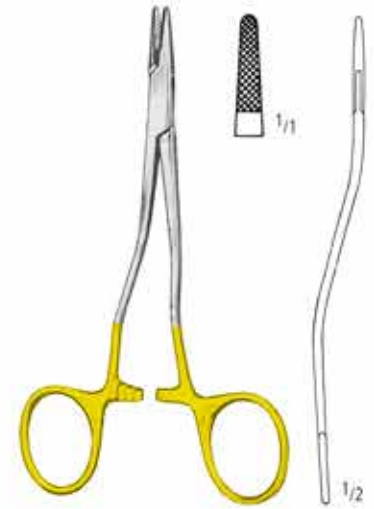

KILNER
AE 455/13
 13,5 cm/5 1/4"



NEIVERT
AE 456/13
 13,0 cm/5"



WEBSTER
AE 460/13
 13,0 cm/5"

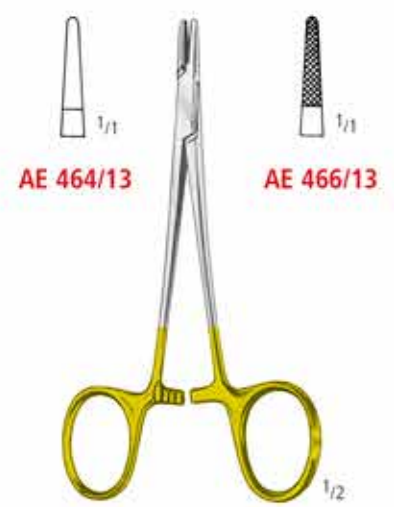

HALSEY
 13,0 cm/5"

AA
 AB
 AC
 AD
AE
 AF
 AG
 AH
 AI
 AJ
 AK
 AL
 AM
 AN
 AO
 AP
 AQ
 AR
 AS
 AT
 AU
 AV
 AW
 AX
 AY
 AZ

AE NAHT SUTURE SUTURA SUTURE SUTURA

Nadelhalter mit Hartmetalleinsätzen
 Needle Holders with Tungsten Carbide Inserts
 Porta-agujas con bocas de carburo de Tungsteno
 Porte-aiguilles à mors en carbure de tungstène
 Portaghi con placche di carburo di tungsteno



BABY-CRILE-WOOD
AE 468/15
 15,0 cm/6"



CRILE-WOOD
AE 469/15
 15,0 cm/6"



CRILE-WOOD
AE 470/15
 15,0 cm/6"

nopa[®]
TUC

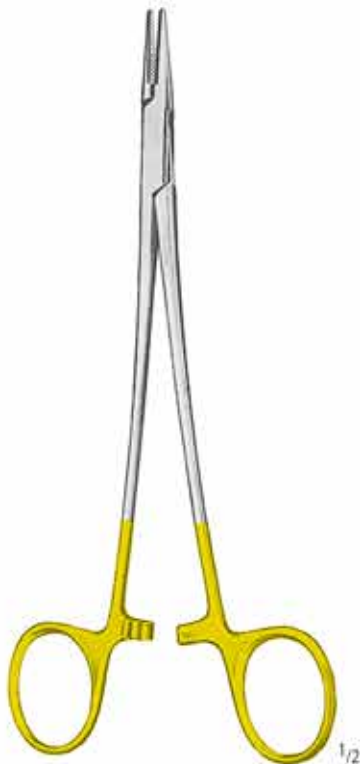

CRILE-WOOD



AE 470/18
 18,0 cm/7"



AE 470/20
 20,0 cm/8"



AE 470/23
 23,0 cm/9"



AE 471/18
 18,0 cm/7"



AE 471/23
 23,0 cm/9"



AE 471/36
 36,0 cm/14"

NAHT SUTURE SUTURA SUTURE SUTURA

Nadelhalter mit Hartmetalleinsätzen
 Needle Holders with Tungsten Carbide Inserts
 Porta-agujas con bocas de carburo de Tungsteno
 Porte-aiguilles à mors en carbure de tungstène
 Portaghi con placche di carburo di tungsteno

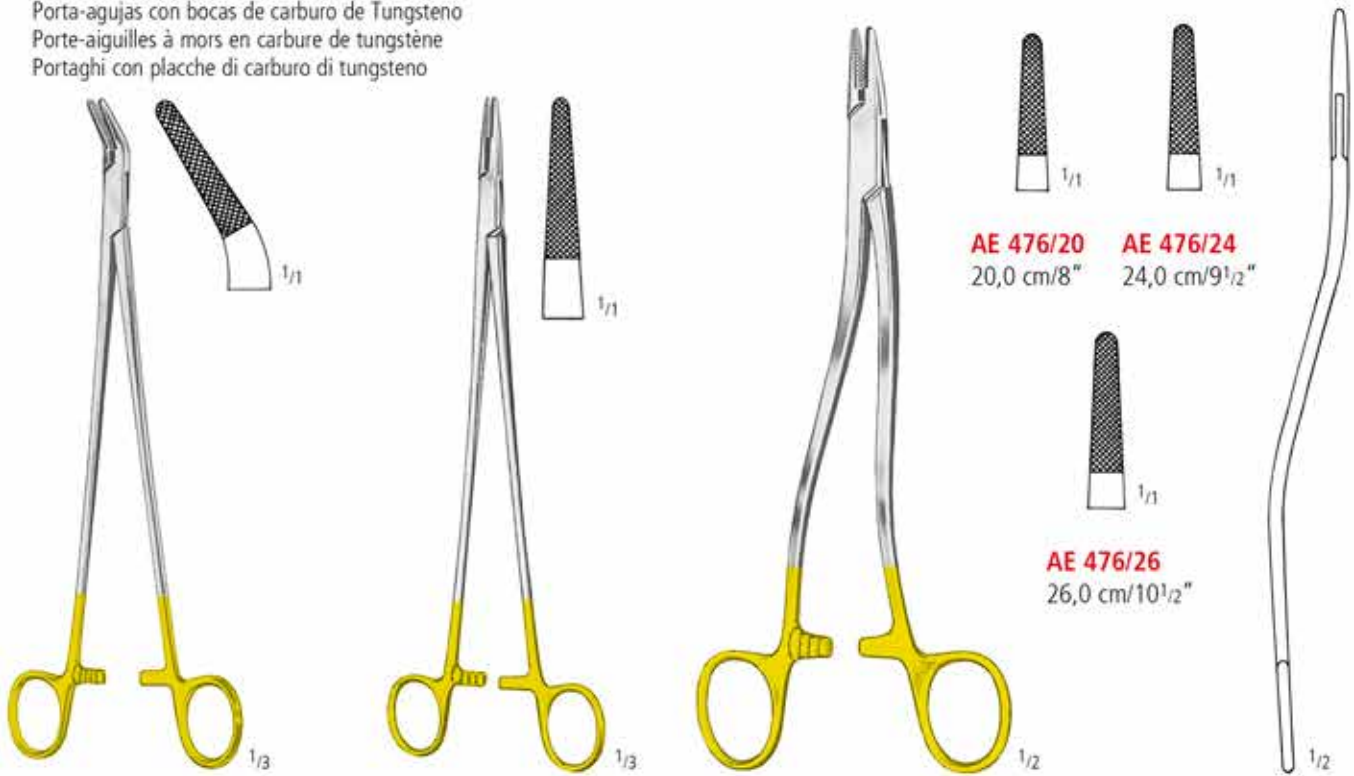

FINOCCHIETTO
AE 472/27
 27,0 cm/10³/₄"

WANGENSTEIN
AE 474/27
 27,0 cm/10³/₄"

BOZEMANN

AE 476/20
 20,0 cm/8"

AE 476/24
 24,0 cm/9¹/₂"

AE 476/26
 26,0 cm/10¹/₂"

nopa®
TUC



STRATTE
AE 478/23
 23,0 cm/9"

SAROT

MASSON
AE 482/27
 27,0 cm/10³/₄"

AA
 AB
 AC
 AD
AE
 AF
 AK
 AL
 AM
 AO
 AP
 AR
 KA
 KD
 KU
 KY

AE NAHT SUTURE SUTURA SUTURE SUTURA

Nadelhalter mit Hartmetalleinsätzen
 Needle Holders with Tungsten Carbide Inserts
 Porta-agujas con bocas de carburo de Tungsteno
 Porte-aiguilles à mors en carbure de tungstène
 Portaghi con placche di carburo di tungsteno



WERTHEIM



AE 487/20
20,0 cm/8"



AE 487/24
24,0 cm/9 1/2"



AE 487/30
30,0 cm/12"



OLSEN-HEGAR



AE 488/14
14,0 cm/5 1/2"



AE 488/17
17,0 cm/6 3/4"



AE 488/19
19,0 cm/7 1/2"



OLSEN-HEGAR-USA
AE 489/16
16,0 cm/6 1/4"

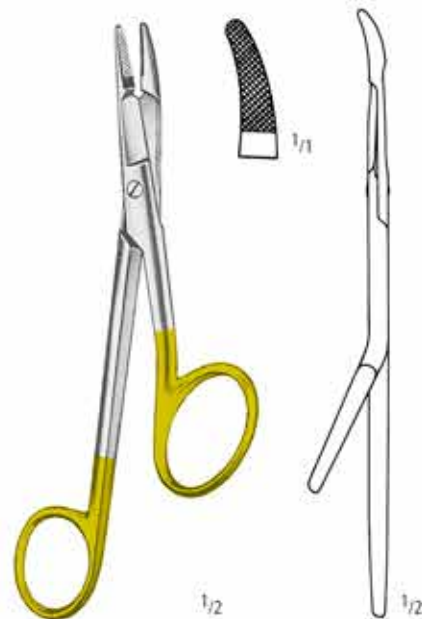

GILLIES
AE 490/16
16,0 cm/6 1/4"



NAHT SUTURE SUTURA SUTURE SUTURA

Nadelhalter mit Hartmetalleinsätzen
 Needle Holders with Tungsten Carbide Inserts
 Porta-agujas con bocas de carburo de Tungsteno
 Porte-aiguilles à mors en carbure de tungstène
 Portaghi con placche di carburo di tungsteno



MATHIEU



AE 500/14
14,0 cm/5 1/2"



AE 500/17
17,0 cm/6 3/4"



AE 500/20
20,0 cm/8"



AE 500/24
24,0 cm/9 1/2"



MATHIEU



AE 501/14
14,0 cm/5 1/2"



MATHIEU



AE 502/17
17,0 cm/6 3/4"



AE 502/20
20,0 cm/8"



AE 502/23
23,0 cm/9"



MATHIEU-DELICATE



AE 504/14
14,0 cm/5 1/2"



AE 504/17
17,0 cm/6 3/4"



AE 504/20
20,0 cm/8"



METZENBAUM



AE 507/17
17,0 cm/6 3/4"



AE 507/19
19,5 cm/7 1/2"

AA
AB
AC
AD
AE
AF
AK
AL
AM
AO
AP
AR
KA
KD
KU
KY

Nadelhalter mit Hartmetalleinsätzen
 Needle Holders with Tungsten Carbide Inserts
 Porta-agujas con bocas de carburo de Tungsteno
 Porte-aiguilles à mors en carbure de tungstène
 Portaghi con placche di carburo di tungsteno

nopa[®]
TUC



MATHIEU-RYDER



AE 510/17
 17,0 cm/6³/₄"



AE 510/20
 20,0 cm/8"



AE 510/24
 24,0 cm/9¹/₂"



MATHIEU-RYDER VASCULAR



AE 512/17
 17,0 cm/6³/₄"



AE 512/20
 20,0 cm/8"



AE 512/24
 24,0 cm/9¹/₂"

NAHT SUTURE SUTURA SUTURE SUTURA

Nadelhalter mit Hartmetalleinsätzen
 Needle Holders with Tungsten Carbide Inserts
 Porta-agujas con bocas de carburo de Tungsteno
 Porte-aiguilles à mors en carbure de tungstène
 Portaghi con placche di carburo di tungsteno



AE 514/12



AE 515/12



AE 516/16



AE 517/16



BOYNTON
12,0 cm/4³/₄"

nopa[®]
TUC

ARRUGA
16,0 cm/6¹/₄"



TOENNIS
AE 522/18
18,0 cm/7"



LICHTENBERG
AE 524/20
20,0 cm/8"

HÖSEL
AE 520/25
25,0 cm/10"

AA
AB
AC
AD
AE
AF
AG
AH
AI
AJ
AK
AL
AM
AN
AO
AP
AQ
AR
AS
AT
AU
AV
AW
AX
AY
AZ

AE NAHT SUTURE SUTURA SUTURE SUTURA

Nadelhalter mit Hartmetalleinsätzen
 Needle Holders with Tungsten Carbide Inserts
 Porta-agujas con bocas de carburo de Tungsteno
 Porte-aiguilles à mors en carbure de tungstène
 Portaghi con placche di carburo di tungsteno



ZWEIFEL



AE 530/20
20,0 cm/8"



AE 530/23
23,0 cm/9"



LUETHY-BECK
AE 535/20
20,0 cm/8"

LANGENBECK

LANGENBECK-DELICATE

LANGENBECK-RYDER



AE 540/16
16,0 cm/6¹/₄"



AE 540/18
18,0 cm/7"



AE 540/20
20,0 cm/8"



AE 542/18
18,0 cm/7"



AE 542/20
20,0 cm/8"



AE 542/23
23,0 cm/9"



AE 544/18
18,0 cm/7"



AE 544/20
20,0 cm/8"



AE 544/23
23,0 cm/9"

NAHT SUTURE SUTURA SUTURE SUTURA

Drahtzangen mit Hartmetalleinsätzen
 Wire Twisting Forceps with Tungsten Carbide Inserts
 Pinzas para torcer hilos con bocas de carburo de Tungsteno
 Pincès à torsader le fil à mors en carbure de tungstène
 Pinze per ritorcere fili con placche di carburo di tungsteno



STERNUM



18,5 cm/7¼"

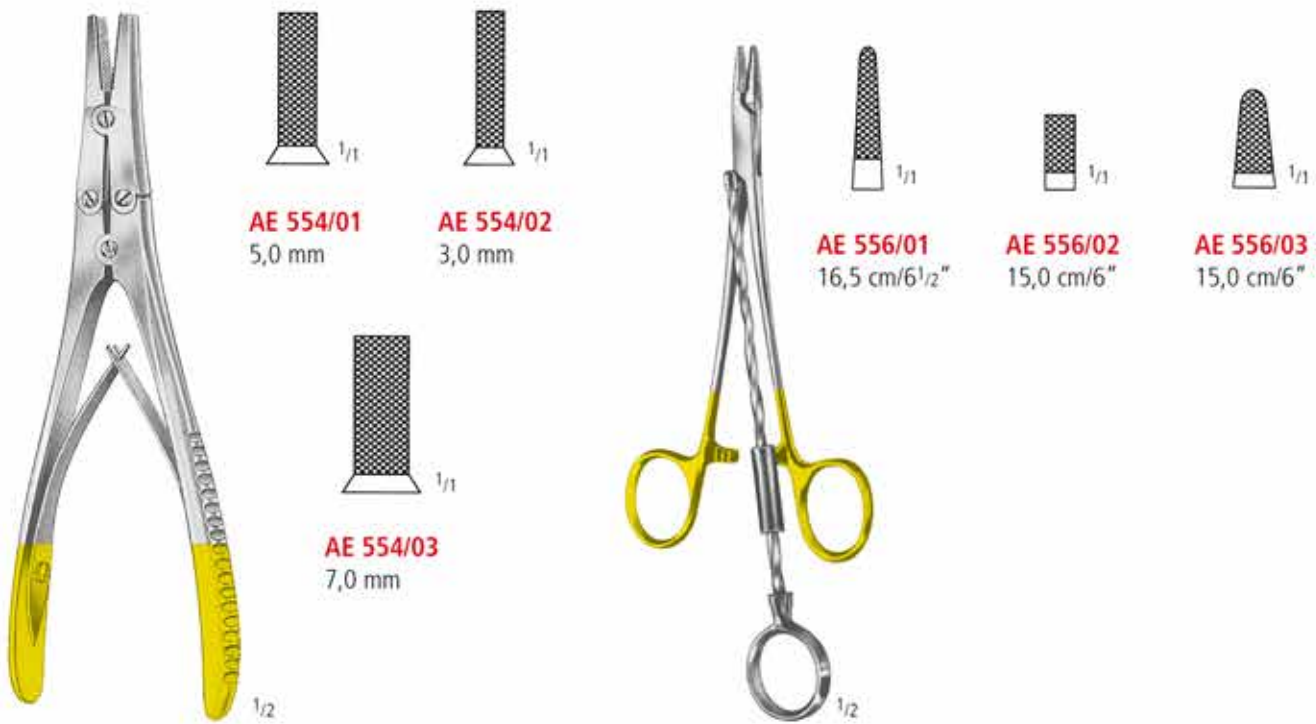

18,0 cm/7"

CORWIN

AA
AB
AC
AD
AE
AF
AK
AL
AM
AO
AP
AR
KA
KD
KU
KY

AE NAHT SUTURE SUTURA SUTURE SUTURA

Mikro-Nadelhalter mit Hartmetalleinsätzen
 Micro-Needle Holders with Tungsten Carbide Inserts
 Micro-Porta-agujas con bocas de carburo de Tungsteno
 Micro-Porte-aiguilles à mors en carbure de tungstène
 Micro-Portaghi con placche di carburo di tungsteno



AE 570/14

AE 571/14

CASTROVIEJO
 14,0 cm/5 1/2"



AE 572/14

AE 573/14

CASTROVIEJO
 14,0 cm/5 1/2"

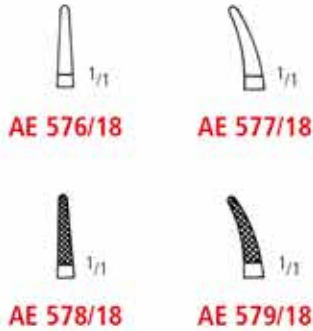

AE 576/18

AE 577/18

AE 578/18

AE 579/18

18,0 cm/7"



AE 580/01

AE 580/02

JACOBSON
 21,0 cm/8 1/4"

NAHT SUTURE SUTURA SUTURE SUTURA

Mikro-Nadelhalter mit Hartmetalleinsätzen
 Micro-Needle Holders with Tungsten Carbide Inserts
 Micro-Porta-agujas con bocas de carburo de Tungsteno
 Micro-Porte-aiguilles à mors en carbure de tungstène
 Micro-Portaghi con placche di carburo di tungsteno



DIETHRICH



AE 582/16
16,0 cm/6¹/₄"



AE 582/18
18,0 cm/7"



AE 582/20
20,0 cm/8"



AE 582/23
23,0 cm/9"



AE 582/26
26,0 cm/10¹/₂"



KALT
AE 584/14
13,5 cm/5¹/₄"



CASTROVIEJO
AE 586/13
13,0 cm/5"



POTTS-SMITH
AE 588/22
22,0 cm/8³/₄"

AA
AB
AC
AD
AE
AF
AG
AH
AI
AJ
AK
AL
AM
AN
AO
AP
AQ
AR
AS
AT
AU
AV
AW
AX
AY
AZ

AE NAHT SUTURE SUTURA SUTURE SUTURA

Mikro-Nadelhalter mit Rundgriff
 Micro-Needle Holders with Pen-Type Handle
 Micro-Porta-agujas con mango redondo
 Micro-Porte-aiguilles à manches rondes
 Micro-Portaghi con manici rotondi

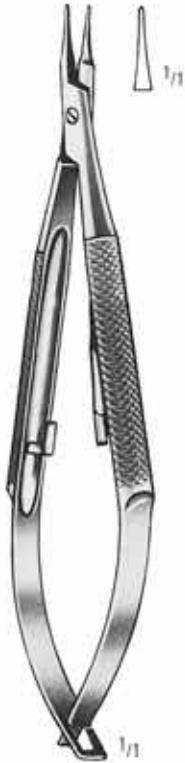

**BARRAQUER-
TROUTMAN**
AE 600/10
 10,0 cm/4"



**BARRAQUER-
TROUTMAN**
AE 601/10
 10,0 cm/4"



**BARRAQUER-
TROUTMAN**
AE 602/10
 10,0 cm/4"



**BARRAQUER-
TROUTMAN**
AE 603/10
 10,0 cm/4"



BARRAQUER
AE 605/11
 11,0 cm/4 1/3"



BARRAQUER
AE 605/13
 13,0 cm/5"



BARRAQUER
AE 605/14
 14,0 cm/5 1/2"



BARRAQUER
AE 606/14
 14,0 cm/5 1/2"



BARRAQUER
AE 607/14
 14,0 cm/5 1/2"

NAHT SUTURE SUTURA SUTURE SUTURA

Mikro-Nadelhalter mit Rundgriff
 Micro-Needle Holders with Pen-Type Handle
 Micro-Porta-agujas con mango redondo
 Micro-Porte-aiguilles à manches rondes
 Micro-Portaghi con manici rotondi



TROUTMAN
AE 609/01
 12,0 cm/4³/₄"



TROUTMAN
AE 609/02
 12,0 cm/4³/₄"



AE 610/15



AE 611/15



AE 612/15



AE 613/15

REILL
 15,0 cm/6"

REILL
 15,0 cm/6"

AA
 AB
 AC
 AD
AE
 AF
 AK
 AL
 AM
 AO
 AP
 AR
 KA
 KD
 KU
 KY

AE NAHT SUTURE SUTURA SUTURE SUTURA

Mikro-Nadelhalter mit Rundgriff
 Micro-Needle Holders with Pen-Type Handle
 Micro-Porta-agujas con mango redondo
 Micro-Porte-aiguilles à manches rondes
 Micro-Portaghi con manici rotondi



AE 621/14
 14,0 cm/5 1/2"



AE 623/14
 14,0 cm/5 1/2"

...für Rechtshänder
 ...for right handed surgeons
 ...para diestros
 ...pour des droitiers
 ...per destrimani

Maulteil konkav/konvex
 Jaws concave/convex
 Bocas concavas/convexas
 Mors concave/convexe
 Morso concavo/convesso



AE 625/14
 14,0 cm/5 1/2"

...für Linkshänder
 ...for left handed surgeons
 ...para zurdos
 ...pour gaucher
 ...per mancini

NAHT SUTURE SUTURA SUTURE SUTURA

Mikro-Nadelhalter mit Rundgriff
 Micro-Needle Holders with Pen-Type Handle
 Micro-Porta-agujas con mango redondo
 Micro-Porte-aiguilles à manches rondes
 Micro-Portaghi con manici rotondi



AE 630/18
 18,0 cm/7"



AE 631/18
 18,0 cm/7"



AE 632/18
 18,0 cm/7"



AE 633/18
 18,0 cm/7"

AA
 AB
 AC
 AD
AE
 AF
 AG
 AH
 AI
 AJ
 AK
 AL
 AM
 AN
 AO
 AP
 AQ
 AR
 AS
 AT
 AU
 AV
 AW
 AX
 AY
 AZ

AE NAHT SUTURE SUTURA SUTURE SUTURA

Mikro-Nadelhalter
 Micro-Needle Holders
 Micro-Porta-agujas
 Micro-Porte-aiguilles
 Micro-Portaghi

	AE 650/09		AE 652/09		AE 656/14		AE 657/14		AE 660/14		AE 661/14
	AE 651/09		AE 653/09		AE 658/14		AE 659/14		AE 662/14		AE 663/14
CASTROVIEJO		CASTROVIEJO		CASTROVIEJO		CASTROVIEJO		CASTROVIEJO		CASTROVIEJO	
9,0 cm/3 1/2"		9,0 cm/3 1/2"		14,0 cm/5 1/2"		14,0 cm/5 1/2"		14,0 cm/5 1/2"		14,0 cm/5 1/2"	

	AE 670/14		AE 671/14		AE 672/14		AE 673/14		AE 678/18		AE 678/21
									18,0 cm/7"		21,0 cm/8 1/4"
CASTROVIEJO		CASTROVIEJO		CASTROVIEJO		CASTROVIEJO		JACOBSON		JACOBSON	
14,0 cm/5 1/2"		14,0 cm/5 1/2"		14,0 cm/5 1/2"		14,0 cm/5 1/2"		14,0 cm/5 1/2"		14,0 cm/5 1/2"	

breiter Griff
 wide handle
 mango ancho
 manche large
 manico largo

NAHT SUTURE SUTURA SUTURE SUTURA

Mikro-Nadelhalter
 Micro-Needle Holders
 Micro-Porta-agujas
 Micro-Porte-aiguilles
 Micro-Portaghi



AE 680/16
AE 680/18
AE 680/20
AE 680/22

16,5 cm/6¹/₂"
 18,0 cm/7"
 20,0 cm/8"
 22,0 cm/8³/₄"



AE 681/16
AE 681/18
AE 681/20
AE 681/22

AA
 AB
 AC
 AD
AE
 AF
 AG
 AH
 AI
 AJ
 AK
 AL
 AM
 AN
 AO
 AP
 AQ
 AR
 AS
 AT
 AU
 AV
 AW
 AX
 AY
 AZ

AE NAHT SUTURE SUTURA SUTURE SUTURA

Mikro-Nadelhalter
 Micro-Needle-Holders
 Micro-Porta-agujas
 Micro-Porte-aiguilles
 Micro-Portaghi



PATON
AE 684/11
 11,0 cm/4¹/₃"



PATON
AE 685/11
 11,0 cm/4¹/₃"



AE 686/14

AE 687/14

ARRUGA
 14,0 cm/5¹/₂"



KALT
AE 688/14
 14,0 cm/5¹/₂"



KALT-ARRUGA
AE 689/14
 14,0 cm/5¹/₂"



CASTROVIEJO-KALT
AE 690/14
 13,5 cm/5¹/₄"



STEVENS
AE 692/13 **AE 692/15**
 13,0 cm/5" 15,0 cm/6"

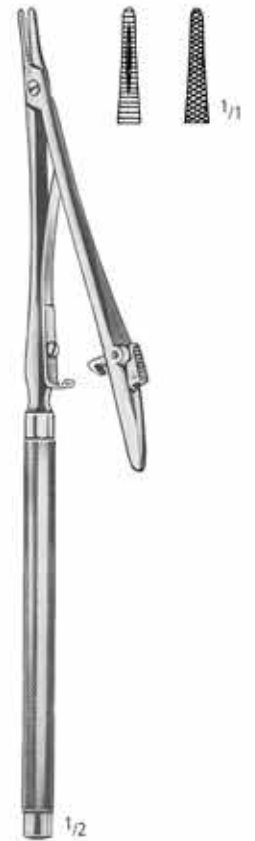

POTTS-SMITH
AE 694/22
 22,0 cm/8³/₄"

NAHT SUTURE SUTURA SUTURE SUTURA

Mikro-Nadelhalter
 Micro-Needle Holders
 Micro-Porta-agujas
 Micro-Porte-aiguilles
 Micro-Portaghi

AA
 AB
 AC
 AD
 AE
 AF
 AK
 AL
 AM
 AO
 AP
 AR
 KA
 KD
 KU
 KY



 1/1
AE 696/01
 1/1
AE 696/02



 1/1
AE 697/01
 1/1
AE 697/02

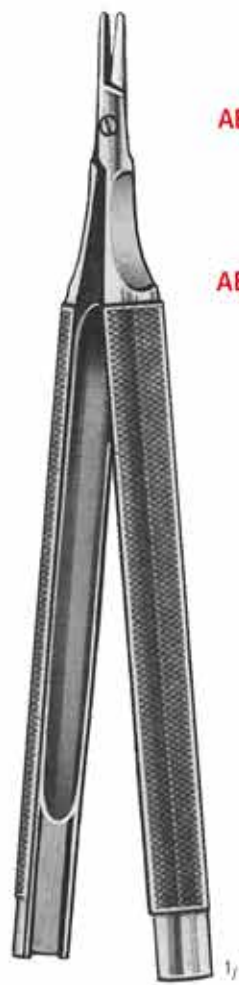

 1/1
AE 698/01
 1/1
AE 698/02

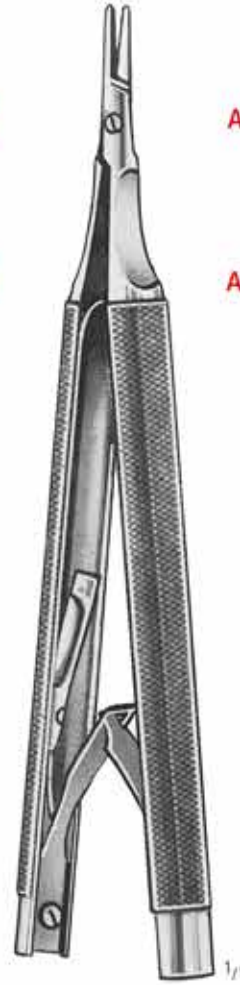

 1/1
AE 699/01
 1/1
AE 699/02

CASTROVIEJO
 13,0 cm/5"

Griff 8 mm Ø
 Handle 8 mm Ø
 Mango 8 mm Ø
 Manche 8 mm Ø
 Manico 8 mm Ø

CASTROVIEJO
 13,0 cm/5"

CASTROVIEJO
 13,0 cm/5"

Griff 10 mm Ø
 Handle 10 mm Ø
 Mango 10 mm Ø
 Manche 10 mm Ø
 Manico 10 mm Ø

CASTROVIEJO
 13,0 cm/5"

AE NAHT SUTURE SUTURA SUTURE SUTURA

Reverdin-Nadeln
 Reverdin Needles
 Agujas de Reverdin
 Aiguilles de Reverdin
 Aghi di Reverdin



1/2

REVERDIN
 14,0 cm/5 1/2"



1/1

Fig. 1

AE 700/01



1/1

2

AE 700/02



1/1

3

AE 700/03



1/1

4

AE 700/04



1/2

REVERDIN
 19,5 cm/7 3/4"
 22,5 cm/9"



1/1

Fig. 1

AE 701/01
AE 702/01



1/1

2

AE 701/02
AE 702/02



1/1

3

AE 701/03
AE 702/03



1/1

4

AE 701/04
AE 702/04

NAHT SUTURE SUTURA SUTURE SUTURA

Unterbindungsnadeln
Ligature Needles
Agujas para ligaduras
Aiguilles à ligatures
Aghi per legatura

DESCHAMPS

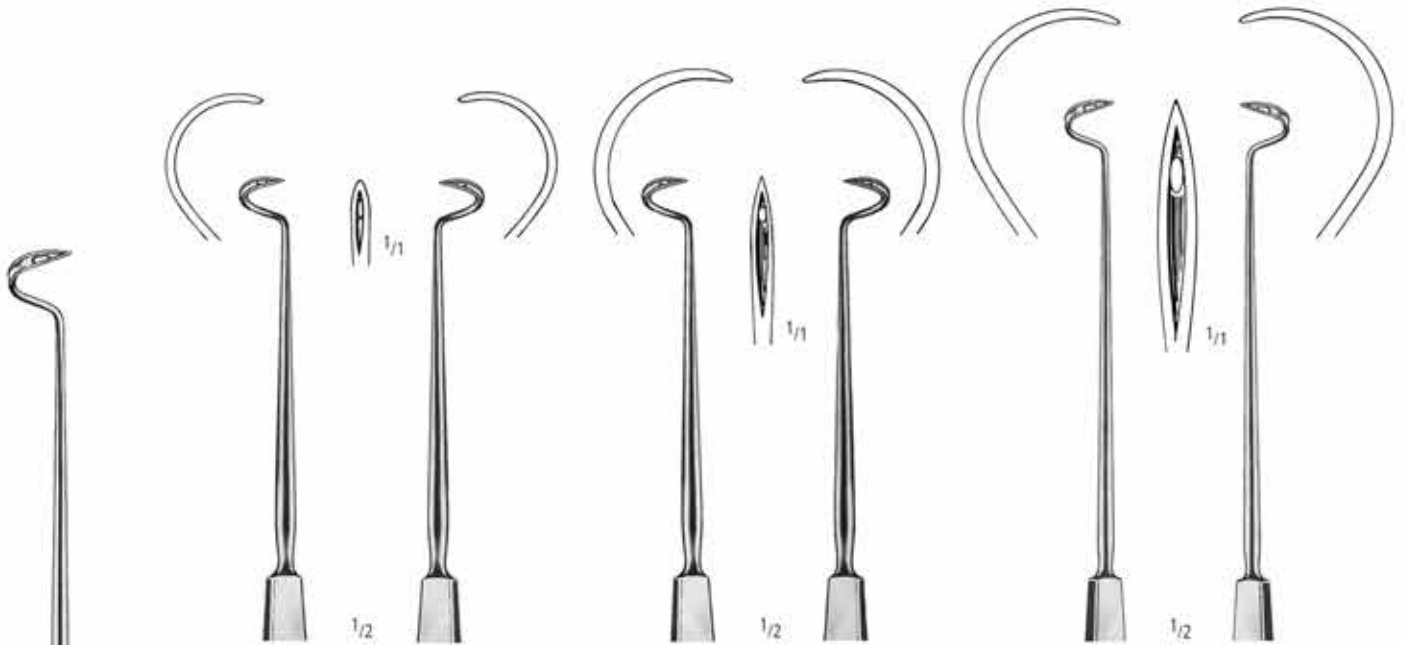

spitz • pointed • agudas • pointues • acuta

20,0 cm/8"	AE 720/20	AE 721/20	AE 722/20	AE 723/20		
21,0 cm/8 ¹ / ₄ "					AE 724/21	AE 725/21
27,0 cm/10 ³ / ₄ "					AE 724/27	AE 725/27

DESCHAMPS

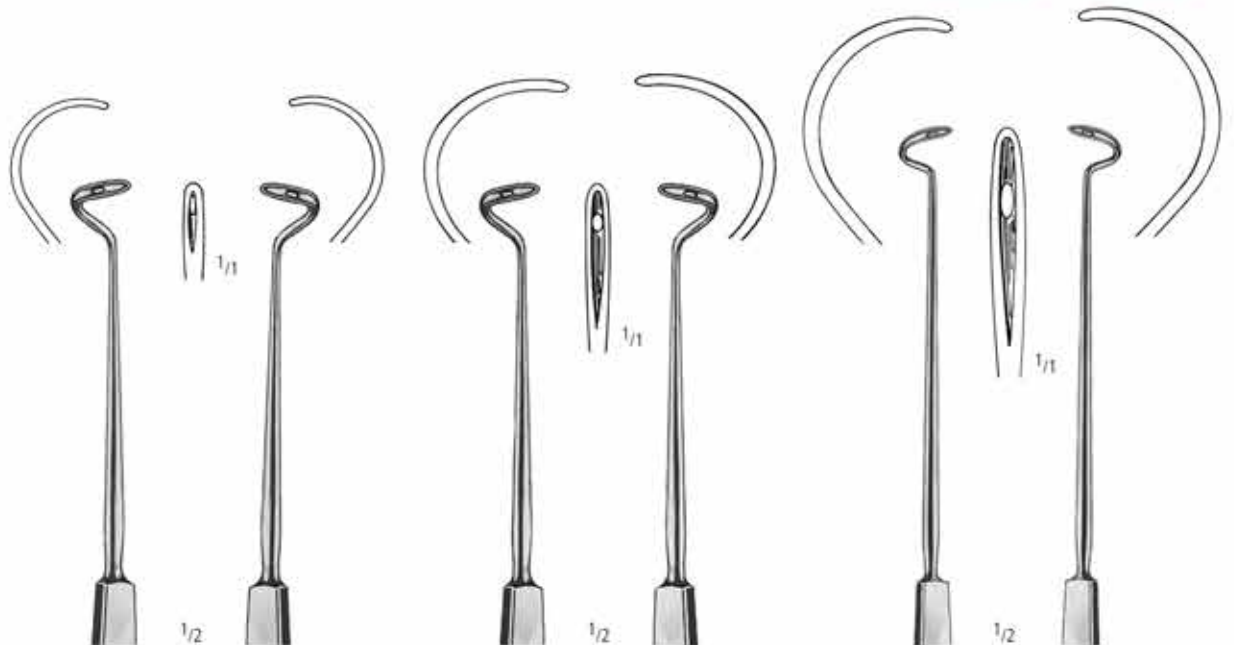

stumpf • blunt • romas • mousses • smussa

20,0 cm/8"	AE 728/20	AE 729/20	AE 730/20	AE 731/20		
21,0 cm/8 ¹ / ₄ "					AE 732/21	AE 733/21
27,0 cm/10 ³ / ₄ "					AE 732/27	AE 733/27

AA
AB
AC
AD
AE
AF
AK
AL
AM
AO
AP
AR
KA
KD
KU
KY

AE NAHT SUTURE SUTURA SUTURE SUTURA

Unterbindungsnadeln
 Ligature Needles
 Agujas para ligaduras
 Aiguilles à ligatures
 Aghi per legatura



AE 750/20
 20,0 cm/8"

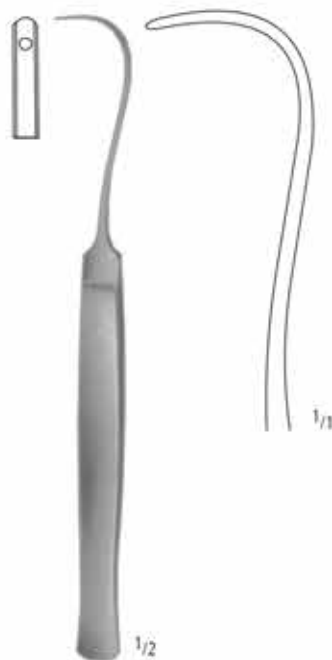

SYME
AE 753/17
 17,0 cm/6³/₄"

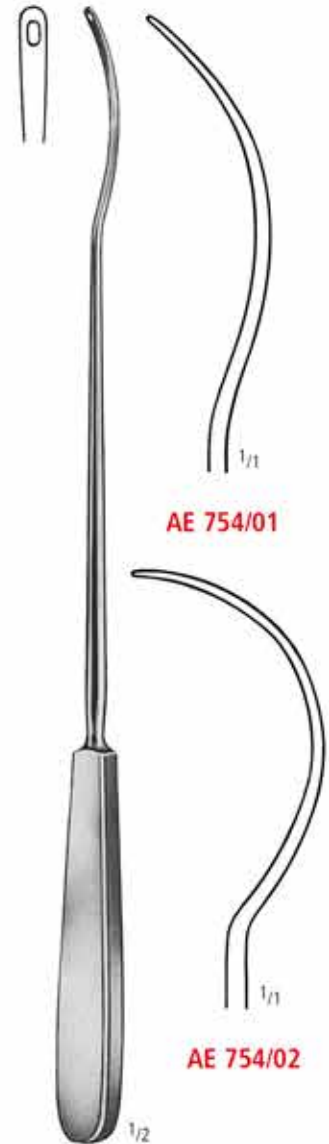

AE 754/01

AE 754/02

BRUNNER
 30,0 cm/12"

NAHT SUTURE SUTURA SUTURE SUTURA

Unterbindungsnadeln
 Ligature Needles
 Aguja para ligaduras
 Aiguilles à ligatures
 Aghi per legatura

AA
 AB
 AC
 AD
 AE
 AF
 AK
 AL
 AM
 AO
 AP
 AR
 KA
 KD
 KU
 KY



BRUNNER
AE 755/25
 25,0 cm/10"



SCHMIEDEN
AE 758/21
 24,0 cm/9 1/2"



DE LA ROZA
AE 767/01
 12,0 cm/4 3/4"



DE LA ROZA
AE 767/02
 12,0 cm/4 3/4"



HESSBERG
AE 768/15
 15,0 cm/6"



JACOBI
AE 769/14
 14,0 cm/5 1/2"

AE NAHT SUTURE SUTURA SUTURE SUTURA

Unterbindungsnadeln
 Ligature Needles
 Agujas para ligaduras
 Aiguilles à ligatures
 Aghi per legatura



KRONECKER
AE 770/01
 15,0 cm/6"



KRONECKER
AE 770/02
 15,0 cm/6"



TRÉLAT
AE 772/23
 23,0 cm/9"



CLAUS
AE 773/23
 23,0 cm/9"



HURD
AE 774/01
 21,0 cm/8 1/4"



HURD
AE 774/02
 21,0 cm/8 1/4"

NAHT SUTURE SUTURA SUTURE SUTURA

Unterbindungsnadeln
Ligature Needles
Agujas para ligaduras
Aiguilles à ligatures
Aghi per legatura



ROTTER
26,0 cm/10¹/₂"

ROTTER
26,0 cm/10¹/₂"

NAGER
AE 777/24
24,0 cm/9¹/₂"

FALK
AE 780/01
24,0 cm/9¹/₂"

FALK
AE 780/02
24,0 cm/9¹/₂"

CLAUS-EICKEN
AE 781/23
23,0 cm/9"

AA
AB
AC
AD
AE
AF
AK
AL
AM
AO
AP
AR
KA
KD
KU
KY

Führungshohlsonden
 Ligature Conductors
 Sondas Conductoras
 Sondes Conductrices
 Sonda conduttrice



BRUNNER
 30,0 cm/12"



AE 800/01



AE 800/02



AE 800/03



AE 800/04



BRUNNER
AE 801/25
 25,0 cm/10"

NAHT SUTURE SUTURA SUTURE SUTURA

Führungshohlsonden
Ligature Conductors
Sondas Conductoras
Sondes Conductrices
Sonde conductrice



PAYR
AE 802/22
22,0 cm/8³/₄"



PAYR
AE 803/22
22,0 cm/8³/₄"

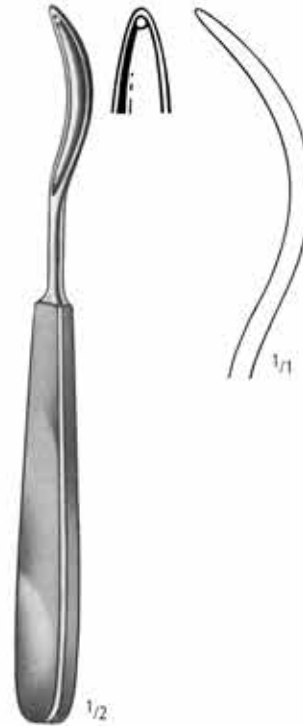

SCHMIEDEN-PAYR
AE 806/19
19,0 cm/7¹/₂"

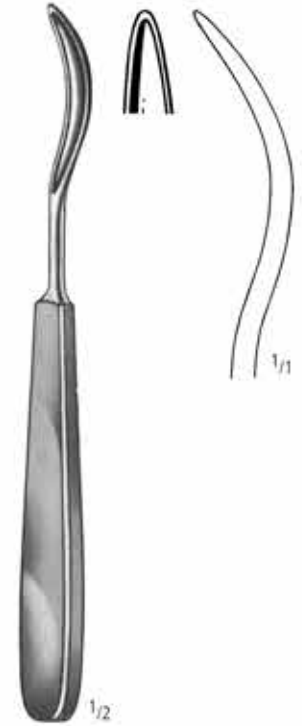

SCHMIEDEN-PAYR
AE 807/19
19,0 cm/7¹/₂"

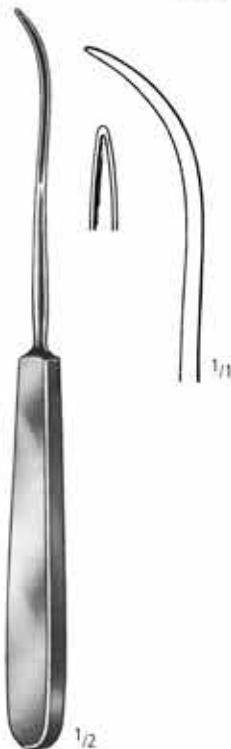

KÖNIG
AE 808/03
19,5 cm/7³/₄"

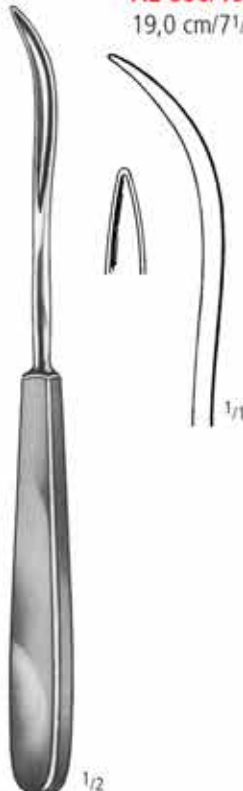

KÖNIG
AE 808/05
19,5 cm/7³/₄"

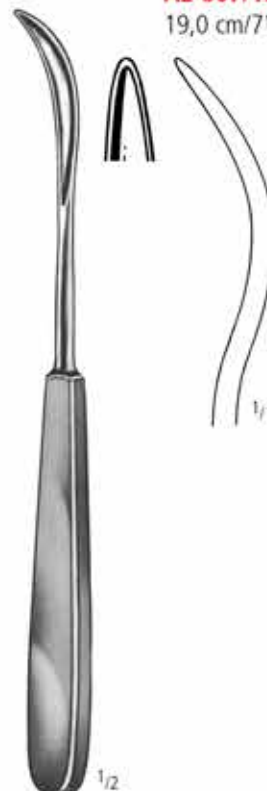

KÖNIG
AE 808/07
19,5 cm/7³/₄"

AA
AB
AC
AD
AE
AF
AG
AH
AI
AJ
AK
AL
AM
AN
AO
AP
AQ
AR
AS
AT
AU
AV
AW
AX
AY
AZ

AE NAHT SUTURE SUTURA SUTURE SUTURA

Führungshohlsonden
Ligature Conductors
Sondas Conductoras
Sondes Conductrices
Sonde conduttrice

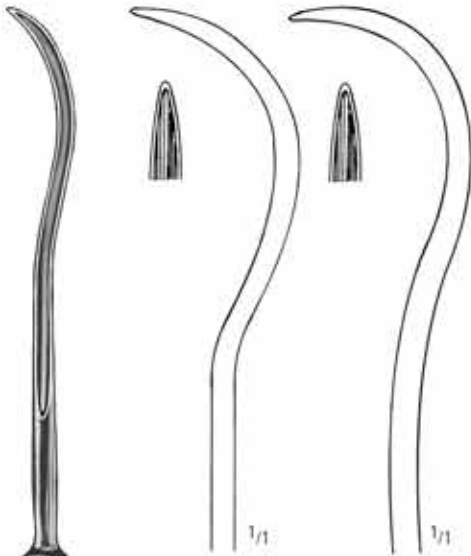

AE 810/25
25,0 cm/10"

AE 811/28
28,0 cm/11"



KOCHER

15,0 cm/6"
16,0 cm/6¹/₄"
18,0 cm/7"

AE 813/15
AE 813/16

AE 814/15
AE 814/16

AE 816/18



KIRSCHNER



FERROZELL
AE 820/24
24,0 cm/9¹/₂"



BRUNNER-FERROZELL
AE 821/18 **AE 821/27**
18,0 cm/7" 27,0 cm/10³/₄"



KIRSCHNER-FERROZELL
AE 822/27
27,0 cm/10³/₄"



FERROZELL
18,0 cm/7"

AE 823/01
gerade
straight
recta
droite
retta

AE 823/02
gebogen
curved
curva
courbe
curva

NAHT SUTURE SUTURA SUTURE SUTURA

Fadenknoter, -fänger, -schlingendreher
 Knot-Tiers, Ligature Catcher, Loop Twisters
 Tuerce-hilos, Porta-ligaduras
 Instruments à noeds, Porte-ligature, Tords-fil
 Strumenti per nodi, Porta-legature, Torcifilo

Nahtpinzetten und Fadenscheren
 finden Sie in den Gruppen AB und AC.

For Suture Forceps and Ligature Scissors
 please refer to groups AB and AC.



AE 830/23
 23,0 cm/9"



BOZEMANN
AE 831/21
 21,0 cm/8¹/₄"



MOD. WIEN
AE 832/23
 23,5 cm/9¹/₃"



FRIEDRICH
AE 833/16
 16,0 cm/6¹/₄"

AA
 AB
 AC
 AD
AE
 AF
 AK
 AL
 AM
 AO
 AP
 AR
 KA
 KD
 KU
 KY

Wundklammerzängchen
Suture Forceps
Pinzas para agrafes
Pincés pour agrafes
Pinze per agrafes



MICHEL
AE 850/12
12,0 cm/4³/₄"



COLLIN
AE 852/13
13,0 cm/5"



RICHTER-HEATH
AE 853/14
14,0 cm/5¹/₂"



WACHENFELDT
AE 855/01
12,5 cm/5"



HEGENBARTH
AE 856/12
12,5 cm/5"



MICHEL
AE 858/12
12,0 cm/4³/₄"

NAHT SUTURE SUTURA SUTURE SUTURA

Wundklammerzängchen, -pinzetten und Wundklammern
 Suture Forceps and Clips
 Pinzas para agrafes y agrafes
 Pincés pour agrafes et agrafes
 Pinze per agrafes ed agrafes



LANGE
AE 859/10
 10,0 cm/4"



CHILDE
AE 860/01
 18,0 cm/7"



CHILDE
AE 860/02
 18,0 cm/7"

Verkaufseinheit: 1000 Stück
 Unit for Sale: 1000 each
 Unidad de venta: 1000 piezas
 Unité de vente: 1000 pièces
 Unità di vendita: 1000 pezzi

Größen
 sizes
 tamaños
 dimensions
 dimensioni



MICHEL

Artikel Nr.	mm	
AE 870/08	7,5 x 1,75	
AE 870/11	11 x 2,5	
AE 870/12	12 x 3	
AE 870/14	14 x 3	
AE 870/16	16 x 3	
AE 870/18	18 x 3	
AE 870/20	20 x 3	

1/1

AA
 AB
 AC
 AD
AE
 AF
 AG
 AH
 AI
 AJ
 AK
 AL
 AM
 AN
 AO
 AP
 AQ
 AR
 AS
 AT
 AU
 AV
 AW
 AX
 AY
 AZ

TUPFERZANGEN
SPONGE FORCEPS
PINZAS PARA POLIPOS
PINCES A PANSEMENTS
PINZE PER POLIPI

AF

nopa[®] instruments



Schwammzangen
Sponge Holding Forceps
Pinzas para esponjas
Pinces à éponges
Pinze per spugne



BRYANT
AF 040/13
13,0 cm/5"



LISTER
13,0 cm/5" **AF 050/13**
16,0 cm/6¹/₄" **AF 050/16**
18,0 cm/7" **AF 050/18**

AF 050/16

Korn- und Tupferzangen, Schwammzangen
 Polypus and Dressing Forceps, Sponge Holding Forceps
 Pinzas para pólipos, tapones y esponjas
 Pincas à pansements, à tampons et à éponges
 Pinze per polipi, tamponi e spugne

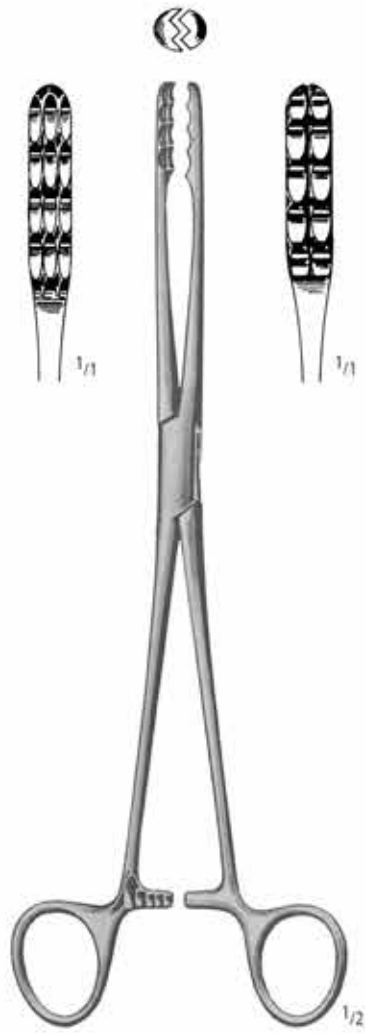

ULRICH
AF 070/22
AF 070/25
AF 070/27

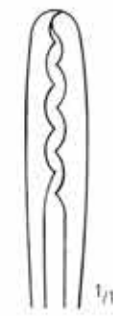

22,0 cm/8³/₄"
 25,0 cm/10"
 27,0 cm/10³/₄"

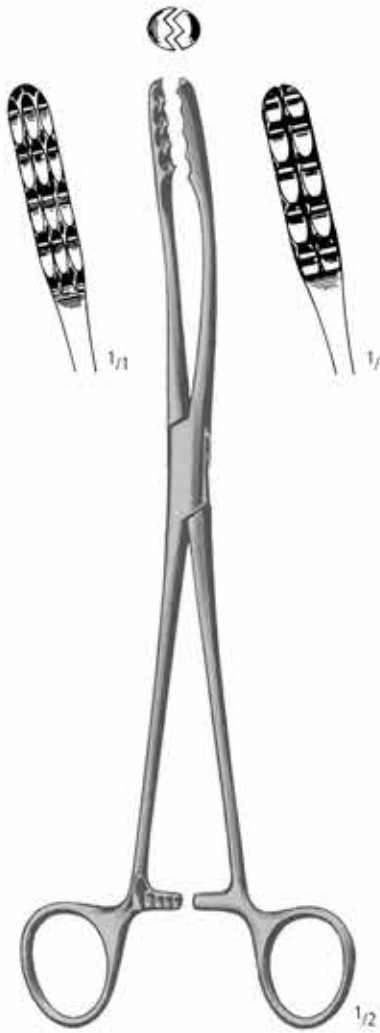

ULRICH
AF 071/22
AF 071/25
AF 071/27

AA
 AB
 AC
 AD
 AE
AF
 AK
 AL
 AM
 AO
 AP
 AR
 KA
 KD
 KU
 KY

Korn- und Tupferzangen, Schwammzangen
 Polypus and Dressing Forceps, Sponge Holding Forceps
 Pinzas para pólipos, tapones y esponjas
 Pincés à pansements, à tampons et à éponges
 Pinze per polipi, tamponi e spugne



GROSS-MAIER

- AF 100/20**
- AF 100/22**
- AF 100/25**
- AF 100/27**

- 20,0 cm/8"
- 22,0 cm/8³/₄"
- 25,0 cm/10"
- 27,0 cm/10³/₄"



GROSS-MAIER

- AF 101/20**
- AF 101/22**
- AF 101/25**
- AF 101/27**

Korn- und Tupferzangen, Schwammzangen
 Polypus and Dressing Forceps, Sponge Holding Forceps
 Pinzas para pólipos, tapones y esponjas
 Pincas à pansements, à tampons et à éponges
 Pinze per polipi, tamponi e spugne

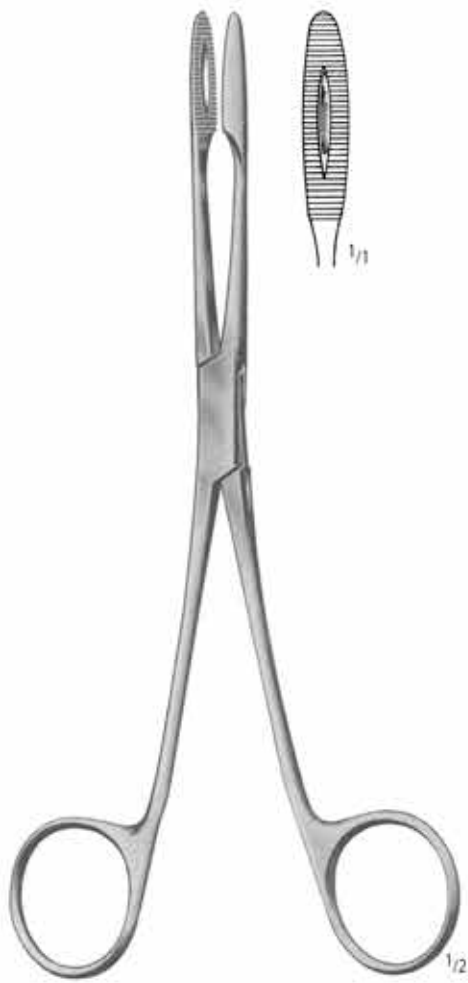

GROSS-MAIER

- AF 102/20
- AF 102/22
- AF 102/25
- AF 102/27

- 20,0 cm/8"
- 22,0 cm/8³/₄"
- 25,0 cm/10"
- 27,0 cm/10³/₄"

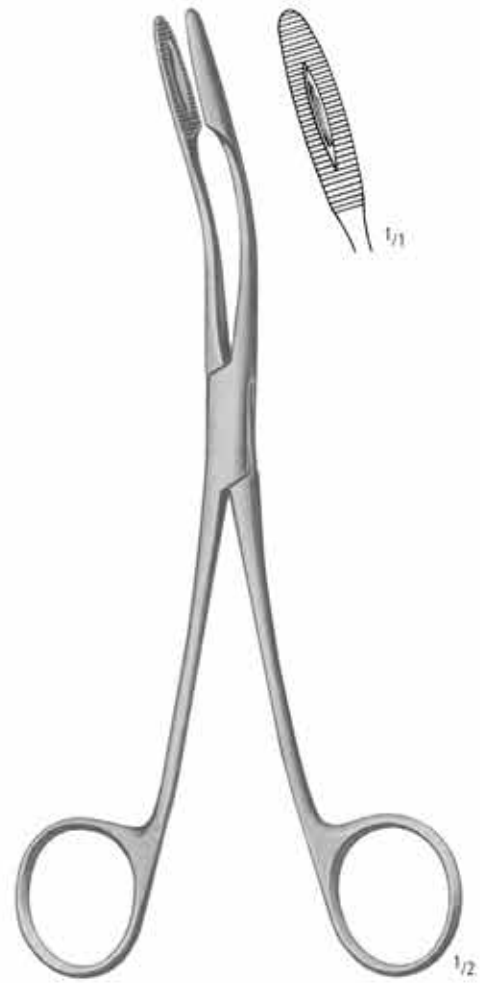

GROSS-MAIER

- AF 103/20
- AF 103/22
- AF 103/25
- AF 103/27

AA
AB
AC
AD
AE
AF
AK
AL
AM
AO
AP
AR
KA
KD
KU
KY

Korn- und Tupferzangen, Schwammzangen
 Polypus and Dressing Forceps, Sponge Holding Forceps
 Pinzas para pólipos, tapones y esponjas
 Pincés à pansements, à tampons et à éponges
 Pinze per polipi, tamponi e spugne



FLETCHER
AF 120/24
 24,0 cm/9¹/₂"



FLETCHER
AF 123/24
 24,0 cm/9¹/₂"

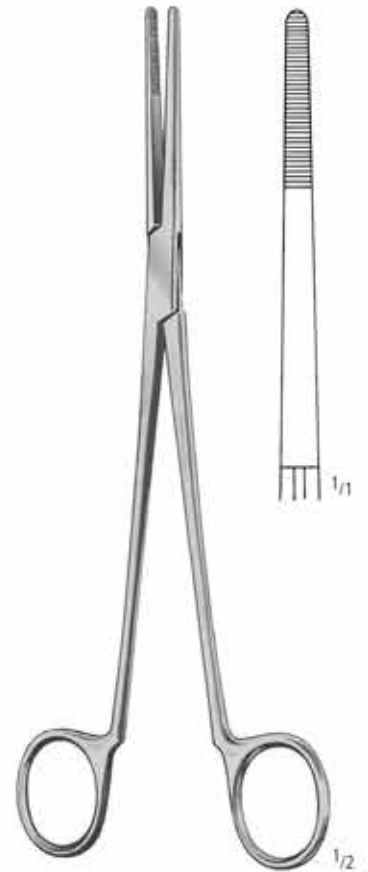

WESTERMARK
AF 130/23
 23,0 cm/9"

Korn- und Tupferzangen, Schwammzangen
 Polypus and Dressing Forceps, Sponge Holding Forceps
 Pinzas para pólipos, tapones y esponjas
 Pincas à pansements, à tampons et à éponges
 Pinze per polipi, tamponi e spugne



BOZEMANN
AF 132/26
 26,0 cm/10¹/₂"

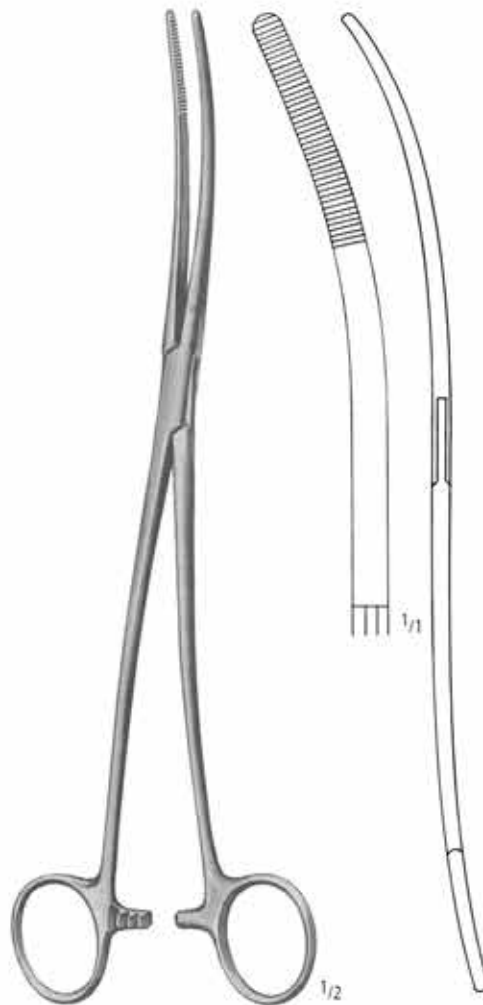

BOZEMANN
AF 135/26
 26,0 cm/10¹/₂"

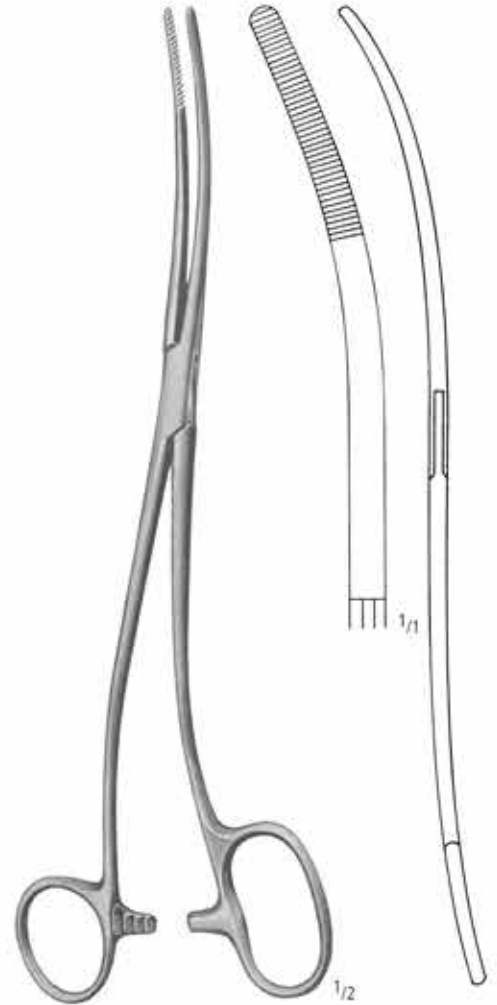

BOZEMANN-DOUGLAS
AF 137/26
 26,0 cm/10¹/₂"

AA
 AB
 AC
 AD
 AE
AF
 AK
 AL
 AM
 AO
 AP
 AR
 KA
 KD
 KU
 KY

Korn- und Tupferzangen, Schwammzangen
 Polypus and Dressing Forceps, Sponge Holding Forceps
 Pinzas para pólipos, tapones y esponjas
 Pincers à pansements, à tampons et à éponges
 Pinze per polipi, tamponi e spugne



CHERON
AF 141/25
 25,0 cm/10"



COLLIN
AF 144/24
 24,0 cm/9 1/2"



NOTO
AF 146/28
 27,5 cm/10 3/4"

Korn- und Tupferzangen, Schwammzangen
 Polypus and Dressing Forceps, Sponge Holding Forceps
 Pinzas para pólipos, tapones y esponjas
 Pincas à pansements, à tampons et à éponges
 Pinze per polipi, tamponi e spugne



PELKMANN
AF 154/25
 25,0 cm/10"



PELKMANN
AF 155/25
 25,0 cm/10"



KELLY
AF 161/32
 32,0 cm/12³/₄"

AA
 AB
 AC
 AD
 AE
AF
 AK
 AL
 AM
 AO
 AP
 AR
 KA
 KD
 KU
 KY

Korn- und Tupferzangen, Schwammzangen
 Polypus and Dressing Forceps, Sponge Holding Forceps
 Pinzas para pólipos, tapones y esponjas
 Pincès à pansements, à tampons et à éponges
 Pinze per polipi, tamponi e spugne

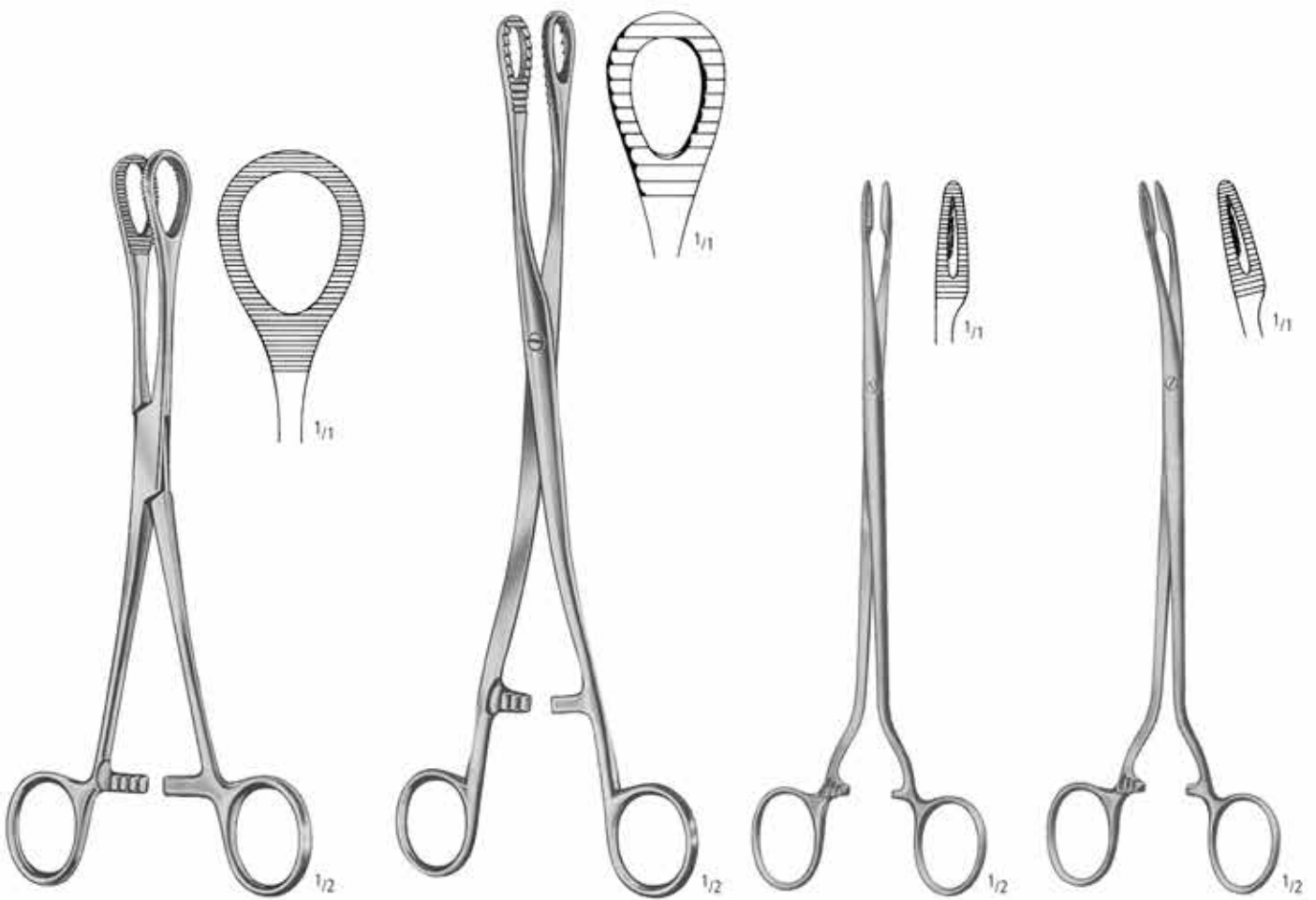

HEYWOOD-SMITH
AF 170/21
 21,0 cm/8¹/₄"

HEYWOOD-SMITH
AF 172/25
 25,0 cm/10"

DUPLAY
AF 176/20
 20,5 cm/8"

DUPLAY
AF 177/20
 20,5 cm/8"

Korn- und Tupferzangen, Schwammzangen
 Polypus and Dressing Forceps, Sponge Holding Forceps
 Pinzas para pólipos, tapones y esponjas
 Pincas à pansements, à tampons et à éponges
 Pinze per polipi, tamponi e spugne



FOERSTER-BALLENGER



AF 200/18 18,0 cm/7"
AF 200/20 20,0 cm/8"

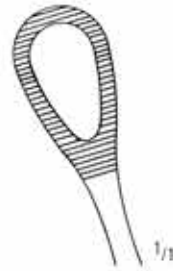

AF 201/18
AF 201/20



AF 200/36 36,0 cm/14"

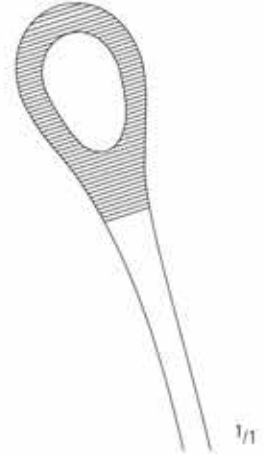

AF 201/36



AF 202/18 18,0 cm/7"
AF 202/20 20,0 cm/8"



AF 203/18
AF 203/20



FOERSTER-BALLENGER

25,0 cm/10"



AF 200/25



AF 201/25



AF 202/25



AF 203/25

AA
 AB
 AC
 AD
 AE
AF
 AK
 AL
 AM
 AO
 AP
 AR
 KA
 KD
 KU
 KY

Korn- und Tupferzangen, Schwammzangen
 Polypus and Dressing Forceps, Sponge Holding Forceps
 Pinzas para pólipos, tapones y esponjas
 Pincas à pansements, à tampons et à éponges
 Pinze per polipi, tamponi e spugne

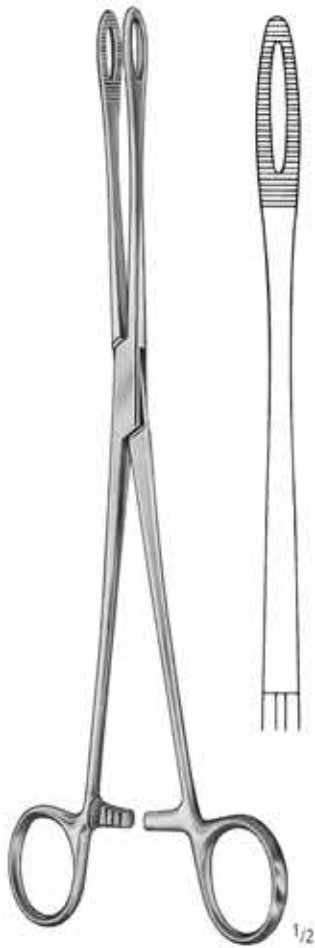

FOERSTER
 25,0 cm/10"

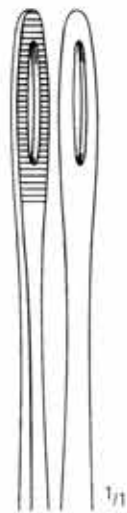

AF 210/25

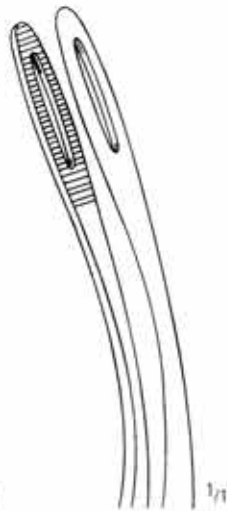

AF 211/25



RAMPLEY

AF 216/18
 18,0 cm/7"

AF 216/25
 25,0 cm/10"

TUPFERZANGEN SPONGE FORCEPS PINZAS PARA POLIPOS PINCES A PANSEMENTS PINZE PER POLIPI

Korn- und Tupferzangen, Schwammzangen
 Polypus and Dressing Forceps, Sponge Holding Forceps
 Pinzas para pólipos, tapones y esponjas
 Pincas à pansements, à tampons et à éponges
 Pinze per polipi, tamponi e spugne

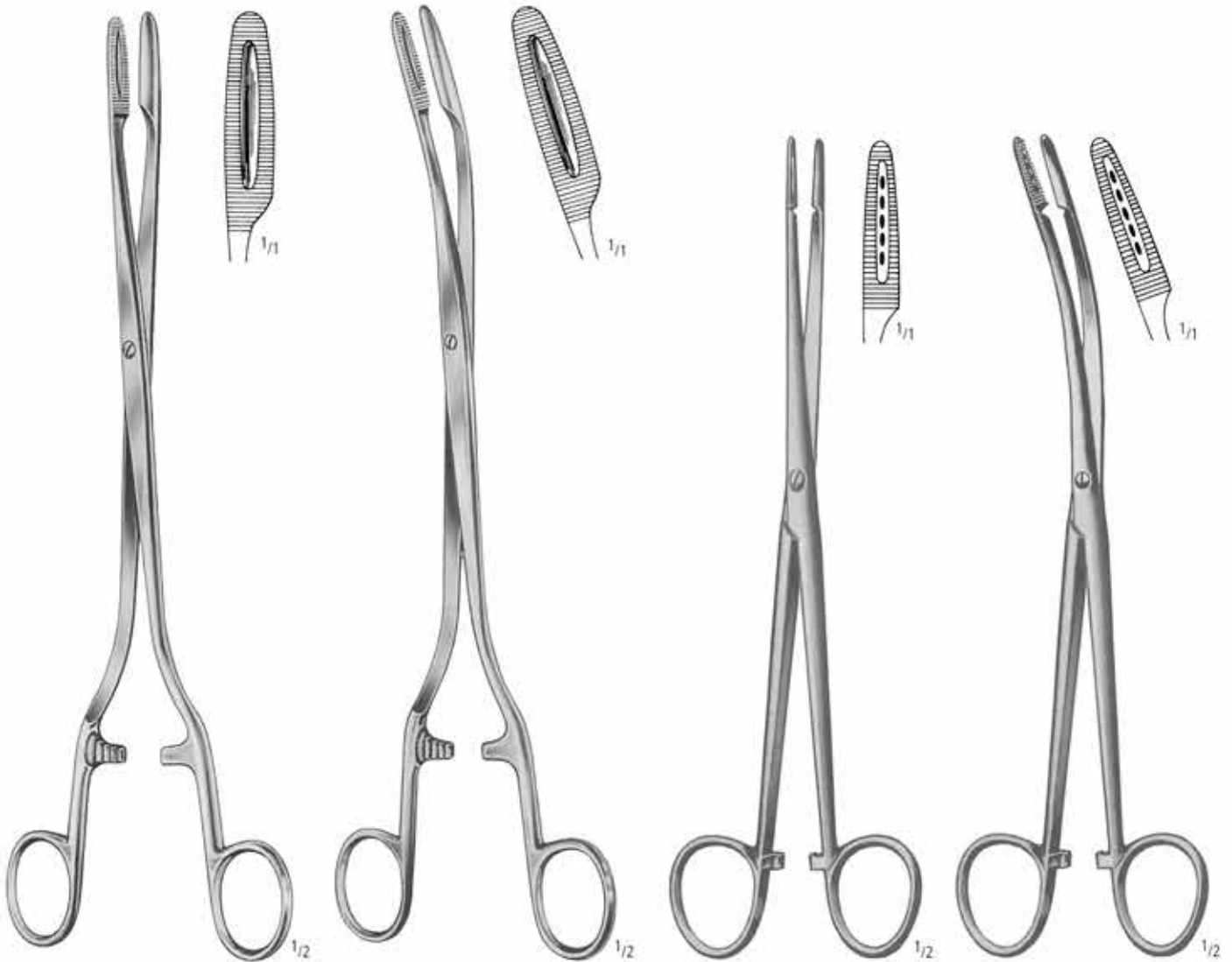

SIMS-MAIER
AF 222/28
 28,0 cm/11"

SIMS-MAIER
AF 223/28
 28,0 cm/11"

AF 226/17
AF 226/25

WALTON
 17,0 cm/6³/₄"
 25,5 cm/10"

AF 227/17
AF 227/25

AA
 AB
 AC
 AD
 AE
AF
 AG
 AH
 AI
 AJ
 AK
 AL
 AM
 AN
 AO
 AP
 AQ
 AR
 AS
 AT
 AU
 AV
 AW
 AX
 AY
 AZ

WUNDHAKEN
RETRACTORS
SEPARADORES
ECARTEURS
DIVARICATORI

AK

nopa[®] instruments



Feine Wundhaken
 Delicate Hooks
 Ganchos
 Crochets très fins
 Divaricatori sottili



GILLIES
AK 020/01
 18,0 cm/7"



GILLIES
AK 020/02
 18,0 cm/7"



KILNER
AK 022/15
 15,0 cm/6"



FRAZIER
AK 024/13
 13,0 cm/5"



AK 026/01



KLEINERT-KUTZ
AK 026/02
 16,0 cm/6¹/₄"



AK 026/03

Feine Wundhaken
Delicate Hooks
Ganchos
Crochets très fins
Divaricatori sottili

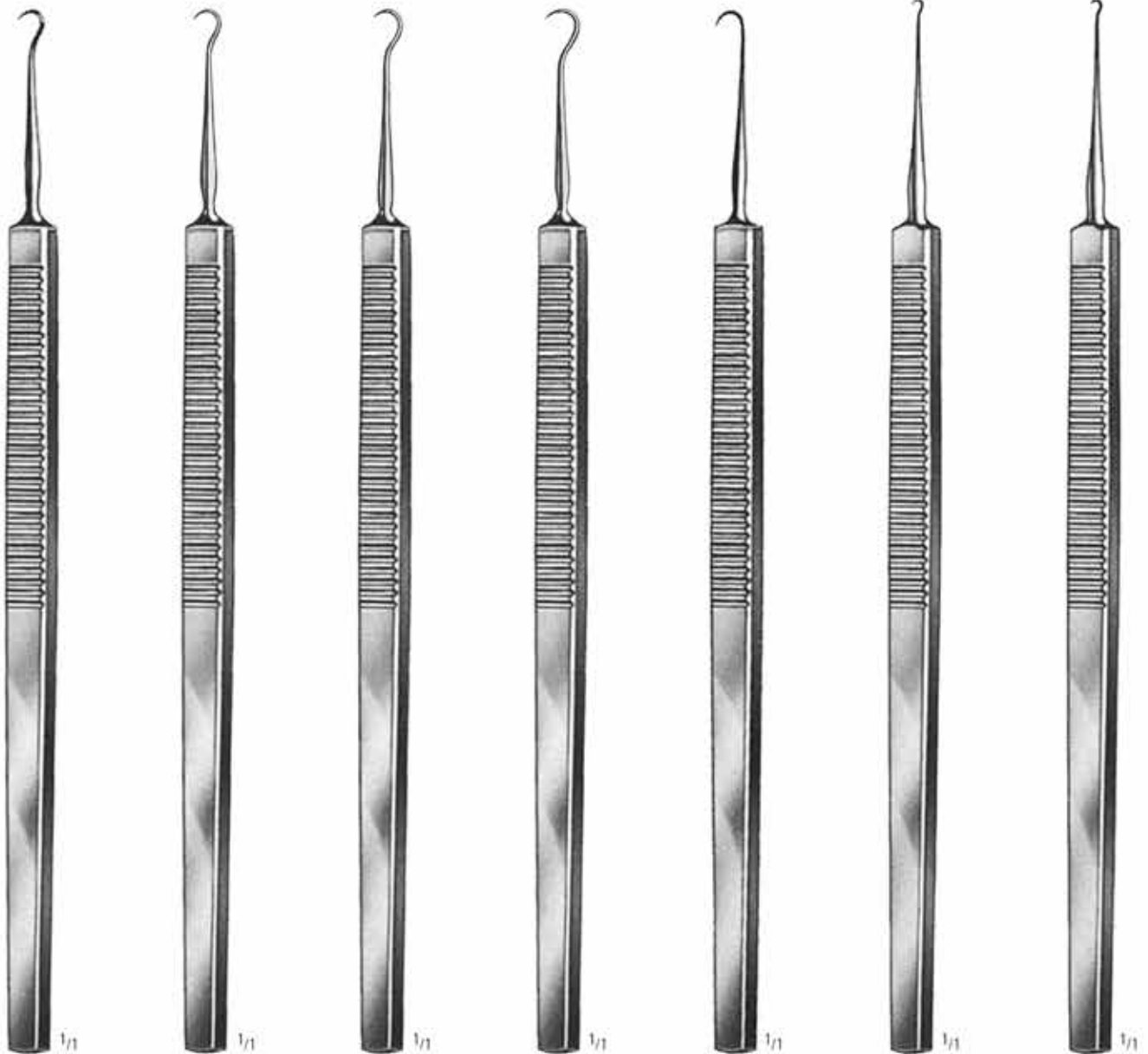

AK 028/01
16,0 cm/6¹/₄"

AK 028/02
16,0 cm/6¹/₄"

AK 028/03
16,0 cm/6¹/₄"

AK 028/04
16,0 cm/6¹/₄"

O' CONNOR
AK 030/16
16,0 cm/6¹/₄"

GRAEFE
AK 032/01
16,0 cm/6¹/₄"

GRAEFE
AK 032/02
16,0 cm/6¹/₄"

AA
AB
AC
AD
AE
AF
AK
AL
AM
AO
AP
AR
KA
KD
KU
KY

AK WUNDHAKEN RETRACTORS SEPARADORES ECARTEURS DIVARICATORI

Feine Wundhaken
Delicate Hooks
Ganchos
Crochets très fins
Divaricatori sottili



CUSHING
28,0 cm/11"



AK 034/01



AK 034/02



CUSHING
19,0 cm/7 1/2"



AK 036/01



AK 036/02



MOLDESTAD
AK 038/13
13,0 cm/5"



AK 040/05
5 mm



AK 040/07
7 mm

17,0 cm/6 3/4"



AK 042/10
Ø 1,0 mm



AK 042/12
Ø 1,2 mm



18,5 cm/7 1/8"

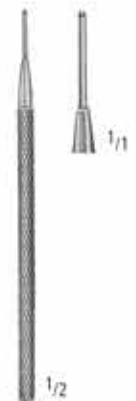

AK 044/11
11,0 cm/4 1/8"

WUNDHAKEN RETRACTORS SEPARADORES ECARTEURS DIVARICATORI

Feine Wundhaken
Delicate Hooks
Ganchos
Crochets très fins
Divaricatori sottili



AK 050/01



AK 051/01



AK 052/01



AK 050/02



AK 051/02



AK 052/02



AK 050/03



AK 051/03



AK 052/03



AK 050/04



AK 051/04



AK 052/04



AK 060/01



AK 062/01



AK 060/02



AK 062/02



AK 060/03



AK 062/03



AK 060/04



AK 062/04

AA
AB
AC
AD
AE
AF
AK
AL
AM
AO
AP
AR
KA
KD
KU
KY

AK WUNDHAKEN RETRACTORS SEPARADORES ECARTEURS DIVARICATORI

Feine Wundhaken
Delicate Hooks
Ganchos
Crochets très fins
Divaricatori sottili

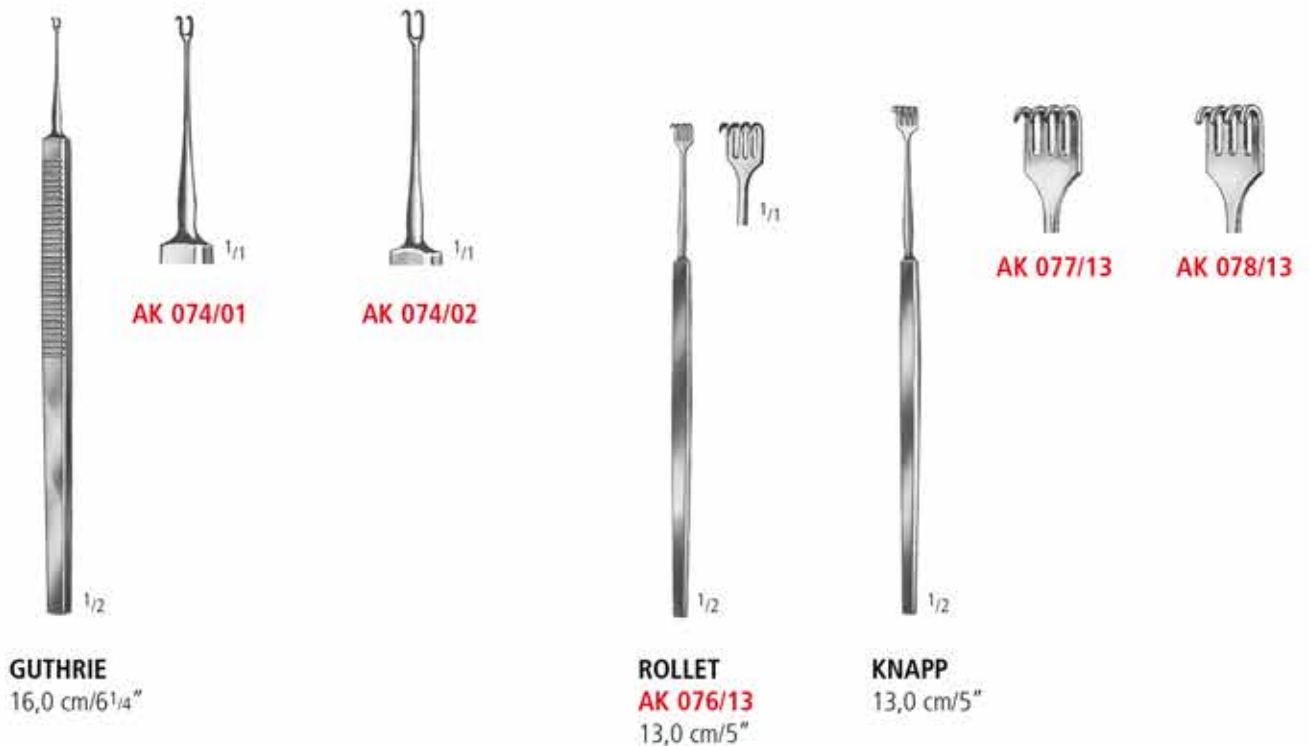
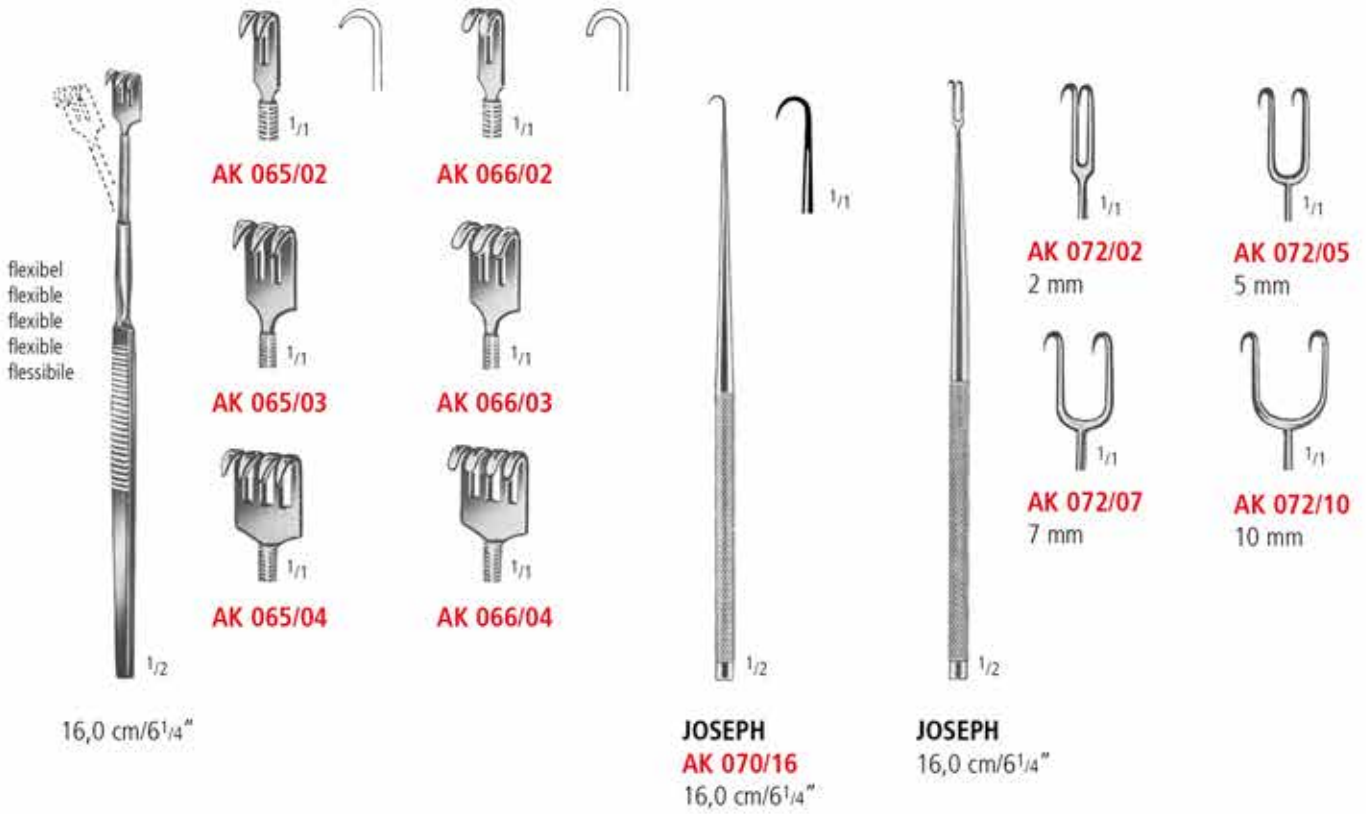

WUNDHAKEN RETRACTORS SEPARADORES ECARTEURS DIVARICATORI

Feine Wundhaken
Delicate Hooks
Ganchos
Crochets très fins
Divaricatori sottili



MEYERDING
18,0 cm/7"



AK 080/01
18 x 7 mm



AK 080/02
16 x 5 mm



AK 080/03
7 x 4 mm



AK 080/04
10 x 3 mm



AK 080/05
7 x 4 mm



AK 080/06
4 x 10 mm



SENN-GREEN
15,0 cm/6"



AK 082/10
10 x 6 mm



AK 082/20
20 x 6 mm



MINI-LANGENBECK
16,0 cm/6 1/4"



AK 086/10
10 x 6 mm



AK 086/17
17 x 5 mm



AK 086/20
20 x 6 mm



AK 086/22
22 x 8 mm

AA
AB
AC
AD
AE
AF
AK
AL
AM
AO
AP
AR
KA
KD
KU
KY

AK WUNDHAKEN RETRACTORS SEPARADORES ECARTEURS DIVARICATORI

Feine Wundhaken
Delicate Hooks
Ganchos
Crochets très fins
Divaricatori sottili



DESMARRES
13,0 cm/5"



DESMARRES
16,0 cm/6 1/4"



CUSHING
20,0 cm/8"



CUSHING
24,0 cm/9 1/2"

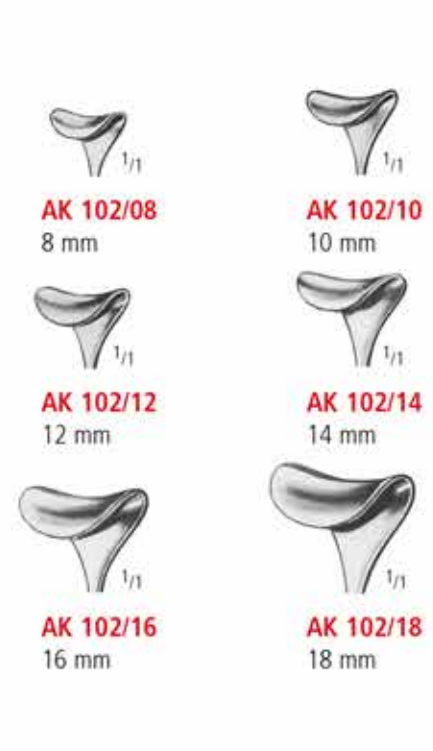

WUNDHAKEN RETRACTORS SEPARADORES ECARTEURS DIVARICATORI

Feine Wundhaken
Delicate Hooks
Ganchos
Crochets très fins
Divaricatori sottili



AA
AB
AC
AD
AE
AF
AK
AL
AM
AO
AP
AR
KA
KD
KU
KY

AK WUNDHAKEN RETRACTORS SEPARADORES ECARTEURS DIVARICATORI

Feine Wundhaken, Spinalhaken
 Delicate Retractors, Spinal Retractors
 Separadores finas, Separadores espinales
 Ecarteurs fins, Ecarteurs spinals
 Divaricatori sottili, Divaricatori spinali



AK 120/15

AK 121/15

BABY-SENN-MILLER
 15,0 cm/6"



AK 122/16

AK 123/16

SENN-MILLER
 16,0 cm/6¹/₄"



RAGNELL-DAVIS
AK 125/14
 14,0 cm/5¹/₂"

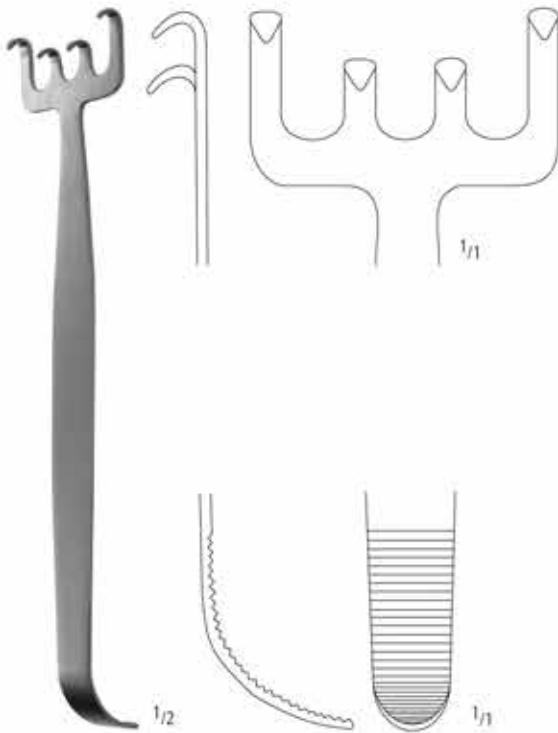

WALTER
AK 128/19
 19,0 cm/7¹/₂"



CUSHING
AK 130/20
 20,0 cm/8"

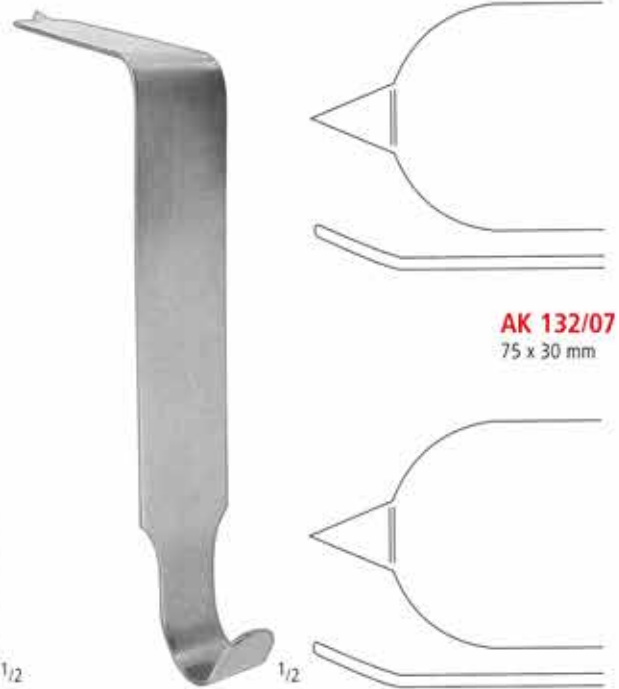

TAYLOR
 16,5 cm/6¹/₂"

AK 132/07
 75 x 30 mm

AK 132/10
 100 x 30 mm

AA
AB
AC
AD
AE
AF
AK
AL
AM
AO
AP
AR
KA
KD
KY



VOLKMANN
21,5 cm/8¹/₂"

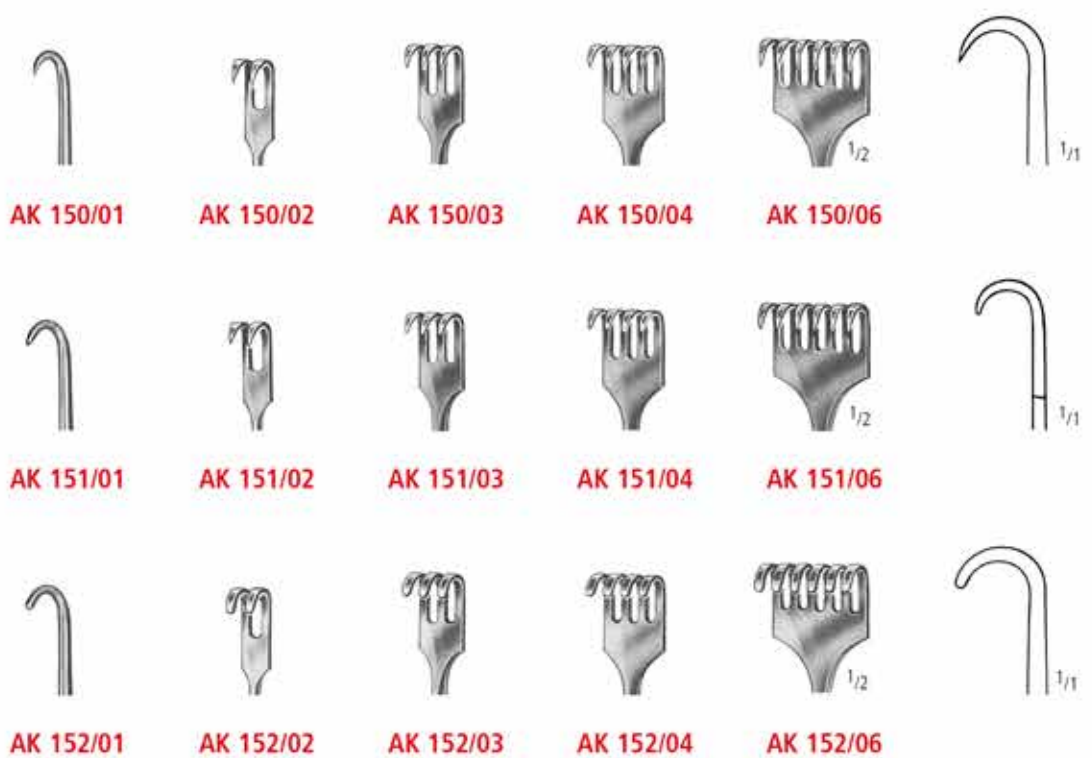

KOCHER
22,0 cm/8³/₄"

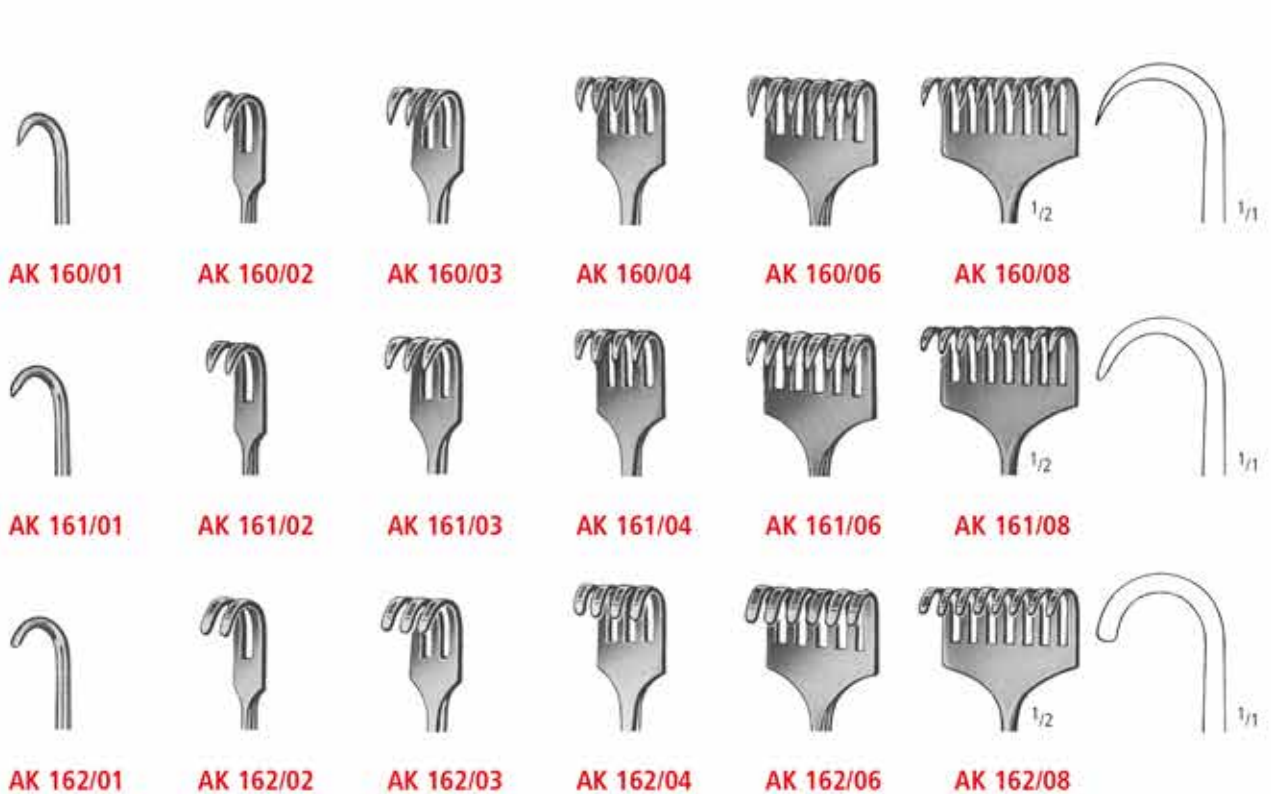



AK 170/21



AK 171/21

VOLKMANN
21,5 cm/8 1/2"

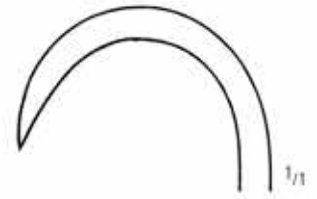

AK 172/20
20,0 cm/8"

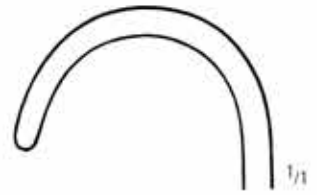

AK 173/20
20,0 cm/8"



AK 180/08
26 x 40 mm



AK 181/08
26 x 40 mm

KOERTE
24,0 cm/9 1/2"



AK 185/35
35 x 40 mm



AK 185/43
43 x 35 mm



AK 185/45
45 x 50 mm

BILLROTH
25,0 cm/10"



AK 200/30
36 x 30 mm

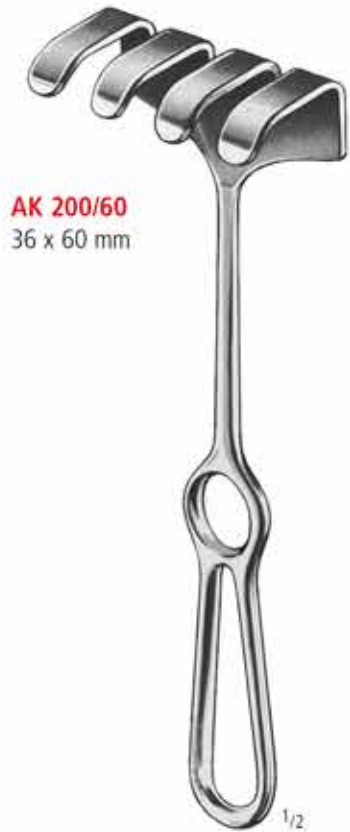

AK 200/60
36 x 60 mm

OLLIER
22,5 cm/9"



ISRAEL
25,0 cm/10"



AK 210/40
40 x 40 mm

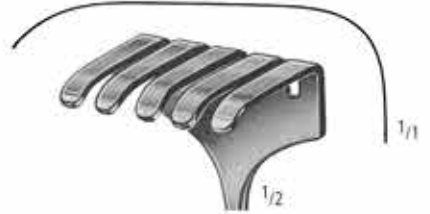

AK 210/50
45 x 50 mm

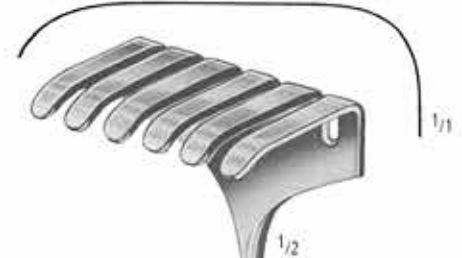

AK 210/60
50 x 60 mm

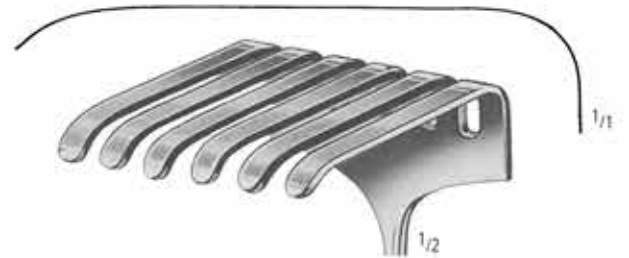

AK 210/70
70 x 70 mm

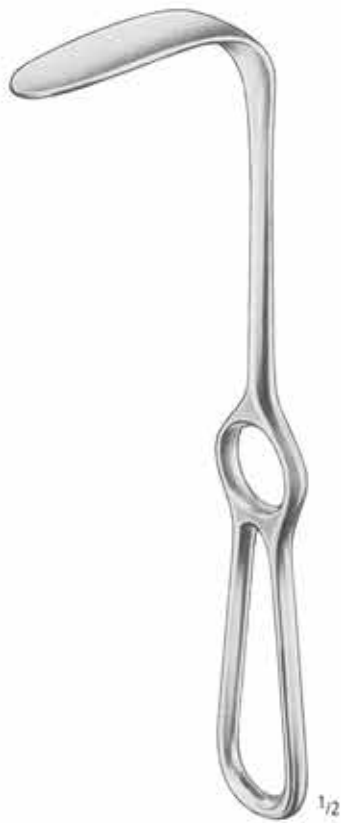

LANGENBECK
21,0 cm/8¹/₄"

¹/₂

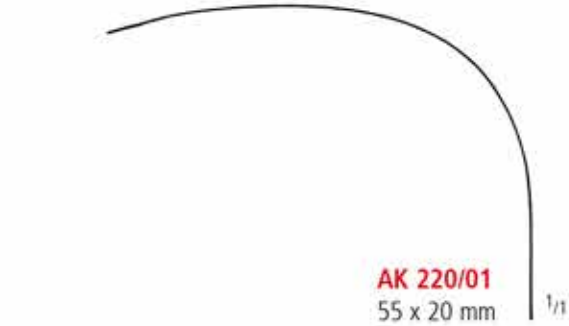

AK 220/01
55 x 20 mm

¹/₁

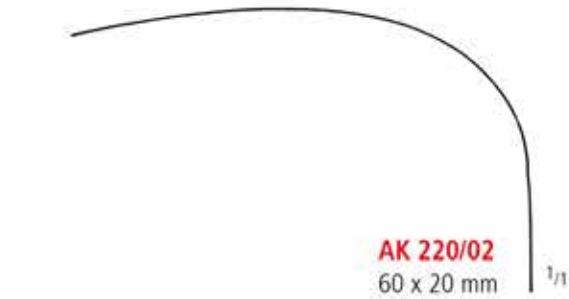

AK 220/02
60 x 20 mm

¹/₁

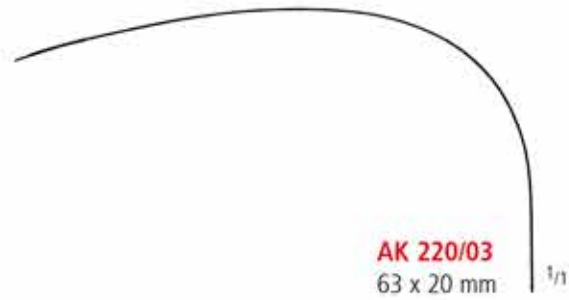

AK 220/03
63 x 20 mm

¹/₁

WUNDHAKEN RETRACTORS SEPARADORES ECARTEURS DIVARICATORI

Weichteilhaken
Soft tissue retractors
Separadores para partes blandas
Ecarteurs pour parties molles
Divaricatori per tessuti molli



OBWEGESER
24,0 cm/9 1/2"



AA
AB
AC
AD
AE
AF
AK
AL
AM
AO
AP
AR
KA
KD
KU
KY

Weichteilhaken
Soft tissue retractors
Separadores para partes blandas
Ecarteurs pour parties molles
Divaricatori per tessuti molli



OBWEGESER
24,0 cm/9¹/₂"



AK 223/01
5 x 16 mm



AK 223/02
7 x 25 mm



AK 223/03
10 x 35 mm



AK 223/04
10 x 42 mm



AK 223/05
12 x 55 mm



AK 223/06
14 x 70 mm



AK 223/07
16 x 80 mm

WUNDHAKEN RETRACTORS SEPARADORES ECARTEURS DIVARICATORI

Ramushaken
 Ramus retractors
 Separadores para el ramo
 Ecarteurs pour ramus
 Divaricatori per ramo

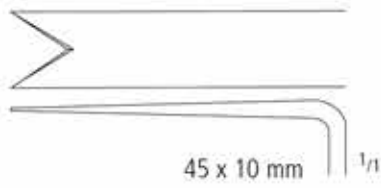

OBWEGESER
AK 225/01
 22,0 cm/8³/₄"



OBWEGESER
AK 225/02
 24,0 cm/9¹/₂"

AA
 AB
 AC
 AD
 AE
 AF
AK
 AL
 AM
 AO
 AP
 AR
 KA
 KD
 KU
 KY



LANGENBECK
AK 230/01-05
 22,0 cm/8³/₄"



AK 230/01
AK 231/01
 30 x 11 mm



AK 230/02
AK 231/02
 30 x 14 mm



AK 230/03
AK 231/03
 30 x 16 mm



AK 230/04
AK 231/04
 40 x 11 mm



AK 230/05
AK 231/05
 50 x 11 mm



LANGENBECK
AK 231/01-05
 22,0 cm/8³/₄"



AK 233/01
25 x 6 mm



AK 233/02
35 x 8 mm



AK 233/03
35 x 11 mm



AK 233/04
35 x 15 mm



AK 233/05
40 x 11 mm



AK 233/06
55 x 11 mm



AK 233/07
70 x 14 mm



AK 233/08
80 x 12 mm



AK 233/09
80 x 16 mm



KOCHER-LANGENBECK
21,5 cm/8 1/2"

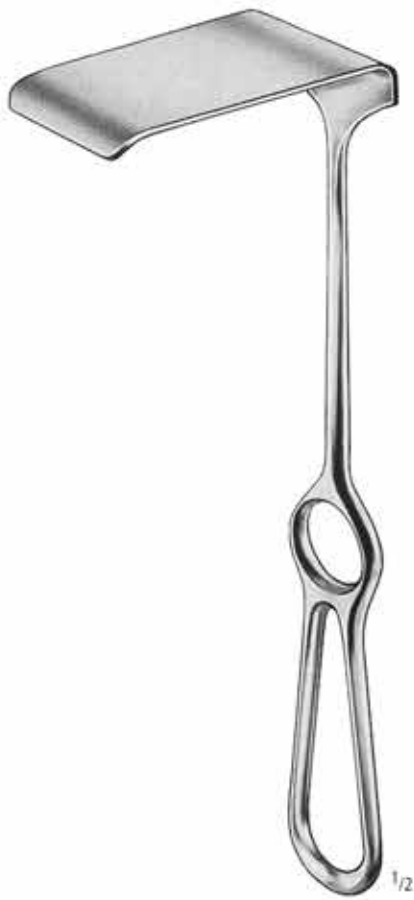

KOCHER
23,0 cm/9"

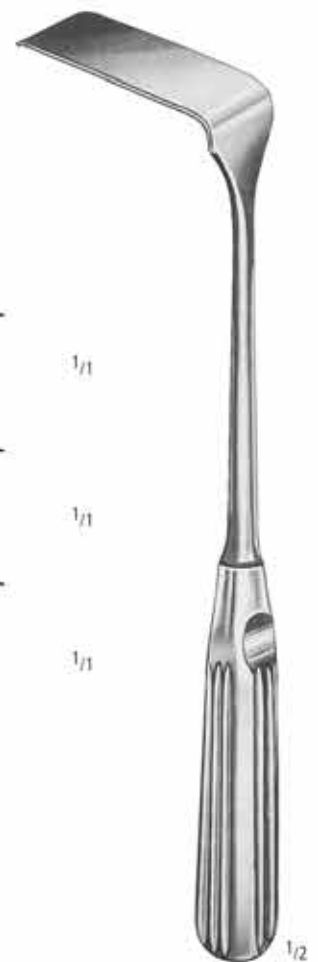
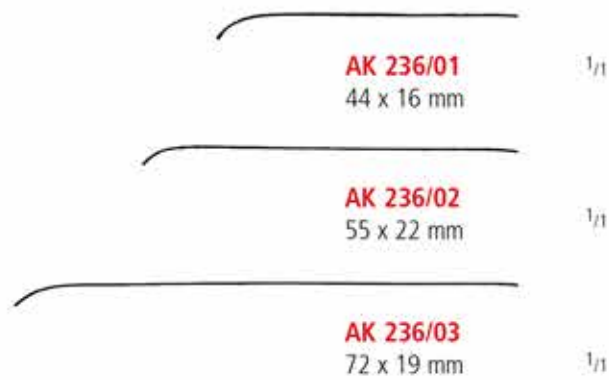
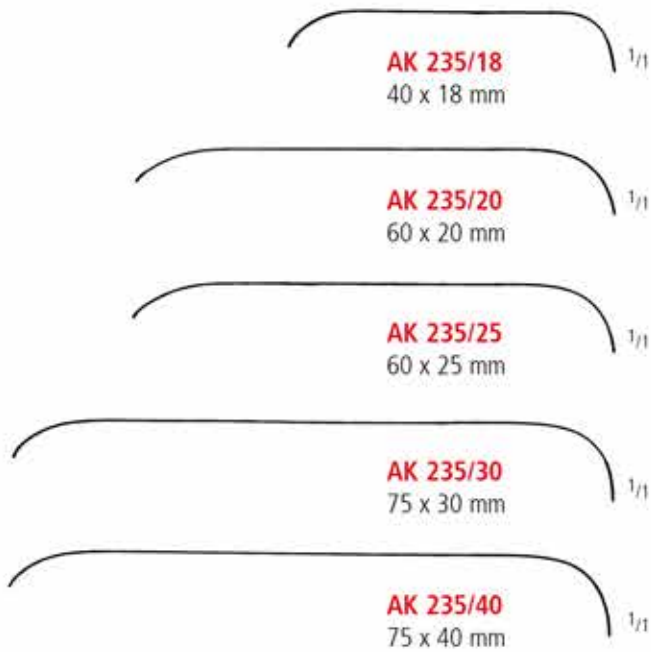

SAUERBRUCH
22,5 cm/8³/₄"



AK 237/01
50 x 55 mm

MORRIS
26,0 cm/10¹/₂"



AK 237/02
70 x 40 mm

AK 237/03
70 x 50 mm

AK 237/04
70 x 65 mm

MORRIS
25 cm/10"



60 x 50 mm

60 x 45 mm

MORRIS
AK 238/24
25,0 cm/10"

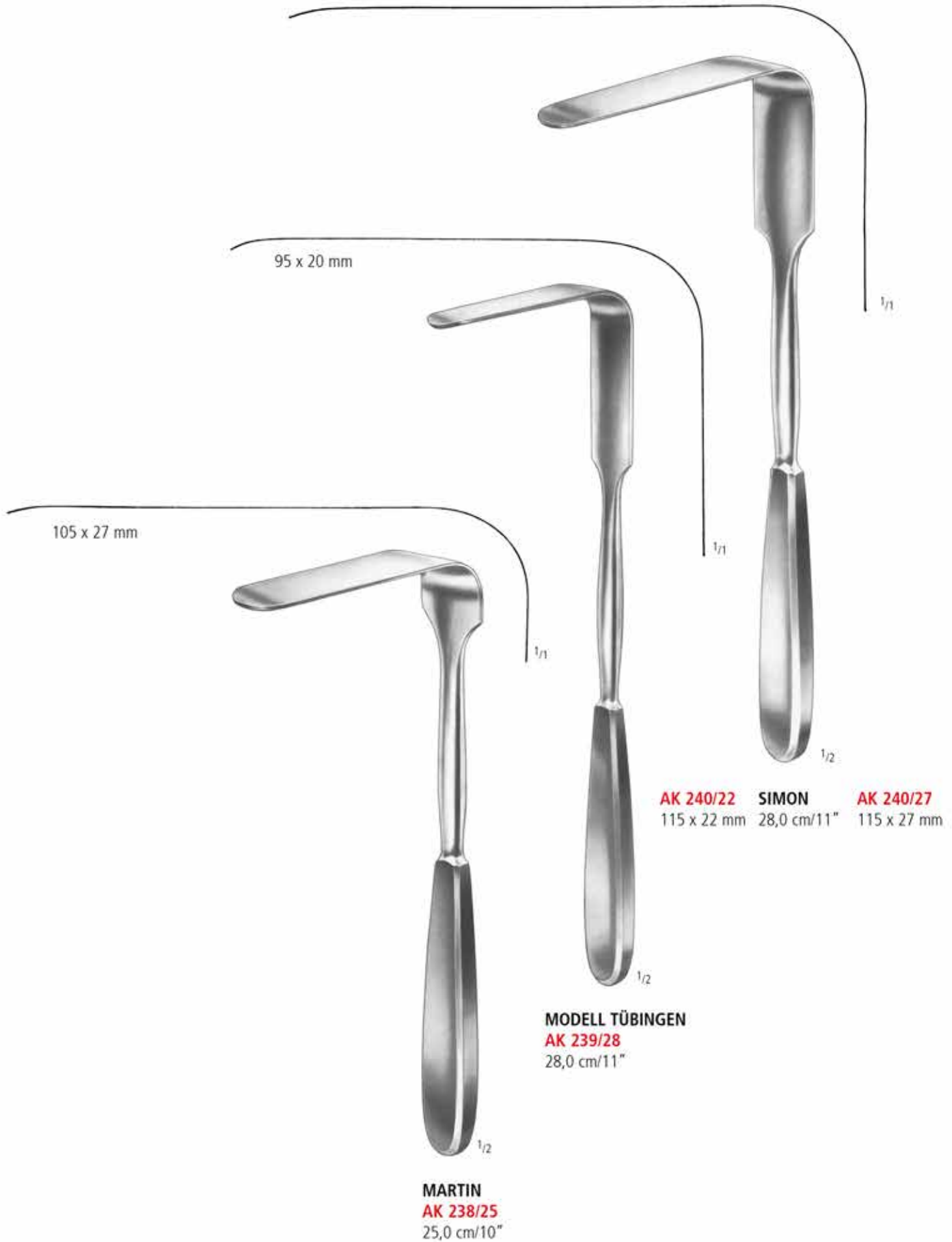

AA
AB
AC
AD
AE
AF
AK
AL
AM
AO
AP
AR
KA
KD
KU
KY

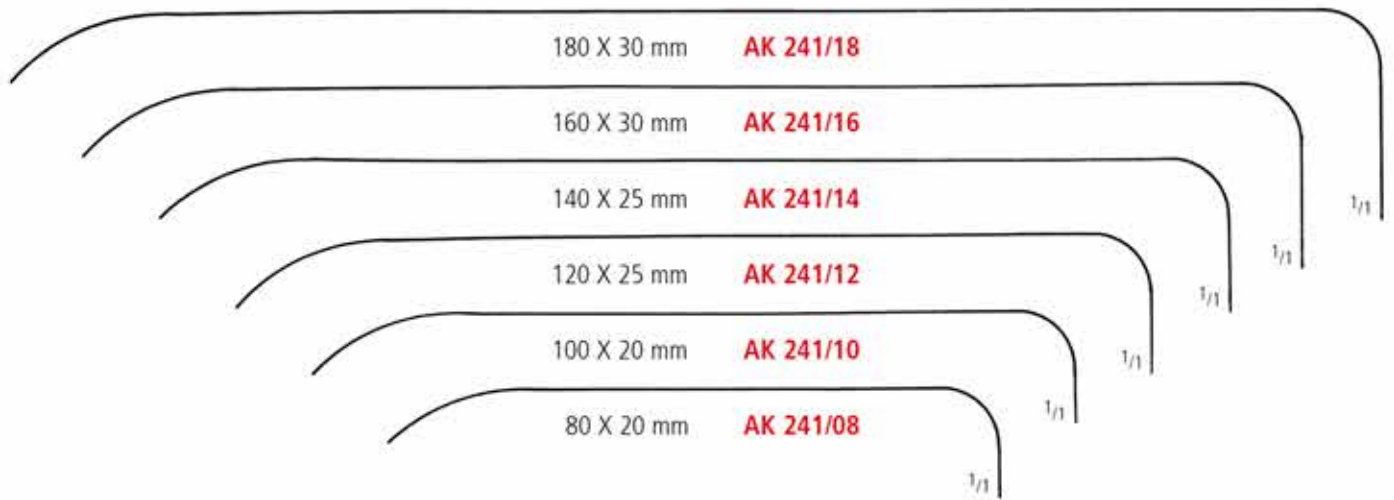

BRUNNER
AK 241/08-18
25,0 cm/10"



LAHEY
AK 242/19
19,0 cm/7 1/2"



LITTLE
AK 243/20
20,0 cm/8"

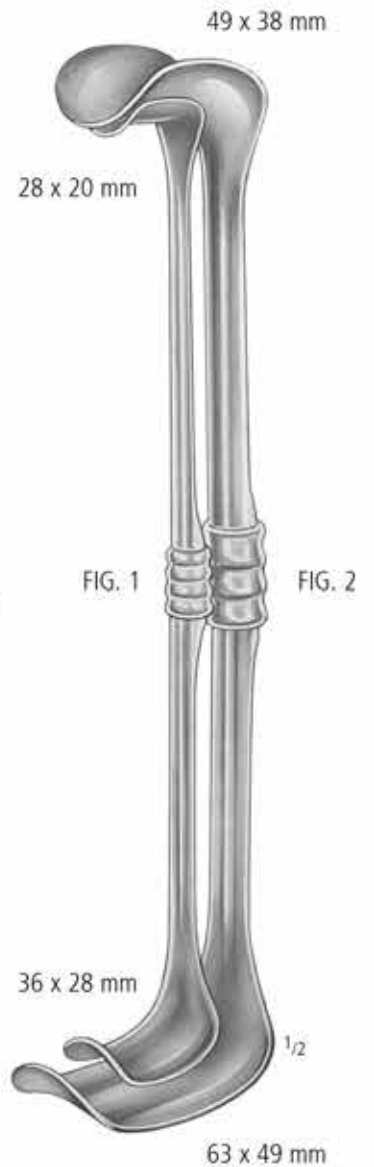
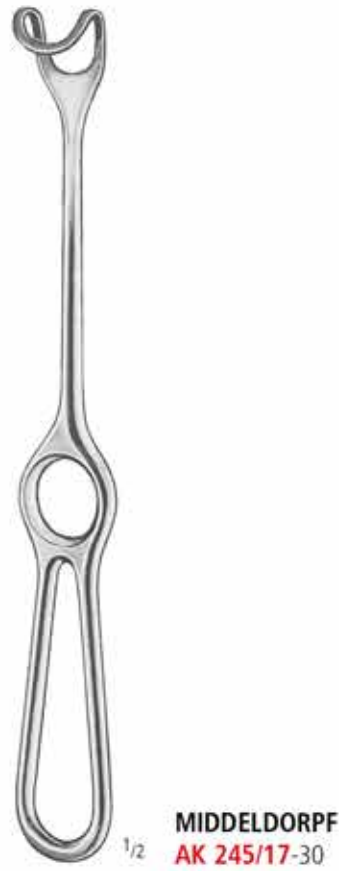

RICHARDSON-EASTMAN
FIG. 1+2 **AK 248/00**
FIG. 1 26,0 cm/10¹/₂" **AK 248/01**
FIG. 2 28,0 cm/11" **AK 248/02**

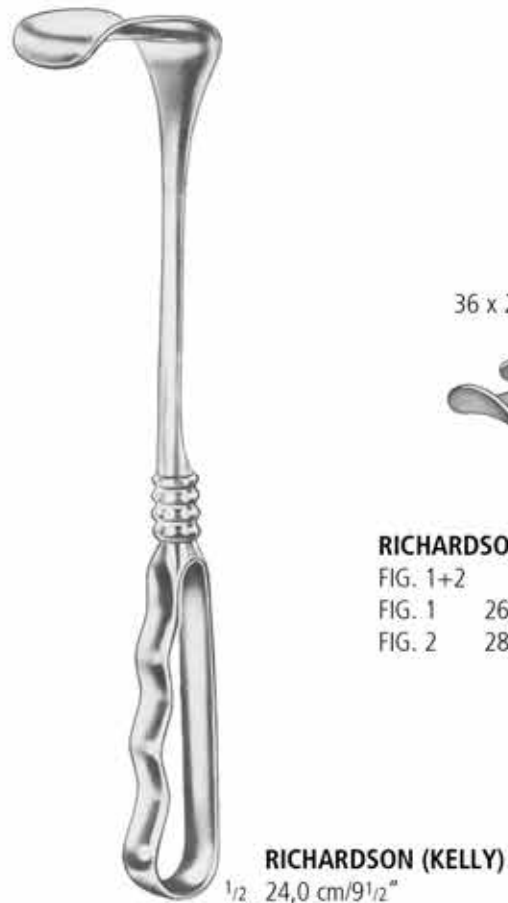



HOESEL
25,0 cm/10"



AK 250/01
60 x 20 mm



AK 250/02
80 x 30 mm



AK 250/03
100 x 30 mm



AK 250/04
120 x 30 mm



AK 250/05
140 x 30 mm



AK 250/06
140 x 40 mm

AA
AB
AC
AD
AE
AF
AK
AL
AM
AO
AP
AR
KA
KD
KU
KY

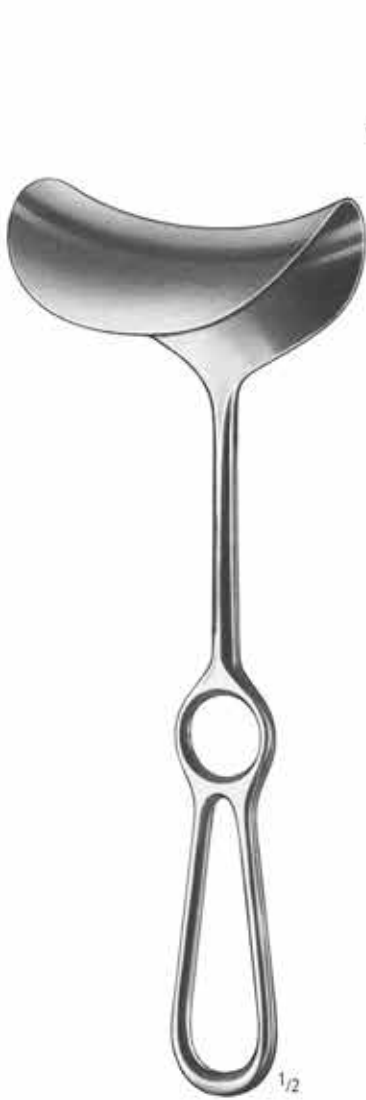

FRITSCH
24,0 cm / 9½"

- 45 x 40 mm **AK 254/40**
- 45 x 50 mm **AK 254/50**
- 45 x 60 mm **AK 254/60**
- 45 x 75 mm **AK 254/75**
- 65 x 85 mm **AK 254/85**

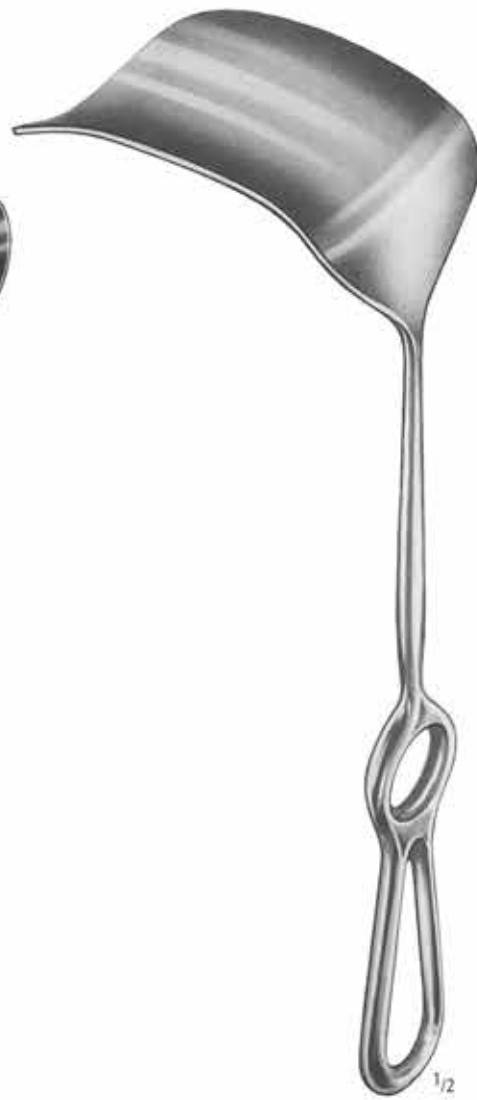

KOCHER

- 70 x 25 mm 22,0 cm / 8¾" **AK 256/25**
- 80 x 42 mm 25,0 cm / 10" **AK 256/42**
- 80 x 50 mm 25,0 cm / 10" **AK 256/50**
- 80 x 60 mm 25,0 cm / 10" **AK 256/60**



DOYEN-STILLE
24,0 cm / 9½"

- 90 x 15 mm **AK 258/15**
- 90 x 20 mm **AK 258/20**
- 90 x 30 mm **AK 258/30**
- 110 x 35 mm **AK 258/35**
- 110 x 40 mm **AK 258/40**
- 120 x 55 mm **AK 258/55**

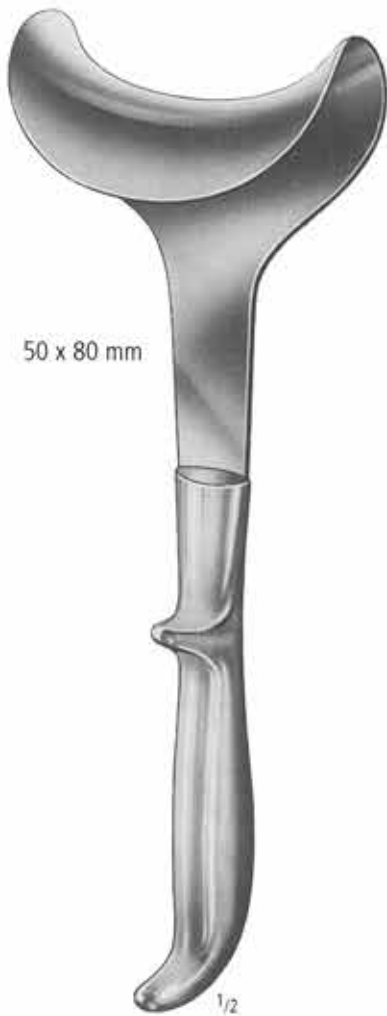
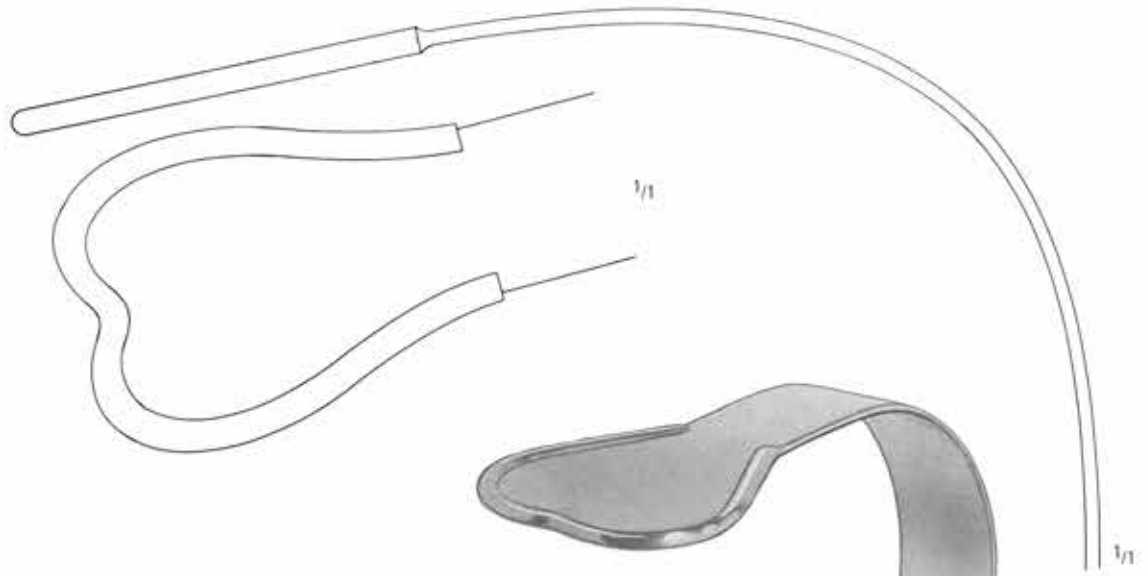

50 x 80 mm

1/2

DOYEN
AK 280/25
25,0 cm/10"



64 x 60 mm

1/2

TUFFIER
AK 282/23
23,0 cm/9"



1/2

HARRINGTON
32,0 cm/12³/₄"
127 x 40 mm **AK 284/40**
127 x 62 mm **AK 284/62**
175 x 64 mm **AK 284/64**

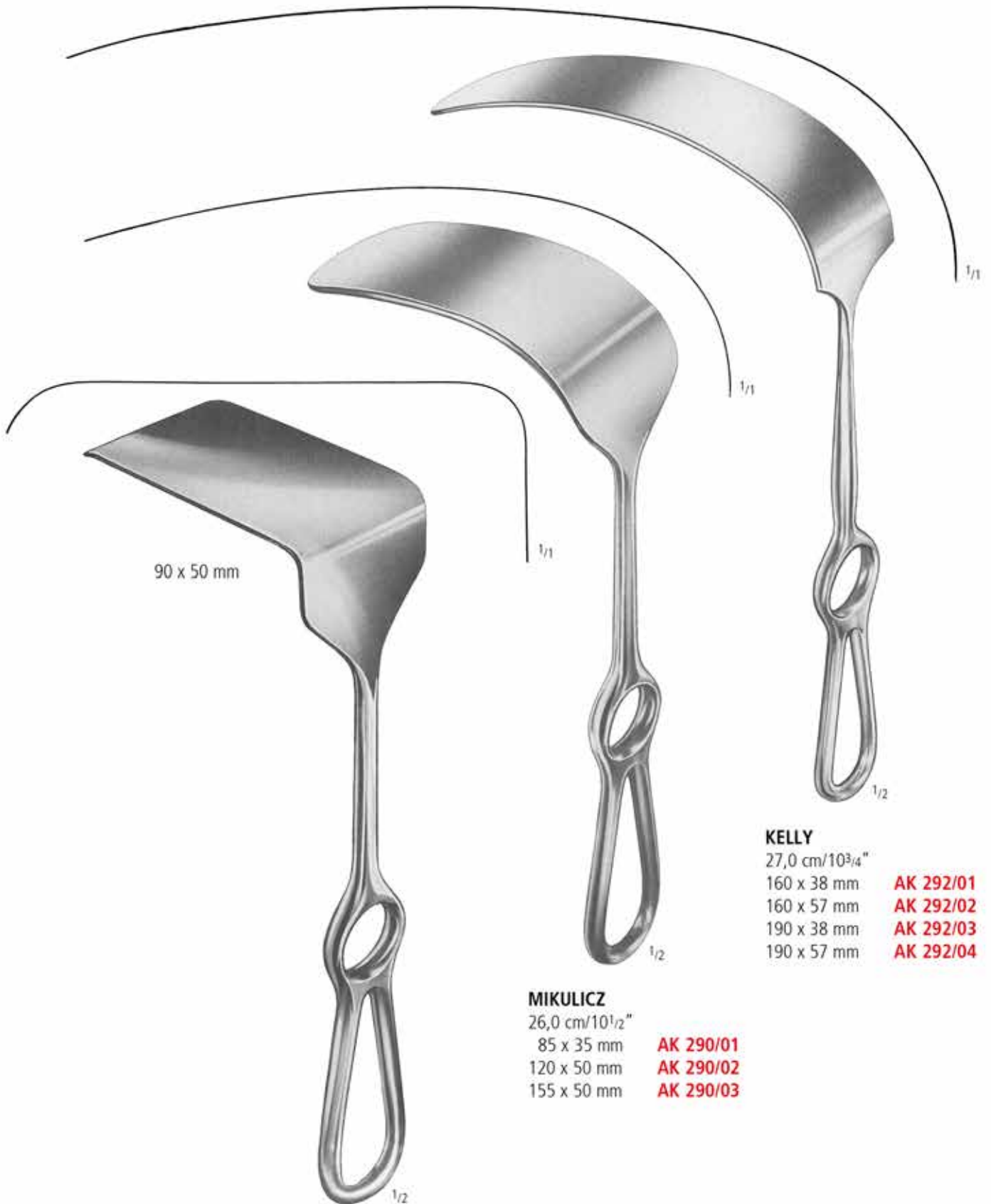

90 x 50 mm

MIKULICZ
AK 286/26
 26,0 cm/10¹/₂"

MIKULICZ
 26,0 cm/10¹/₂"
 85 x 35 mm **AK 290/01**
 120 x 50 mm **AK 290/02**
 155 x 50 mm **AK 290/03**

KELLY
 27,0 cm/10³/₄"
 160 x 38 mm **AK 292/01**
 160 x 57 mm **AK 292/02**
 190 x 38 mm **AK 292/03**
 190 x 57 mm **AK 292/04**



DEAVER
AK 300/01
18,0 cm/7"

DEAVER
AK 300/02
21,5 cm/8 1/2"

DEAVER
AK 300/03
23,0 cm/9"

DEAVER
AK 300/04
30,0 cm/12"

DEAVER
AK 300/05
33,0 cm/13"

DEAVER
AK 300/06
36,0 cm/14"



38 mm

DEAVER
AK 300/07
30,0 cm/12"



50 mm

DEAVER
AK 300/08
30,0 cm/12"



75 mm

DEAVER
AK 300/09
30,0 cm/12"

AA

AB

AC

AD

AE

AF

AK

AL

AM

AO

AP

AR

KA

KD

KU

KV

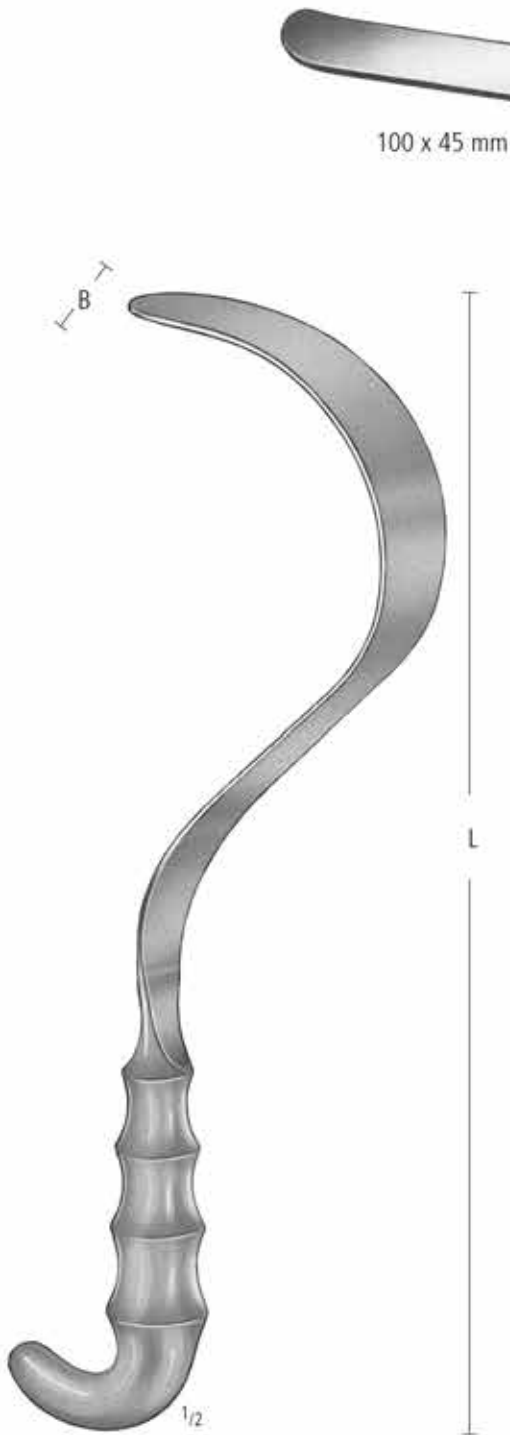

DEAVER
AK 310/01-05

	B	L	
Fig. 1	25 mm	30,5 cm/12"	AK 310/01
Fig. 2	25 mm	33,0 cm/13"	AK 310/02
Fig. 3	38 mm	30,5 cm/12"	AK 310/03
Fig. 4	50 mm	30,5 cm/12"	AK 310/04
Fig. 5	75 mm	30,5 cm/12"	AK 310/05

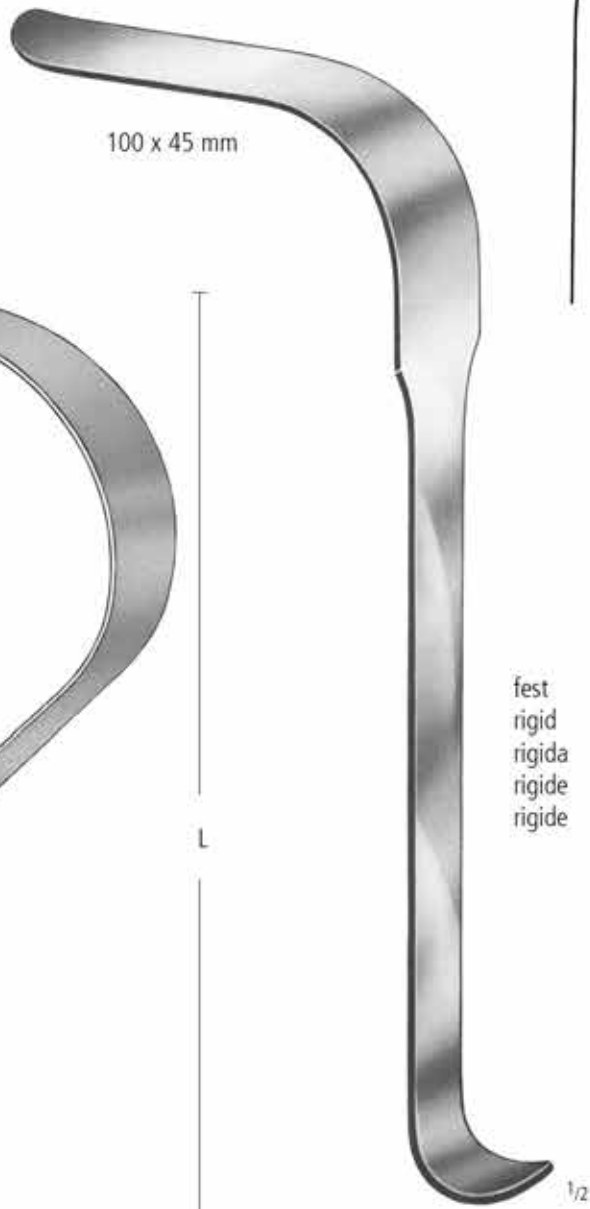

KOERTE
AK 312/28
28,0 cm / 11"

fest
rigid
rigida
rigide
rigide

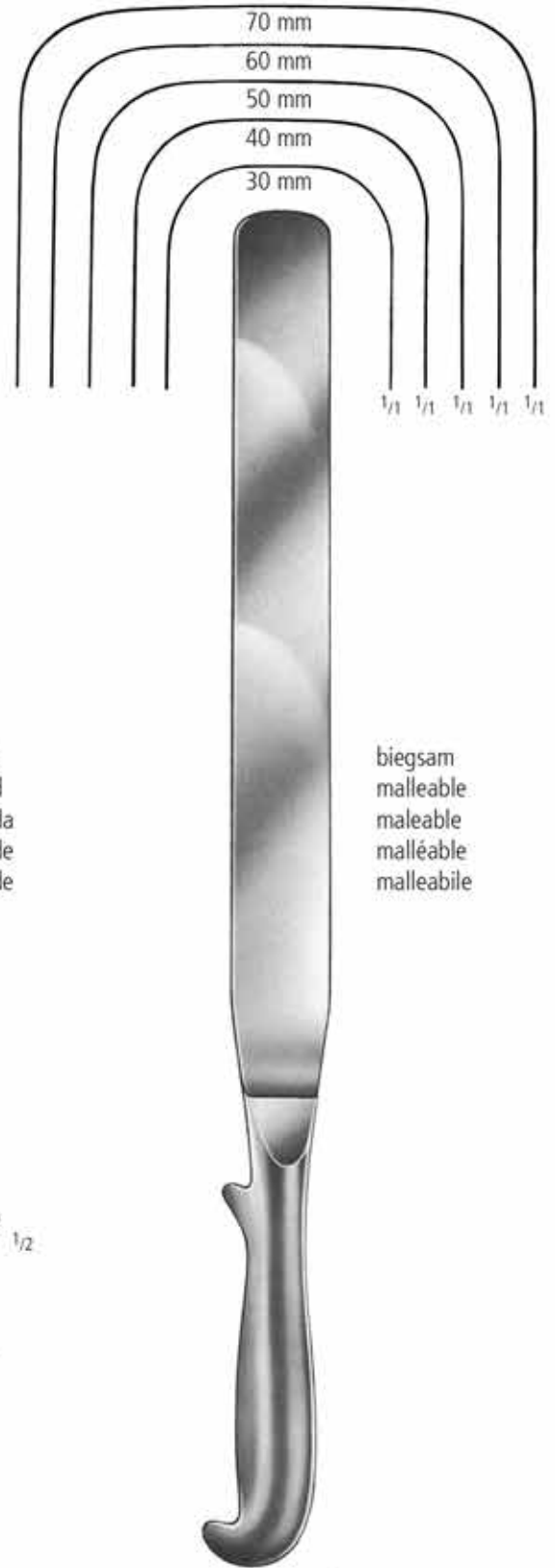

245 x 30 mm	AK 315/30	
245 x 40 mm	AK 315/40	
245 x 50 mm	AK 315/50	
245 x 60 mm	AK 315/60	
245 x 70 mm	AK 315/70	

biegsam
malleable
maleable
malléable
malleabile

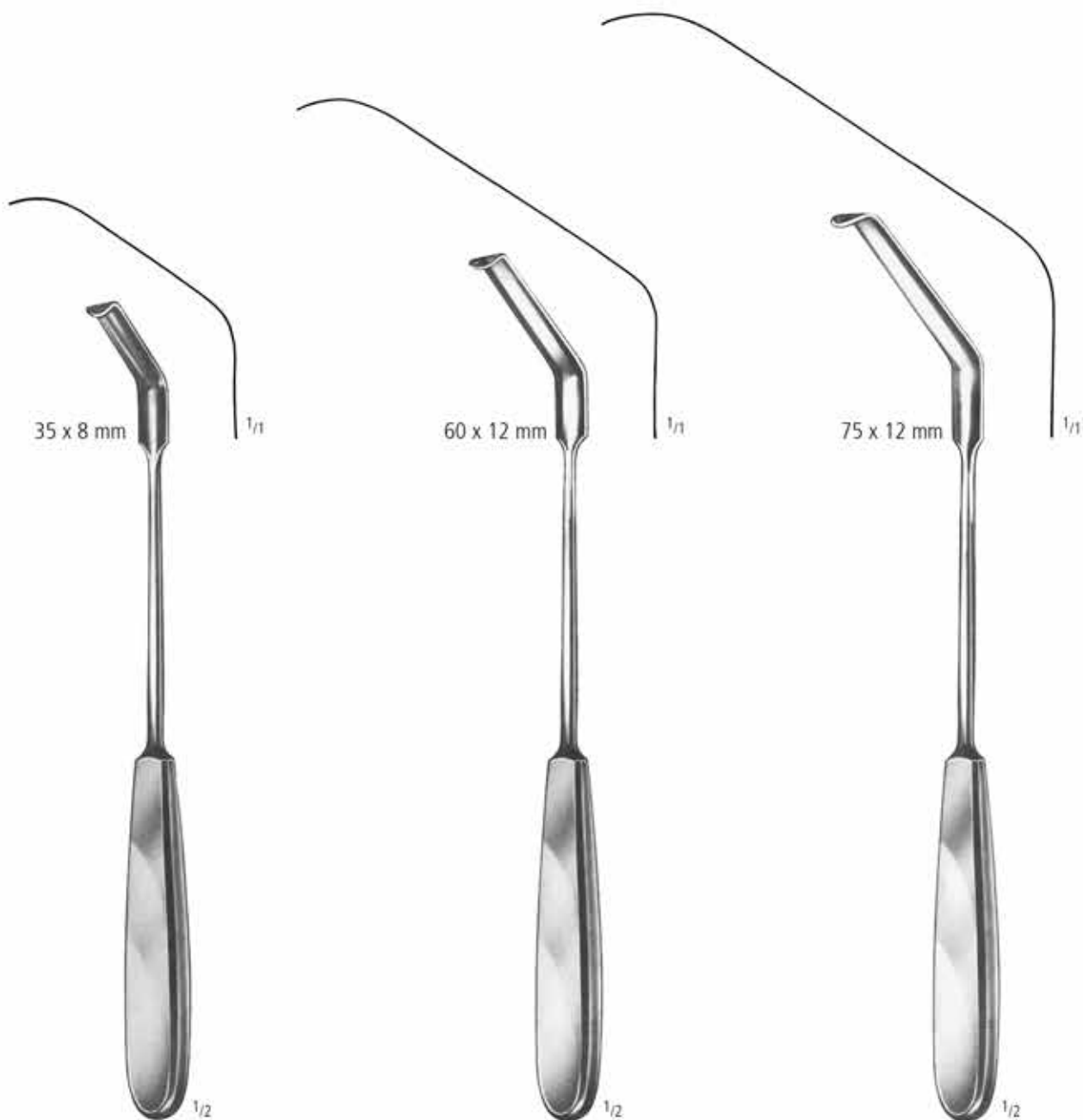

35 x 8 mm

$\frac{1}{11}$

$\frac{1}{2}$

ZENKER
AK 318/35
25,0 cm/10"

60 x 12 mm

$\frac{1}{11}$

$\frac{1}{2}$

ZENKER
AK 318/60
26,0 cm/10 $\frac{1}{2}$ "

75 x 12 mm

$\frac{1}{11}$

$\frac{1}{2}$

ZENKER
AK 318/75
27,5 cm/10 $\frac{3}{4}$ "

AK 320/16
50 x 16 mm



AK 320/25
75 x 25 mm



AK 320/50
90 x 50 mm



MEYERDING
22,5 cm/9"

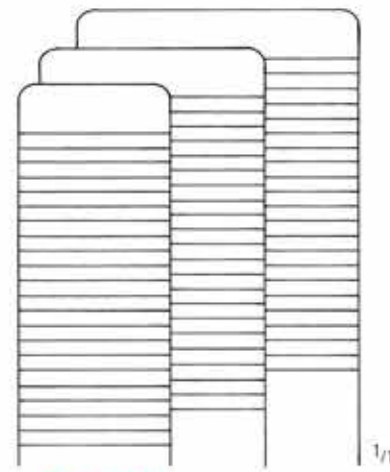

AK 325/20
— 20 mm —

AK 325/30
— 30 mm —

AK 325/40
— 40 mm —

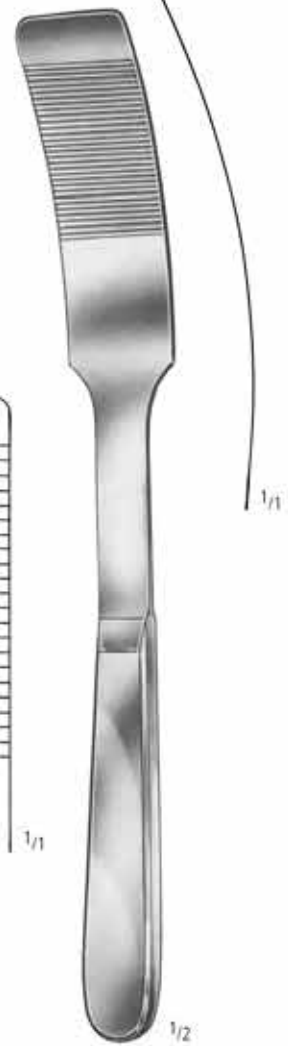

KADER
27,0 cm/10³/₄"

AA
AB
AC
AD
AE
AF
AK
AL
AM
AO
AP
AR
KA
KD
KU
KY



AK 328/22
82 x 22 mm



AK 328/38
115 x 38 mm



AK 328/65
115 x 65 mm



130 x 38 mm

CORYLLOS
24,0 cm/9 1/2"

SAUERBRUCH
AK 330/25
25,0 cm/10"

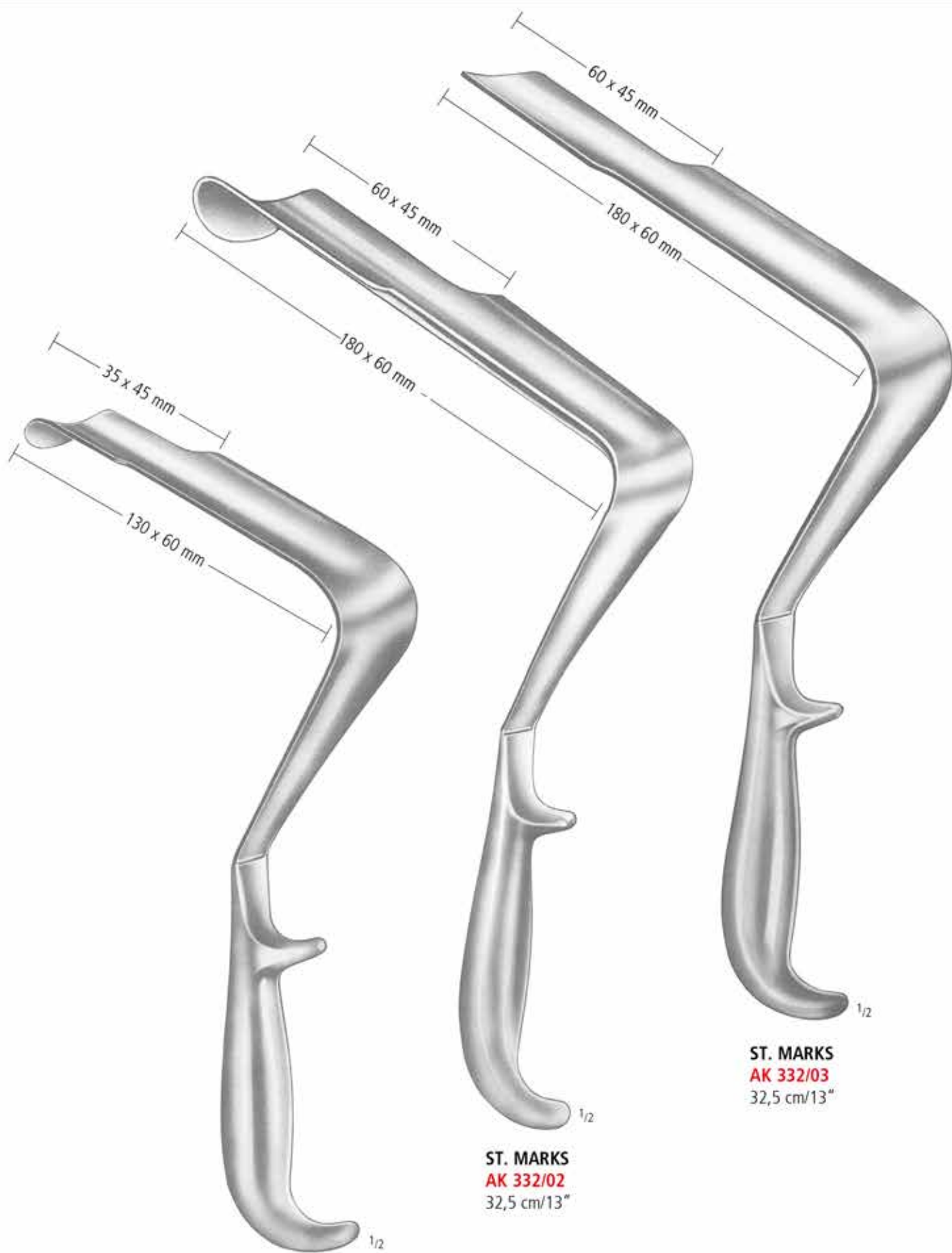

ST. MARKS
AK 332/01
29,0 cm/11 1/2"

ST. MARKS
AK 332/02
32,5 cm/13"

ST. MARKS
AK 332/03
32,5 cm/13"

- AA
- AB
- AC
- AD
- AE
- AF
- AK**
- AL
- AM
- AO
- AP
- AR
- KA
- KD
- KU
- KY



75 x 50 mm

DAVIDSON
AK 337/50
16,0 cm/6¹/₄"



75 x 90 mm

DAVIDSON
AK 337/90
16,0 cm/6¹/₄"



HEANEY
27,0 cm/10³/₄"
45 x 25 mm **AK 340/01**
73 x 28 mm **AK 340/02**
82 x 28 mm **AK 340/03**

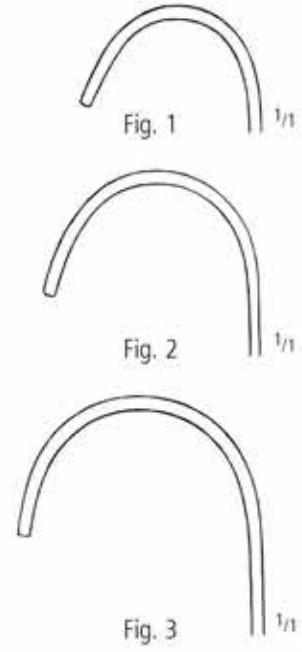

ROUX
16,5 cm/6¹/₂"
Fig. 1+2+3 **AK 350/00**
Fig. 1 **AK 350/01**
Fig. 2 **AK 350/02**
Fig. 3 **AK 350/03**

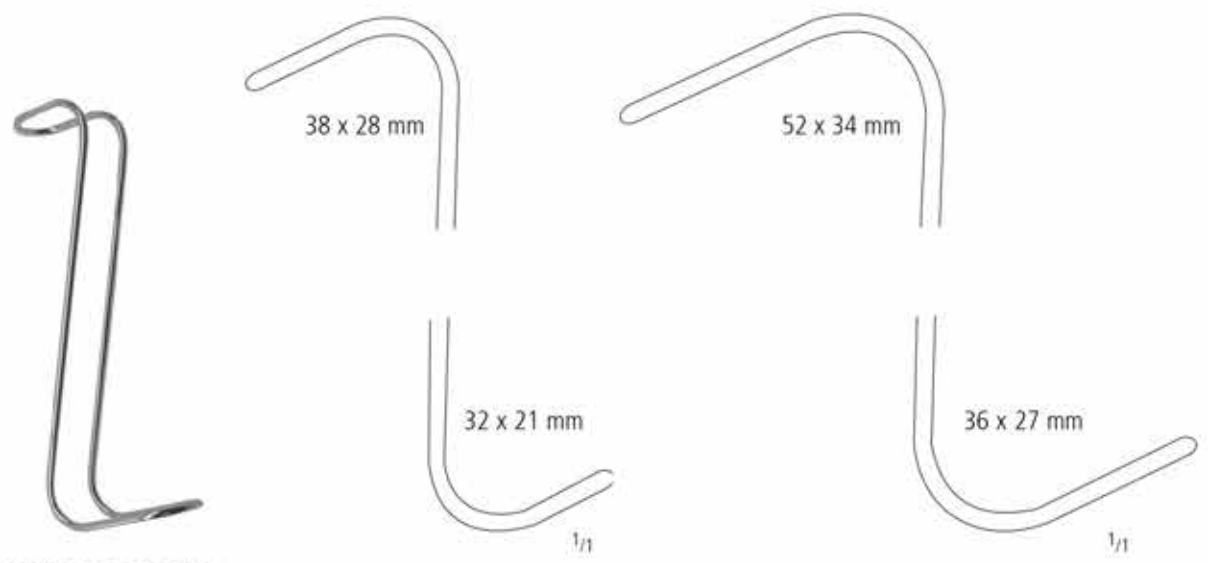

COLLIN-HARTMANN
14,0 cm/5¹/₂" **AK 351/14**
16,0 cm/6¹/₄" **AK 351/16**



FARABEUF
AK 352/00 Fig. 1+2
12,0 cm/4³/₄"



FARABEUF
AK 354/00 Fig. 1+2
15,0 cm/6"



PARKER
AK 373/00 Fig. 1+2
13,5 cm/5¹/₄"



PARKER
AK 374/00 Fig. 1+2
18,0 cm/7"



MATHIEU
AK 380/00 Fig. 1+2
20,0 cm/8"

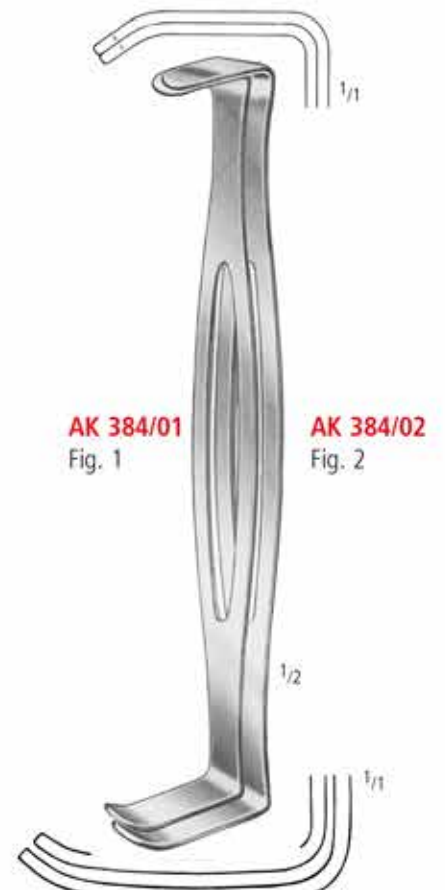

PARKER-LANGENBECK (U.S. Army)
AK 384/00 Fig. 1+2
21,0 cm/8¹/₄"



CZERNY
AK 386/17
17,5 cm/7"



GOELET
AK 390/19
19,0 cm/7 1/2"

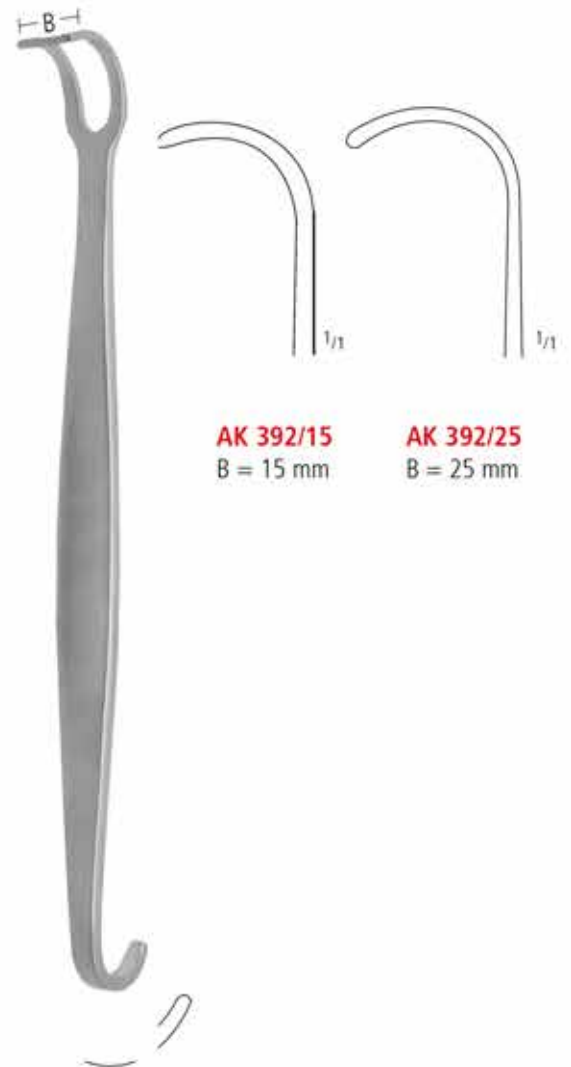

AK 392/15
B = 15 mm

AK 392/25
B = 25 mm

CANNY RYALL
21,5 cm/8 1/2"

AA
AB
AC
AD
AE
AF
AK
AL
AM
AO
AP
AR
KA
KD
KU
KY

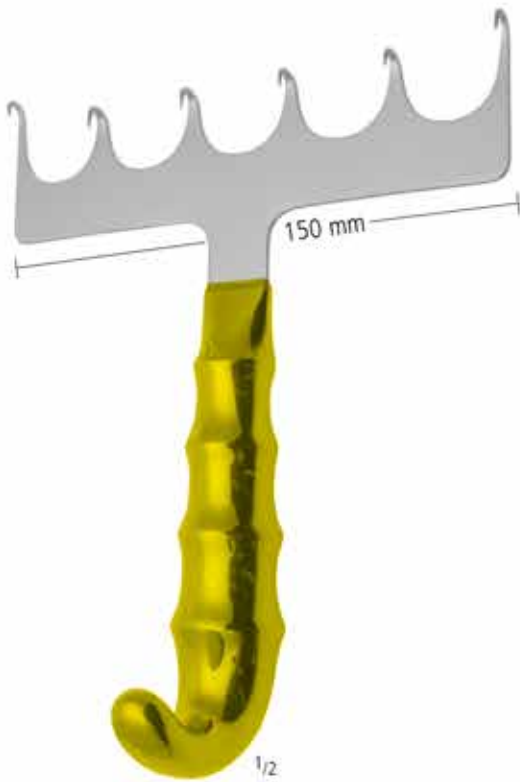

YANCOSKIE
AK 440/15
18,0 cm/7"



FERREIRA
AK 451/10
10 cm/4"

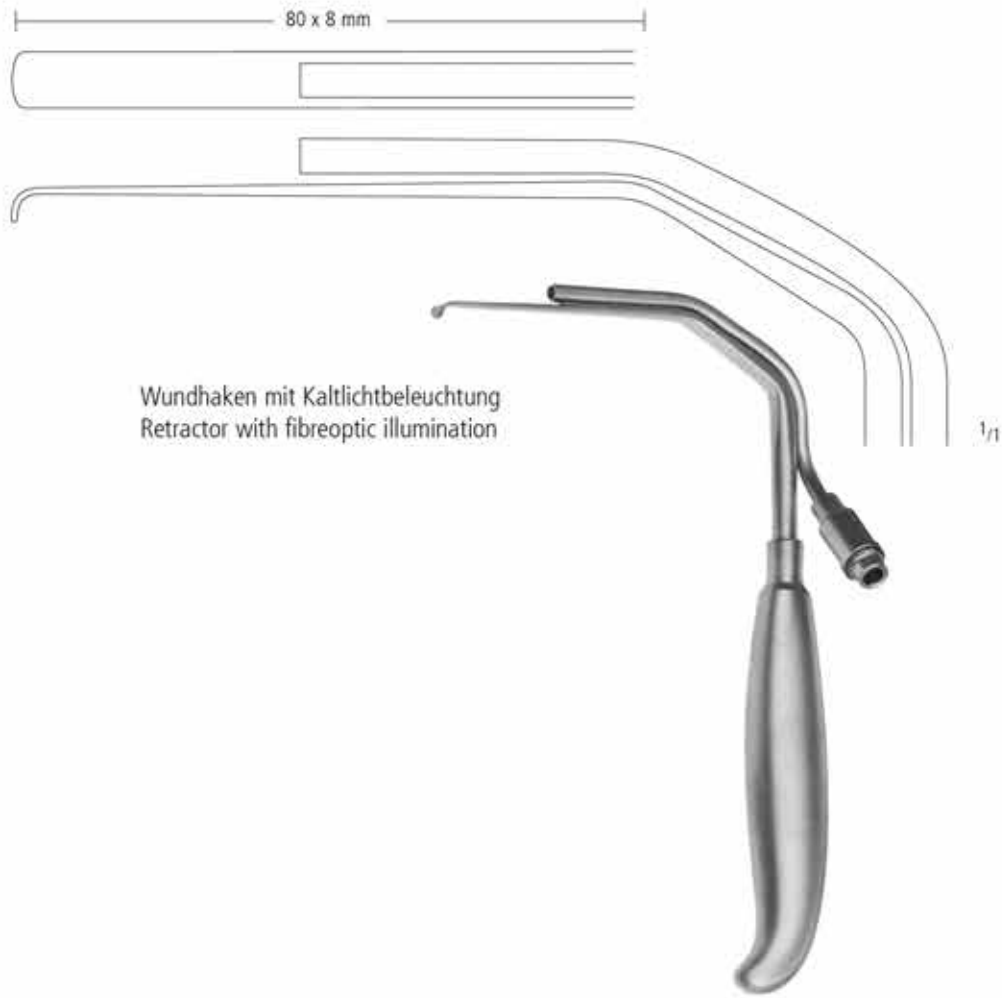

AK 452/15

AA
AB
AC
AD
AE
AF
AK
AL
AM
AO
AP
AR
KA
KD
KU
KY

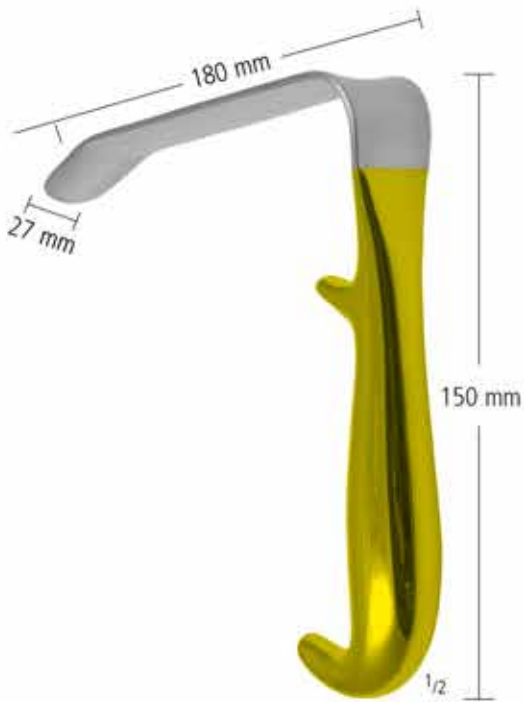

AK 455/01
18,0 cm/7"



AK 455/16
16,0 cm/6 1/4"
für Optik XP 709/30
for telescope XP 709/30



20,0 cm/8"
AK 456/18
AK 456/20
AK 456/23
18x200mm
20x200mm
23x200mm

WUNDHAKEN RETRACTORS SEPARADORES ECARTEURS DIVARICATORI

Selbthaltende Wundsperrer
Selfretaining Retractors
Separadores autoestaticos
Ecarteurs autostatiques
Divaricatori autostatici



FINSEN

5,0 cm/2"
7,0 cm/2³/₄"

AK 500/05

AK 500/07

AK 501/05

AK 501/07



AK 502/10

10,0 cm/4"

AK 503/10

Fingerwundspreizer
Finger retractor
Separador para dedos
Ecarteur
Divaricatori



AUSTRALIA

AK 505/01

5,0 cm/2"



ALM

7,0 cm/2³/₄"
10,0 cm/4"

AK 506/07

AK 506/10

AK 507/07

AK 507/10

AA
AB
AC
AD
AE
AF
AK
AL
AM
AO
AP
AR
KA
KD
KU
KY

Selbsthaltende Wundsperrer
 Selfretaining Retractors
 Separadores autoestaticos
 Ecarteurs autostatiques
 Divaricatori autostatici



JANSEN

 **AK 510/10**  **AK 511/10**
 10,0 cm/4"



SNITMAN

 **AK 514/10**  **AK 515/10**
 10,5 cm/4 1/4"

WUNDHAKEN RETRACTORS SEPARADORES ECARTEURS DIVARICATORI

Wundspreizer für die Handchirurgie
 Hand surgery retractors
 Separadores para la cirugía de la mano
 Ecarteurs de la chirurgie de la main
 Divaricatori per la chirurgia della mano



AUSTRALIA Low profile
AK 516/00
 9,0 cm/3 1/2\"/>



AUSTRALIA Low profile
AK 517/00
 9,0 cm/3 1/2\"/>



AUSTRALIA Low profile
AK 518/00
 9,0 cm/3 1/2\"/>



6,5 cm/2 1/2\"/>



Fig. 1
AK 518/12
 10 x 12 mm



Fig. 2
AK 518/18
 10 x 18 mm

AA
 AB
 AC
 AD
 AE
 AF
AK
 AL
 AM
 AO
 AP
 AR
 KA
 KD
 KU
 KY



Selbsthaltende Wundsperrer
Selfretaining Retractors
Separadores autoestaticos
Ecarteurs autostatiques
Divaricatori autostatici

WEITLANER



WEITLANER-BABY
AK 519/14
14,0 cm/5 1/2"



WEITLANER
AK 520/13 AK 521/13
13,0 cm/5"



WEITLANER

10,5 cm/4 1/4"	2 x 3
13,0 cm/5"	3 x 4
16,5 cm/6 1/2"	3 x 4
20,0 cm/8"	3 x 4
25,0 cm/10"	3 x 4
26,0 cm/10 1/2"	5 x 6

△	△
AK 522/10	AK 523/10
AK 524/13	AK 525/13
AK 526/16	AK 527/16
AK 528/20	AK 529/20
AK 530/25	AK 531/25
AK 532/26	AK 533/26

AA
AB
AC
AD
AE
AF
AK
AL
AM
AO
AP
AR
KA
KD
KU
KY

AK WUNDHAKEN RETRACTORS SEPARADORES ECARTEURS DIVARICATORI

Selbsthaltende Wundsperrer
Selfretaining Retractors
Separadores autoestaticos
Ecarteurs autostatiques
Divaricatori autostatici

komplett
complete
completo
complet
completo

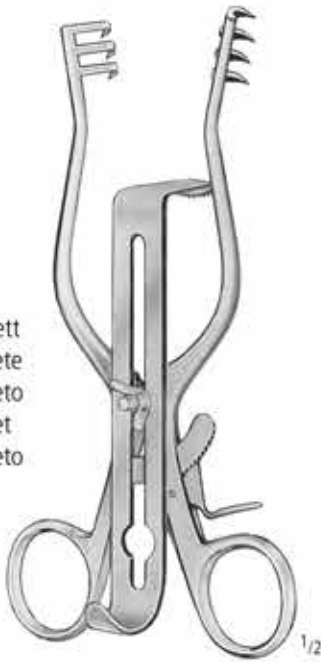

HENLEY

AK 536/00 AK 537/00
16,5 cm/6 1/2"



19 mm x 16 mm
AK 536/19



25 mm x 16 mm
AK 536/25



32 mm x 16 mm
AK 536/32



MILLIGAN

AK 538/13 AK 539/13
13,0 cm/5"



TRAVERS

AK 540/21
21,0 cm/8 1/4"

WUNDHAKEN RETRACTORS SEPARADORES ECARTEURS DIVARICATORI

Selbsthaltende Wundsperrer
Selfretaining Retractors
Separadores autoestaticos
Ecarteurs autostatiques
Divaricatori autostatici



SCHUHKNECHT
 ^ ^
AK 542/14 **AK 543/14**
 14,0 cm/5¹/₂"



WULLSTEIN
 ^ ^
 10,5 cm/4¹/₄" **AK 544/10** **AK 545/10**
 13,0 cm/5" **AK 544/13** **AK 545/13**
 16,0 cm/6¹/₄" **AK 544/16** **AK 545/16**



MOLLISON
 ^ ^
AK 550/15 **AK 551/15**
 15,0 cm/6"



MISKIMON
 ^ ^
AK 552/22 **AK 553/22**
 22,0 cm/8³/₄"

AA
AB
AC
AD
AE
AF
AK
AL
AM
AO
AP
AR
KA
KD
KU
KY

AK WUNDHAKEN RETRACTORS SEPARADORES ECARTEURS DIVARICATORI

Selbthaltende Wundsperr
 Selfretaining Retractors
 Separadores autoestaticos
 Ecarteurs autostatiques
 Divaricatori autostatici



ADSON
 AK 554/20 AK 555/20
 20,0 cm/8"



ANDERSON-ADSON
 AK 556/20 AK 557/20
 20,0 cm/8"

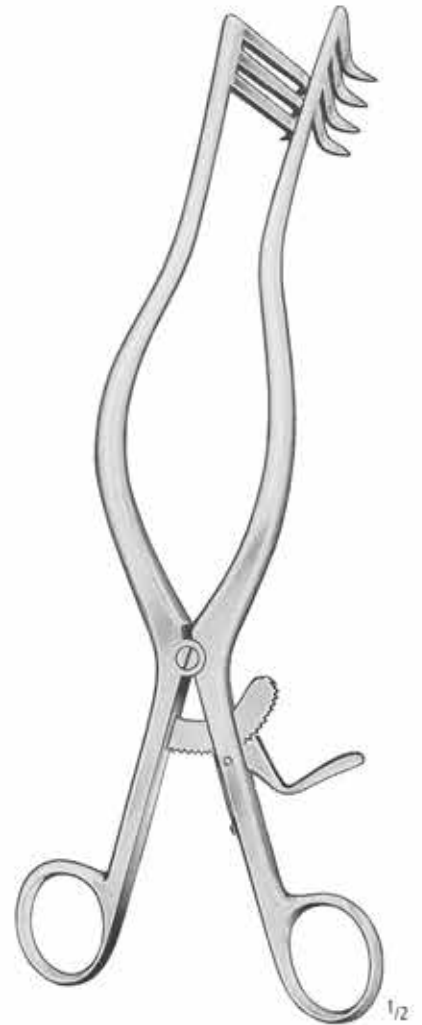

ADSON
 AK 558/27 AK 559/27
 27,0 cm/10³/₄"

WUNDHAKEN RETRACTORS SEPARADORES ECARTEURS DIVARICATORI

Selbsthaltende Wundsperrer
Selfretaining Retractors
Separadores autoestaticos
Ecarteurs autostatiques
Divaricatori autostatici



ADSON
AK 560/27
27,0 cm/10³/₄"



ADSON-R
AK 561/01
27,0 cm/10³/₄"



ADSON-L
AK 561/02
27,0 cm/10³/₄"

AA
AB
AC
AD
AE
AF
AK
AL
AM
AO
AP
AR
KA
KD
KU
KY

AK WUNDHAKEN RETRACTORS SEPARADORES ECARTEURS DIVARICATORI

Selbsthaltende Wundsperrer
Selfretaining Retractors
Separadores autoestaticos
Ecarteurs autostatiques
Divaricatori autostatici



ADSON-BABY
AK 562/14
14,0 cm/5 1/2"



13,0 cm/5"
16,5 cm/6 1/2"
20,0 cm/8"
25,0 cm/10"

3 x 4
3 x 4
3 x 4
3 x 4

^
AK 564/13
AK 564/16
AK 564/20
AK 564/25

∩
AK 565/13
AK 565/16
AK 565/20
AK 565/25

31,0 cm/12 1/4"
33,0 cm/13"

4 x 4
4 x 5

^
AK 566/31
AK 568/33

∩
AK 567/31
AK 569/33



BECKMANN

WUNDHAKEN RETRACTORS SEPARADORES ECARTEURS DIVARICATORI

Selbsthaltende Wundsperrer
Selfretaining Retractors
Separadores autoestaticos
Ecarteurs autostatiques
Divaricatori autostatici



25 x 25 mm
25 x 31 mm
25 x 40 mm
25 x 45 mm

^
AK 570/01
AK 570/02
AK 570/03
AK 570/04

∩
AK 571/01
AK 571/02
AK 571/03
AK 571/04

BECKMANN-ADSON
31,0 cm/12¹/₄"



BECKMANN-EATON
^ ∩
AK 572/33 AK 573/33
33,0 cm/13"

AA
AB
AC
AD
AE
AF
AK
AL
AM
AO
AP
AR
KA
KD
KU
KY

Selbsthaltende Wundsperrer
Selfretaining Retractors
Separadores autoestaticos
Ecarteurs autostatiques
Divaricatori autostatici



SCALP-CONTOUR

 **AK 574/14**
 **AK 575/14**
 14,0 cm/5½"



GELPI

9,0 cm/3½" **AK 580/09**
 11,0 cm/4⅓" **AK 580/11**
 14,0 cm/5½" **AK 580/14**
 19,0 cm/7½" **AK 580/19**



GELPI

AK 581/19
 19,0 cm/7½"



MEYERDING

18,0 cm/7"
 32 x 25 mm **AK 582/01**
 54 x 25 mm **AK 582/02**
 60 x 19 mm **AK 582/03**
 60 x 25 mm **AK 582/04**

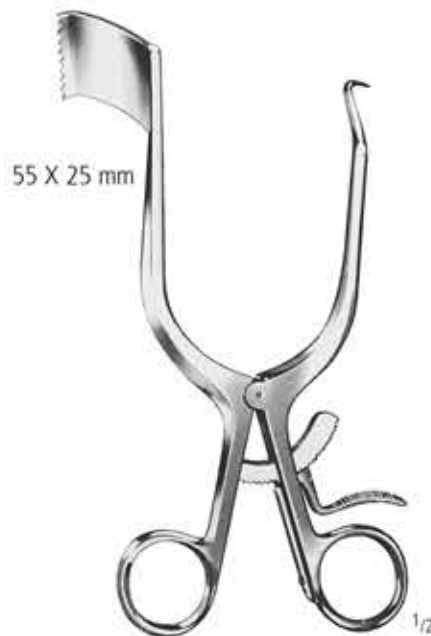

55 X 25 mm

MARKHAM-MEYERDING

AK 583/01
 18,0 cm/7"



55 X 25 mm

MARKHAM-MEYERDING

AK 583/02
 18,0 cm/7"

WUNDHAKEN RETRACTORS SEPARADORES ECARTEURS DIVARICATORI

Selbsthaltende Wundsperrer
Selfretaining Retractors
Separadores autoestaticos
Ecarteurs autostatiques
Divaricatori autostatici

AA
AB
AC
AD
AE
AF
AK
AL
AM
AO
AP
AR
KA
KD
KU
KY



RIGBY
18,0 cm/7"

- 35 x 20 mm **AK 586/01**
- 60 x 20 mm **AK 586/02**
- 65 x 15 mm **AK 586/03**



DARLING
AK 587/01
18,0 cm/7"



DARLING
AK 587/02
18,0 cm/7"



PLESTER
AK 590/10 10,0 cm/4"
AK 590/13 13,0 cm/5"



PLESTER-R
AK 591/10 10,0 cm/4"
AK 591/13 13,0 cm/5"



PLESTER-L
AK 592/10 10,0 cm/4"
AK 592/13 13,0 cm/5"

Selbsthaltende Wundsperrer
 Selfretaining Retractors
 Separadores autoestaticos
 Ecarteurs autostatiques
 Divaricatori autostatici



TÜBINGER MODELL

AK 594/16
 16,5 cm/6¹/₂"

AK 594/18
 18,0 cm/7"



MAYO-ADAMS
AK 596/17
 17,0 cm/6³/₄"

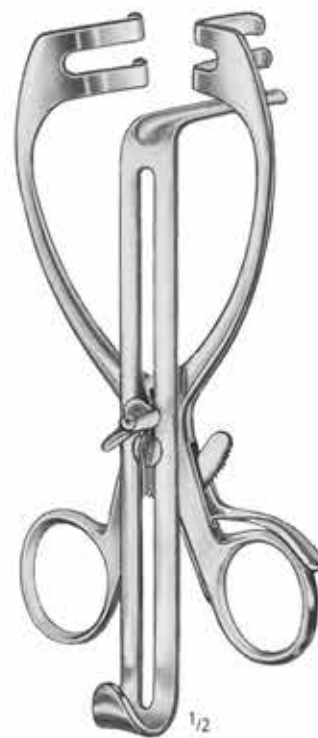

MAYO-ADAMS
AK 598/17
 17,0 cm/6³/₄"

WUNDHAKEN RETRACTORS SEPARADORES ECARTEURS DIVARICATORI

Selbsthaltende Wundsperrer
 Selfretaining Retractors
 Separadores autoestaticos
 Ecarteurs autostatiques
 Divaricatori autostatici



WALTON
AK 599/01
 18,0 cm/7"



WALTON
AK 599/02
 18,0 cm/7"



KNIGHTON
AK 600/01
 18,0 cm/7"



KNIGHTON
AK 600/02
 18,0 cm/7"

AA
 AB
 AC
 AD
 AE
 AF
AK
 AL
 AM
 AO
 AP
 AR
 KA
 KD
 KU
 KY

Bauchdeckenhalter
 Abdominal Retractors
 Separadores abdominales
 Ecarteurs abdominaux
 Divaricatori addominali

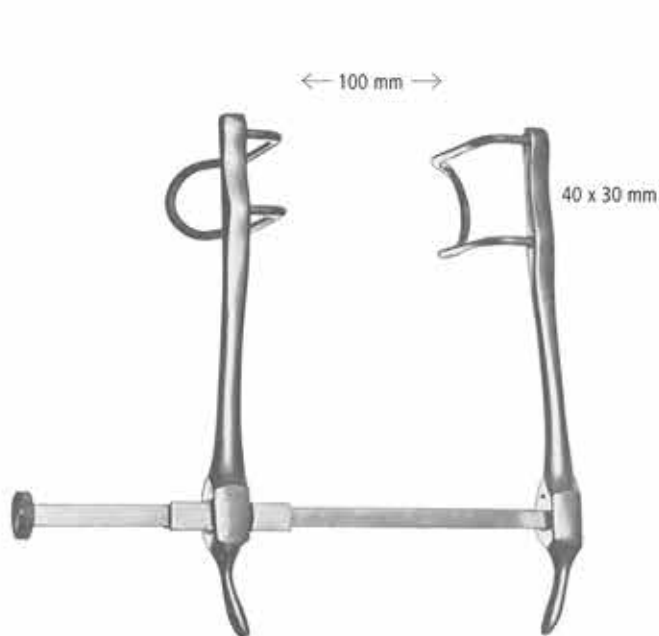

GOSSET
AK 610/10

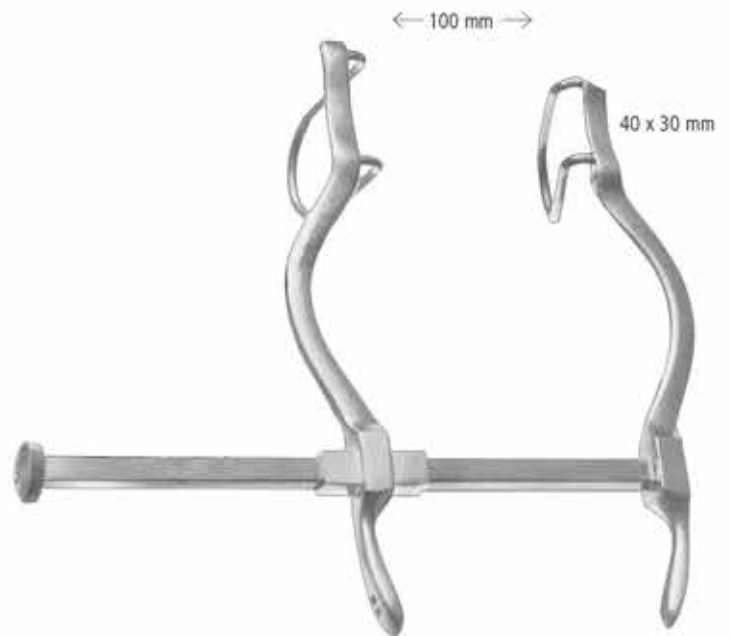

GOSSET
AK 611/10

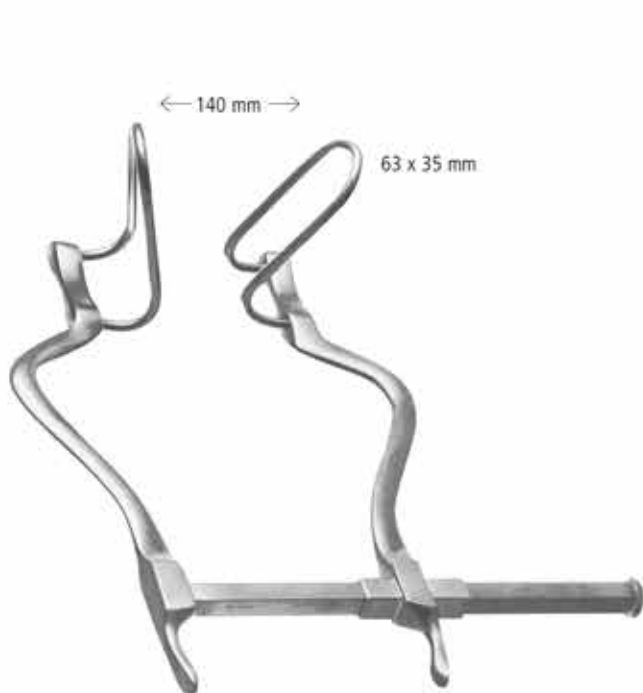

GOSSET
AK 612/14

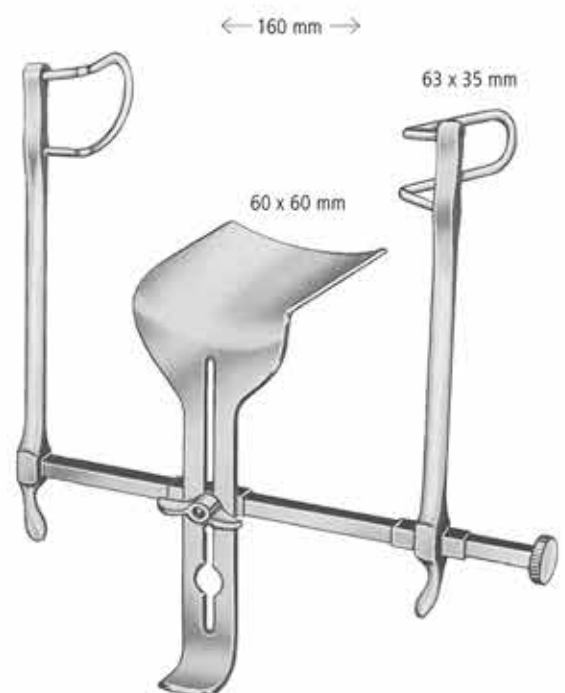

GOSSET
AK 613/16

WUNDHAKEN RETRACTORS SEPARADORES ECARTEURS DIVARICATORI

Bauchdeckenhalter
Abdominal Retractors
Separadores abdominales
Ecarteurs abdominaux
Divaricatori addominali

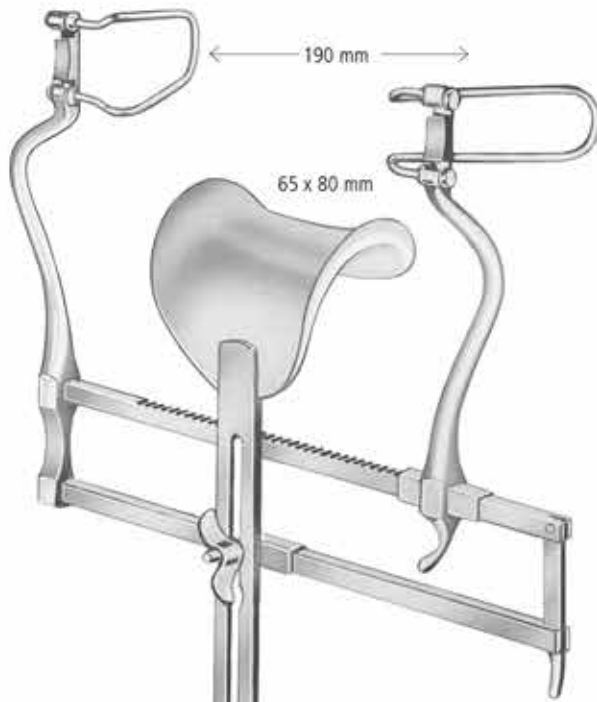

**BALFOUR
US-TYPE
AK 618/00**

komplett mit 2 Paar Valven
complete with 2 pairs of blades
completo con 2 pares de valvas
complet avec 2 paires de valves
completo con 2 paia di valve



**AK 618/01
70 x 35 mm**



**AK 618/02
100 x 35 mm**

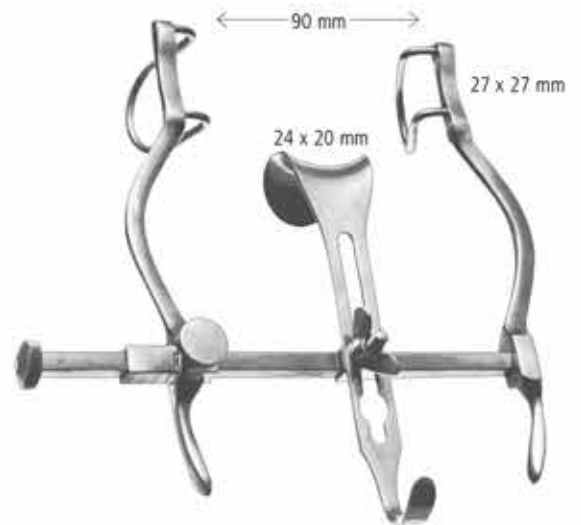

**BALFOUR BABY
AK 620/09**

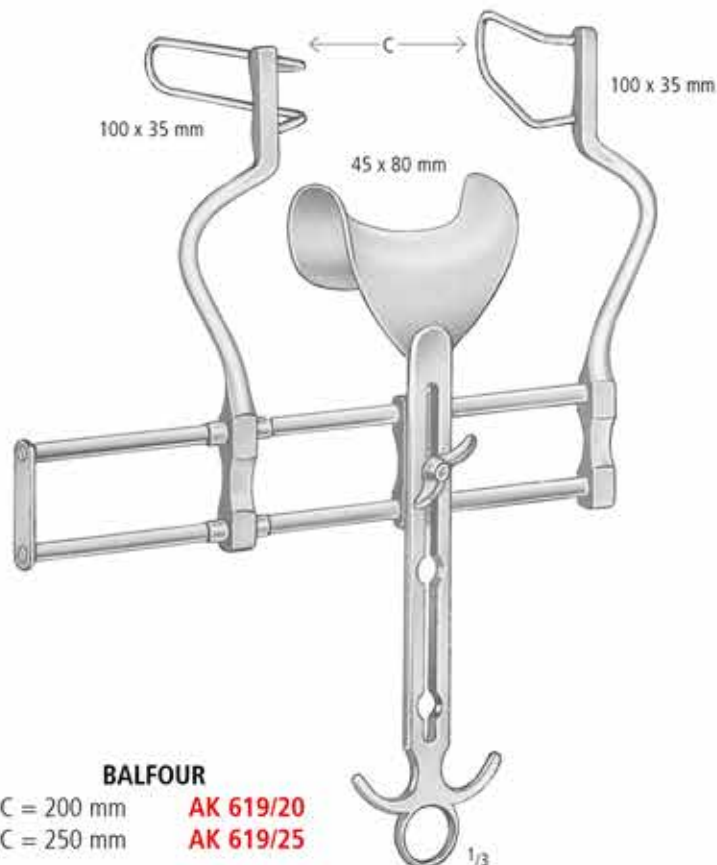

BALFOUR

C = 200 mm **AK 619/20**
C = 250 mm **AK 619/25**

AA
AB
AC
AD
AE
AF
AK
AL
AM
AO
AP
AR
KA
KD
KU
KY

AK WUNDHAKEN RETRACTORS SEPARADORES ECARTEURS DIVARICATORI

Bauchdeckenhalter
Abdominal Retractors
Separadores abdominales
Ecarteurs abdominaux
Divaricatori addominali

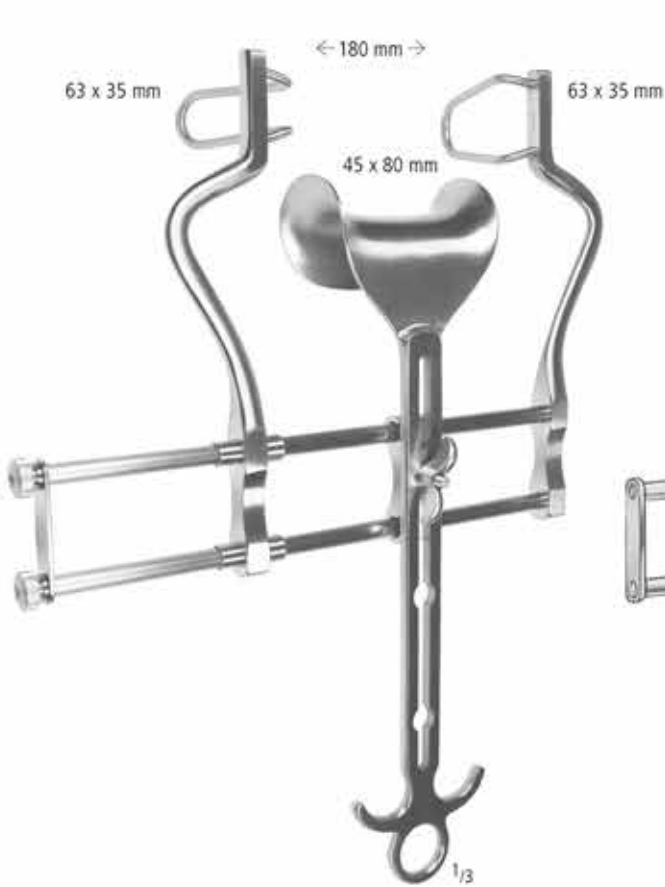

BALFOUR
AK 620/18

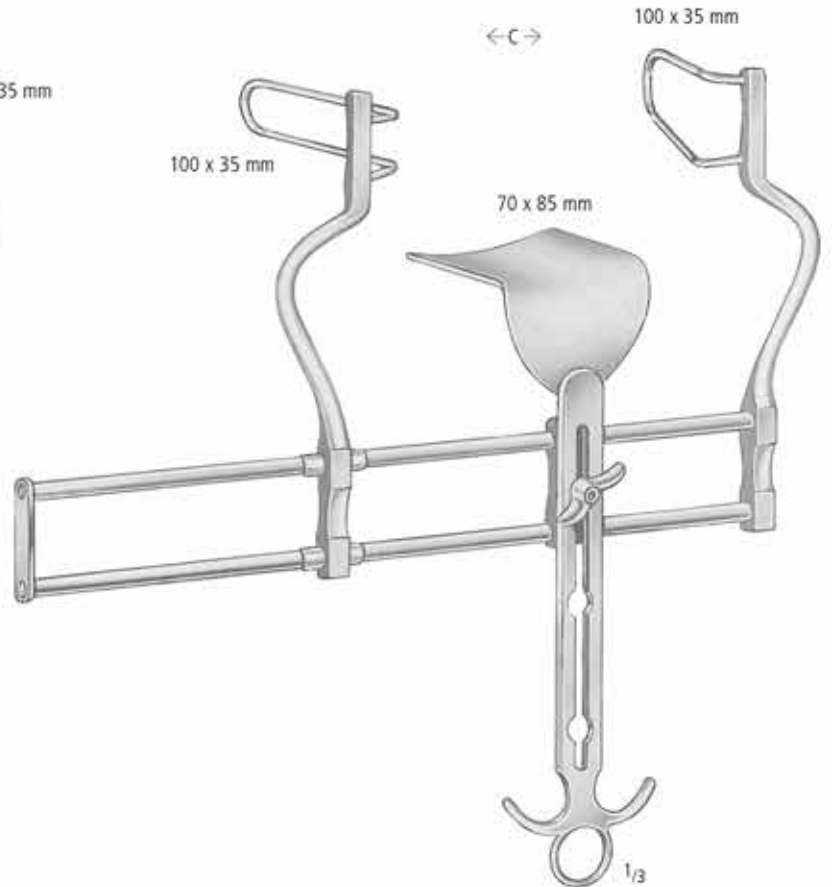

BALFOUR
C = 200 mm **AK 620/20**
C = 250 mm **AK 620/25**



AK 621/50
AK 621/70



BALFOUR
45 x 80 mm **AK 622/01**
70 x 85 mm **AK 622/02**

WUNDHAKEN RETRACTORS SEPARADORES ECARTEURS DIVARICATORI

Bauchdeckenhalter
Abdominal Retractors
Separadores abdominales
Ecarteurs abdominaux
Divaricatori addominali

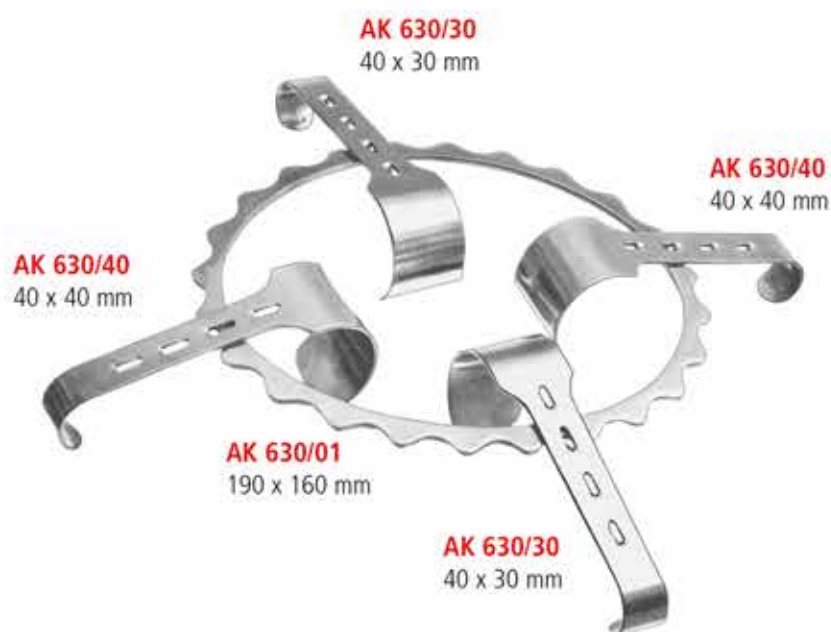

DENIS BROWNE

AK 630/00 = 1 x **AK 630/01**
2 x **AK 630/30**
2 x **AK 630/40**



AK 632/01



110 x 70 mm
AK 632/02



80 x 45 mm
AK 632/03

O'SULLIVAN-O'CONNOR

AK 632/00 = 1 x **AK 632/01**
1 x **AK 632/02**
2 x **AK 632/03**

AA
AB
AC
AD
AE
AF
AK
AL
AM
AO
AP
AR
KA
KD
KU
KY

AK WUNDHAKEN RETRACTORS SEPARADORES ECARTEURS DIVARICATORI

Bauchdeckenhalter
Abdominal Retractors
Separadores abdominales
Ecarteurs abdominaux
Divaricatori addominali



DOYEN
28,0 cm/11"

- 55 x 95 mm **AK 645/01**
- 55 x 105 mm **AK 645/02**
- 55 x 115 mm **AK 645/03**
- 55 x 125 mm **AK 645/04**

AK 650/01
300 x 300 mm



AK 650/38
38 x 60 mm



AK 650/50
50 x 65 mm

AK 650/50
50 x 65 mm

AK 650/38
38 x 60 mm

AK 655/45
45 x 80 mm



FRANZ
AK 650/00 = 1 x **AK 650/01**
+ 2 x **AK 650/38**
+ 2 x **AK 650/50**



AK 655/60
60 x 85 mm



AK 655/60
60 x 85 mm



FRANZ
AK 655/00 = 1 x **AK 650/01**
+ 2 x **AK 650/38**
+ 2 x **AK 650/50**
+ 2 x **AK 655/45**
+ 2 x **AK 655/60**

AK 655/45
45 x 80 mm



AK 656/35
105 x 35 mm



AK 656/50
98 x 50 mm

WUNDHAKEN RETRACTORS SEPARADORES ECARTEURS DIVARICATORI

Bauchdeckenhalter
Abdominal Retractors
Separadores abdominales
Ecarteurs abdominaux
Divaricatori addominali



KIRSCHNER

AK 660/00 = 1 x **AK 660/01**
2 x **AK 660/40**
2 x **AK 660/50**

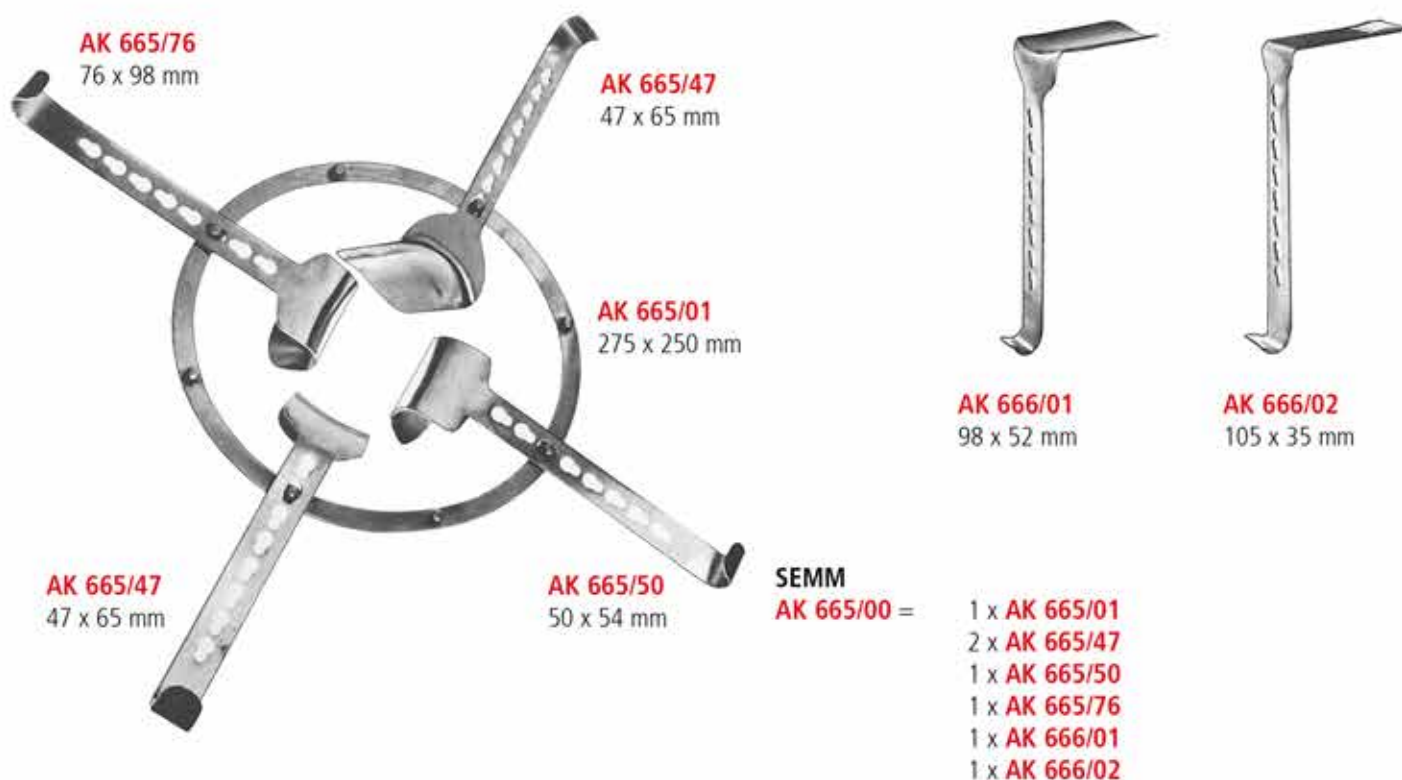

SEMM

AK 665/00 = 1 x **AK 665/01**
2 x **AK 665/47**
1 x **AK 665/50**
1 x **AK 665/76**
1 x **AK 666/01**
1 x **AK 666/02**

AA
AB
AC
AD
AE
AF
AK
AL
AM
AO
AP
AR
KA
KD
KU
KY

Bauchdeckenhalter
 Abdominal Retractors
 Separadores abdominales
 Ecarteurs abdominaux
 Divaricatori addominali

AK 700/23
 23 x 44 mm



AK 700/30
 30 x 44 mm



komplett
 complete
 completo
 complet
 completo

COLLIN-BABY
AK 700/00
 18,0 cm/7"

← 165 mm →



AK 702/16
AK 704/16

COLLIN

S
 50 x 58 mm
 62 x 80 mm

M
 62 x 67 mm
 62 x 67 mm

WUNDHAKEN RETRACTORS SEPARADORES ECARTEURS DIVARICATORI

Bauchdeckenhalter
 Abdominal Retractors
 Separadores abdominales
 Ecarteurs abdominaux
 Divaricatori addominali

AA
 AB
 AC
 AD
 AE
 AF
AK
 AL
 AM
 AO
 AP
 AR
 KA
 KD
 KU
 KY

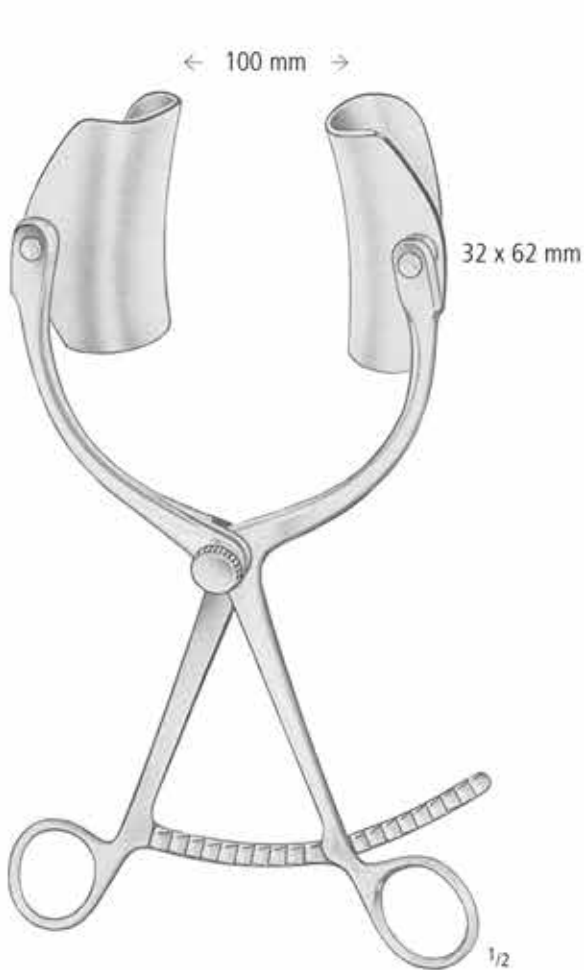

COLLIN
AK 706/10
 22,0 cm/8³/₄"

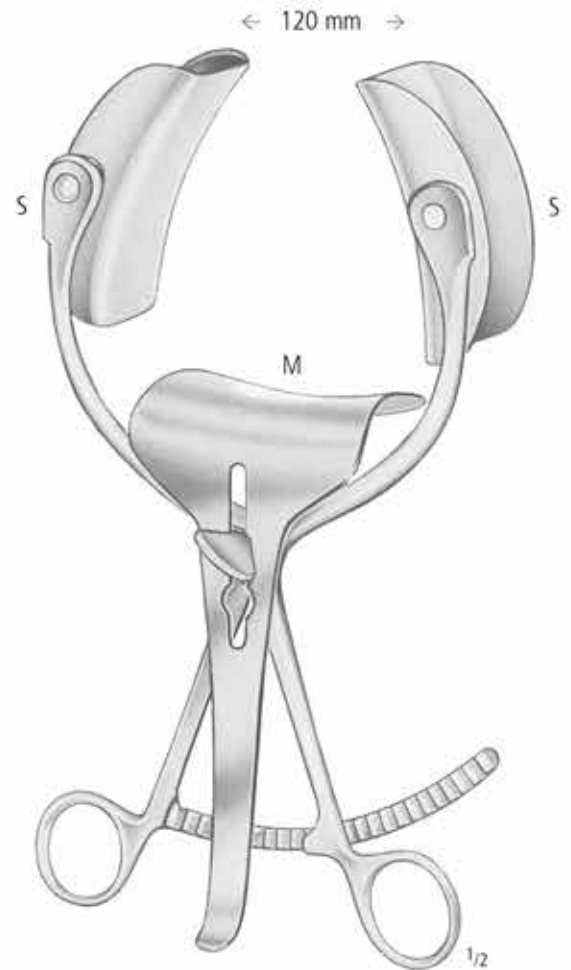

COLLIN

	S	M
AK 708/12	38 x 62 mm	55 x 55 mm
AK 709/12	38 x 80 mm	55 x 65 mm
AK 710/12	38 x 100 mm	55 x 75 mm

Bauchdeckenhalter
 Abdominal Retractors
 Separadores abdominales
 Ecarteurs abdominaux
 Divaricatori addominali

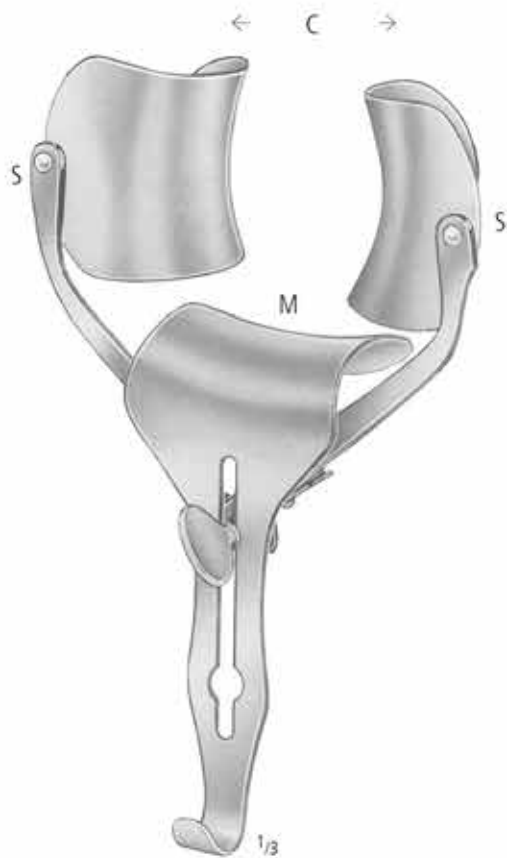

RICARD

	S	M	C
AK 712/28	72 x 85 mm	80 x 90 mm	280 mm
AK 712/30	60 x 80 mm	55 x 70 mm	300 mm

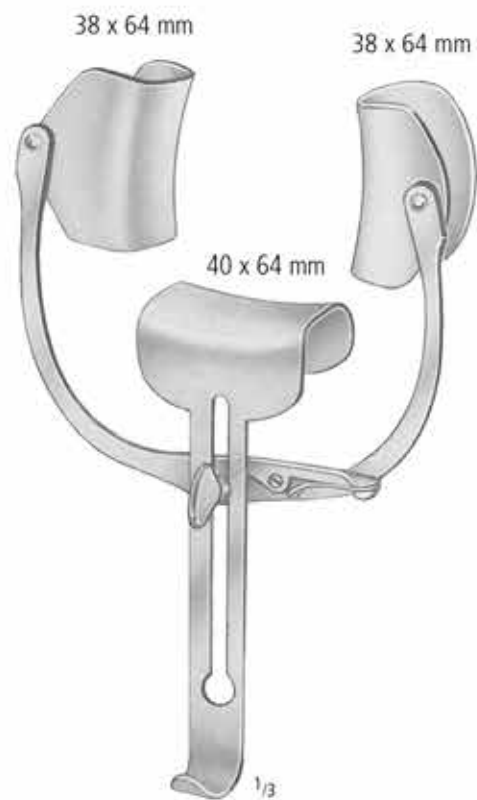

ROBIN-MASSE

AK 715/00

WUNDHAKEN RETRACTORS SEPARADORES ECARTEURS DIVARICATORI

Bauchdeckenhalter
Abdominal Retractors
Separadores abdominales
Ecarteurs abdominaux
Divaricatori addominali



38 x 62 mm **AK 725/06**
38 x 80 mm **AK 725/08**
38 x 100 mm **AK 725/10**

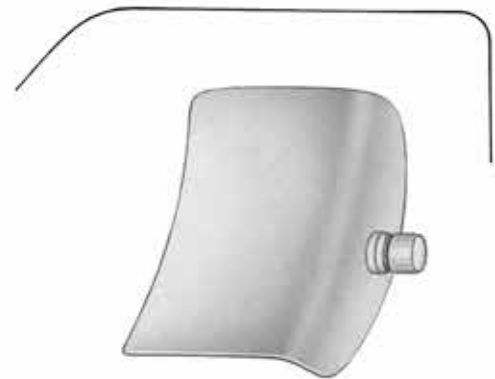

AK 726/80
62 x 80 mm

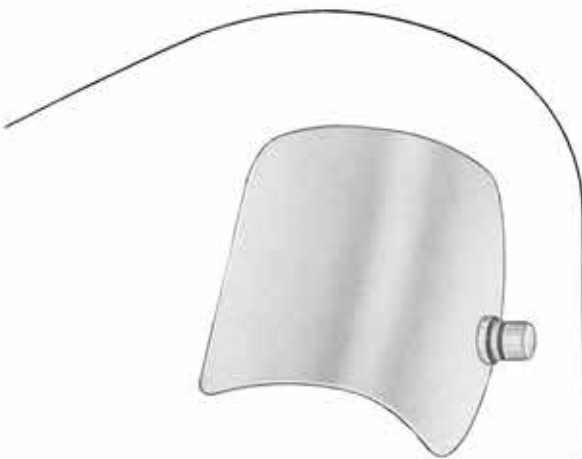

50 x 58 mm **AK 727/58**
60 x 80 mm **AK 727/80**
72 x 85 mm **AK 727/85**

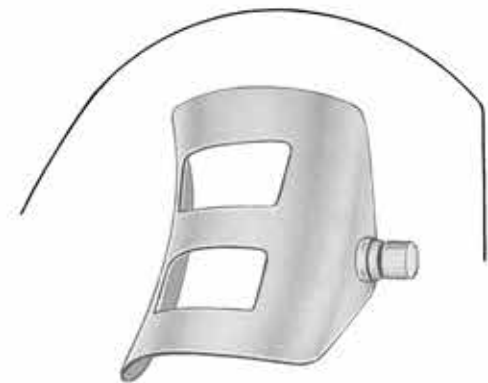

AK 728/80
62 x 80 mm

AA
AB
AC
AD
AE
AF
AK
AL
AM
AO
AP
AR
KA
KD
KU
KY

AK WUNDHAKEN RETRACTORS SEPARADORES ECARTEURS DIVARICATORI

Bauchspatel
Abdominal Spatulas
Espátulas abdominales
Spatules abdominales
Spatole addominali

biegsam
malleable
maleables
malléables
malleabili



200 x 12 mm **AK 800/12**
200 x 17 mm **AK 800/17**
200 x 25 mm **AK 800/25**
250 x 25 mm **AK 802/25**

biegsam
malleable
maleables
malléables
malleabili



33,0 cm/13"

30 mm **AK 804/30**
40 mm **AK 804/40**
50 mm **AK 804/50**

biegsam
malleable
maleables
malléables
malleabili



25 mm

20,0 cm/8"

17 mm

TUFFIER
AK 805/20

biegsam
malleable
maleables
malléables
malleabili

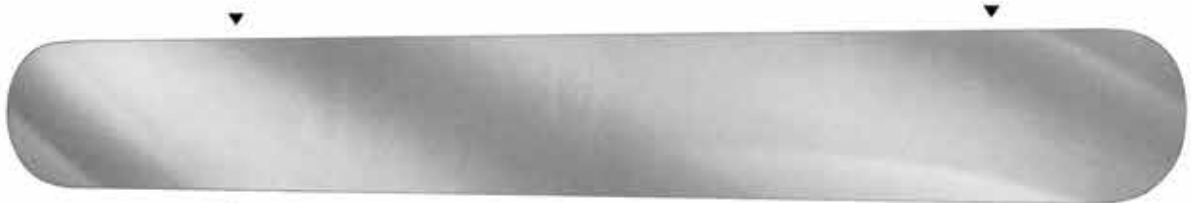

HABERER

25/30 mm 28,0 cm/11" **AK 807/30**
37/45 mm 30,0 cm/12" **AK 807/45**
40/50 mm 30,0 cm/12" **AK 807/50**

45 mm



REVERDIN
AK 809/29

29,0 cm/11½"

60 mm

SONDEN
PROBES
SONDAS
SONDES
SONDE

AL

nopa[®] instruments



AL SONDEN PROBES SONDAS SONDES SONDE

Sonden
Probes
Sondas
Sondes
Sonde



Silber
silver
de plata
en argent
d'argento



11,5 cm/4 1/2"
13,0 cm/5"
14,5 cm/5 3/4"
16,0 cm/6 1/4"
18,0 cm/7"
20,0 cm/8"
25,0 cm/10"

1,0 mm	1,5 mm	2,0 mm
AL 001/11	AL 001/41	AL 002/11
AL 001/13	AL 001/43	AL 002/13
AL 001/14	AL 001/44	AL 002/14
AL 001/16	AL 001/46	AL 002/16
AL 001/18	AL 001/48	AL 002/18
AL 001/20	AL 001/50	AL 002/20
AL 001/25	AL 001/55	AL 002/25

MYRTLE LEAF

AL 003/11
AL 003/13
AL 003/14
AL 003/16
AL 003/18
AL 003/20
AL 003/25

STACKE
AL 013/10
10,5 cm/4 1/4"
Ø 1,0 mm



DOYEN

AL 017/14

NELATON

AL 022/16

11,5 cm/4 1/2"
13,0 cm/5"
14,5 cm/5 3/4"
16,0 cm/6 1/4"
18,0 cm/7"
20,0 cm/8"

AL 015/11
AL 015/13
AL 015/14
AL 015/16
AL 015/18
AL 015/20

AL 020/11
AL 020/13
AL 020/14
AL 020/16
AL 020/18

SONDEN PROBES SONDAS SONDES SONDE

Sonden und Watteträger
 Probes and Cotton Applicators
 Sondas y Porta-algodones
 Sondes et Porte-coton
 Sonde e Portacotone

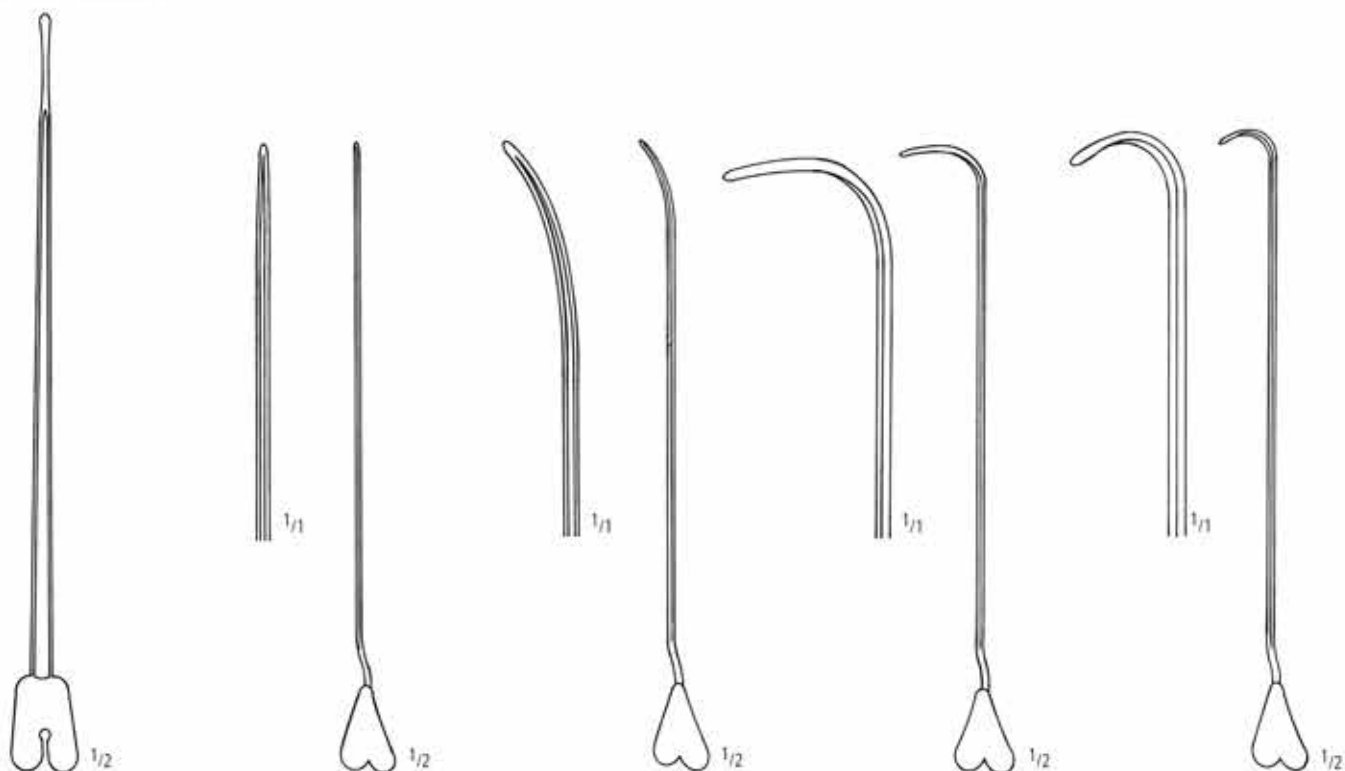

BRODIE
 AL 026/20
 20,0 cm/8"

LOCKHART-MUMMERY
 Fig. 1
 AL 030/01

Fig. 2
 AL 030/02

LOCKHART-MUMMERY
 Fig. 3
 AL 030/03

Fig. 4
 AL 030/04

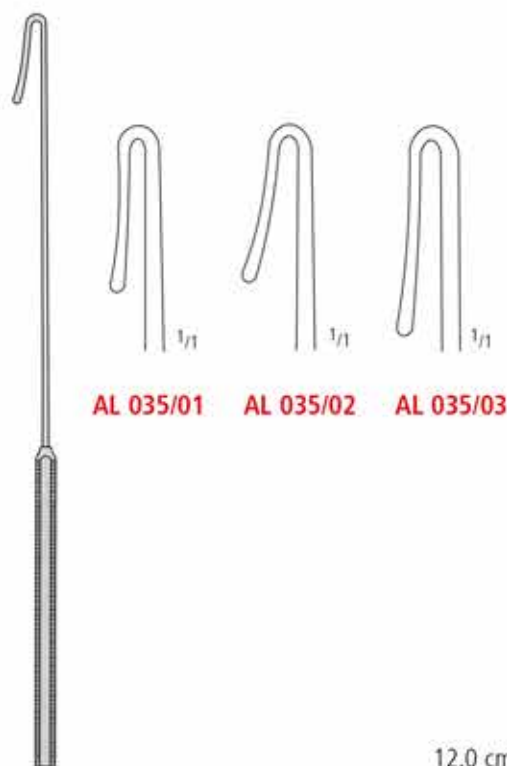

AL 035/01

AL 035/02

AL 035/03

PRATT
 21,0 cm/8 1/4"



FARRELL

0,9 mm
 1,1 mm
 1,2 mm
 12,0 cm/4 3/4"
 14,0 cm/5 1/2"
 16,5 cm/6 1/2"
 18,0 cm/7"

AL 100/12

AL 100/14

AL 100/16

AL 100/18



FARRELL

0,9 mm
 1,1 mm
 1,2 mm
 12,0 cm/4 3/4"
 14,0 cm/5 1/2"
 16,5 cm/6 1/2"
 18,0 cm/7"

AL 120/12

AL 120/14

AL 120/16

AL 120/18

AA
 AB
 AC
 AD
 AE
 AF
 AG
 AH
 AI
 AJ
 AK
 AL
 AM
 AN
 AO
 AP
 AQ
 AR
 AS
 AT
 AU
 AV
 AW
 AX
 AY
 AZ

AL SONDEN PROBES SONDAS SONDES SONDE

Watteträger und Krampfader-Besteck
 Cotton Applicators and Varicose Vein Probe Set
 Porta-algodones y sonda para várices
 Porte-coton et trousse à varices
 Portacotone e astuccio per varici



UCKERMANN
AL 160/16
 16,0 cm/6 1/4"

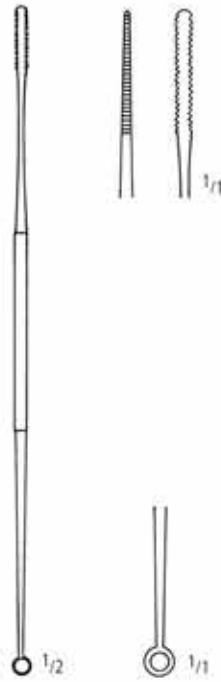

JOBSON-HORNE
AL 162/18
 18,0 cm/7"

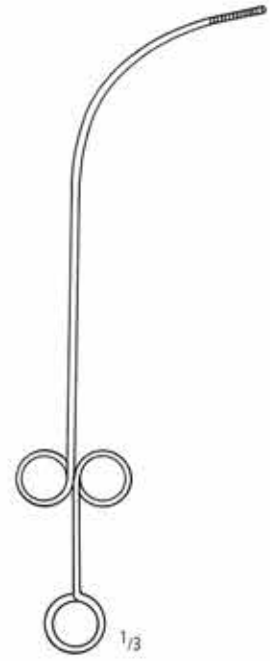

FEIN
AL 170/28
 28,0 cm/11"



3,0 mm
AL 182/03



6,0 mm
AL 182/06



9,0 mm
AL 182/09



12,0 mm
AL 182/12

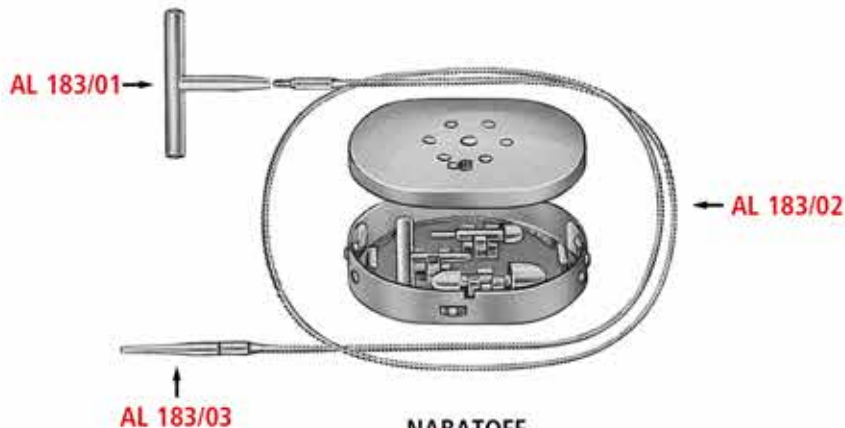

NABATOFF
AL 180/00

komplett-complete-completo-complet-completo

SONDEN PROBES SONDAS SONDES SONDE

Gefäß-Dilatatoren
Vascular Dilators
Dilatadores vasculares
Dilatateurs vasculaires
Dilatatori per vasi



biegsam
malleable
maleables
malléables
malleabili

GARRETT

	14,0 cm/5 1/2"	21,0 cm/8 1/4"
1,0 mm	AL 190/10	AL 192/10
1,5 mm	AL 190/15	AL 192/15
2,0 mm	AL 190/20	AL 192/20
2,5 mm	AL 190/25	AL 192/25
3,0 mm	AL 190/30	AL 192/30
3,5 mm	AL 190/35	AL 192/35
4,0 mm	AL 190/40	AL 192/40
4,5 mm	AL 190/45	AL 192/45
5,0 mm	AL 190/50	AL 192/50

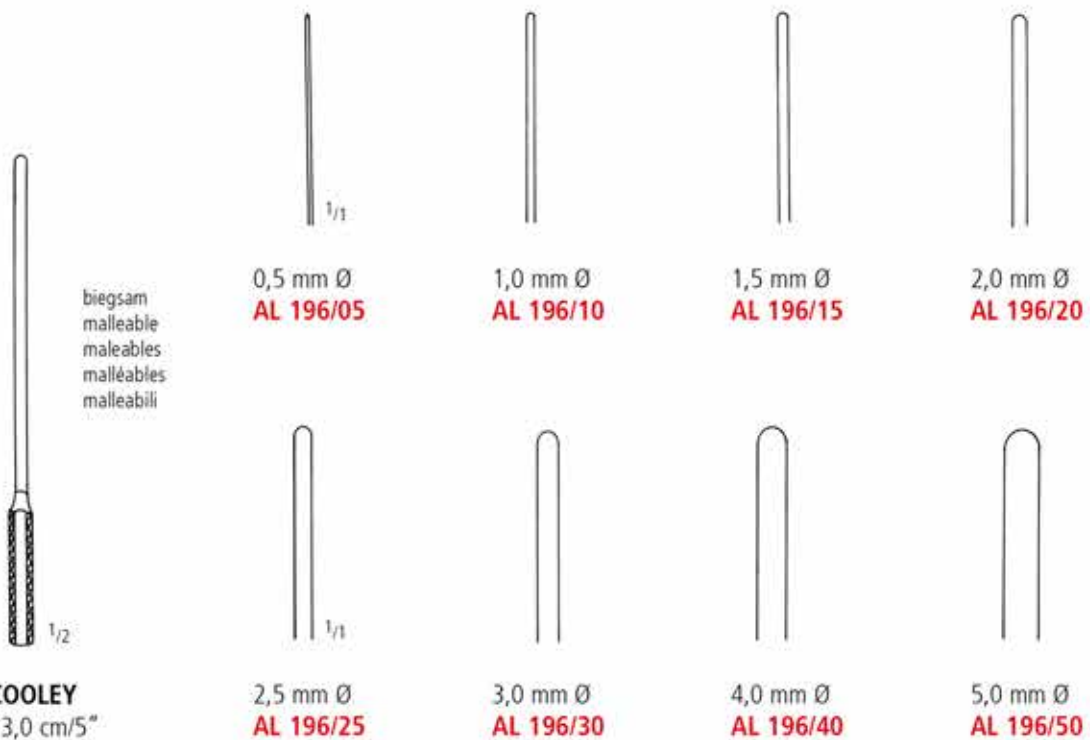

biegsam
malleable
maleables
malléables
malleabili

COOLEY
13,0 cm/5"

0,5 mm Ø
AL 196/05

1,0 mm Ø
AL 196/10

1,5 mm Ø
AL 196/15

2,0 mm Ø
AL 196/20

2,5 mm Ø
AL 196/25

3,0 mm Ø
AL 196/30

4,0 mm Ø
AL 196/40

5,0 mm Ø
AL 196/50

AA
AB
AC
AD
AE
AF
AK
AL
AM
AO
AP
AR
KA
KD
KU
KY

AL SONDEN PROBES SONDAS SONDES SONDE

Gefäß-Dilatatoren
 Vascular Dilators
 Dilatadores vasculares
 Dilatateurs vasculaires
 Dilatatori per vasi



DE BAKEY

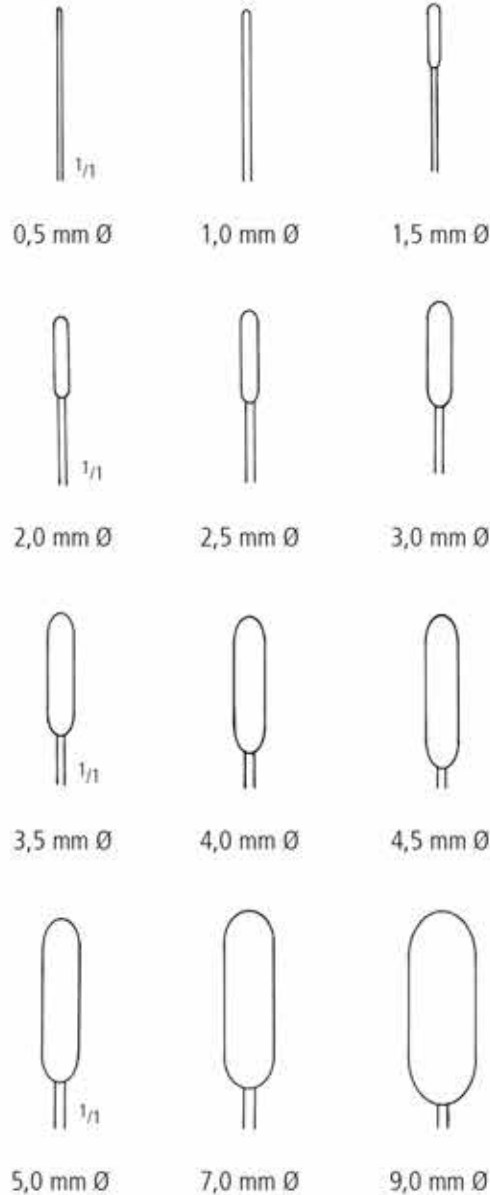

biegsam-malleable-maleables-malléables-malleabili

mm Ø	19,0 cm / 7 1/2"	35,0 cm / 14"
0,5	AL 200/05	AL 201/05
1,0	AL 200/10	AL 201/10
1,5	AL 200/15	AL 201/15
2,0	AL 200/20	AL 201/20
2,5	AL 200/25	AL 201/25
3,0	AL 200/30	AL 201/30
3,5	AL 200/35	AL 201/35
4,0	AL 200/40	AL 201/40
4,5	AL 200/45	AL 201/45
5,0	AL 200/50	AL 201/50
7,0	AL 200/70	AL 201/70
9,0	AL 200/90	AL 201/90

SONDEN PROBES SONDAS SONDES SONDE

Gefäß-Stripper
 Vascular Strippers
 Desobliteradores de vasos
 Tire-veines
 Tiravene



 1/1
 2,0 mm
AL 220/02

 3,0 mm
AL 220/03

 4,0 mm
AL 220/04

 1/1
 6,0 mm
AL 220/06

 7,0 mm
AL 220/07

 8,5 mm
AL 220/08

 1/1
 10,0 mm
AL 220/10

 12,0 mm
AL 220/12

 14,0 mm
AL 220/14



AL 222/12
 12,0 cm / 4³/₄\"/>

AA
 AB
 AC
 AD
 AE
 AF
 AG
AL
 AM
 AN
 AO
 AP
 AR
 AS
 AT
 AU
 AV
 AW
 AX
 AY
 AZ

Fasszangen
 Grasping Forceps
 Pinzas para coger
 Pincés pour saisir
 Pinze per afferrare



33,0 cm / 13"

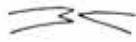

AL 250/33

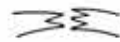

AL 251/33



AL 252/33

VERBAND
DRESSING
VENDAJES
PANSEMENTS
BENDAGGI

AM

nopa[®] instruments





HOPKINS
AM 030/20
20,0 cm/8"



ESMARCH
AM 038/18
18,0 cm/7"



REINER
AM 040/18
18,5 cm/7¹/₃"



WIGMORE
AM 044/19
19,0 cm/7¹/₂"



ENGEL
AM 060/14
14,0 cm/5¹/₂"



BERGMANN
AM 062/18
18,0 cm/7"



HENNIG
AM 100/28
28,0 cm/11"



BEESON
AM 102/30
30,0 cm/12"



MOD. USA
AM 120/23
23,0 cm/9"



WOLFF
 18,0 cm / 7" **AM 200/18**
 24,0 cm / 9½" **AM 200/24**



STILLE
 20,0 cm / 8" **AM 250/20**
 23,0 cm / 9" **AM 250/23**
 26,0 cm / 10½" **AM 250/26**
 37,0 cm / 14½" **AM 250/37**

OSCI nopa®



- AM 300/00** = 230 V / 500 W
 (+ **AM 308/50** + **AM 308/65** + **AM 312/23**)
 Euro-Flachstecker / EU-plug
- AM 300/01** = 110 V / 500 W
 (+ **AM 308/50** + **AM 308/65** + **AM 312/23**)
 USA-Stecker / USA-plug

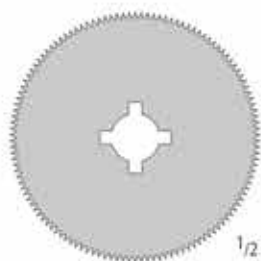

Für Hartverband
 For hard plaster
 Para yeso duro
 Pour plâtre dur
 per bendaggi gessati

- AM 308/50** = 50 mm Ø
AM 308/65 = 65 mm Ø



AM 312/23

nopa[®] BluePower

- AM 301/00** = 230 V
 (+ **AM 308/50** + **AM 308/65** + **AM 312/23**)
 Euro-Flachstecker / EU-plug
- AM 301/01** = 120 V
 (+ **AM 308/50** + **AM 308/65** + **AM 312/23**)
 USA-Stecker / USA-plug

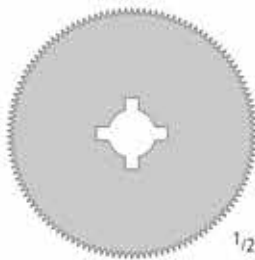

Für Hartverband
 For hard plaster
 Para yeso duro
 Pour plâtre dur
 per bendaggi gessati

- AM 308/50** = 50 mm Ø
AM 308/65 = 65 mm Ø

**AM 312/23**

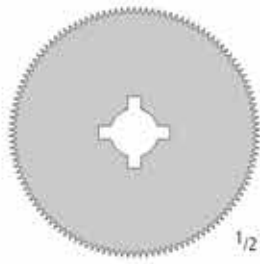

Für Hartverband
For hard plaster
Para yeso duro
Pour plâtre dur
per bendaggi gessati

AM 308/45 = Ø 45 mm
AM 308/50 = Ø 50 mm
AM 308/65 = Ø 65 mm

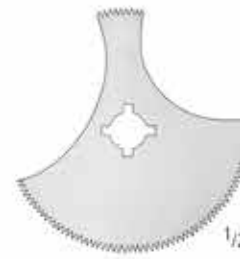

AM 308/70

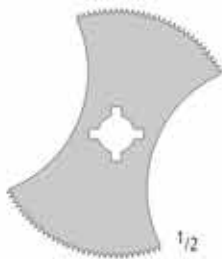

AM 308/71 = Ø 65 mm



AM 308/72 = 8 mm



AM 308/73 = 20 mm



AM 308/80

AA
AB
AC
AD
AE
AF
AK
AL
AM
AO
AP
AR
KA
KD
KU
KY

vacu nopa[®] (Absaugung)
(vacuum cleaner)



AM 350/00 = 230 V
AM 350/01 = 120 V

PUNKTION/KANÜLEN
PUNCTURE/SPECIAL NEEDLES
PUNCION/AGUJAS ESPECIALES
PONCTION/AIGUILLES SPECIALES
PUNTURA/AGHI SPECIALI

A0

nopa[®] instruments



Trokare
Trocars
Trócares
Trocarts
Trequarti

AA
AB
AC
AD
AE
AF
AG
AH
AI
AJ
AK
AL
AM
AO
AP
AR
AS
AT
AU
AV
AW
AX
AY
AZ



SINUSCOPY

L (mm) Ø 6,0 mm
85 **AO 080/01**



SINUSCOPY

L (mm) Ø 4,5 mm Ø 6,0 mm
85 AO 080/10 **AO 080/25**



UNIVERSAL

AO 110/04
Satz zu 4 Stück
Set of 4 pieces
Juego de 4 piezas
Jeu de 4 pièces
Serie da 4 pezzi



STANDARD

Ø 3 mm **AO 120/30**
Ø 4 mm **AO 120/40**
Ø 5 mm **AO 120/50**
Ø 6 mm **AO 120/60**

Saugrohre
Suction Tubes
Tubos de aspiración
Canules d'aspiration
Cannule per aspirazione

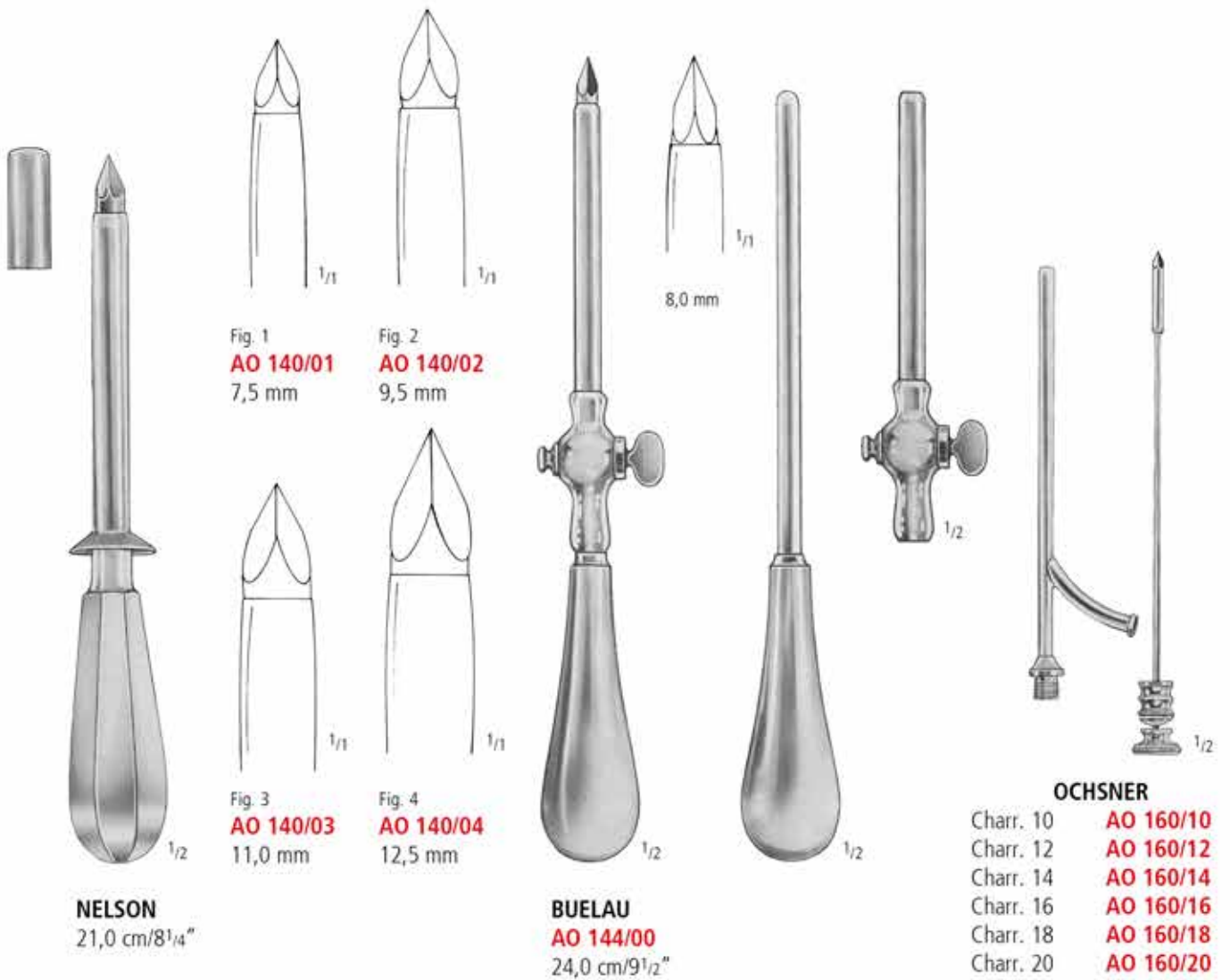



YANKAUER
AO 400/00
 27,0 cm/10³/₄"



WALTON-YANKAUER
AO 404/00
 32,5 cm/13"



ANDREWS-PYNCHON
AO 406/00
 23,5 cm/9¹/₃"



DE BAKEY
AO 408/00
 27,5 cm/10³/₄"

AA
 AB
 AC
 AD
 AE
 AF
 AG
 AH
 AI
 AJ
 AK
 AL
 AM
AO
 AP
 AR
 AS
 AT
 AU
 AV
 AW
 AX
 AY
 AZ

Saugrohre
Suction Tubes
Tubos de aspiración
Canules d'aspiration
Cannule per aspirazione



COUPLAND
AO 410/00



POOLE
AO 420/22
10,0 mm



POOLE
AO 421/22
8,0 mm



BABY-POOLE
AO 422/20
5,5 mm

Saugrohre
Suction Tubes
Tubos de aspiración
Canules d'aspiration
Cannule per aspirazione

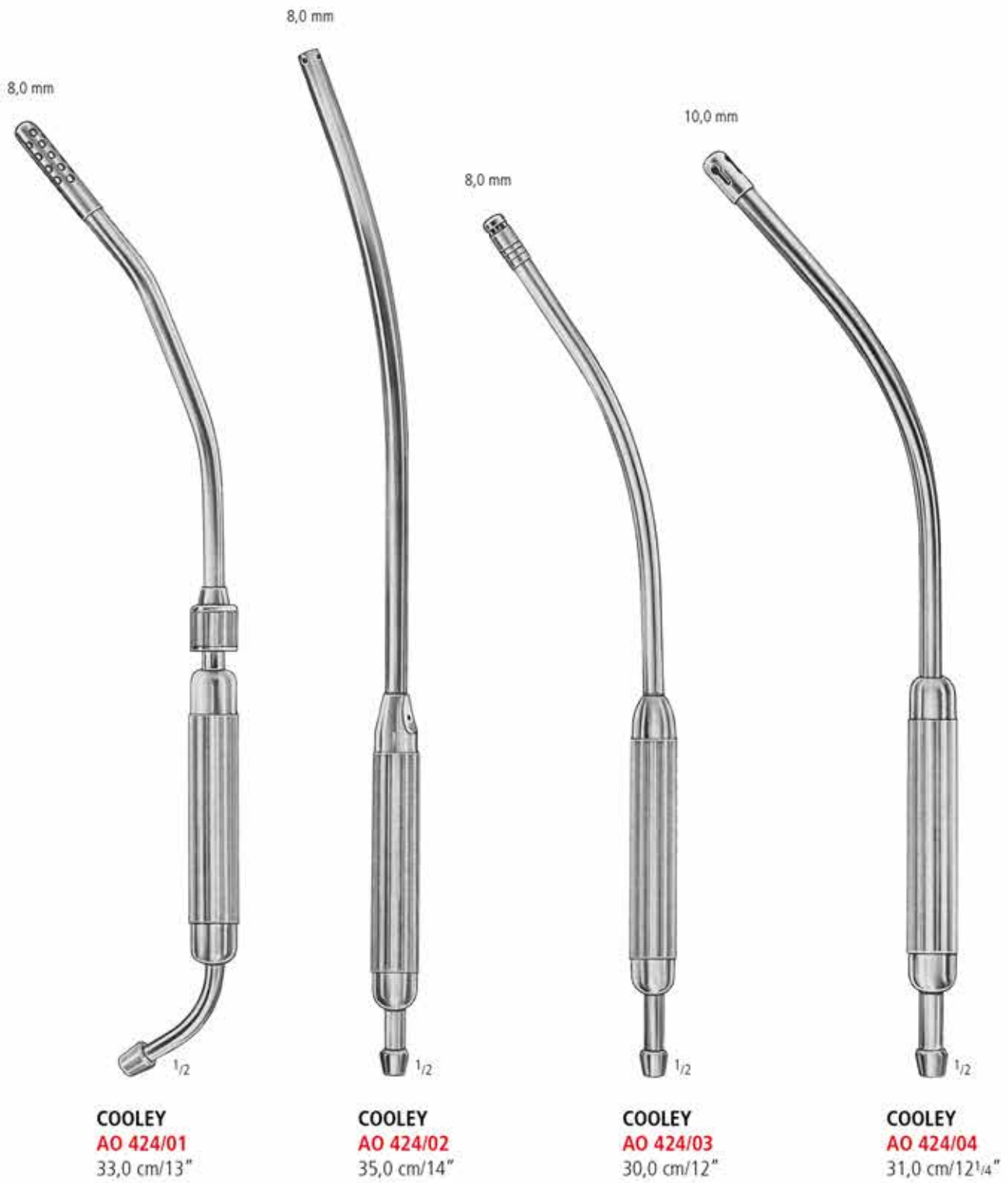

AA
AB
AC
AD
AE
AF
AG
AH
AI
AJ
AK
AL
AM
AN
AO
AP
AQ
AR
AS
AT
AU
AV
AW
AX
AY
AZ



Saugrohre
Suction Tubes
Tubos de aspiración
Canules d'aspiration
Cannule per aspirazione

complete with suction tube
+ cannula 0,5 mm
+ cannula 0,7 mm
+ cannula 0,9 mm



FRAZIER

- 6 Charr. **AO 430/06**
- 7 Charr. **AO 430/07**
- 8 Charr. **AO 430/08**
- 9 Charr. **AO 430/09**
- 10 Charr. **AO 430/10**
- 11 Charr. **AO 430/11**
- 12 Charr. **AO 430/12**
- 15 Charr. **AO 430/15**

PLESTER

- 1,5 mm **AO 432/15**
- 2,0 mm **AO 432/20**
- 2,5 mm **AO 432/25**
- 3,0 mm **AO 432/30**

FERGUSSON

- 5 Charr. **AO 434/05**
- 6 Charr. **AO 434/06**
- 7 Charr. **AO 434/07**
- 8 Charr. **AO 434/08**
- 9 Charr. **AO 434/09**
- 10 Charr. **AO 434/10**
- 12 Charr. **AO 434/12**

EICKEN-KILLIAN

- AO 436/03**
- 13,0 cm/5"
- Ø 3 mm

WULLSTEIN MICRO

- AO 438/00**



	L	L	L	L
	130 mm	150 mm	180 mm	220 mm
Ø 1,5 mm	AO 440/13	AO 440/15	AO 440/18	AO 440/22
Ø 2,0 mm	AO 441/13	AO 441/15	AO 441/18	AO 441/22
Ø 2,5 mm	AO 442/13	AO 442/15	AO 442/18	AO 442/22
Ø 3,5 mm	AO 443/13	AO 443/15	AO 443/18	AO 443/22



ADSON
AO 450/04
21,0 cm/8¹/₄"
Ø 4,0 mm

AA
AB
AC
AD
AE
AF
AG
AH
AI
AJ
AK
AL
AM
AN
AO
AP
AQ
AR
AS
AT
AU
AV
AW
AX
AY
AZ

Saugrohre
Suction Tubes
Tubos de aspiración
Canules d'aspiration
Cannule per aspirazione



COGSWELL
AO 460/20
24,5 cm/9³/₄"
2,0 mm Ø



LUER
L = 110 mm



AO 461/30
Ø 3,0 mm



AO 461/35
Ø 3,5 mm

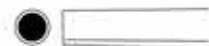

AO 461/45
Ø 4,5 mm

Saugrohre
Suction Tubes
Tubos de aspiración
Canules d'aspiration
Cannule per aspirazione



A=Ø 4,0 mm
14,0 cm
18,0 cm

A=Ø 6,0 mm
AO 463/03
AO 464/03

Länge/length
AO 463/04
AO 464/04

A=Ø 3,0 mm
AO 463/06
AO 464/06



COUPLAND
AO 465/01
16,5 cm/6 1/2"



Fig. 1 **AO 466/01** A=Ø = 1,5 mm
Fig. 2 **AO 466/02** A=Ø = 2,0 mm
Fig. 3 **AO 466/03** A=Ø = 2,5 mm
Fig. 4 **AO 466/04** A=Ø = 3,5 mm

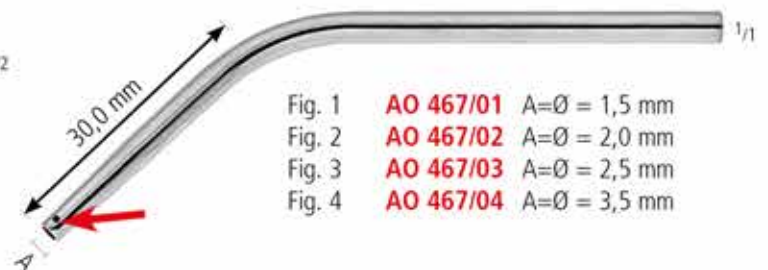

Fig. 1 **AO 467/01** A=Ø = 1,5 mm
Fig. 2 **AO 467/02** A=Ø = 2,0 mm
Fig. 3 **AO 467/03** A=Ø = 2,5 mm
Fig. 4 **AO 467/04** A=Ø = 3,5 mm

AA
AB
AC
AD
AE
AF
AK
AL
AM
AO
AP
AR
KA
KD
KU
KY

Führungsnadeln
 Guide Needles
 Agujas de guía
 Aiguilles d'introduction
 Aghi per introduzione



Charr./Fr.

8 **AO 820/08**
 10 **AO 820/10**
 12 **AO 820/12**
 14 **AO 820/14**
 16 **AO 820/16**
 18 **AO 820/18**

AO 821/08
AO 821/10
AO 821/12
AO 821/14
AO 821/16
AO 821/18

AO 822/08
AO 822/10
AO 822/12
AO 822/14
AO 822/16
AO 822/18

Ampullenspritzen
Cartridge Syringes
Jeringas para cartucho ampollas
Seringues à ampoule
Siringhe fiali



mit Aspiration
with aspiration
con aspiración
avec aspiration
con aspirazione

AO 861/18
1,8 ml



ohne Aspiration
without aspiration
sin aspiración
sans aspiration
senza aspirazione

AO 862/18
1,8 ml

stainless



mit Aspiration
with aspiration
con aspiración
avec aspiration
con aspirazione

AO 865/18
1,8 ml



AO 866/18
1,8 ml

AA
AB
AC
AD
AE
AF
AG
AH
AI
AJ
AK
AL
AM
AN
AO
AP
AQ
AR
AS
AT
AU
AV
AW
AX
AY
AZ

Spritzen
Syringes
Jeringas
Seringues
Siringhe



Glasspritze
50 ml **AO 869/05**



JANET
50 ml **AO 870/05**
100 ml **AO 870/10**
150 ml **AO 870/15**
200 ml **AO 870/20**



50 ml **AO 871/05**
100 ml **AO 871/10**
150 ml **AO 871/15**
200 ml **AO 871/20**



Einwegspritze
20 ml **AO 875/02**

Hähne und Verbindungsstücke
 Stopcocks and Connecting Pieces
 Llaves y Piezas de conexión
 Robinets et Raccords
 Rubinetti e Raccordi



AO 910/00



AO 911/00



AO 912/00



AO 913/00



AO 915/00



AO 916/00



AO 917/00



AO 918/00



AO 920/00

links
 left
 izquierda
 gauche
 sinistra

AO 921/01



rechts
 right
 derecha
 droite
 destra

AO 921/02



AO 922/00



AO 923/00



AO 924/00

AA
 AB
 AC
 AD
 AE
 AF
 AG
 AH
 AI
 AJ
 AK
 AL
 AM
 AN
 AO
 AP
 AR
 AS
 AT
 AU
 AV
 AW
 AX
 AY
 AZ

NARKOSE
ANAESTHESIA
ANESTESIA
ANESTHESIE
ANESTESIA

AP

nopa[®] instruments



Laryngoskope
Laryngoscopes
Laringoscopios
Laryngoscopes
Laringoscopi



AP 252/00
Fig. 0, 55 mm



AP 252/01
Fig. 1, 75 mm



AP 252/02
Fig. 2, 90 mm



AP 252/03
Fig. 3, 110 mm



AP 252/04
Fig. 4, 135 mm

McINTOSH

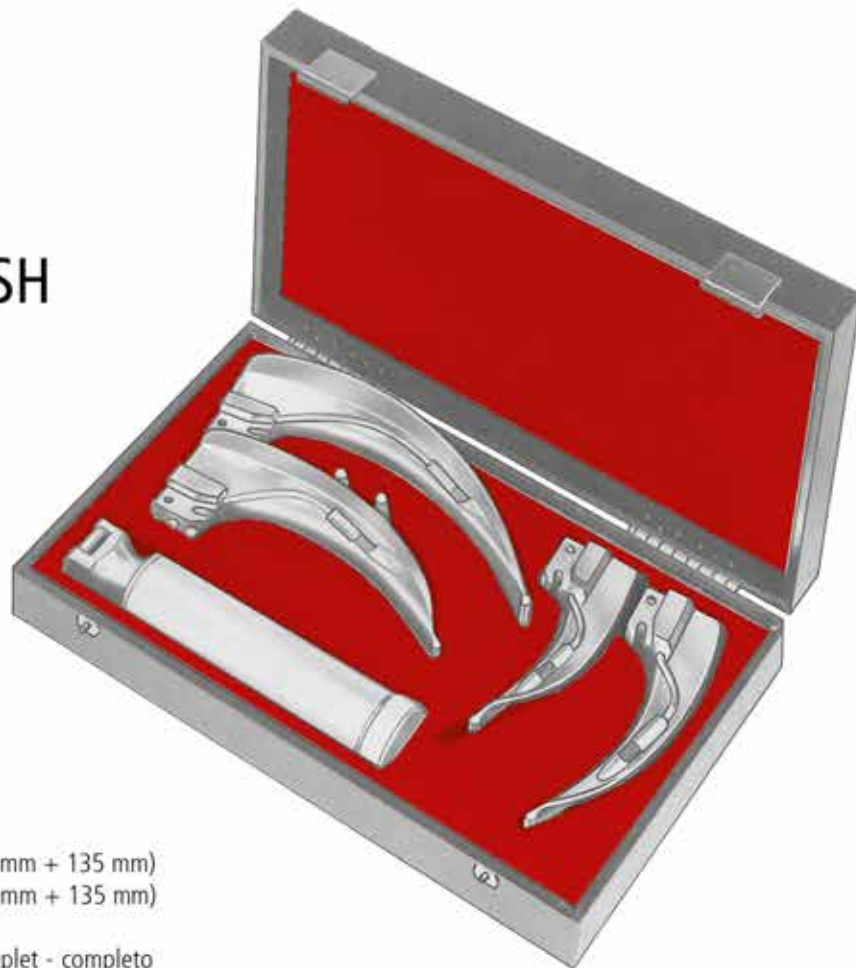

AP 250/00 (90 mm + 110 mm + 135 mm)

AP 250/01 (75 mm + 90 mm + 110 mm + 135 mm)

komplett - complete - completo - complet - completo

AA
AB
AC
AD
AE
AF
AK
AL
AM
AO
AP
AR
KA
KD
KU
KY

Laryngoskope
Laryngoscopes
Laringoscopios
Laryngoscopes
Laringoscopi



AP 262/00
Fig. 0, 70 mm



AP 262/01
Fig. 1, 95 mm



AP 262/02
Fig. 2, 110 mm



AP 262/03
Fig. 3, 140 mm



AP 262/04
Fig. 4, 170 mm



FOREGGER (WISCONSIN)



AP 260/00 (110 mm + 140 mm + 170 mm)

AP 260/01 (95 mm + 110 mm + 140 mm + 170 mm)

komplett - complete - completo - complet - completo

Laryngoskope
Laryngoscopes
Laringoscopios
Laryngoscopes
Laringoscopi



AP 272/00
Fig. 0, 55 mm



AP 272/01
Fig. 1, 80 mm



AP 272/02
Fig. 2, 130 mm



AP 272/03
Fig. 3, 170 mm



AP 272/04
Fig. 4, 180 mm



MILLER



AP 270/00 (130 mm + 170 mm + 180 mm)

AP 270/01 (80 mm + 130 mm + 170 mm + 180 mm)

komplett - complete - completo - complet - completo

AA
AB
AC
AD
AE
AF
AK
AL
AM
AO
AP
AR
KA
KD
KU
KY

Laryngoskope
Laryngoscopes
Laringoscopios
Laryngoscopes
Laringoscopi



AP 280/19
Ø 19 mm



AP 280/28
Ø 28 mm



AP 280/37
Ø 37 mm



AP 282/00
Fig. 2-4

AP 282/01
Fig. 2-4



AP 284/00
Fig. 0-1

AP 284/01
Fig. 0-1

Kaltlicht Laryngoskope
 Fibre Optic Laryngoscopes
 Laringoscopios con luz fría
 Laryngoscopes à lumière froide
 Laringoscopi a luce fredda

McINTOSH FIBRE OPTIC

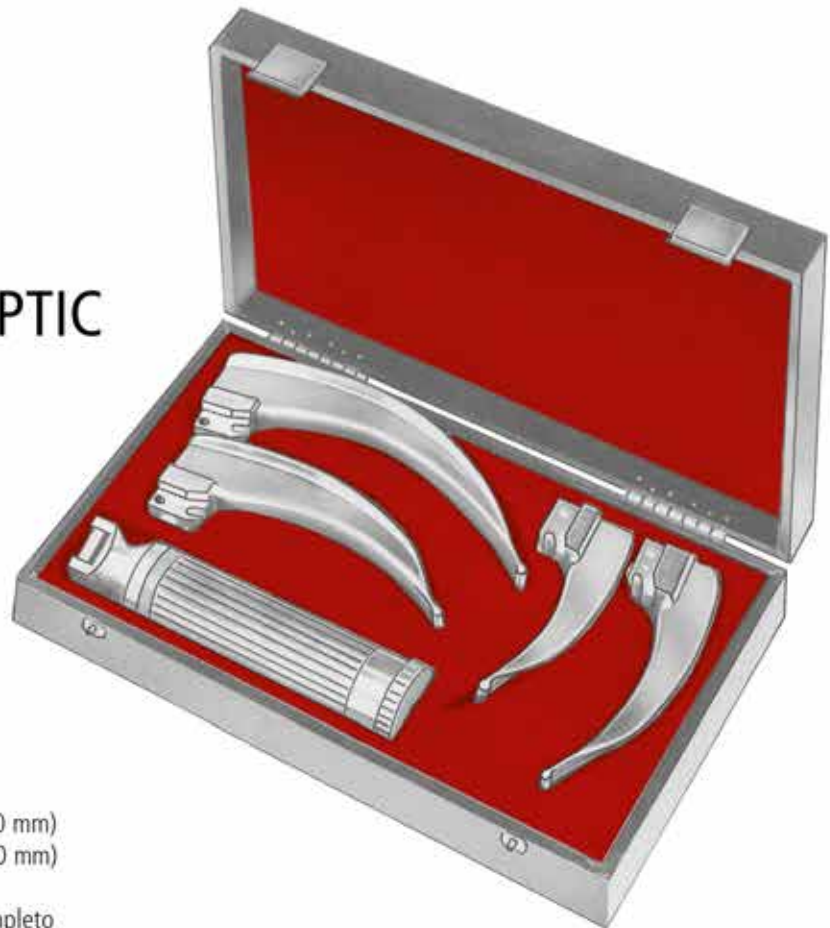

AP 300/00 (80 mm + 105 mm + 130 mm)
AP 300/01 (70 mm + 80 mm + 105 mm + 130 mm)

komplett - complete - completo - complet - completo



- | | | |
|---------|--------|------------------|
| Fig. 0, | 55 mm | AP 302/00 |
| Fig. 1, | 70 mm | AP 302/01 |
| Fig. 2, | 80 mm | AP 302/02 |
| Fig. 3, | 105 mm | AP 302/03 |
| Fig. 4, | 130 mm | AP 302/04 |
| Fig. 5, | 150 mm | AP 302/05 |

AA
AB
AC
AD
AE
AF
AG
AH
AI
AJ
AK
AL
AM
AN
AO
AP
AQ
AR
AS
AT
AU
AV
AW
AX
AY
AZ

Kaltlicht Laryngoskope
 Fibre Optic Laryngoscopes
 Laringoscopios con luz fría
 Laryngoscopes à lumière froide
 Laringoscopi a luce fredda

FOREGGER (WISCONSIN) FIBRE OPTIC



AP 310/00 (110 mm + 140 mm + 170 mm)
AP 310/01 (95 mm + 110 mm + 140 mm + 170 mm)

komplett - complete - completo - complet - completo



Fig. 00,	50 mm	AP 312/10
Fig. 0,	70 mm	AP 312/00
Fig. 1,	95 mm	AP 312/01
Fig. 2,	110 mm	AP 312/02
Fig. 3,	140 mm	AP 312/03
Fig. 4,	170 mm	AP 312/04

Kaltlicht Laryngoskope
 Fibre Optic Laryngoscopes
 Laringoscopios con luz fría
 Laryngoscopes à lumière froide
 Laringoscopi a luce fredda

MILLER FIBRE OPTIC



AP 320/00 (80 mm + 130 mm + 170 mm)
AP 320/01 (80 mm + 130 mm + 170 mm + 180 mm)

komplett - complete - completo - complet - completo



- | | | |
|---------|--------|------------------|
| Fig. 0, | 55 mm | AP 322/00 |
| Fig. 1, | 80 mm | AP 322/01 |
| Fig. 2, | 130 mm | AP 322/02 |
| Fig. 3, | 170 mm | AP 322/03 |
| Fig. 4, | 180 mm | AP 322/04 |

AA
AB
AC
AD
AE
AF
AK
AL
AM
AO
AP
AR
KA
KD
KU
KY

Kaltlicht Laryngoskope
 Fibre Optic Laryngoscopes
 Laringoscopios con luz fría
 Laryngoscopes à lumière froide
 Laringoscopi a luce fredda

FIBRE OPTIC



AP 340/00
 Ø 30 mm



AP 341/00
 Ø 20 mm



AP 345/01
 2,5 V
 Halogen



AP 345/02
 2,5 V
 Krypton

AP 345/03
 2,5 V
 Kaltlicht

Katheterzangen
Catheter Forceps
Pinzas para catéteres
Pincas pour sondes
Pinze per cannule

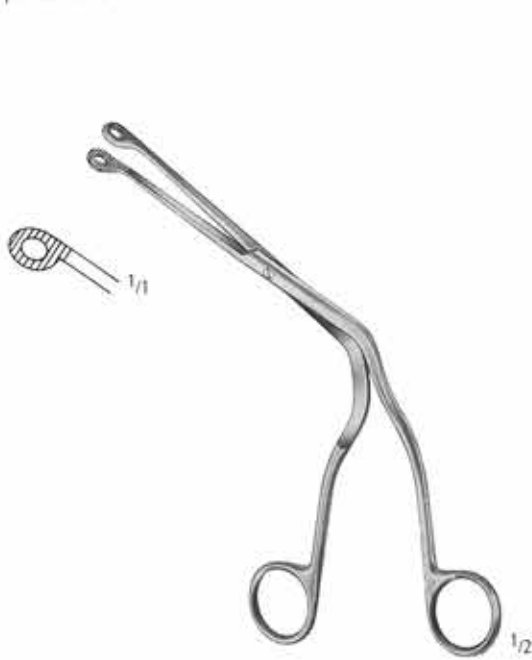

MAGILL
AP 410/16
16,0 cm/6¹/₄"



MAGILL
AP 410/20
20,0 cm/8"



MAGILL
AP 410/25
25,0 cm/10"

AA
AB
AC
AD
AE
AF
AK
AL
AM
AO
AP
AR
KA
KD
KU
KY

Anschluss Richard Wolf, Adapter oder andere Anschlüsse auf Wunsch
Richard Wolf connector, adaptor or other connectors on request
Conector Richard Wolf, adaptador o otros conectores diferentes sobre pedido
Connection Richard Wolf, adaptateur ou d'autres embouts à la demande
Connettore Richard Wolf, adattatori ed altri connettori su richiesta



157 mm = AP 425/01



182 mm = AP 427/01

NARKOSE ANAESTHESIA ANESTESIA ANESTHESIE ANESTESIA

Kaltlicht Laryngoskope
Fibre Optic Laryngoscopes
Laringoscopios con luz fría
Laryngoscopes à lumière froide
Laringoscopi a luce fredda

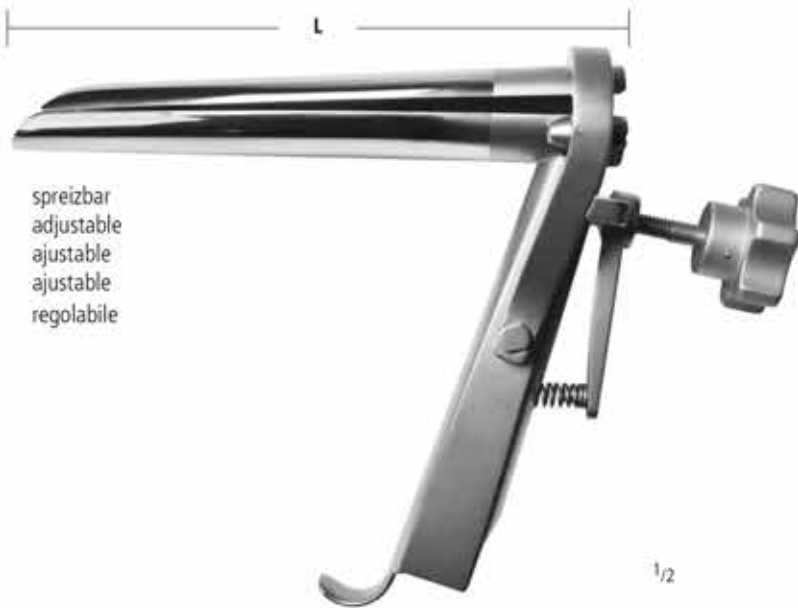

spreizbar
adjustable
ajustable
ajustable
regolabile

1/2

		[mm]			
		L	A	B	Ø
Fig. 1	AP 430/01	135	20	12	11
Fig. 2	AP 430/02	152	21	13	11
Fig. 3	AP 430/03	182	21	13	12
Fig. 4	AP 430/04	172	27	15	14,5
Fig. 5	AP 430/05	172	29	19	16
Fig. 6	AP 430/06	182	26	17	13x18
Fig. 7	AP 430/07	222	26	17	13x18

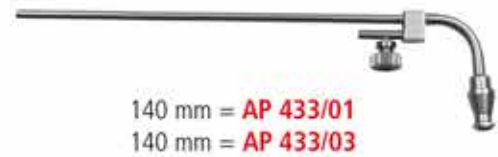

matte Oberfläche, für die Benutzung mit CO2-Laser
mat surface, for use with CO2 laser
superficie mate, para aplicación con láser de CO2
surface mate, pour l'application avec laser CO2
superficie opaca, per applicazione con laser CO2

1/2

		[mm]			
		L	A	B	Ø
Fig. 1	AP 440/01	135	20	12	11
Fig. 2	AP 440/02	152	21	13	11
Fig. 3	AP 440/03	182	21	13	12
Fig. 4	AP 440/04	172	27	15	14,5
Fig. 5	AP 440/05	172	29	19	16
Fig. 6	AP 440/06	182	26	17	13x18
Fig. 7	AP 440/07	222	26	17	13x18



AA
AB
AC
AD
AE
AF
AK
AL
AM
AO
AP
AR
KA
KD
KU
KY

Laryngoskope
Laryngoscopes
Laringoscopios
Laryngoscopes
Laringoscopi

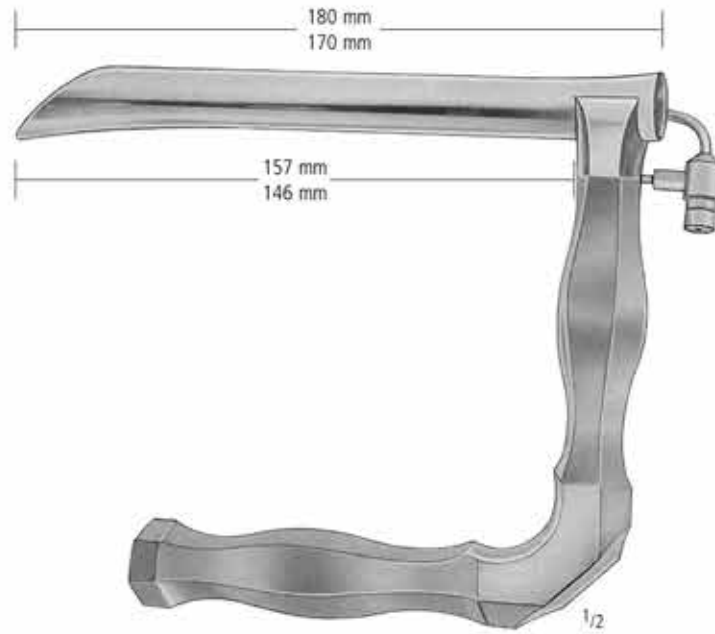

HOLINGER

157 mm = **AP 455/01**

146 mm = **AP 455/02**

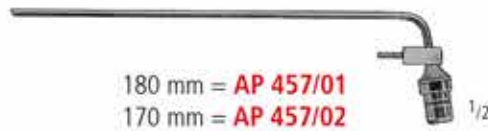

180 mm = **AP 457/01**

170 mm = **AP 457/02**

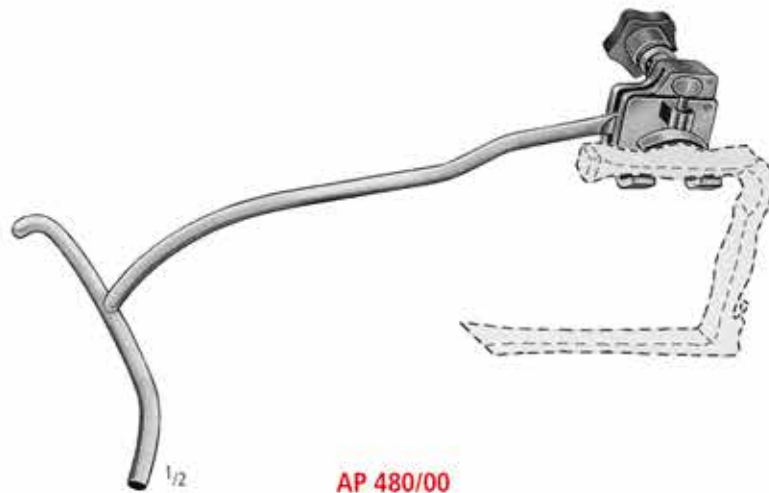

AP 480/00

Laryngoskope
Laryngoscopes
Laringoscopios
Laryngoscopes
Laringoscopi

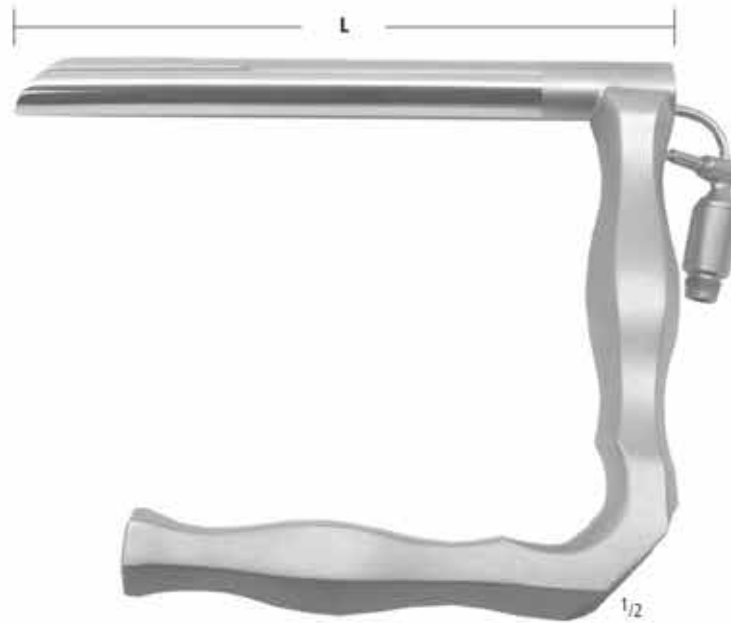

JACKSON

- L = 120 mm = **AP 465/12**
- L = 160 mm = **AP 465/16**
- L = 180 mm = **AP 465/18**



- 120 mm = **AP 470/12**
- 160 mm = **AP 470/16**
- 180 mm = **AP 470/18**

AA
AB
AC
AD
AE
AF
AK
AL
AM
AO
AP
AR
KA
KD
KU
KY



240 mm = **AP 481/24** for children
340 mm = **AP 481/34** for adults

DIAGNOSTIK
DIAGNOSTICS
DIAGNOSTICO
DIAGNOSTIC
DIAGNOSTICA

AR

nopa[®] instruments



Stirnspiegel
 Head Mirrors
 Espejos frontales
 Miroirs frontaux
 Specchi frontali

AA
 AB
 AC
 AD
 AE
 AF
 AK
 AL
 AM
 AO
 AP
 AR
 KA
 KD
 KU
 KY



LED 4 x AAA
 AR 090/00



90 mm = AR 102/09
 100 mm = AR 102/10



Stirnlampen
 Head Lamps
 Lámparas frontales
 Eclaireurs frontaux
 Lampade frontali



CLAR 55
AR 150/55
 6 V



CLAR STANDARD
AR 160/00
 6 V

Nystagmusbrillen
 Nystagmus Spectacles
 Gafas Nistagmo
 Lunettes Nystagmus
 Occhiali Nistagmo

AA
 AB
 AC
 AD
 AE
 AF
 AG
 AH
 AI
 AJ
 AK
 AL
 AM
 AN
 AO
 AP
 AR
 AS
 AT
 AU
 AV
 AW
 AX
 AY
 AZ



FRENZEL
AR 180/00



AR 180/22



AR 180/23



Perkussionshämmer
 Percussion Hammers
 Martillos de percusión
 Marteaux-percuteurs
 Martelli percussori



Perkussionshämmer
Percussion Hammers
Martillos de percusión
Marteaux-percuteurs
Martelli percussori



TROEMNER
AR 216/24
24,0 cm/9 1/2"



DÉJERINE
AR 217/20
20,0 cm/8"



DÉJERINE
AR 218/20
20,0 cm/8"

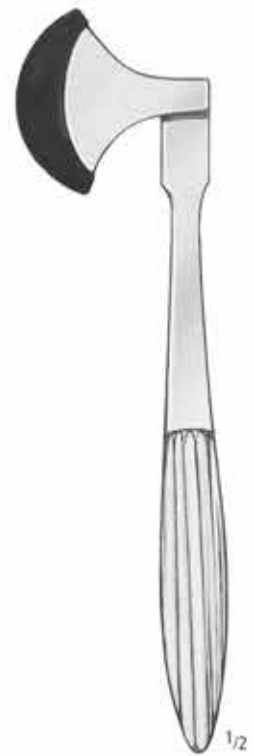

BERLINER
AR 220/20
20,0 cm/8"

AA
AB
AC
AD
AE
AF
AK
AL
AM
AO
AP
AR
KA
KD
KU
KY

Messinstrumente
 Measuring instruments
 Instrumentos para medidas
 Instruments pour mesurer
 Strumenti per misurare



- 15,0 cm/6" **AR 250/15**
- 20,0 cm/8" **AR 250/20**
- 30,0 cm/12" **AR 250/30**
- 50,0 cm/20" **AR 250/50**



AR 251/01
0-80 mm



AR 251/02
0-60 mm

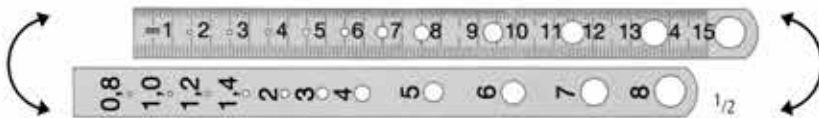

AR 255/15
150 mm

Messbereich und Lochlehre
 measuring range and hole gauge
 alcance de medición y calibre de agujeros
 pour mesurer et calibre avec trous
 per misurare fino e calibre forato



AR 256/15



- AR 258/50** röntgenfähig
- 50,0 cm/20" x-ray
- rayos x
- rayons x
- raggi x

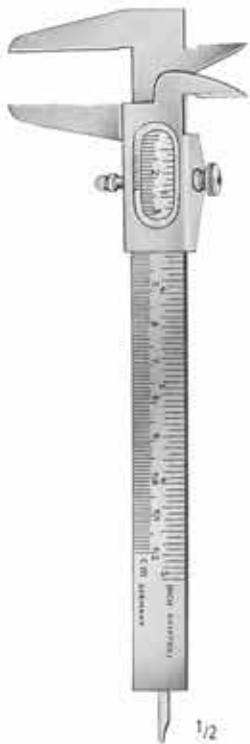

VERNIER
AR 260/12
0 - 120 mm

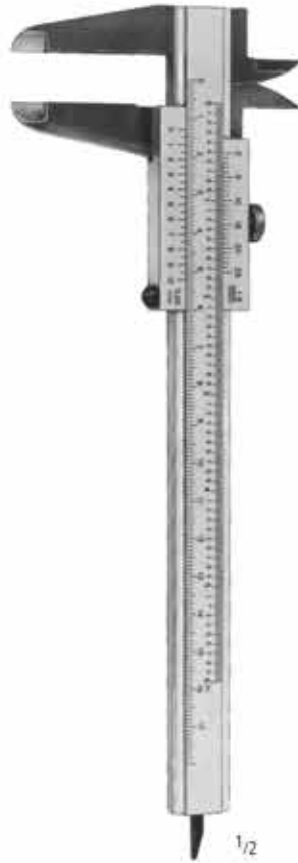

AR 260/18
0 - 200 mm / 0 - 8 inch



JAMESON
AR 261/08
0-80 mm / 0-3 inch



THORPE
AR 261/58
0 - 80 mm
0 - 3 inch



TOWNLEY
AR 262/12
0-80 mm



AR 263/11
0-100 mm



AR 263/12
0-80 mm



AR 263/13
0-80 mm

AA
AB
AC
AD
AE
AF
AK
AL
AM
AO
AP
AR
KA
KD
KU
KY



BOLEY
AR 264/11
 0-100 mm

BOLEY
AR 264/12
 0-100 mm

VERNIER
AR 265/20
 0-200 mm

MOELTGEN
AR 268/00

CAROLL
AR 270/00

DIAGNOSTIK DIAGNOSTICS DIAGNOSTICO DIAGNOSTIC DIAGNOSTICA

Messinstrumente
Measuring Instruments
Instrumentos para medidas
Instruments pour mesurer
Strumenti per misurare



COLLIN
AR 274/00
Erwachsene
Adults
Adultos
Adultes
Adulti

AR 275/00
Kinder
Children
Niños
Enfants
Bambini



IWANSON
AR 281/00
12,0 cm/4³/₄"
für Kronen
for crowns



IWANSON
AR 282/00
12,0 cm/4³/₄"
mit Tropfenspitzen für Wachs
with drop tips for wax



CASTROVIEJO
AR 282/15
8,0 cm/ 3"

Messbereich 15 mm
measuring range 15 mm
campo de medición 15 mm
étendue de mesurage 15 mm
ampiezza di misura 15 mm



CASTROVIEJO
AR 282/20
8,0 cm/ 3"

Messbereich 20 mm
measuring range 20 mm
campo de medición 20 mm
étendue de mesurage 20 mm
ampiezza di misura 20 mm



CASTROVIEJO
AR 283/20
8,0 cm/ 3"

Messbereich 20 mm
measuring range 20 mm
campo de medición 20 mm
étendue de mesurage 20 mm
ampiezza di misura 20 mm



CASTROVIEJO-EPKER
AR 284/09
9,0 cm/ 3¹/₂"
0-40 mm



CASTROVIEJO-EPKER
AR 284/18
18,0 cm/ 7"
0-40 mm

AA
AB
AC
AD
AE
AF
AG
AH
AI
AJ
AK
AL
AM
AN
AO
AP
AR
AS
AT
AU
AV
AW
AX
AY
AZ

Sensibilitäts-Instrumente
 Sensibility Instruments
 Instrumentos sensibilidad
 Instruments sensibilités
 Strumenti per sensibilità



AR 297/16
 16,0 cm/6 1/4"

AR 298/16
 16,0 cm/6 1/4"



ALY
AR 300/00
 19,0 cm/7 1/2"



WARTENBERG
AR 301/00



AR 302/00

Stethoskope
Stethoscopes
Estetoscopios
Stéthoscopes
Stetoscopi



aus Holz
of wood
de madera
en bois
in legno

1/2

PINARD
AR 310/01



aus Aluminium
of aluminium
de aluminio
en aluminium
in alluminio

1/2

PINARD
AR 310/02



aus Plastik
of plastic
de plástica
en plastique
in plastica

1/2

PINARD
AR 310/03

AA
AB
AC
AD
AE
AF
AG
AH
AI
AJ
AK
AL
AM
AN
AO
AP
AR
AS
AT
AU
AV
AW
AX
AY
AZ

Stethoskope
Stethoscopes
Estetoscopios
Stéthoscopes
Stetoscopi



CADIOPHON
AR 321/00



DUPLEX-LIGHTWEIGHT/BABY
AR 322/00 100 g

Blutdruckmesser
Blood Pressure Manometers
Manómetro para la presión de la sangre
Tensiomètre à mercure
Sfigmomanometro a mercurio



PRECISA
AR 352/00

AA

AB

AC

AD

AE

AF

AK

AL

AM

AO

AP

AR

KA

KD

KU

KY

Diagnostik-Bestecke
 Diagnostic Sets
 Juegos para diagnóstico
 Trousses à diagnostic
 Astucci per diagnostica



ECONOM
AR 400/00



RISCOPE S OTO - / OPHTHALMOSKOP
AR 402/00

Diagnostik-Bestecke
 Diagnostic Sets
 Juegos para diagnóstico
 Trousses à diagnostic
 Astucci per diagnostica



OTOSKOP UNI
AR 410/00



RISCOPE S OPTHALMOSKOP
AR 420/00

AA
 AB
 AC
 AD
 AE
 AF
 AG
 AH
 AI
 AJ
 AK
 AL
 AM
 AN
 AO
 AP
 AR
 AS
 AT
 AU
 AV
 AW
 AX
 AY

ORTHOPÄDIE
ORTHOPAEDIC
ORTOPEDIA
ORTHOPEDIE
ORTOPEDIA

KA

nopa[®] instruments



Amputations- und Resektionssägen
 Amputating and Resection Saws
 Sierras para amputación y resección
 Scies à amputation et résection
 Seghe per amputazione e resezione

Ersatzsägeblatt
 Spare saw blade
 Hoja de sierra de repuesto
 Lame de scie de rechange
 Lama di sega di ricambio

12 mm **KA 011/12**
 15 mm **KA 011/15**



CHARRIERE
KA 010/35
 35,0 cm/14"

Ersatzsägeblatt
 Spare saw blade
 Hoja de sierra de repuesto
 Lame de scie de rechange
 Lama di sega di ricambio

3 mm **KA 013/03**
 5 mm **KA 013/05**
 7 mm **KA 013/07**



HELFERICH-BIER
KA 012/39
 39,0 cm/15 1/2"



LINDEMANN
KA 017/20
 20,0 cm/8"



LANGENBECK
KA 018/23
 23,0 cm/9"



CHARRIERE
 27,0 cm/10 1/2" **KA 020/27**
 30,0 cm/12" **KA 020/30**
 34,0 cm/13 1/2" **KA 020/34**



SATTERLEE
KA 025/31
 31,0 cm/12 1/4"

Handbohrapparate
Hand Drills
Perforadores de mano
Perforateurs à main
Perforatori a mano

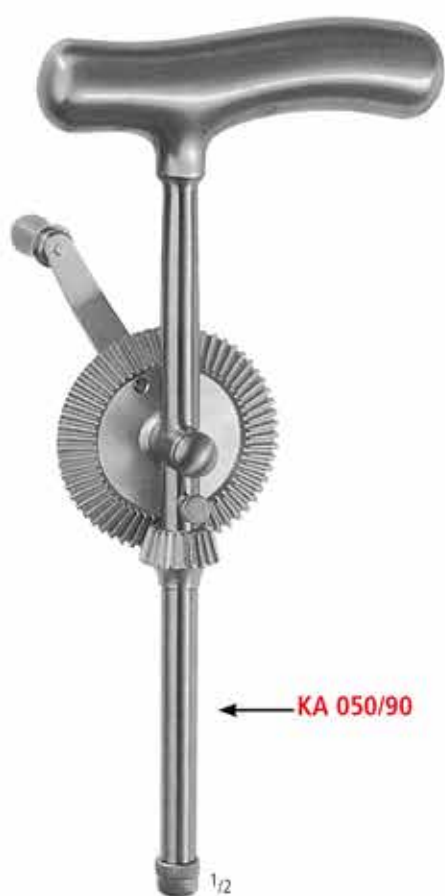

STILLE-SHERMAN

KA 050/24

24,0 cm/9¹/₂"

komplett
complete
completo
complet
completo



KA 051/25
Ø 2,5 mm



KA 051/30
Ø 3,0 mm



KA 051/35
Ø 3,5 mm

AA
AB
AC
AD
AE
AF
AK
AL
AM
AO
AP
AR
KA
KD
KU
KY

KA

Handbohrapparate
Hand Drills
Perforadores de mano
Perforateurs à main
Perforatori a mano



STILLE
KA 060/00
20,0 cm/8"

komplett mit
complete with
completo con
complet avec
completo con

Fig. 1-9
Fig. 1-9
Fig. 1-9
Fig. 1-9
Fig. 1-9



Fig. 1
KA 060/01
Ø 2,5 mm



Fig. 2
KA 060/02
Ø 3,0 mm



Fig. 3
KA 060/03
Ø 3,5 mm



Fig. 4
KA 060/04
Ø 4,0 mm



Fig. 5
KA 060/05
Ø 10,0 mm



Fig. 6
KA 060/06
Ø 5,0 mm



Fig. 7
KA 060/07
Ø 8,0 mm



Fig. 8
KA 060/08
Ø 12,0 mm

← KA 060/90



Fig. 9
KA 060/09
Ø 16,0 mm



Fig. 10
KA 060/10
Ø 1,0 mm



Fig. 11
KA 060/11
Ø 1,5 mm



Fig. 12
KA 060/12
Ø 2,0 mm

Handbohrapparate
Hand Drills
Perforadores de mano
Perforateurs à main
Perforatori a mano



HUDSON
KA 070/00
27,0 cm/10¹/₂"

komplett mit
complete with
completo con
complet avec
completo con

KA 070/01-04, 09
KA 070/01-04, 09
KA 070/01-04, 09
KA 070/01-04, 09
KA 070/01-04, 09



1/2



1/2



1/2



1/2



1/2



1/2

KA 070/01
Ø 9,0 mm

KA 070/02
Ø 14,0 mm

KA 070/03
Ø 16,0 mm

KA 070/04
Ø 22,0 mm

CUSHING
KA 070/05
Ø 14,0 mm

KA 070/09



1/2

Ø 3,2 mm
9,0 cm



1/2

Ø 3,2 mm
7,0 cm

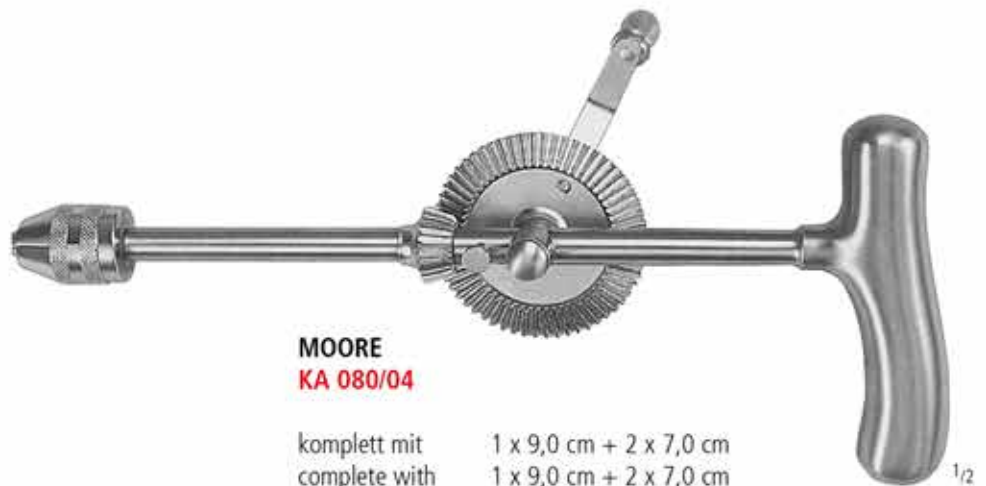

MOORE
KA 080/04

komplett mit
complete with
completo con
complet avec
completo con

1 x 9,0 cm + 2 x 7,0 cm
1 x 9,0 cm + 2 x 7,0 cm
1 x 9,0 cm + 2 x 7,0 cm
1 x 9,0 cm + 2 x 7,0 cm
1 x 9,0 cm + 2 x 7,0 cm

1/2

AA
AB
AC
AD
AE
AF
AK
AL
AM
AO
AP
AR
KA
KD
KU
KY

Handbohrapparate
 Hand Drills
 Perforadores de mano
 Perforateurs à main
 Perforatori a mano



KA 094/00

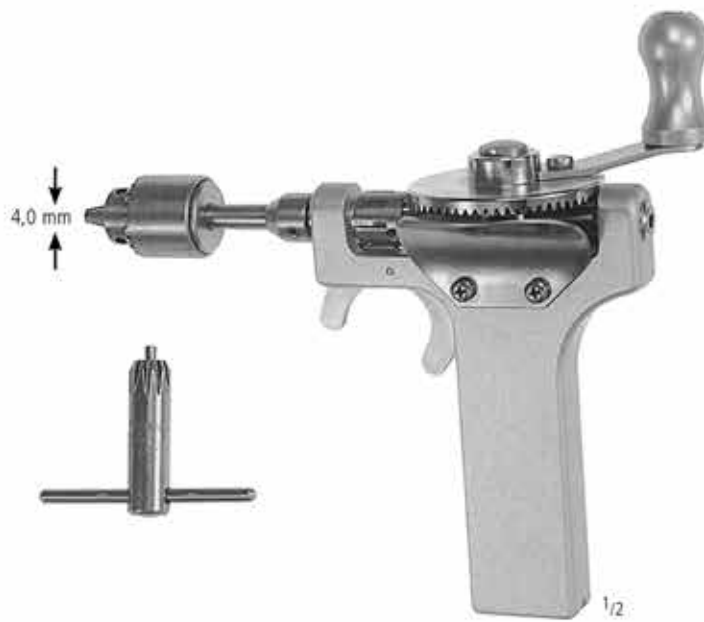

BUNNELL
KA 096/00

Handbohrapparate
Hand Drills
Perforadores de mano
Perforateurs à main
Perforatori a mano



UNIVERSAL 11"
KA 098/00



RALK
KA 100/00



Ø 1,0 mm	KA 102/10
Ø 1,5 mm	KA 102/15
Ø 2,0 mm	KA 102/20
Ø 2,7 mm	KA 102/27
Ø 3,0 mm	KA 102/30
Ø 3,2 mm	KA 102/32
Ø 3,5 mm	KA 102/35
Ø 4,0 mm	KA 102/40
Ø 4,5 mm	KA 102/45
Ø 5,0 mm	KA 102/50
Ø 6,0 mm	KA 102/60
Ø 7,0 mm	KA 102/70
Ø 8,0 mm	KA 102/80
Ø 9,0 mm	KA 102/90
Ø 10,0 mm	KA 102/99

AA
AB
AC
AD
AE
AF
AK
AL
AM
AO
AP
AR
KA
KD
KU
KY

Handbohrapparate
Hand Drills
Perforadores de mano
Perforateurs à main
Perforatori a mano



KA 103/00



KA 103/10



KA 104/00
16,0 cm/6¹/₄"



PERTHES
KA 104/01
21,0 cm/8¹/₄"



KA 104/02
14,0 cm/5¹/₂"

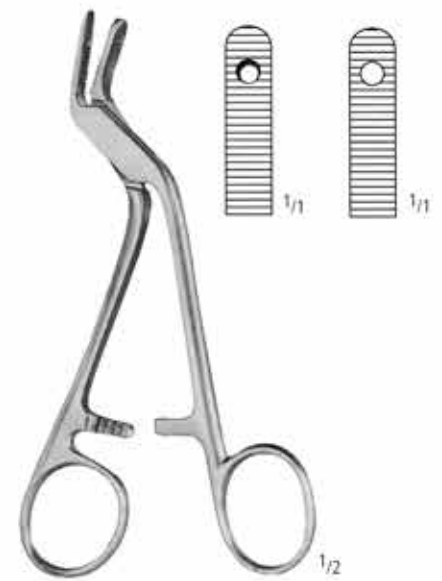

ADISON
KA 104/03
15,0 cm/6"



KA 120/00

Akku Bohrapparat / Accu power drill

Spannung / Voltage	9,6 Volt
Drehzahl / Revolutions	0-750 U/min
Leistung / Power	130/200 Watt



KA 121/00

Luft Bohrapparat / Air power drill

Drehzahl / Revolutions	600 U/min
Druck / Compression	6,5 bar

AA
AB
AC
AD
AE
AF
AK
AL
AM
AO
AP
AR
KA
KD
KU
KY

Zubehör für KA 120/00 und KA 121/00
 Accessories for KA 120/00 and KA 121/00
 Accesorios para KA 120/00 y KA 121/00
 Accessoires pour KA 120/00 et KA 121/00
 Accessori per KA 120/00 e KA 121/00



KA 122/10
 Adapter mit Jacobs Spannfutter
 Adapter with Jacobs chuck



KA 122/16
 Schnellspannfutter für Kirschnerdrähte 0,8 bis 3mm
 Quick-action chuck for Kirschner wires 0,8 to 3mm



KA 122/11
 Adapter für AO Schaft
 Adapter for AO shank



KA 123/01
 Osteotomie Säge oszillierend
 Sagittal saw oscillating



KA 122/13
 Adapter für DIN Schaft
 Adapter for DIN shank



KA 123/02
 Sternum Säge
 Sternum Saw



KA 122/14
 Adapter für Harris Schaft
 Adapter for Harris shank



KA 122/15
 Adapter für Hudson Schaft
 Adapter for Hudson shank

Ladegerät / Akku
 Charger / Battery
 Cargador / acumulador
 Chargeur d'accus / accumulateur
 Caricabatteria / accumulatore



KA 124/01

Ladegerät Netzspannung 115V / 240V Ladezeit 60 min
 Charger main voltage 115V / 240V charging time 60 min



KA 124/02

Ladegerät für 2 Akkus Netzspannung 115V / 240V Ladezeit 60 min
 Charger for 2 batteries main voltage 115V / 240V Charging time 60 min



KA 124/10
 9,6V 2600mAh



KA 124/11
 12V 2600mAh

AA
 AB
 AC
 AD
 AE
 AF
 AK
 AL
 AM
 AO
 AP
 AR
KA
 KD
 KU
 KY

Knochenhalteklammern
 Bone Holding Clamps
 Clamp sujetador de huesos
 Daviers à os
 Tenaglie per ossa



GERSTER-LOWMANN

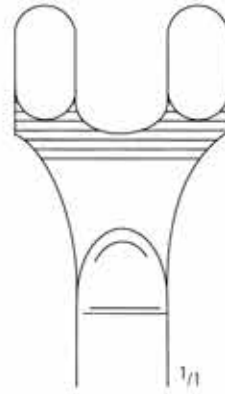

KA 155/18
 18,0 cm/7"

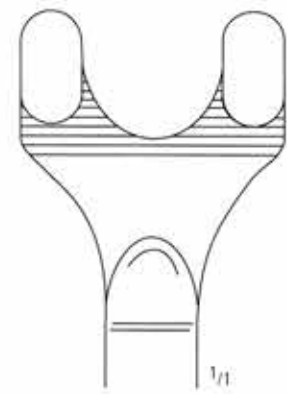

KA 155/20
 20,0 cm/8"

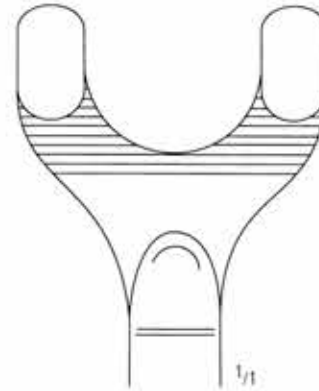

KA 155/22
 22,0 cm/8³/₄"



GERSTER
KA 155/90

Knochenhebel
 Bone Levers
 Elevadores para huesos
 Leviers à os
 Elevatori per ossa

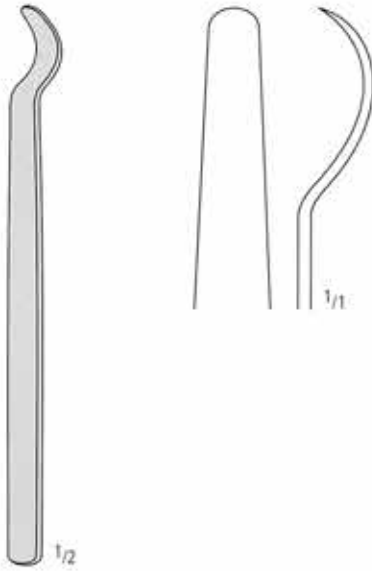

KA 170/00
 14,0 cm/5¹/₂"

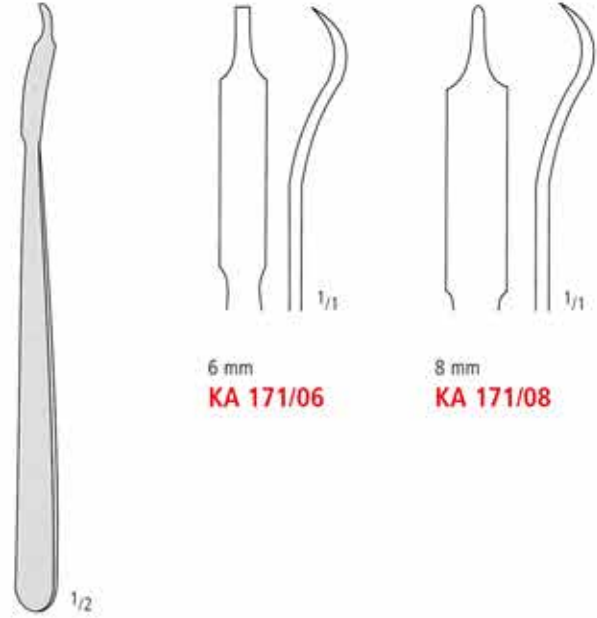

6 mm
KA 171/06

8 mm
KA 171/08

MINI-HOHMANN
 16,0 cm/6¹/₄"

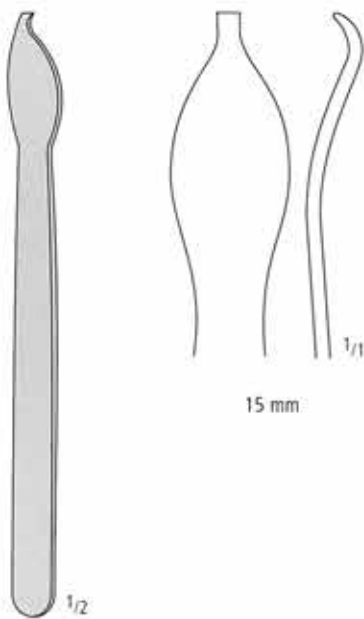

KA 171/15
 17,0 cm/6³/₄"

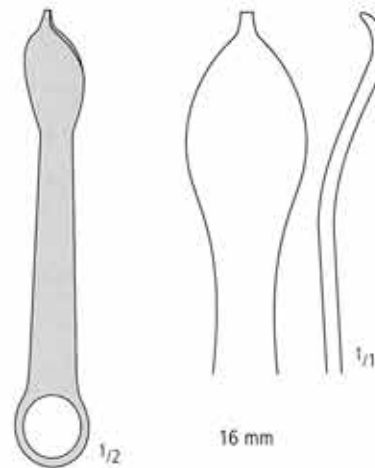

KA 171/16
 12,0 cm/4³/₄"

AA
 AB
 AC
 AD
 AE
 AF
 AG
 AH
 AI
 AJ
 AK
 AL
 AM
 AN
 AO
 AP
 AQ
 AR
 AS
KA
 KD
 KE
 KF

Knochenhebel
 Bone Levers
 Elevadores para huesos
 Leviers à os
 Elevatori per ossa

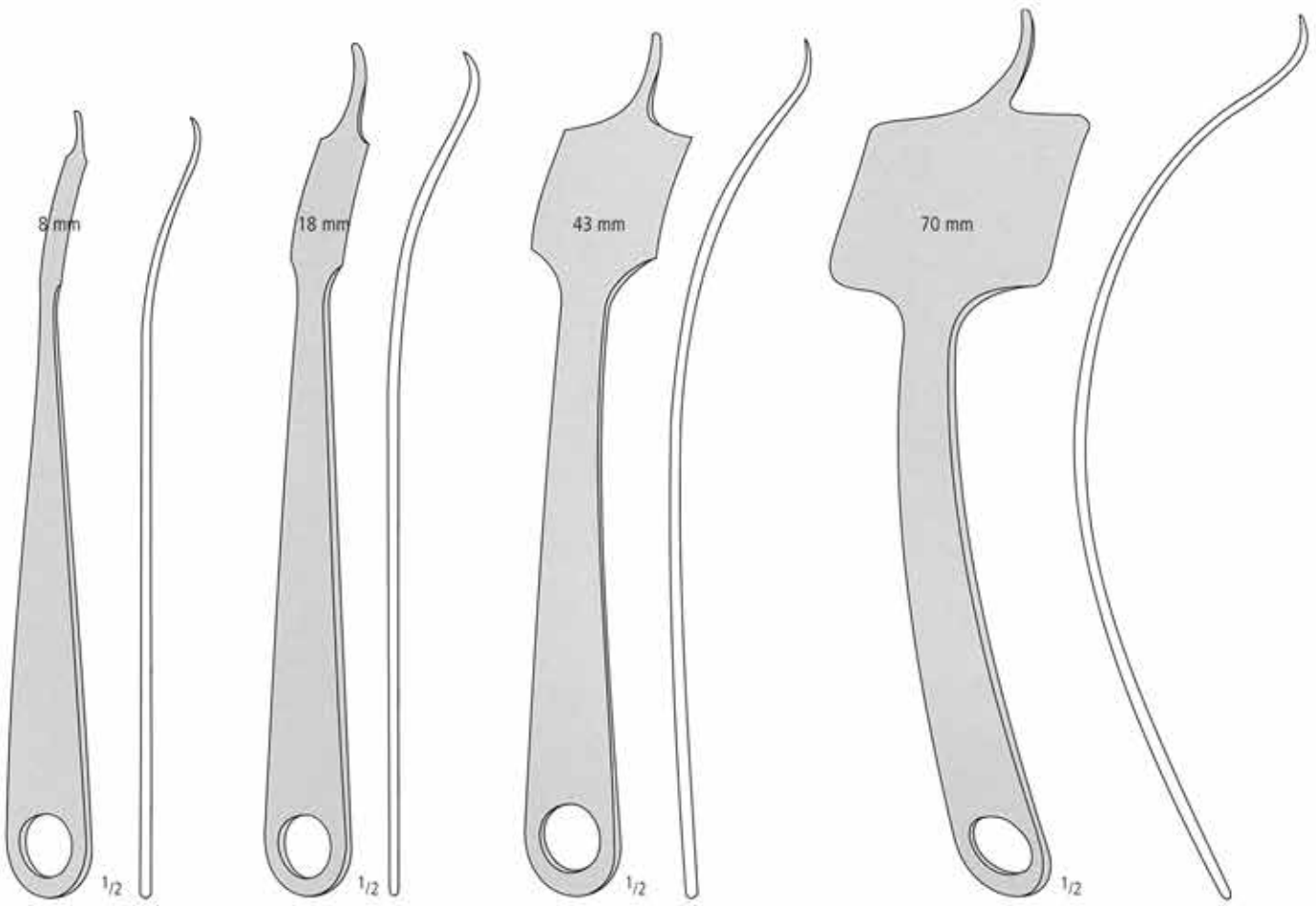

HOHMANN
KA 172/08
 22,0 cm/8³/₄"

HOHMANN
KA 172/18
 24,0 cm/9¹/₂"

HOHMANN
KA 172/43
 26,0 cm/10¹/₄"

HOHMANN
KA 172/70
 29,0 cm/11¹/₂"

Knochenhebel
 Bone Levers
 Elevadores para huesos
 Leviers à os
 Elevatori per ossa

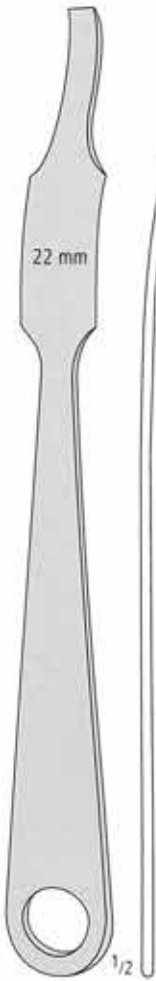

HOHMANN
KA 173/22
 25,0 cm/9³/₄"

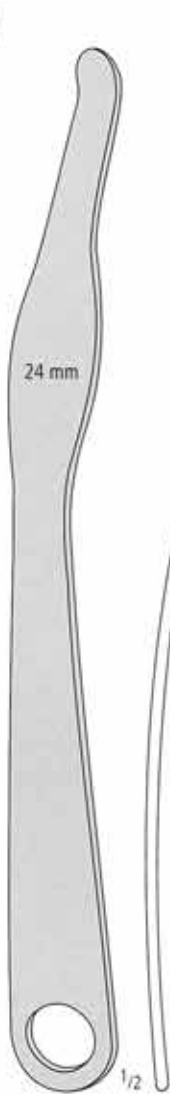

HOHMANN
KA 173/24
 28,0 cm/11"

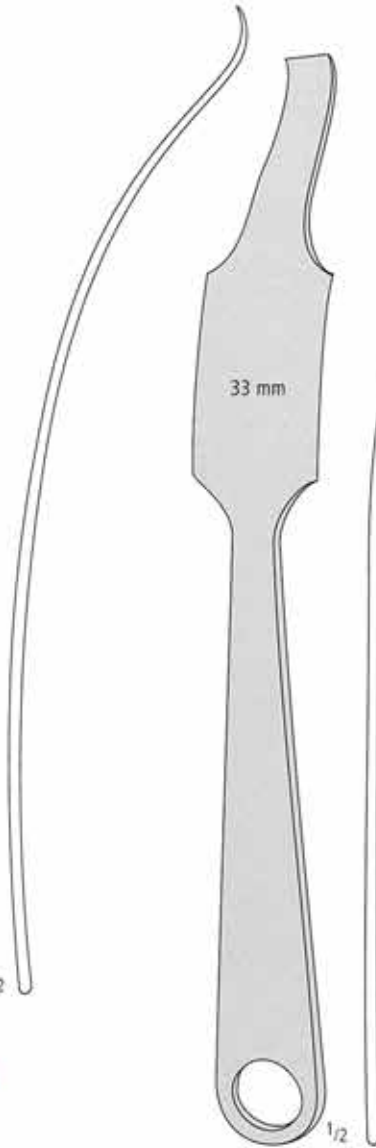

HOHMANN
KA 173/35
 29,0 cm/11¹/₂"



HOHMANN
KA 173/43
 25,0 cm/9³/₄"

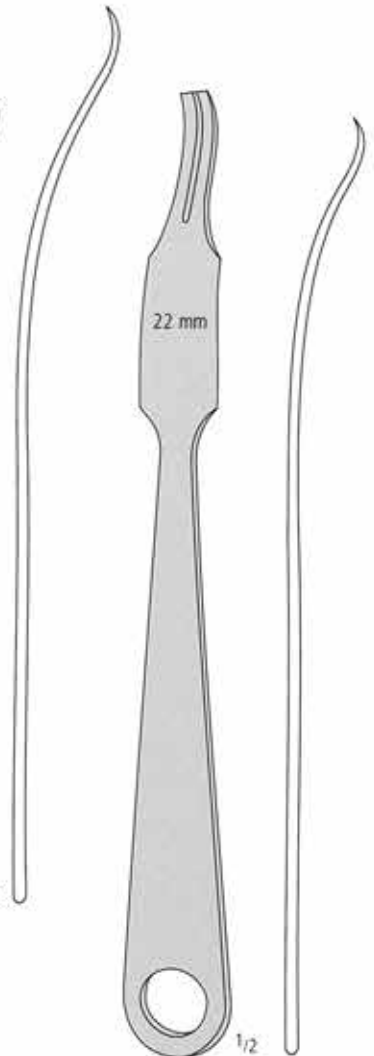

LANGE-HOHMANN
KA 174/22
 26,0 cm/10¹/₄"

AA
 AB
 AC
 AD
 AE
 AF
 AG
 AH
 AI
 AJ
 AK
 AL
 AM
 AN
 AO
 AP
 AQ
 AR
 AS
 AT
 AU
 AV
 AW
 AX
 AY
 AZ

KA

KD
 KE
 KF
 KG
 KH
 KI
 KJ
 KK
 KL
 KM
 KN
 KO
 KP
 KQ
 KR
 KS
 KT
 KU
 KV
 KW
 KY
 KZ

Knochenhebel
Bone Levers
Elevadores para huesos
Leviers à os
Elevatori per ossa



BLOUNT
KA 175/26
26,0 cm/10¹/₄"



BLOUNT
KA 176/26
26,0 cm/10¹/₄"



TAYLOR
16,5 cm/6¹/₂"

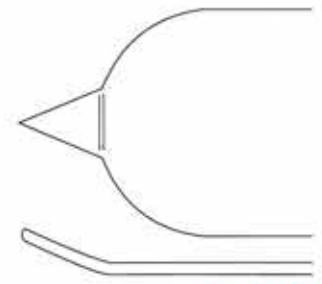

KA 177/01
75 x 30 mm

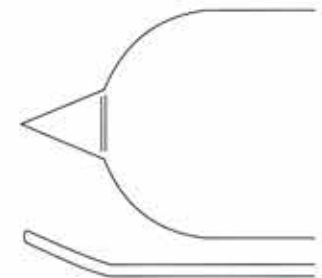

KA 177/02
100 x 30 mm

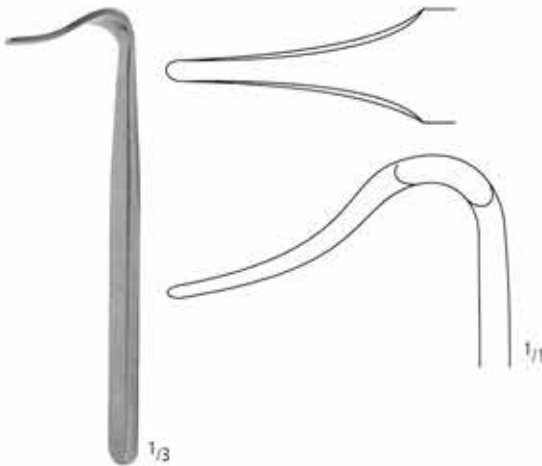

BLOUNT
KA 177/17
17,5 cm/7"



CREGO
KA 178/01
19,0 cm/7¹/₂"



CREGO
KA 178/02
19,0 cm/7¹/₂"



CREGO
KA 178/03
19,0 cm/7¹/₂"



CREGO
KA 178/04
19,0 cm/7¹/₂"

Extensionsbügel
 Extension Bows
 Estribos para extensión
 Etriers à extension
 Archi per estensione

AA
AB
AC
AD
AE
AF
AK
AL
AM
AO
AP
AR
KA
KD
KU
KY

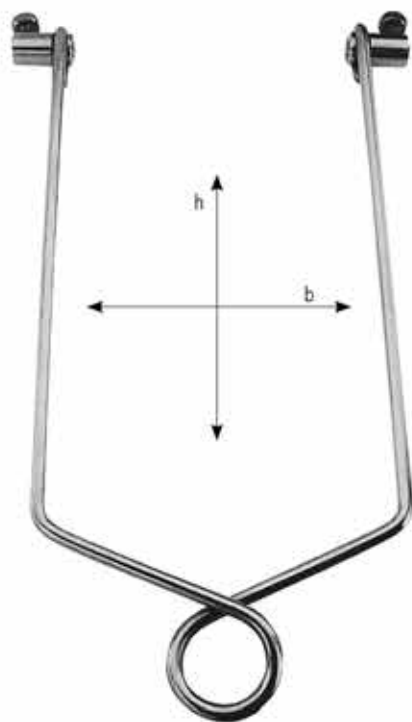

BÖHLER

cm h x b	in. h x b	
16 x 9	6 ¹ / ₄ x 3 ¹ / ₂	KA 200/01
21 x 11	8 ¹ / ₄ x 4 ¹ / ₃	KA 200/02
21 x 15	8 ¹ / ₄ x 6	KA 200/03

für Arm
 for arm
 para brazo
 pour bras
 per braccio

für Oberschenkel und Knie
 for thigh and knee
 para muslo y rodilla
 pour fémur et genou
 per femore e ginocchio

für Oberschenkel und Knie
 for thigh and knee
 para muslo y rodilla
 pour fémur et genou
 per femore e ginocchio



STEINMANN

Ø	L	
4 mm	130 mm	KA 201/13
4 mm	140 mm	KA 201/14
4 mm	150 mm	KA 201/15
4 mm	160 mm	KA 201/16
4 mm	180 mm	KA 201/18
4 mm	200 mm	KA 201/20
4 mm	210 mm	KA 201/21

KA

Extensionsbügel
 Extension Bows
 Estribos para extensión
 Etriers à extension
 Archi per estensione

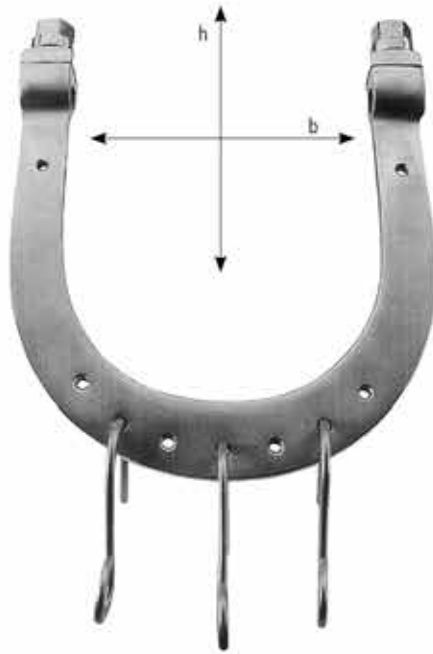

KIRSCHNER

cm
h x b

in.
h x b

6,0 x 6,0
 7,0 x 9,5
 10,5 x 10,5
 12,0 x 12,0
 15,5 x 15,5
 15,5 x 20,0

2¹/₂ x 2¹/₂
 2³/₄ x 3³/₄
 4¹/₄ x 4¹/₄
 4³/₄ x 4³/₄
 6 x 6
 6 x 8

KA 220/00
KA 220/01
KA 220/02
KA 220/03
KA 220/04
KA 220/05



KA 220/90

Drahtzangen
Wire Forceps
Pinzas para hilos
Pincers à fil
Tenaglie fili



NIRO
KA 250/00
15,0 cm/6"



KA 250/14
14,0 cm/5 1/2"



KA 251/14
14,0 cm/5 1/2"



KA 252/16
16,0 cm/6 1/4"



KA 253/19
19,0 cm/7 1/2"

AA
AB
AC
AD
AE
AF
AK
AL
AM
AO
AP
AR
KA
KD
KU
KY

Drahtzangen
Wire Forceps
Pinzas para hilos
Pincers à fil
Tenaglie fili



KA 255/01

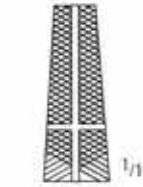

KA 255/02



KA 257/15
15,0 cm/6"

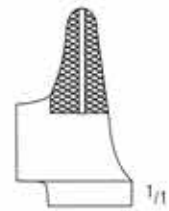

17,0 cm/6³/₄"



18,0 cm/7"

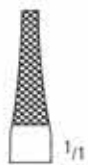

KA 260/18



KA 261/18



KA 262/18

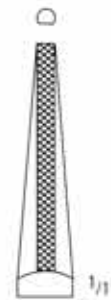

KA 263/18

ORTHOPÄDIE ORTHOPAEDIC ORTOPEDIA ORTHOPEDIE ORTOPEDIA

Drahtzangen
Wire Forceps
Pinzas para hilos
Pincas à fil
Tenaglie fili



STERNUM

nopa®
TUC

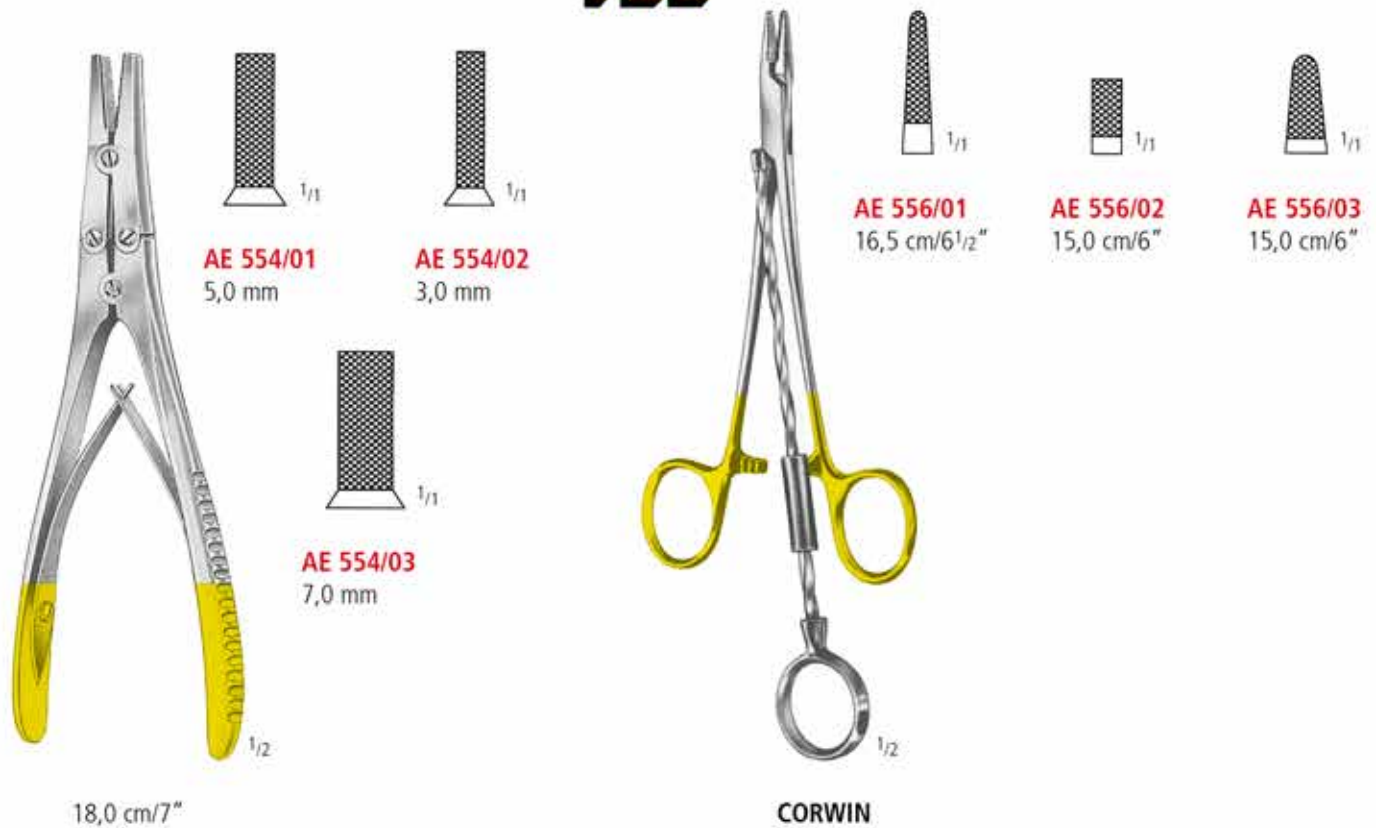

AA
AB
AC
AD
AE
AF
AG
AH
AI
AJ
AK
AL
AM
AN
AO
AP
AQ
AR
AS
AT
AU
AV
AW
AX
AY
AZ
BA
BB
BC
BD
BE
BF
BG
BH
BI
BJ
BK
BL
BM
BN
BO
BP
BQ
BR
BS
BT
BU
BV
BW
BX
BY
BZ
CA
CB
CC
CD
CE
CF
CG
CH
CI
CJ
CK
CL
CM
CN
CO
CP
CQ
CR
CS
CT
CU
CV
CW
CX
CY
CZ
DA
DB
DC
DD
DE
DF
DG
DH
DI
DJ
DK
DL
DM
DN
DO
DP
DQ
DR
DS
DT
DU
DV
DW
DX
DY
DZ
EA
EB
EC
ED
EE
EF
EG
EH
EI
EJ
EK
EL
EM
EN
EO
EP
EQ
ER
ES
ET
EU
EV
EW
EX
EY
EZ
FA
FB
FC
FD
FE
FF
FG
FH
FI
FJ
FK
FL
FM
FN
FO
FP
FQ
FR
FS
FT
FU
FV
FW
FX
FY
FZ
GA
GB
GC
GD
GE
GF
GG
GH
GI
GJ
GK
GL
GM
GN
GO
GP
GQ
GR
GS
GT
GU
GV
GW
GX
GY
GZ
HA
HB
HC
HD
HE
HF
HG
HH
HI
HJ
HK
HL
HM
HN
HO
HP
HQ
HR
HS
HT
HU
HV
HW
HX
HY
HZ
IA
IB
IC
ID
IE
IF
IG
IH
II
IJ
IK
IL
IM
IN
IO
IP
IQ
IR
IS
IT
IU
IV
IW
IX
IY
IZ
JA
JB
JC
JD
JE
JF
JG
JH
JI
JJ
JK
JL
JM
JN
JO
JP
JQ
JR
JS
JT
JU
JV
JW
JX
JY
JZ
KA
KB
KC
KD
KE
KF
KG
KH
KI
KJ
KK
KL
KM
KN
KO
KP
KQ
KR
KS
KT
KU
KV
KW
KX
KY
KZ
LA
LB
LC
LD
LE
LF
LG
LH
LI
LJ
LK
LL
LM
LN
LO
LP
LQ
LR
LS
LT
LU
LV
LW
LX
LY
LZ
MA
MB
MC
MD
ME
MF
MG
MH
MI
MJ
MK
ML
MM
MN
MO
MP
MQ
MR
MS
MT
MU
MV
MW
MX
MY
MZ
NA
NB
NC
ND
NE
NF
NG
NH
NI
NJ
NK
NL
NM
NN
NO
NP
NQ
NR
NS
NT
NU
NV
NW
NX
NY
NZ
OA
OB
OC
OD
OE
OF
OG
OH
OI
OJ
OK
OL
OM
ON
OO
OP
OQ
OR
OS
OT
OU
OV
OW
OX
OY
OZ
PA
PB
PC
PD
PE
PF
PG
PH
PI
PJ
PK
PL
PM
PN
PO
PP
PQ
PR
PS
PT
PU
PV
PW
PX
PY
PZ
QA
QB
QC
QD
QE
QF
QG
QH
QI
QJ
QK
QL
QM
QN
QO
QP
QQ
QR
QS
QT
QU
QV
QW
QX
QY
QZ
RA
RB
RC
RD
RE
RF
RG
RH
RI
RJ
RK
RL
RM
RN
RO
RP
RQ
RR
RS
RT
RU
RV
RW
RX
RY
RZ
SA
SB
SC
SD
SE
SF
SG
SH
SI
SJ
SK
SL
SM
SN
SO
SP
SQ
SR
SS
ST
SU
SV
SW
SX
SY
SZ
TA
TB
TC
TD
TE
TF
TG
TH
TI
TJ
TK
TL
TM
TN
TO
TP
TQ
TR
TS
TT
TU
TV
TW
TX
TY
TZ
UA
UB
UC
UD
UE
UF
UG
UH
UI
UJ
UK
UL
UM
UN
UO
UP
UQ
UR
US
UT
UU
UV
UW
UX
UY
UZ
VA
VB
VC
VD
VE
VF
VG
VH
VI
VJ
VK
VL
VM
VN
VO
VP
VQ
VR
VS
VT
VU
VV
VW
VX
VY
VZ
WA
WB
WC
WD
WE
WF
WG
WH
WI
WJ
WK
WL
WM
WN
WO
WP
WQ
WR
WS
WT
WU
WV
WW
WX
WY
WZ
XA
XB
XC
XD
XE
XF
XG
XH
XI
XJ
XK
XL
XM
XN
XO
XP
XQ
XR
XS
XT
XU
XV
XW
XX
XY
XZ
YA
YB
YC
YD
YE
YF
YG
YH
YI
YJ
YK
YL
YM
YN
YO
YP
YQ
YR
YS
YT
YU
YV
YW
YX
YY
YZ
ZA
ZB
ZC
ZD
ZE
ZF
ZG
ZH
ZI
ZJ
ZK
ZL
ZM
ZN
ZO
ZP
ZQ
ZR
ZS
ZT
ZU
ZV
ZW
ZX
ZY
ZZ

Flachzangen
 Flat Nose Pliers
 Alicates planos
 Pinces plates
 Tenaglie piatte

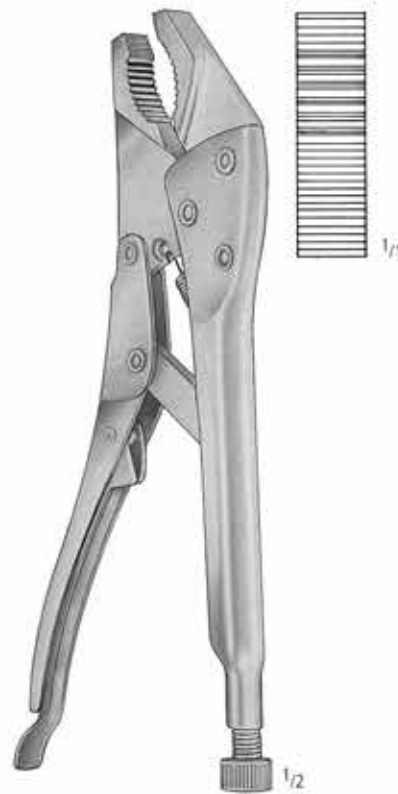

KA 265/18
 18,0 cm/7"

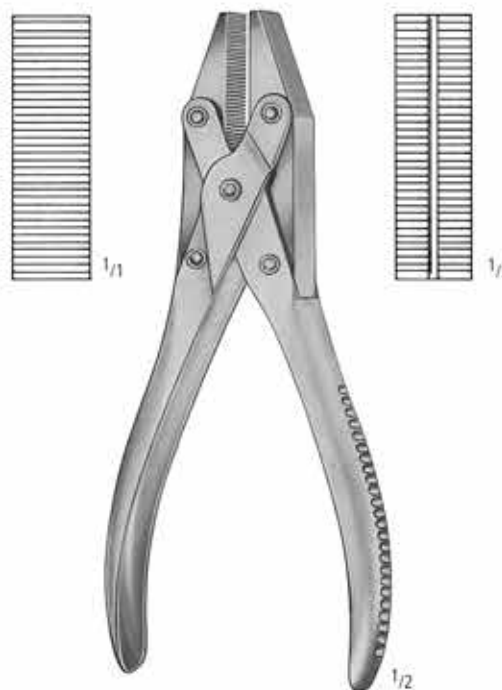

KA 266/17
 17,0 cm/6³/₄"

Drahtzangen
Wire Forceps
Pinzas para hilos
Pinces à fil
Tenaglie fili



für weiche Drähte bis 1,2 mm Ø
for soft wires up to 1,2 mm Ø
para hilos blandos hasta 1,2 mm de Ø
pour fils mous jusqu'à 1,2 mm de Ø
per fili morbidi sino a mm 1,2 di Ø

für harte Drähte bis 1,0 mm Ø
for hard wires up to 1,0 mm Ø
para hilos duros hasta 1,0 mm de Ø
pour fils durs jusqu'à 1,0 mm de Ø
per fili duri sino a mm 1,0 di Ø

1/2

KA 270/15
15,0 cm/6"



KA 271/16
16 cm/6 1/4"



für weiche Drähte bis 2,0 mm Ø
for soft wires up to 2,0 mm Ø
para hilos blandos hasta 2,0 mm de Ø
pour fils mous jusqu'à 2,0 mm de Ø
per fili morbidi sino a mm 2,0 di Ø

für harte Drähte bis 1,5 mm Ø
for hard wires up to 1,5 mm Ø
para hilos duros hasta 1,5 mm de Ø
pour fils durs jusqu'à 1,5 mm de Ø
per fili duri sino a mm 1,5 di Ø

1/2

KA 272/18
18,0 cm/7"

nopa[®]
TUC



für weiche Drähte bis 2,0 mm Ø
for soft wires up to 2,0 mm Ø
para hilos blandos hasta 2,0 mm de Ø
pour fils mous jusqu'à 2,0 mm de Ø
per fili morbidi sino a mm 2,0 di Ø

für harte Drähte bis 1,6 mm Ø
for hard wires up to 1,6 mm Ø
para hilos duros hasta 1,6 mm de Ø
pour fils durs jusqu'à 1,6 mm de Ø
per fili duri sino a mm 1,6 di Ø

1/2

KA 273/17
17,0 cm/6 3/4"

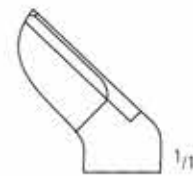

für Drähte bis 2,5 mm Ø
for wires up to 2,5 mm Ø
para hilos hasta 2,5 mm de Ø
pour fils jusqu'à 2,5 mm de Ø
per fili sino a mm 2,5 di Ø

1/2

KA 273/22
22 cm/8 3/4"

AA
AB
AC
AD
AE
AF
AK
AL
AM
AO
AP
AR
KA
KD
KU
KY

Drahtzangen
Wire Forceps
Pinzas para hilos
Pinces à fil
Tenaglie fili



KA 275/47
47,0 cm/18 1/2"

Drahtspanninstrumente
 Wire Twisting Instruments
 Tensores cierra-hilos
 Tendeurs s erre-fils
 Strumenti tendifili



LOUTE
KA 280/21
 21,0 cm/8¹/₄"



DEMEL

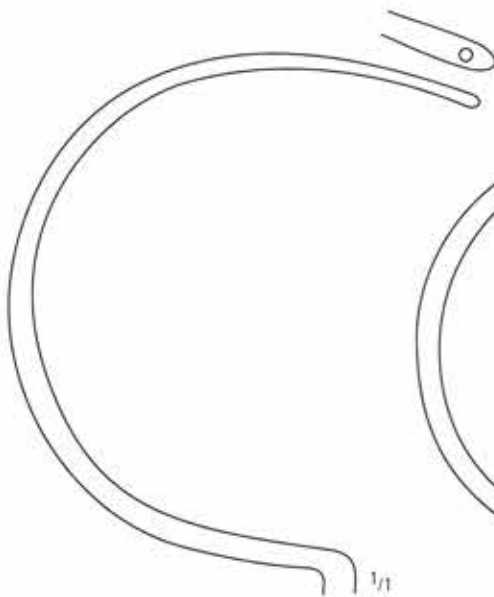

KA 281/01
 30,5 cm/12"

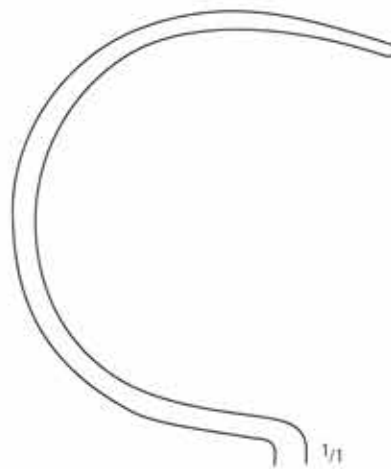

KA 281/02
 28,5 cm/11¹/₄"



KA 281/03
 27,5 cm/10³/₄"

AA
 AB
 AC
 AD
 AE
 AF
 AK
 AL
 AM
 AO
 AP
 AR
KA
 KD
 KU
 KY

Arthroskopie
Arthroscopy
Artroscopia
Arthroscopie
Artroscopia



Ø 4 mm
KA 300/01
22,5 cm/9"

5 mm



KA 300/02



KA 300/03



KA 300/04



KA 300/05

4 mm



KA 300/06

3 mm



KA 300/07

1/1

Ø 3 mm



KA 300/08



KA 300/09



KA 300/10

Ø 3 mm



KA 300/11



KA 300/12

3,5 mm



KA 300/13

1/1

ORTHOPÄDIE ORTHOPAEDIC ORTOPEDIA ORTHOPEDIE ORTOPEDIA

Arthroskopie
Arthroscopy
Artroscopia
Arthroscopie
Artroscopia

Griff allein
Handle only
Mango solo
Manche seul
Solo impugnatura



KA 302/00
12,5 cm/5"



KA 302/01 **KA 302/02** **KA 302/03** **KA 302/04** **KA 302/05** **KA 302/06**



KA 302/07 **KA 302/08** **KA 302/09** **KA 302/10** **KA 302/11** **KA 302/12**

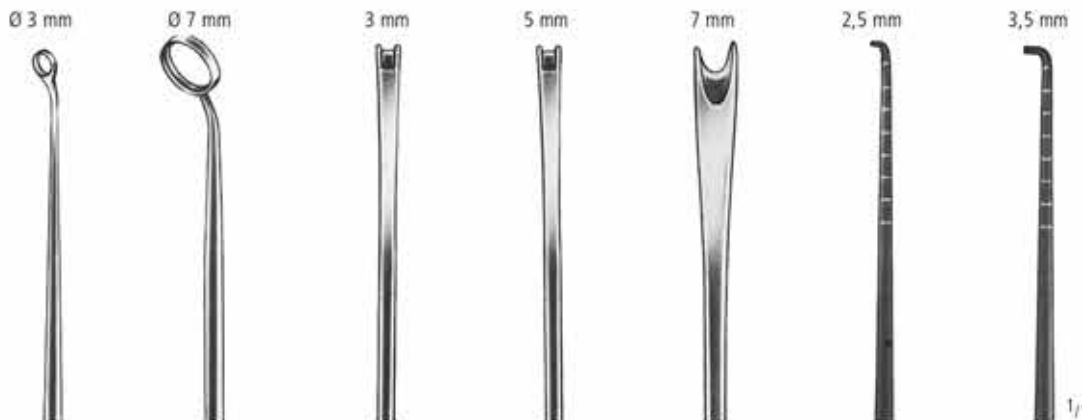

KA 302/13 **KA 302/14** **KA 302/15** **KA 302/16** **KA 302/17** **KA 302/18** **KA 302/19**

Ø 3 mm

Ø 3 mm

Ø 7 mm

3 mm

5 mm

7 mm

2,5 mm

3,5 mm

AA
AB
AC
AD
AE
AF
AG
AH
AI
AJ
AK
AL
AM
AN
AO
AP
AQ
AR
AS
AT
AU
AV
AW
AX
AY
AZ
BA
BB
BC
BD
BE
BF
BG
BH
BI
BJ
BK
BL
BM
BN
BO
BP
BQ
BR
BS
BT
BU
BV
BW
BX
BY
BZ
CA
CB
CC
CD
CE
CF
CG
CH
CI
CJ
CK
CL
CM
CN
CO
CP
CQ
CR
CS
CT
CU
CV
CW
CX
CY
CZ
DA
DB
DC
DD
DE
DF
DG
DH
DI
DJ
DK
DL
DM
DN
DO
DP
DQ
DR
DS
DT
DU
DV
DW
DX
DY
DZ
EA
EB
EC
ED
EE
EF
EG
EH
EI
EJ
EK
EL
EM
EN
EO
EP
EQ
ER
ES
ET
EU
EV
EW
EX
EY
EZ
FA
FB
FC
FD
FE
FF
FG
FH
FI
FJ
FK
FL
FM
FN
FO
FP
FQ
FR
FS
FT
FU
FV
FW
FX
FY
FZ
GA
GB
GC
GD
GE
GF
GG
GH
GI
GJ
GK
GL
GM
GN
GO
GP
GQ
GR
GS
GT
GU
GV
GW
GX
GY
GZ
HA
HB
HC
HD
HE
HF
HG
HH
HI
HJ
HK
HL
HM
HN
HO
HP
HQ
HR
HS
HT
HU
HV
HW
HX
HY
HZ
IA
IB
IC
ID
IE
IF
IG
IH
II
IJ
IK
IL
IM
IN
IO
IP
IQ
IR
IS
IT
IU
IV
IW
IX
IY
IZ
JA
JB
JC
JD
JE
JF
JG
JH
JI
JJ
JK
JL
JM
JN
JO
JP
JQ
JR
JS
JT
JU
JV
JW
JX
JY
JZ
KA
KB
KC
KD
KE
KF
KG
KH
KI
KJ
KK
KL
KM
KN
KO
KP
KQ
KR
KS
KT
KU
KV
KW
KX
KY
KZ
LA
LB
LC
LD
LE
LF
LG
LH
LI
LJ
LK
LL
LM
LN
LO
LP
LQ
LR
LS
LT
LU
LV
LW
LX
LY
LZ
MA
MB
MC
MD
ME
MF
MG
MH
MI
MJ
MK
ML
MM
MN
MO
MP
MQ
MR
MS
MT
MU
MV
MW
MX
MY
MZ
NA
NB
NC
ND
NE
NF
NG
NH
NI
NJ
NK
NL
NM
NN
NO
NP
NQ
NR
NS
NT
NU
NV
NW
NX
NY
NZ
OA
OB
OC
OD
OE
OF
OG
OH
OI
OJ
OK
OL
OM
ON
OO
OP
OQ
OR
OS
OT
OU
OV
OW
OX
OY
OZ
PA
PB
PC
PD
PE
PF
PG
PH
PI
PJ
PK
PL
PM
PN
PO
PP
PQ
PR
PS
PT
PU
PV
PW
PX
PY
PZ
QA
QB
QC
QD
QE
QF
QG
QH
QI
QJ
QK
QL
QM
QN
QO
QP
QQ
QR
QS
QT
QU
QV
QW
QX
QY
QZ
RA
RB
RC
RD
RE
RF
RG
RH
RI
RJ
RK
RL
RM
RN
RO
RP
RQ
RR
RS
RT
RU
RV
RW
RX
RY
RZ
SA
SB
SC
SD
SE
SF
SG
SH
SI
SJ
SK
SL
SM
SN
SO
SP
SQ
SR
SS
ST
SU
SV
SW
SX
SY
SZ
TA
TB
TC
TD
TE
TF
TG
TH
TI
TJ
TK
TL
TM
TN
TO
TP
TQ
TR
TS
TT
TU
TV
TW
TX
TY
TZ
UA
UB
UC
UD
UE
UF
UG
UH
UI
UJ
UK
UL
UM
UN
UO
UP
UQ
UR
US
UT
UU
UV
UW
UX
UY
UZ
VA
VB
VC
VD
VE
VF
VG
VH
VI
VJ
VK
VL
VM
VN
VO
VP
VQ
VR
VS
VT
VU
VV
VW
VX
VY
VZ
WA
WB
WC
WD
WE
WF
WG
WH
WI
WJ
WK
WL
WM
WN
WO
WP
WQ
WR
WS
WT
WU
WV
WW
WX
WY
WZ
XA
XB
XC
XD
XE
XF
XG
XH
XI
XJ
XK
XL
XM
XN
XO
XP
XQ
XR
XS
XT
XU
XV
XW
XX
XY
XZ
YA
YB
YC
YD
YE
YF
YG
YH
YI
YJ
YK
YL
YM
YN
YO
YP
YQ
YR
YS
YT
YU
YV
YW
YX
YY
YZ
ZA
ZB
ZC
ZD
ZE
ZF
ZG
ZH
ZI
ZJ
ZK
ZL
ZM
ZN
ZO
ZP
ZQ
ZR
ZS
ZT
ZU
ZV
ZW
ZX
ZY
ZZ

KA ORTHOPÄDIE ORTHOPAEDIC ORTOPEDIA ORTHOPEDIE ORTOPIA

Arthroskopie
Arthroscopy
Artroscopio
Arthroscopie
Artroscopia



KA 304/00
12,5 cm/5"

KA 304/13

KA 304/14

KA 304/15

KA 304/16

KA 304/17

KA 304/18

KA 304/19

Arthroskopie
Arthroscopy
Artroscopio
Arthroscopie
Artroscopia

- >> Bitte beachten Sie folgende Symbole für Arthroskopiezangen.
- >> Kindly note the following symbols for Arthroscopy Forceps.
- >> Tengan en cuenta los siguientes símbolos para pinzas de artroscopio.
- >> Veuillez noter les différentes spécifications pour les pinces arthroscopie.
- >> Notate le seguenti indicazioni per le pinze per artroscopia.

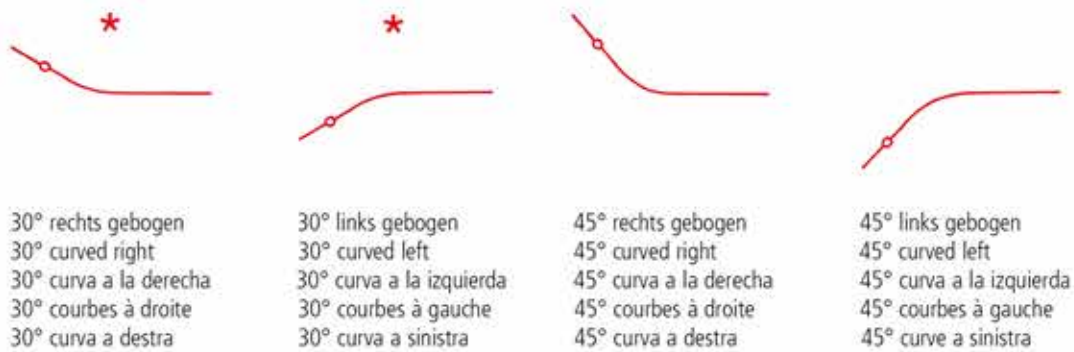

- * >> Standardbiegung beträgt 30°. Auf Anfrage sind auch andere Biegungen lieferbar.
- * >> Standard angle is 30°. Other angles are available on request.
- * >> Angulo standard del extremo 30°. Otros ángulos se pueden fabricar sobre pedido.
- * >> L'angle standard est de 30°. D'autres angles sont disponibles sur demande.
- * >> L'angolo standard è di 30°. Altre angolazioni sono disponibili su richiesta.

AA
AB
AC
AD
AE
AF
AK
AL
AM
AO
AP
AR
KA
KD
KU
KY

KA ORTHOPÄDIE ORTHOPAEDIC ORTOPEDIA ORTHOPEDIE ORTOPIEDIA

Arthroscopie
Arthroscopy
Artroscopio
Arthroscopie
Artroscopia



2/1

Ø 2,7 mm
Ø 3,4 mm
Ø 4,5 mm

KA 320/10	KA 320/11	KA 320/13	KA 320/15	KA 320/17	KA 320/19	KA 320/21	KA 320/21
KA 321/10	KA 321/11	KA 321/13	KA 321/15	KA 321/17	KA 321/19	KA 321/21	KA 321/21
KA 322/10	KA 322/11	KA 322/13	KA 322/15	KA 322/17	KA 322/19	KA 322/21	KA 322/21



2/1

Ø 2,7 mm
Ø 3,4 mm
Ø 4,5 mm

KA 323/10	KA 323/11	KA 323/13	KA 323/15	KA 323/17	KA 323/19	KA 323/21	KA 323/21
KA 324/10	KA 324/11	KA 324/13	KA 324/15	KA 324/17	KA 324/19	KA 324/21	KA 324/21
KA 325/10	KA 325/11	KA 325/13	KA 325/15	KA 325/17	KA 325/19	KA 325/21	KA 325/21



2/1

Ø 3,4 mm

KA 326/10	KA 326/11	KA 326/13	KA 326/15	KA 326/17	KA 326/19	KA 326/21	KA 326/21



2/1

Ø 3,4 mm

KA 327/10	KA 327/11	KA 327/13	KA 327/15	KA 327/17	KA 327/19	KA 327/21	KA 327/21

Arthroskopie
Arthroscopy
Artroscopio
Arthroscopie
Artroscopia



Mit Überlastungsschutz
With overload protection
Con protección para exceso de carga
Avec protection de surcharge
Con protezione incorporata



2/1

Ø 2,7 mm
Ø 3,4 mm
Ø 4,5 mm

KA 328/10	KA 328/11	KA 328/13	KA 328/15	KA 328/17	KA 328/19	KA 328/21	KA 328/21
KA 329/10	KA 329/11	KA 329/13	KA 329/15	KA 329/17	KA 329/19	KA 329/21	KA 329/21
KA 330/10	KA 330/11	KA 330/13	KA 330/15	KA 330/17	KA 330/19	KA 330/21	KA 330/21



2/1

Ø 2,7 mm
Ø 3,4 mm
Ø 4,5 mm

KA 331/10	KA 331/11	KA 331/13	KA 331/15	KA 331/17	KA 331/19	KA 331/21	KA 331/21
KA 332/10	KA 332/11	KA 332/13	KA 332/15	KA 332/17	KA 332/19	KA 332/21	KA 332/21
KA 333/10	KA 333/11	KA 333/13	KA 333/15	KA 333/17	KA 333/19	KA 333/21	KA 333/21



2/1

Ø 3,4 mm

KA 334/10	KA 334/11	KA 334/13	KA 334/15	KA 334/17	KA 334/19	KA 334/21	KA 334/21



2/1

Ø 3,4 mm

KA 335/10	KA 335/11	KA 335/13	KA 335/15	KA 335/17	KA 335/19	KA 335/21	KA 335/21

AA
AB
AC
AD
AE
AF
AK
AL
AM
AO
AP
AR
KA
KD
KU
KY

Arthroskopie
 Arthroscopy
 ArtroscoPIO
 Arthroscopie
 ArtroscoPIA

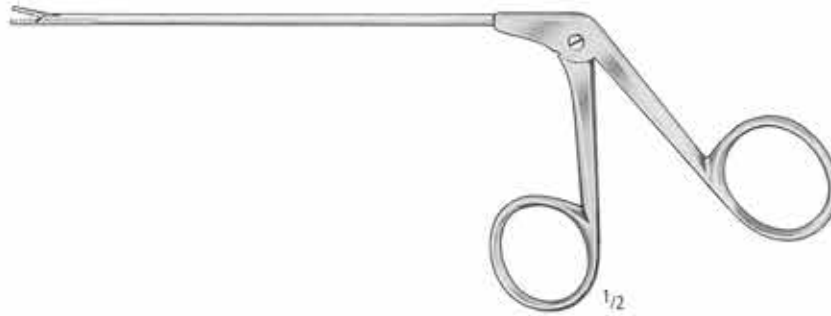

2/1

Ø 3,4 mm



KA 339/10

KA 339/11

KA 339/13

KA 339/15

KA 339/17

KA 339/19

KA 339/21

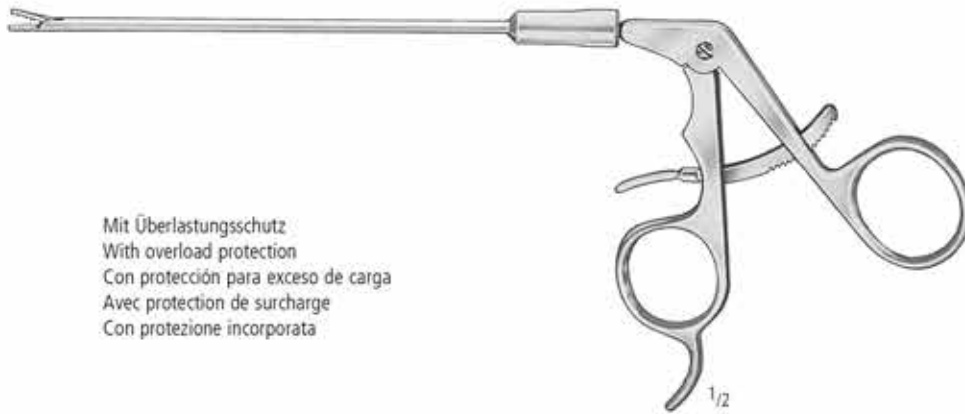

Mit Überlastungsschutz
 With overload protection
 Con protección para exceso de carga
 Avec protection de surcharge
 Con protezione incorporata



2/1

Ø 3,4 mm



KA 340/10

KA 340/11

KA 340/13

KA 340/15

KA 340/17

KA 340/19

KA 340/21

Arthroskopie
Arthroscopy
Artroscopio
Arthroscopie
Artroscopia



Ø 2,0 mm



KA 345/10



Ø 2,0 mm



KA 345/20



Ø 2,0 mm



KA 345/30



Ø 2,0 mm



KA 345/40

AA
AB
AC
AD
AE
AF
AK
AL
AM
AO
AP
AR
KA
KD
KU
KY

Maßtabelle
 Scale
 Tabla de medida
 Tableau de la mesure
 Scala



2,0 mm



3,0 mm



4,0 mm



5,0 mm



6,0 mm



8,0 mm



10,0 mm



12,0 mm



14,0 mm

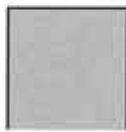

16,0 mm

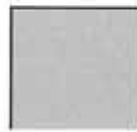

18,0 mm



20,0 mm



25,0 mm



30,0 mm



35,0 mm



40,0 mm



45,0 mm



50,0 mm

ORTHOPÄDIE ORTHOPAEDIC ORTOPEDIA ORTHOPEDIE ORTOPEDIA

Meißel und Osteotome
 Chisels, Gouges and Osteotomes
 Cinceles y Gubias
 Ciseaux-Burins et Ostéotomes
 Scalpelli, Osteotomi, Sgorbie



mm 13,5 cm/5 1/4"
 8 **KA 400/08**
 10 **KA 400/10**
 12 **KA 400/12**
 14 **KA 400/14**
 16 **KA 400/16**



mm 13,5 cm/5 1/4"
 8 **KA 401/08**
 10 **KA 401/10**
 12 **KA 401/12**
 14 **KA 401/14**
 16 **KA 401/16**



mm 13,5 cm/5 1/4"
 8 **KA 402/08**
 10 **KA 402/10**
 12 **KA 402/12**
 14 **KA 402/14**
 16 **KA 402/16**



mm **HOKE**
 14,0 cm/5 1/2"
 3 **KA 404/03**
 5 **KA 404/05**
 6 **KA 404/06**
 8 **KA 404/08**
 9 **KA 404/09**



mm **LUCAS**
 16,0 cm/6 1/4"
 4 **KA 406/04**
 6 **KA 406/06**



mm **LUCAS**
 16,0 cm/6 1/4"
 3 **KA 407/03**
 5 **KA 407/05**

AA
 AB
 AC
 AD
 AE
 AF
 AK
 AL
 AM
 AO
 AP
 AR
KA
 KD
 KU
 KY

Meißel und Osteotome
 Chisels, Gouges and Osteotomes
 Cinceles y Gubias
 Ciseaux-Burins et Ostéotomes
 Scalpelli, Osteotomi, Sgorbie

		
	ALEXANDER	
	18,0 cm/7"	
mm		
4	KA 418/04	
6	KA 418/06	
8	KA 418/08	
10	KA 418/10	
12	KA 418/12	
14	KA 418/14	

		
	ALEXANDER	
	18,0 cm/7"	
mm		
4	KA 419/04	
6	KA 419/06	
8	KA 419/08	
10	KA 419/10	
12	KA 419/12	
14	KA 419/14	



13,5 cm/5 ¹ / ₄ "	17,0 cm/6 ³ / ₄ "
KA 433/02	KA 437/02
KA 433/03	KA 437/03
KA 433/04	KA 437/04
KA 433/05	KA 437/05
KA 433/06	KA 437/06
KA 433/07	KA 437/07
KA 433/08	KA 437/08

PARTSCH

mm	13,5 cm/5 ¹ / ₄ "	17,0 cm/6 ³ / ₄ "
2	KA 443/02	KA 447/02
3	KA 443/03	KA 447/03
4	KA 443/04	KA 447/04
5	KA 443/05	KA 447/05
6	KA 443/06	KA 447/06
7	KA 443/07	KA 447/07
8	KA 443/08	KA 447/08

Meißel und Osteotome
 Chisels, Gouges and Osteotomes
 Cinceles y Gubias
 Ciseaux-Burins et Ostéotomes
 Scalpelli, Osteotomi, Sgorbie

AA
AB
AC
AD
AE
AF
AK
AL
AM
AO
AP
AR
KA
KD
KY



SMITH-PETERSEN
 20,0 cm/8"

mm	KA 450/06	KA 451/06	KA 452/09	KA 453/09
6	KA 450/06	KA 451/06		KA 453/09
9	KA 450/09	KA 451/09	KA 452/09	
13	KA 450/13	KA 451/13		KA 453/14
14			KA 452/14	
16	KA 450/16	KA 451/16		KA 453/19
19	KA 450/19	KA 451/19	KA 452/19	KA 453/19
25	KA 450/25	KA 451/25	KA 452/25	KA 453/25
32	KA 450/32	KA 451/32		

Meißel und Osteotome
 Chisels, Gouges and Osteotomes
 Cinceles y Gubias
 Ciseaux-Burins et Ostéotomes
 Scalpelli, Osteotomi, Sgorbie

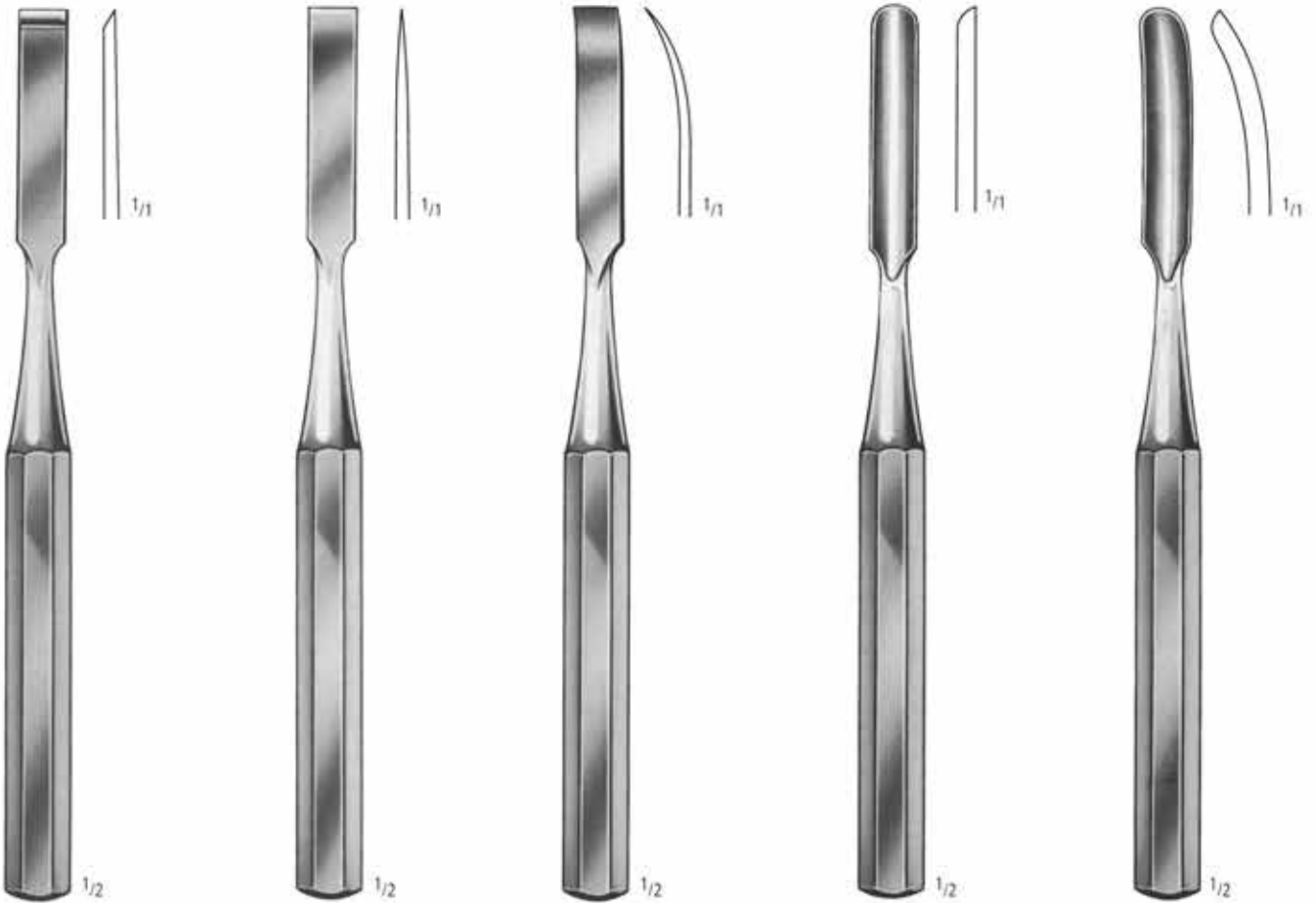

HIBBS
 24,0 cm/9 1/2"

mm	KA 455/06	KA 456/06	KA 457/06	KA 458/06	KA 459/06
6	KA 455/13	KA 456/13	KA 457/13	KA 458/13	KA 459/13
13	KA 455/19	KA 456/19	KA 457/19	KA 458/19	KA 459/19
19	KA 455/25	KA 456/25	KA 457/25	KA 458/25	KA 459/25
25	KA 455/32	KA 456/32	KA 457/32	KA 458/32	KA 459/32
32					

Meißel und Osteotome
 Chisels, Gouges and Osteotomes
 Cinceles y Gubias
 Ciseaux-Burins et Ostéotomes
 Scalpelli, Osteotomi, Sgorbie



STILLE
 20,0 cm/8"

mm
 4
 6
 8
 10
 15
 20
 25

KA 460/08
 KA 460/10
 KA 460/15
 KA 460/20
 KA 460/25

KA 461/04
 KA 461/06
 KA 461/08
 KA 461/10
 KA 461/15
 KA 461/20
 KA 461/25

KA 462/08
 KA 462/10
 KA 462/15
 KA 462/20
 KA 462/25

KA 463/08
 KA 463/10
 KA 463/15
 KA 463/20
 KA 463/25

AA
 AB
 AC
 AD
 AE
 AF
 AG
 AH
 AI
 AJ
 AK
 AL
 AM
 AN
 AO
 AP
 AQ
 AR
 AS
 AT
 AU
 AV
 AW
 AX
 AY
 AZ

KA

KD

KU

KV

Meißel und Osteotome
Chisels, Gouges and Osteotomes
Cinceles y Gubias
Ciseaux-Burins et Ostéotomes
Scalpelli, Osteotomi, Sgorbie



MINI-LEXER
18,0 cm/7"



MINI-LEXER
18,0 cm/7"



LEXER
22,0 cm/8³/₄"



LEXER
22,0 cm/8³/₄"

mm
4
6
7
8
10
12
15
20
25
30

KA 470/04
KA 470/06
KA 470/08
KA 470/10
KA 470/12
KA 470/15
KA 470/20

KA 471/04
KA 471/06
KA 471/08
KA 471/10
KA 471/12
KA 471/15
KA 471/20

KA 472/07
KA 472/10
KA 472/15
KA 472/20
KA 472/25
KA 472/30

KA 473/07
KA 473/10
KA 473/15
KA 473/20
KA 473/25
KA 473/30

Ferrozellgriff
Hartpress-Handle
Mango en "Ferrozell"
Manche en "Ferrozell"
Manico in "Ferrozell"

Meißel und Osteotome
 Chisels, Gouges and Osteotomes
 Cinceles y Gubias
 Ciseaux-Burins et Ostéotomes
 Scalpelli, Osteotomi, Sgorbie



LEXER
 27,5 cm/10³/₄"

- mm
 5
 10 **KA 474/10**
 15 **KA 474/15**



LEXER
 27,5 cm/10³/₄"

- KA 475/10**
KA 475/15



LEXER
 25,0 cm/10"

- KA 476/05**
KA 476/10
KA 476/15



LEXER
 25,0 cm/10"

- KA 477/05**
KA 477/10
KA 477/15

Ferrozellgriff
 Hartpress-Handle
 Mango en "Ferrozell"
 Manche en "Ferrozell"
 Manico in "Ferrozell"

AA
 AB
 AC
 AD
 AE
 AF
 AK
 AL
 AM
 AO
 AP
 AR
KA
 KD
 KU
 KV

Meißel und Osteotome
 Chisels, Gouges and Osteotomes
 Cinceles y Gubias
 Ciseaux-Burins et Ostéotomes
 Scalpelli, Osteotomi, Sgorbie



COBB
 28,0 cm/11"

KA 478/01



COBB
 28,0 cm/11"

KA 478/02



COBB
 28,0 cm/11"

KA 478/03

















COBB
 28,0 cm/11"

KA 478/04

ORTHOPÄDIE ORTHOPAEDIC ORTOPEDIA ORTHOPEDIE ORTOPEDIA

Meißel und Osteotome
 Chisels, Gouges and Osteotomes
 Cinceles y Gubias
 Ciseaux-Burins et Ostéotomes
 Scalpelli, Osteotomi, Sgorbie



					
	4 mm	KA 479/01	KA 479/02	KA 479/03	KA 479/04
		KA 479/05	KA 479/06	KA 479/07	KA 479/08
		KA 479/09	KA 479/10	KA 479/11	KA 479/12
		KA 479/13	KA 479/14	KA 479/15	KA 479/16
		KA 479/17	KA 479/18	KA 479/19	KA 479/20
		KA 479/21	KA 479/22	KA 479/23	KA 479/24
		KA 479/25	KA 479/26	KA 479/27	KA 479/28
		KA 479/29	KA 479/30	KA 479/31	KA 479/32
		KA 479/33	KA 479/34	KA 479/35	KA 479/36
		KA 479/37	KA 479/38	KA 479/39	KA 479/40

DAHMEN

30,0 cm/12"

Ferrozellgriff
 Hartpress-Handle
 Mango en "Ferrozell"
 Manche en "Ferrozell"
 Manico in "Ferrozell"

AA
AB
AC
AD
AE
AF
AK
AL
AM
AO
AP
AR
KA
KD
KU
KY

Meißel und Osteotome
 Chisels, Gouges and Osteotomes
 Cinceles y Gubias
 Ciseaux-Burins et Ostéotomes
 Scalpelli, Osteotomi, Sgorbie

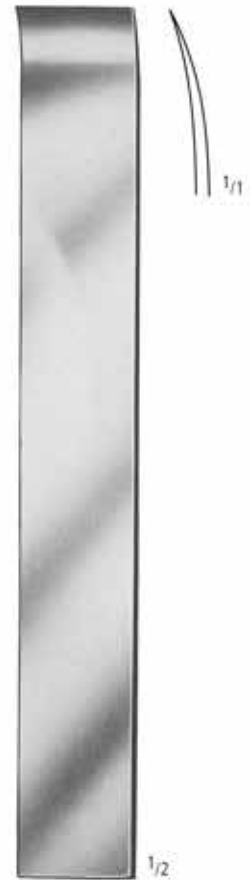

MINI-LAMBOTTE
 12,5 cm/5"

MINI-LAMBOTTE
 17,0 cm/6³/₄"

LAMBOTTE
 24,0 cm/9¹/₂"

LAMBOTTE
 23,0 cm/9"

mm	
3	KA 480/03
4	KA 480/04
6	KA 480/06
8	KA 480/08
10	KA 480/10
12	KA 480/12
15	KA 480/15

KA 481/03
KA 481/04
KA 481/06
KA 481/08
KA 481/10
KA 481/12
KA 481/15

mm	
15	KA 482/15
20	KA 482/20
25	KA 482/25
30	KA 482/30
38	KA 482/38
44	KA 482/44
50	KA 482/50

KA 483/15
KA 483/20
KA 483/25
KA 483/30
KA 483/38
KA 483/44
KA 483/50

Hämmer
Mallets
Martillos
Marteaux
Martelli



300 g
(10³/₄ oz.)

BERGMANN
KA 517/30
24,0 cm/9¹/₂"



300 g
(10³/₄ oz.)

BERGMANN
KA 518/30
23,0 cm/9"



550 g
(19¹/₂ oz.)

OMBREDANNE
KA 519/55
24,0 cm/9¹/₂"

AA
AB
AC
AD
AE
AF
AK
AL
AM
AO
AP
AR
KA
KD
KU
KY

KA

Hämmer
Mallets
Martillos
Marteaux
Martelli



KA 520/30
Ø 26 mm
300 g (10³/₄ oz.)

KA 520/34
Ø 28 mm
340 g (12 oz.)

KA 520/40
Ø 30 mm
400 g (14¹/₄ oz.)

WILLIGER
24,0 cm/9¹/₂"



KA 530/12
Ø 25 mm
120 g (4¹/₄ oz.)

KA 530/18
Ø 30 mm
180 g (6¹/₂ oz.)

KA 530/26
Ø 35 mm
260 g (9¹/₄ oz.)

DOYEN
20,0 cm/8¹/₄"



COTTLE
KA 531/24
19,0 cm/7¹/₂"
240 g (8¹/₂ oz.)

Hämmer
Mallets
Martillos
Marteaux
Martelli



Ø 30 mm
220 g
(7³/₄ oz.)

COLLIN
KA 532/22
20,0 cm/8"



Ø 27 mm
140 g
(5 oz.)

HAJEK
KA 533/14
22,0 cm/8³/₄"



Ø 25 mm
140 g
(5 oz.)

KA 534/14
18,0 cm/7"

AA

AB

AC

AD

AE

AF

AK

AL

AM

AO

AP

AR

KA

KD

KU

KY

Hämmer
Mallets
Martillos
Marteaux
Martelli

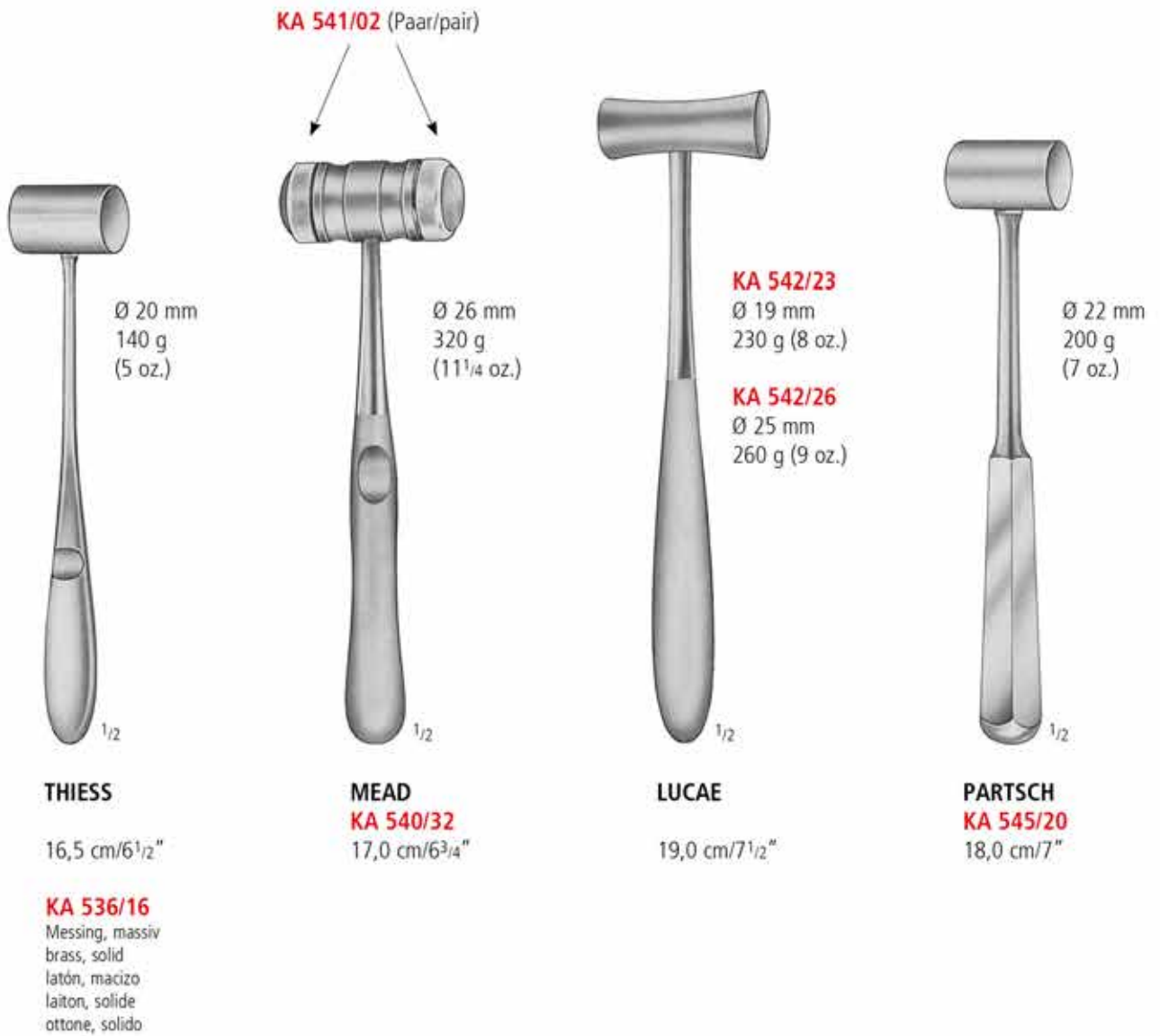

Hämmer
Mallets
Martillos
Marteaux
Martelli



450 g
(16 oz.)

KA 546/45
26,5 cm/10¹/₂"



900 g
(32 oz.)

KA 546/90
26,5 cm/10¹/₂"

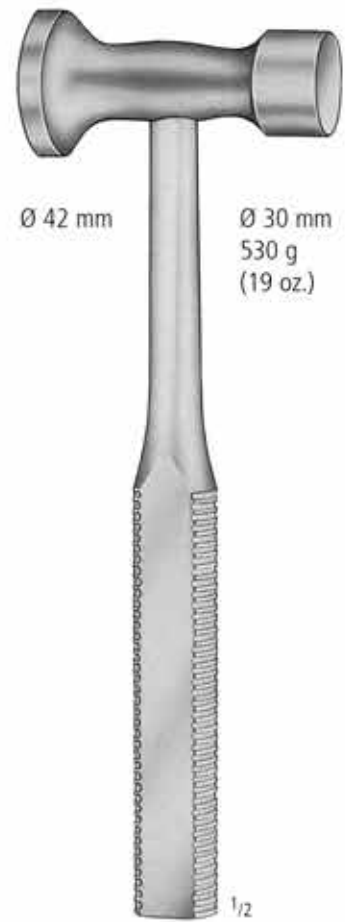

Ø 42 mm

Ø 30 mm
530 g
(19 oz.)

KA 550/53
24,0 cm/9¹/₂"

AA

AB

AC

AD

AE

AF

AK

AL

AM

AO

AP

AR

KA

KD

KU

KV

Hämmer
Mallets
Martillos
Marteaux
Martelli



Ø 80 x 60 mm
400 g
(14¹/₄ oz.)

STEINBACH
KA 551/40
24,0 cm/9¹/₂"



Ø 45 mm
290 g
(10¹/₂ oz.)

KA 552/29
23,0 cm/9"



KA 553/35
Ø 35 mm

KA 553/42
Ø 42 mm

KA 553/50
Ø 50 mm

25,0 cm/10"

Hämmer
Mallets
Martillos
Marteaux
Martelli



KA 554/90



KA 554/37
370 g (12³/₄ oz.)
oz.)
Ferrozell



KA 555/13
125 g (4¹/₄)
Ferrozell

AA
AB
AC
AD
AE
AF
AK
AL
AM
AO
AP
AR
KA
KD
KU
KY

Scharfe Löffel
 Bone Currettes
 Cucharillas cortantes
 Curettes tranchantes
 Curette taglienti



VOLKMANN
 17,0 cm/6³/₄"



Fig. 0000
KA 600/00



Fig. 000
KA 601/00



Fig. 00
KA 602/00



Fig. 0
KA 603/00



Fig. 1
KA 603/01



Fig. 2
KA 603/02



Fig. 3
KA 603/03



Fig. 4
KA 603/04



Fig. 5
KA 603/05



Fig. 6
KA 603/06

¹/₁



BRUNS
 17,0 cm/6³/₄"



Fig. 000
KA 610/00



Fig. 00
KA 611/00



Fig. 0
KA 612/00



Fig. 1
KA 612/01



Fig. 2
KA 612/02



Fig. 3
KA 612/03



Fig. 4
KA 612/04



Fig. 5
KA 612/05



Fig. 6
KA 612/06

¹/₁

Scharfe Löffel
 Bone Curettes
 Cucharillas cortantes
 Curettes tranchantes
 Curette taglienti



SCHEIDE
 17,0 cm/6³/₄"



Fig. 000
KA 615/00



Fig. 00
KA 616/00



Fig. 0
KA 617/00



Fig. 1
KA 617/01



Fig. 2
KA 617/02



Fig. 3
KA 617/03



Fig. 4
KA 617/04



Fig. 5
KA 617/05



SPRATT
 17,0 cm/6³/₄"



Fig. 000
KA 620/00



Fig. 00
KA 621/00



Fig. 0
KA 622/00



Fig. 1
KA 622/01



Fig. 2
KA 622/02



Fig. 3
KA 622/03



Fig. 4
KA 622/04

AA
 AB
 AC
 AD
 AE
 AF
 AG
 AH
 AI
 AJ
 AK
 AL
 AM
 AN
 AO
 AP
 AQ
 AR
 AS
 AT
 AU
 AV
 AW
 AX
 AY
 AZ

KA

Scharfe Löffel
 Bone Currettes
 Cucharillas cortantes
 Curettes tranchantes
 Curette taglienti



2 mm
KA 623/02



3 mm
KA 623/03



4 mm
KA 623/04



5 mm
KA 623/05



6 mm
KA 623/06



3 mm
KA 623/13



4 mm
KA 623/14



5 mm
KA 623/15



6 mm
KA 623/16



FOX



PIFFARD



4 mm
KA 624/01



5 mm
KA 624/02



6 mm
KA 624/03

Scharfe Löffel
Bone Curettes
Cucharillas cortantes
Curettes tranchantes
Curette taglienti



BRUNS
23,0 cm/9"

Fig. 000
KA 625/00

Fig. 00
KA 625/01

Fig. 0
KA 625/02

Fig. 1
KA 625/03

Fig. 2
KA 625/04

Fig. 3
KA 625/05

Fig. 4
KA 625/06

Fig. 5
KA 625/07

Fig. 6
KA 625/08



**CLOWARD
HIBBS SPRATT
SPINAL FUSION**
22,5 cm/9"

Fig. 000
KA 626/00

Fig. 00
KA 627/00

Fig. 0
KA 628/00

Fig. 1
KA 628/01

Fig. 2
KA 628/02

Fig. 3
KA 628/03

Fig. 4
KA 628/04

Fig. 5
KA 628/05

Fig. 6
KA 628/06



**CLOWARD
HIBBS SPRATT
SPINAL FUSION**
22,5 cm/9"

Fig. 000
KA 629/00

Fig. 00
KA 630/00

Fig. 0
KA 631/00

Fig. 1
KA 631/01

Fig. 2
KA 631/02

Fig. 3
KA 631/03

Fig. 4
KA 631/04

Fig. 5
KA 631/05

Fig. 6
KA 631/06

AA
AB
AC
AD
AE
AF
AG
AH
AI
AJ
AK
AL
AM
AN
AO
AP
AQ
AR
AS
AT
AU
AV
AW
AX
AY
AZ
BA
BB
BC
BD
BE
BF
BG
BH
BI
BJ
BK
BL
BM
BN
BO
BP
BQ
BR
BS
BT
BU
BV
BW
BX
BY
BZ
CA
CB
CC
CD
CE
CF
CG
CH
CI
CJ
CK
CL
CM
CN
CO
CP
CQ
CR
CS
CT
CU
CV
CW
CX
CY
CZ
DA
DB
DC
DD
DE
DF
DG
DH
DI
DJ
DK
DL
DM
DN
DO
DP
DQ
DR
DS
DT
DU
DV
DW
DX
DY
DZ
EA
EB
EC
ED
EE
EF
EG
EH
EI
EJ
EK
EL
EM
EN
EO
EP
EQ
ER
ES
ET
EU
EV
EW
EX
EY
EZ
FA
FB
FC
FD
FE
FF
FG
FH
FI
FJ
FK
FL
FM
FN
FO
FP
FQ
FR
FS
FT
FU
FV
FW
FX
FY
FZ
GA
GB
GC
GD
GE
GF
GG
GH
GI
GJ
GK
GL
GM
GN
GO
GP
GQ
GR
GS
GT
GU
GV
GW
GX
GY
GZ
HA
HB
HC
HD
HE
HF
HG
HH
HI
HJ
HK
HL
HM
HN
HO
HP
HQ
HR
HS
HT
HU
HV
HW
HX
HY
HZ
IA
IB
IC
ID
IE
IF
IG
IH
II
IJ
IK
IL
IM
IN
IO
IP
IQ
IR
IS
IT
IU
IV
IW
IX
IY
IZ
JA
JB
JC
JD
JE
JF
JG
JH
JI
JJ
JK
JL
JM
JN
JO
JP
JQ
JR
JS
JT
JU
JV
JW
JX
JY
JZ
KA
KB
KC
KD
KE
KF
KG
KH
KI
KJ
KK
KL
KM
KN
KO
KP
KQ
KR
KS
KT
KU
KV
KW
KX
KY
KZ
LA
LB
LC
LD
LE
LF
LG
LH
LI
LJ
LK
LL
LM
LN
LO
LP
LQ
LR
LS
LT
LU
LV
LW
LX
LY
LZ
MA
MB
MC
MD
ME
MF
MG
MH
MI
MJ
MK
ML
MM
MN
MO
MP
MQ
MR
MS
MT
MU
MV
MW
MX
MY
MZ
NA
NB
NC
ND
NE
NF
NG
NH
NI
NJ
NK
NL
NM
NN
NO
NP
NQ
NR
NS
NT
NU
NV
NW
NX
NY
NZ
OA
OB
OC
OD
OE
OF
OG
OH
OI
OJ
OK
OL
OM
ON
OO
OP
OQ
OR
OS
OT
OU
OV
OW
OX
OY
OZ
PA
PB
PC
PD
PE
PF
PG
PH
PI
PJ
PK
PL
PM
PN
PO
PP
PQ
PR
PS
PT
PU
PV
PW
PX
PY
PZ
QA
QB
QC
QD
QE
QF
QG
QH
QI
QJ
QK
QL
QM
QN
QO
QP
QQ
QR
QS
QT
QU
QV
QW
QX
QY
QZ
RA
RB
RC
RD
RE
RF
RG
RH
RI
RJ
RK
RL
RM
RN
RO
RP
RQ
RR
RS
RT
RU
RV
RW
RX
RY
RZ
SA
SB
SC
SD
SE
SF
SG
SH
SI
SJ
SK
SL
SM
SN
SO
SP
SQ
SR
SS
ST
SU
SV
SW
SX
SY
SZ
TA
TB
TC
TD
TE
TF
TG
TH
TI
TJ
TK
TL
TM
TN
TO
TP
TQ
TR
TS
TT
TU
TV
TW
TX
TY
TZ
UA
UB
UC
UD
UE
UF
UG
UH
UI
UJ
UK
UL
UM
UN
UO
UP
UQ
UR
US
UT
UU
UV
UW
UX
UY
UZ
VA
VB
VC
VD
VE
VF
VG
VH
VI
VJ
VK
VL
VM
VN
VO
VP
VQ
VR
VS
VT
VU
VV
VW
VX
VY
VZ
WA
WB
WC
WD
WE
WF
WG
WH
WI
WJ
WK
WL
WM
WN
WO
WP
WQ
WR
WS
WT
WU
WV
WW
WX
WY
WZ
XA
XB
XC
XD
XE
XF
XG
XH
XI
XJ
XK
XL
XM
XN
XO
XP
XQ
XR
XS
XT
XU
XV
XW
XX
XY
XZ
YA
YB
YC
YD
YE
YF
YG
YH
YI
YJ
YK
YL
YM
YN
YO
YP
YQ
YR
YS
YT
YU
YV
YW
YX
YY
YZ
ZA
ZB
ZC
ZD
ZE
ZF
ZG
ZH
ZI
ZJ
ZK
ZL
ZM
ZN
ZO
ZP
ZQ
ZR
ZS
ZT
ZU
ZV
ZW
ZX
ZY
ZZ

Scharfe Löffel
 Bone Currettes
 Cucharillas cortantes
 Curettes tranchantes
 Curette taglienti



25,0 cm/9³/₄"

3,6 mm
KA 632/00

4,4 mm
KA 632/01

5,2 mm
KA 632/02

6,0 mm ^{1/11}
KA 632/03



25,0 cm/9³/₄"

3,6 mm
KA 633/00

4,4 mm
KA 633/01

5,2 mm
KA 633/02

6,0 mm ^{1/11}
KA 633/03

Scharfe Löffel
Bone Curettes
Cucharillas cortantes
Curettes tranchantes
Curette taglienti



HATFIELD
23,0 cm/9"

3,00 x 5,00 mm
KA 634/00

3,50 x 5,50 mm
KA 634/01

4,50 x 6,40 mm
KA 634/02

5,00 x 8,00 mm
KA 634/03

6,00 x 9,00 mm
KA 634/04

7,00 x 11,00 mm
KA 634/05

8,50 x 12,50 mm
KA 634/06

9,50 x 14,50 mm
KA 634/07

10,50 x 16,80 mm
KA 634/08



HATFIELD
28,0 cm/11"

3,00 x 5,00 mm
KA 635/00

3,50 x 5,50 mm
KA 635/01

4,50 x 6,40 mm
KA 635/02

5,00 x 8,00 mm
KA 635/03

6,00 x 9,00 mm
KA 635/04

7,00 x 11,00 mm
KA 635/05

8,50 x 12,50 mm
KA 635/06

9,50 x 14,50 mm
KA 635/07

10,50 x 16,80 mm
KA 635/08



COBB
28,0 cm/11"

4,06 x 5,08 mm
KA 636/00

5,08 x 6,35 mm
KA 636/01

6,10 x 7,62 mm
KA 636/02

7,11 x 8,89 mm
KA 636/03

8,13 x 10,16 mm
KA 636/04

9,14 x 11,43 mm
KA 636/05

10,16 x 12,70 mm
KA 636/06

11,18 x 13,97 mm
KA 636/07

12,19 x 15,24 mm
KA 636/08

AA
AB
AC
AD
AE
AF
AK
AL
AM
AO
AP
AR
KA
KD
KU
KY

Scharfe Löffel
Bone Currettes
Cucharillas cortantes
Currettes tranchantes
Curette taglienti

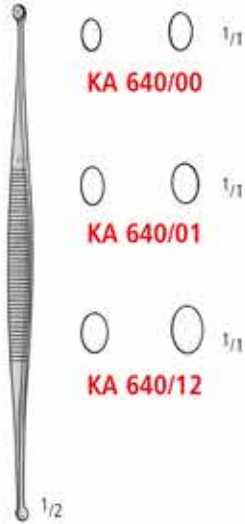

KA 640/00

KA 640/01

KA 640/12

WILLIGER
13,5 cm/5¹/₄"

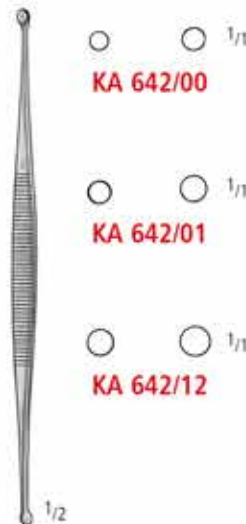

KA 642/00

KA 642/01

KA 642/12

MARTINI
13,5 cm/5¹/₄"



JANSEN
KA 644/16
16,0 cm/6¹/₄"



JANSEN
KA 645/15
15,0 cm/6"



KA 648/21
21,0 cm/8¹/₄"



KA 650/13
13,0 cm/5"

KA 650/14
14,0 cm/5¹/₂"

VOLKMANN **KA 650/17**
17,0 cm/6³/₄"

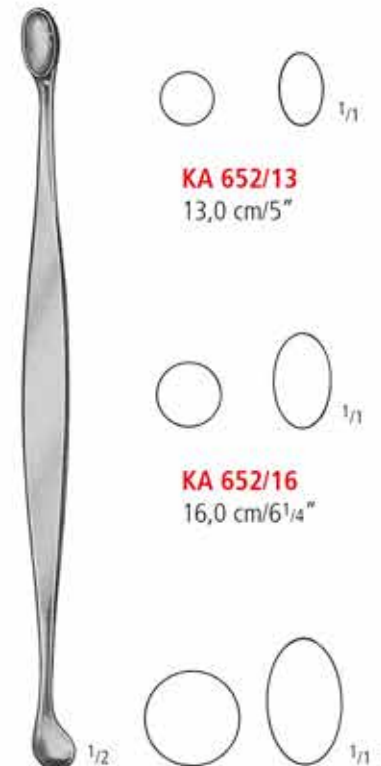

KA 652/13
13,0 cm/5"

KA 652/16
16,0 cm/6¹/₄"

VOLKMANN **KA 652/20**
20,0 cm/8"

Scharfe Löffel
 Bone Curettes
 Cucharillas cortantes
 Curettes tranchantes
 Curette taglienti



HEMINGWAY
 19,0 cm/7 1/2"

1/1

KA 654/11
 19,0 cm/7 1/2"



KA 654/22
 19,0 cm/7 1/2"



KA 654/33
 19,0 cm/7 1/2"



LUCAS
 17,0 cm/6 3/4"



KA 654/85
 17,0 cm/6 3/4"



KA 654/87
 17,0 cm/6 3/4"

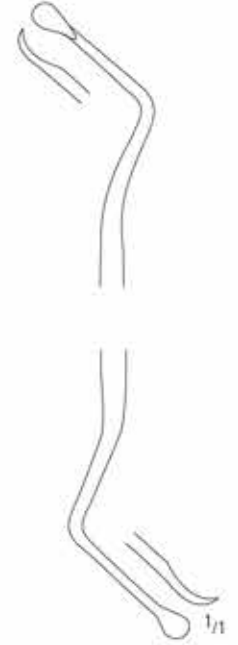

KA 654/86
 17,0 cm/6 3/4"



KA 654/88
 17,0 cm/6 3/4"

Raspatorien
Raspatories
Raspadores
Rugines-Raspatoires
Periostotomi



KA 660/20
20,0 cm/8"



KA 661/20
20,0 cm/8"



KA 662/20
20,0 cm/8"



KA 664/19
19,0 cm/7 1/2"



KA 665/18
18,0 cm/7"



KA 666/18
18,0 cm/7"



KA 667/18
18,0 cm/7"



KA 668/18
18,0 cm/7"

ORTHOPÄDIE ORTHOPAEDIC ORTOPEDIA ORTHOPEDIE ORTOPEDIA

Raspatorien
Raspatories
Raspadores
Rugines-Raspatoires
Periostotomi

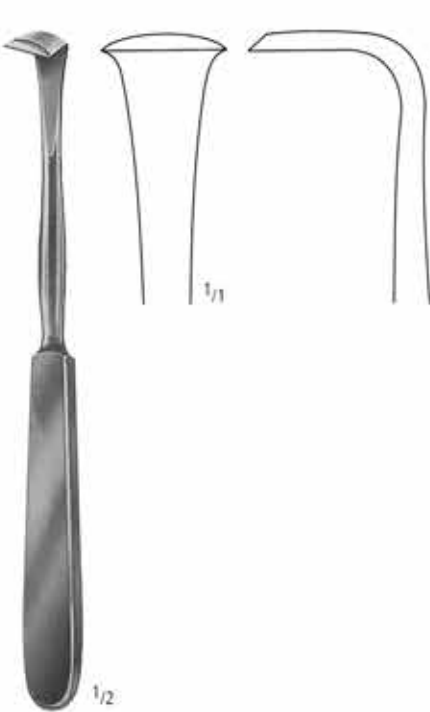

LANGENBECK
KA 671/18
18,0 cm/7"

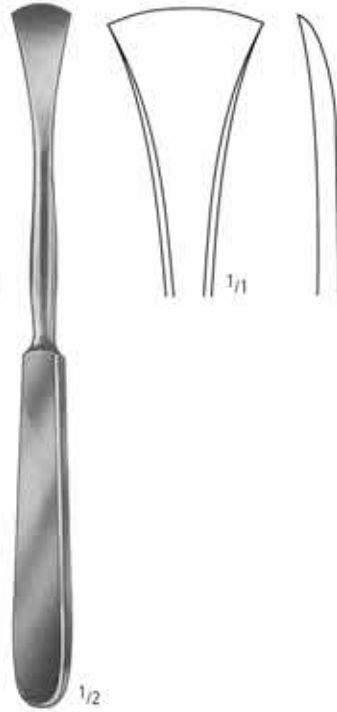

LANGENBECK
KA 672/19
19,0 cm/7 1/2"



CUSHING
KA 673/15
15,0cm/6"



LAMBOTTE
21,0 cm/8 1/4"

- 5 mm
KA 677/05
- 10 mm
KA 677/10
- 15 mm
KA 677/15
- 20 mm
KA 677/20
- 25 mm
KA 677/25

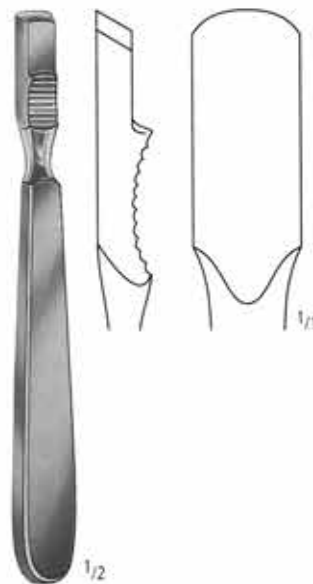

FARABEU
KA 678/15
15,0 cm/6"

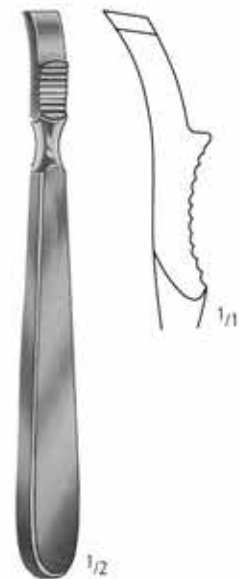

FARABEU
KA 679/15
15,0 cm/6"

AA
AB
AC
AD
AE
AF
AK
AL
AM
AO
AP
AR
KA
KD
KU
KY

Raspatorien
 Raspatories
 Raspadores
 Rugines-Raspatoires
 Periostotomi

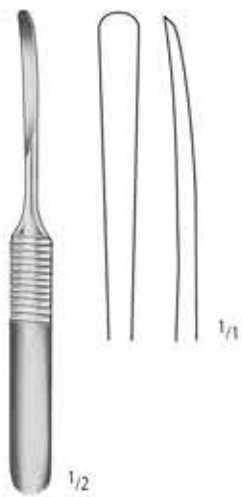

WILLIGER
KA 680/13
 13,0 cm/5"

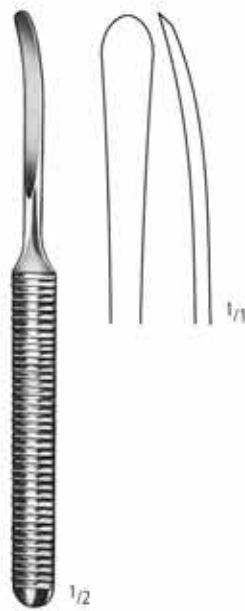

WILLIGER
KA 680/16
 16,0 cm/6 1/4"

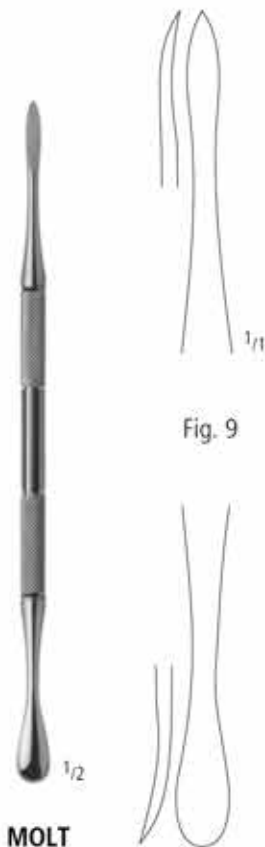

MOLT
KA 682/09
 18,0 cm/7"

Raspatorien
Raspatories
Raspadores
Rugines-Raspatoires
Periostotomi



DOYEN

17,0 cm/6³/₄"

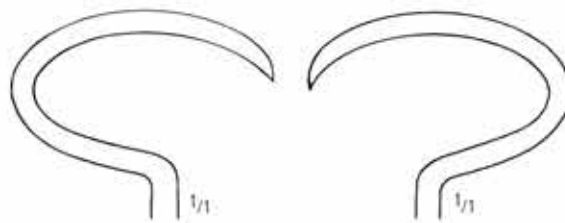

KA 681/17

KA 683/17

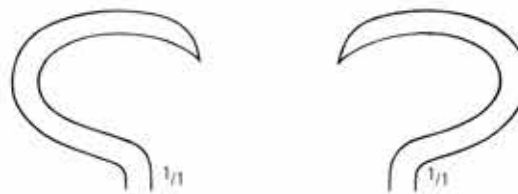

KA 685/17

KA 687/17



SEDILLOT

KA 688/21

21,0 cm/8¹/₄"

AA
AB
AC
AD
AE
AF
AK
AL
AM
AO
AP
AR
KA
KD
KU
KY

Raspatorien
 Raspatories
 Raspadores
 Rugines-Raspatoires
 Periostotomi



SEMB



KA 689/01
 17,5 cm/7"



KA 689/02
 21,0 cm/8¹/₄"



KA 689/03
 17,5 cm/7"



KA 689/04
 21,0 cm/8¹/₄"



KA 689/05
 20,5 cm/8"



ALEXANDER
KA 689/20
 20,0 cm/8"



MATSON
KA 689/22
 22,0 cm/8³/₄"

Elevatori
Elevators
Elevadores
Élévateurs
Elevatori

6 mm

KA 690/06

8 mm

KA 690/08

10 mm

KA 690/10

11 mm

**LANGENBECK
KA 691/11
23,0 cm/9"**

**LANGENBECK
19,5 cm/7³/₄"**

5 mm

**WILLIGER
KA 692/16
16,0 cm/6¹/₄"**

5,5 mm

**WILLIGER
KA 694/17
17,0 cm/6³/₄"**

5 mm

**SEBILEAU
KA 695/05
17,5 cm/7"**

AA
AB
AC
AD
AE
AF
AK
AL
AM
AO
AP
AR
KA
KD
KU
KY

Elevatoren
Elevators
Elevadores
Elévateurs
Elevatori



KA 696/17
17,5 cm/6³/₄"



KA 698/16
16,0 cm/6¹/₄"



ALDERDYCE
KA 699/21
21,0 cm/8¹/₄"



McDONALD
KA 700/19
19,0 cm/7¹/₂"



KA 701/19
scharf
sharp
cortante
tranchant
tagliente

KA 702/19
stumpf
blunt
romo
mousse
smusso

FREER
19,0 cm/7¹/₂"



FREER
KA 703/18
18,0 cm/7"

Elevatori
Elevators
Elevadores
Élévateurs
Elevatori

AA
AB
AC
AD
AE
AF
AK
AL
AM
AO
AP
AR
KA
KD
KU
KY

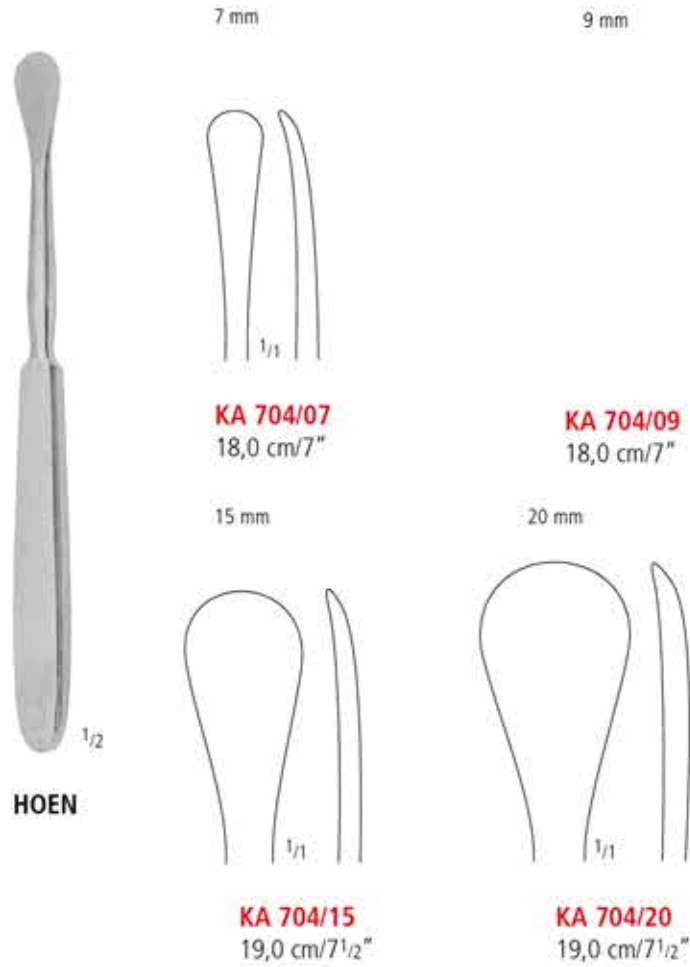

HOEN



ADSON
17,0 cm/6 3/4"

Elevatoren
Elevators
Elevadores
Elévateurs
Elevatori



STILLER
KA 707/08
18,0 cm/7"



STILLER
KA 707/18
18,0 cm/7"



STILLER
KA 707/22
22,0 cm/8³/₄"



STILLER
KA 707/33
20,0 cm/8"
3,0 mm



STILLER
KA 707/34
20,0 cm/8"
4,0 mm



STILLER
KA 707/36
20,0 cm/8"
6,0 mm



STILLER
KA 707/43
20,0 cm/8"

Elevatori
Elevators
Elevadores
Élévateurs
Elevatori

AA
AB
AC
AD
AE
AF
AK
AL
AM
AO
AP
AR
KA
KD
KU
KY



KA 708/01



KA 708/02

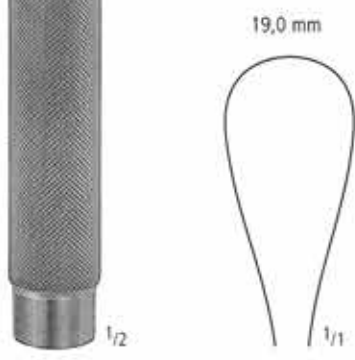

KA 708/03

COBB
28,0 cm/11"



KA 710/22
22,0 cm/8³/₄"



KA 711/24
24,5 cm/9³/₄"

Knochenfeilen
 Bone Files
 Limas para huesos
 Limes à os
 Lime per ossa

20,0 mm



KA 712/28
 28,0 cm/11"



PUTTI
KA 715/27
 27,0 cm/10¹/₂"



PUTTI
KA 715/30
 30 cm/12"

Raspeln, Stössel
 Rasps, Tampers
 Escofinas, Punzón
 Râpes, Pîlons
 Raspe, Pestoni



15,5 cm/6"

● 1/1
 Ø 2 mm
KA 720/02

● 1/1
 Ø 3 mm
KA 720/03

● 1/1
 Ø 4 mm
KA 720/04

● 1/1
 Ø 5 mm
KA 720/05

● 1/1
 Ø 6 mm
KA 720/06

● 1/1
 Ø 8 mm
KA 720/08

● 1/1
 Ø 10 mm
KA 720/10



20,0 cm/8"

● 1/1
 Ø 3 mm
KA 721/03

● 1/1
 Ø 5 mm
KA 721/05

● 1/1
 Ø 8 mm
KA 721/08

AA
AB
AC
AD
AE
AF
AG
AH
AI
AJ
AK
AL
AM
AN
AO
AP
AQ
AR
AS
AT
AU
AV
AW
AX
AY
AZ

KA

Knochenhalte­zangen
Bone Holding Forceps
Pinzas para huesos
Daviers porte-os
Tenaglie per ossa



KA 730/00
14,0 cm/5 1/2"



KA 731/00
13,5 cm/5 1/4"



KA 732/00
12,0 cm/4 3/4"



20,0 cm/8"

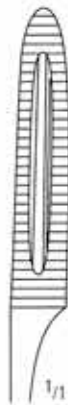

KA 734/20

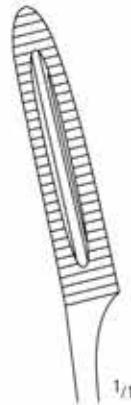

KA 735/20



VAN BUREN
KA 736/23
23,0 cm/9"



Meniskus- und Knorpelfasszangen
 Meniscus- and Cartilage Forceps
 Pinzas para cartilago y menisco
 Daviers à ménisques et cartilage
 Pinze per afferrare menisci e cartilagine

AA
AB
AC
AD
AE
AF
AK
AL
AM
AO
AP
AR
KA
KD
KU
KY

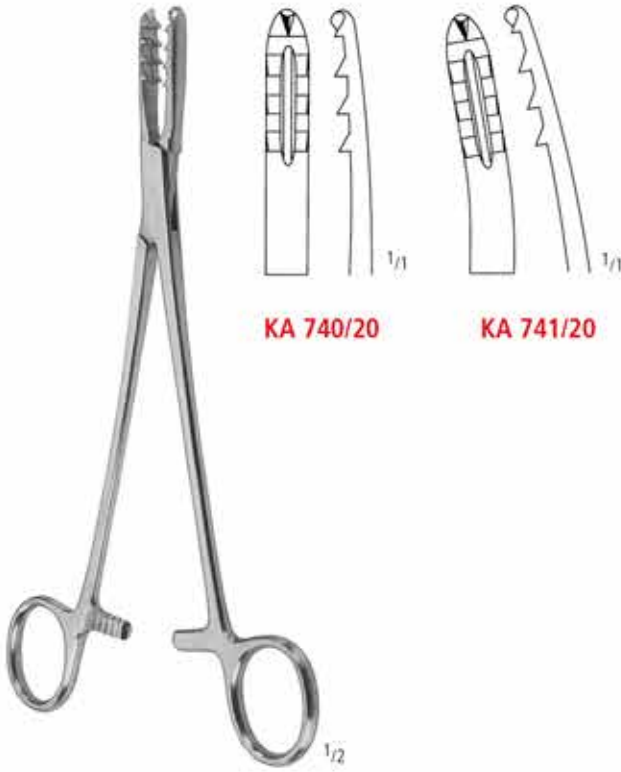

BIRCHER-GANSKE
 20,0 cm/8"

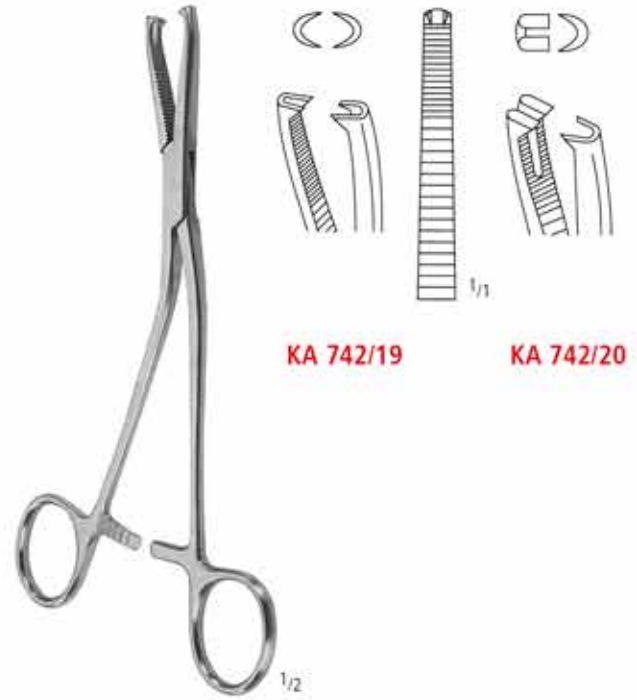

DINGMANN
 19,0 cm/7½"



MARTIN
 KA 744/19
 19,0 cm/7½"



KA 745/13
 13,5 cm/5¼"

Knochenhaltezangen
 Bone Holding Forceps
 Pinzas para huesos
 Daviers porte-os
 Tenaglie per ossa



KA 747/21
 21,0 cm/8¹/₄"



LEWIN
KA 750/17
 17,5 cm/7"

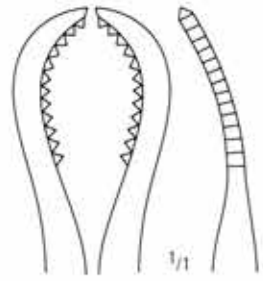

KA 752/16
 16,0 cm/6¹/₄"

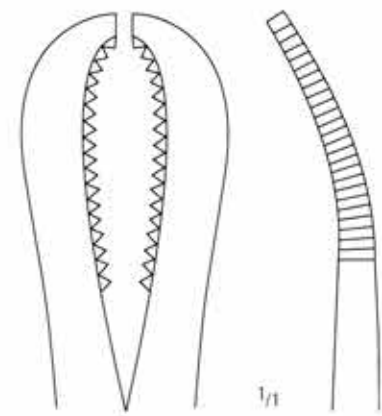

KA 752/24
 24,0 cm/9¹/₂"

Knochenhalte­zangen
 Bone Holding Forceps
 Pinzas para huesos
 Daviers porte-os
 Tenaglie per ossa

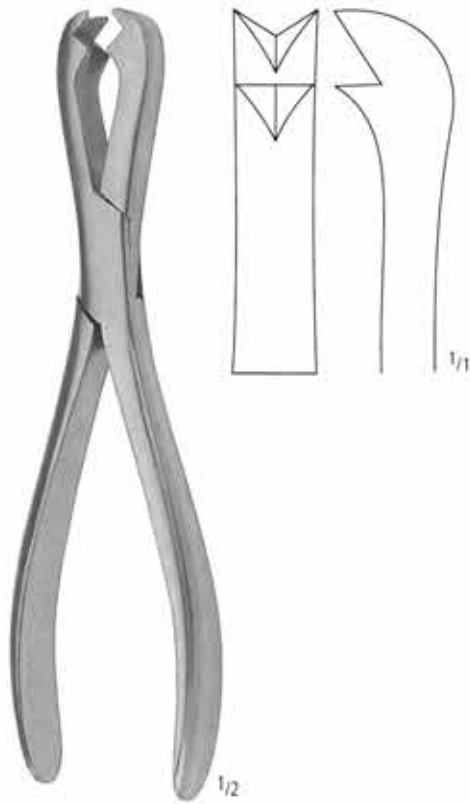

FERGUSSON
KA 754/21
 21,0 cm/8¹/₄"



LANGENBECK
KA 756/21
 21,0 cm/8¹/₄"



KA 757/20
 20,0 cm/8"

AA
 AB
 AC
 AD
 AE
 AF
 AG
 AH
 AI
 AJ
 AK
 AL
 AM
 AN
 AO
 AP
 AQ
 AR
 AS
 AT
 AU
 AV
 AW
 AX
 AY
 AZ

KA

KD

KU

KV

Knochenhaltezangen
 Bone Holding Forceps
 Pinzas para huesos
 Daviers porte-os
 Tenaglie per ossa



KA 758/17
 17,0 cm/6³/₄"

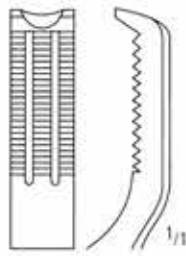

KA 758/21
 21,0 cm/8¹/₂"

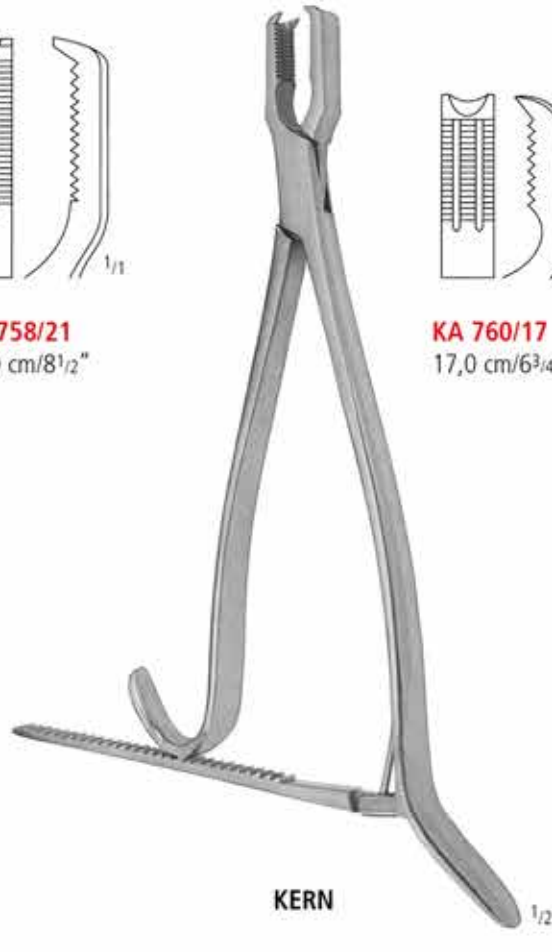

KA 760/17
 17,0 cm/6³/₄"

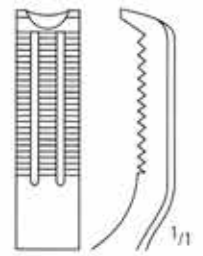

KA 760/21
 21,0 cm/8¹/₂"

KERN

KERN



SEMB
KA 762/19
 19,0 cm/7¹/₂"

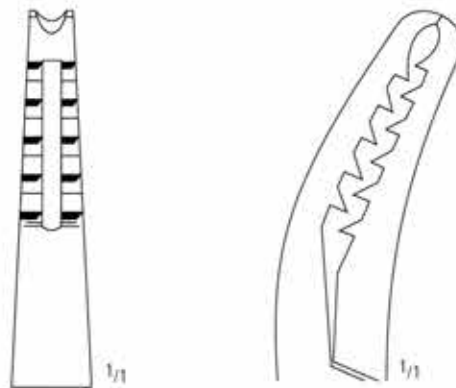

SEMB
KA 763/19
 19,0 cm/7¹/₂"

Knochenhalte­zangen
Bone Holding Forceps
Pinzas para huesos
Daviers porte-os
Tenaglie per ossa



LANE

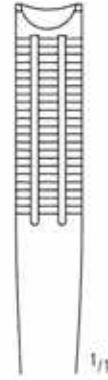

KA 766/33
33,0 cm/13"

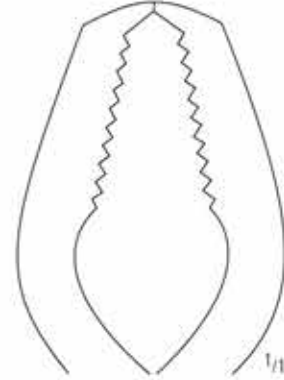

mit Sperre
with ratchet
con cremallera
avec crémaillère
con cremagliera

KA 768/33
33,0 cm/13"

ohne Sperre
without ratchet
sin cremallera
sans crémaillère
senza cremagliera

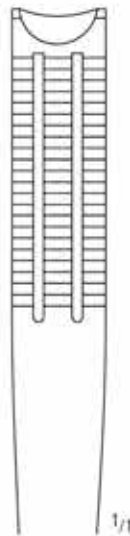

KA 768/45
45,0 cm/17³/₄"

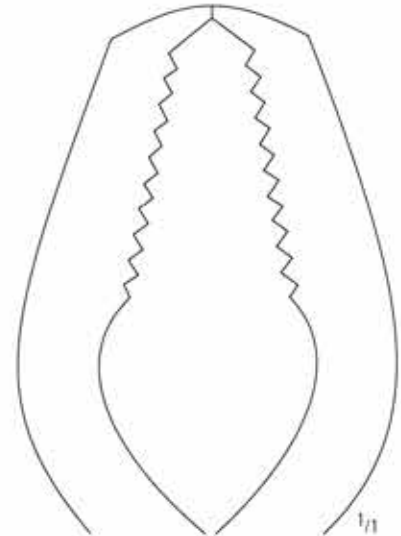

ohne Sperre
without ratchet
sin cremallera
sans crémaillère
senza cremagliera

AA
AB
AC
AD
AE
AF
AK
AL
AM
AO
AP
AR
KA
KD
KU
KY

Knochenhalte­zangen
 Bone Holding Forceps
 Pinzas para huesos
 Daviers porte-os
 Tenaglie per ossa



FARABEUF-LAMBOTTE
KA 769/26
 26,0 cm/10¹/₄"



KA 770/23
 23,0 cm/9"

KA 770/26
 26,0 cm/10¹/₄"

FARABEUF

Knochenhalte­zangen
 Bone Holding Forceps
 Pinzas para huesos
 Daviers porte-os
 Tenaglie per ossa



VERBRUGGE

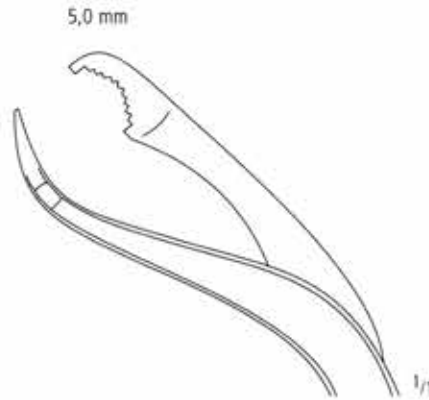

KA 771/05
 17,5 cm/6³/₄"

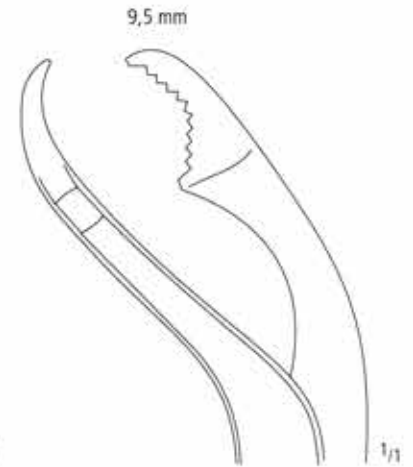

KA 771/10
 25,0 cm/10"



KA 771/11
 26,0 cm/10¹/₄"

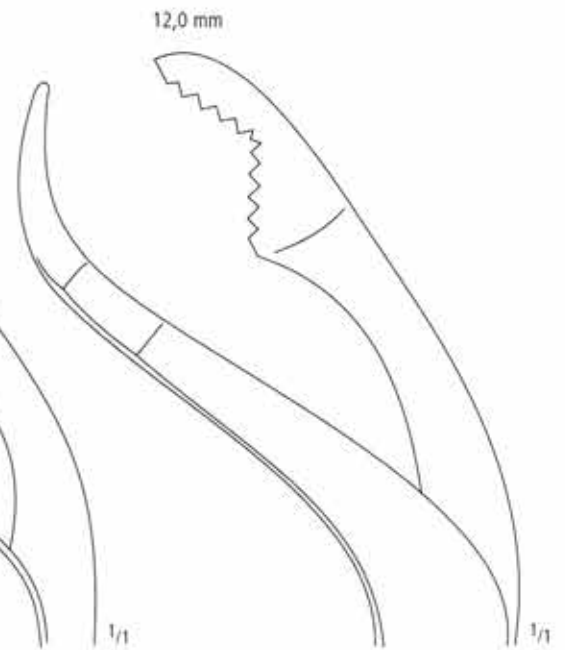

KA 771/12
 27,0 cm/11"

AA
 AB
 AC
 AD
 AE
 AF
 AG
 AH
 AI
 AJ
 AK
 AL
 AM
 AN
 AO
 AP
 AQ
 AR
 AS
 AT
 AU
 AV
 AW
 AX
 AY
 AZ
 BA
 BB
 BC
 BD
 BE
 BF
 BG
 BH
 BI
 BJ
 BK
 BL
 BM
 BN
 BO
 BP
 BQ
 BR
 BS
 BT
 BU
 BV
 BW
 BX
 BY
 BZ
 CA
 CB
 CC
 CD
 CE
 CF
 CG
 CH
 CI
 CJ
 CK
 CL
 CM
 CN
 CO
 CP
 CQ
 CR
 CS
 CT
 CU
 CV
 CW
 CX
 CY
 CZ
 DA
 DB
 DC
 DD
 DE
 DF
 DG
 DH
 DI
 DJ
 DK
 DL
 DM
 DN
 DO
 DP
 DQ
 DR
 DS
 DT
 DU
 DV
 DW
 DX
 DY
 DZ
 EA
 EB
 EC
 ED
 EE
 EF
 EG
 EH
 EI
 EJ
 EK
 EL
 EM
 EN
 EO
 EP
 EQ
 ER
 ES
 ET
 EU
 EV
 EW
 EX
 EY
 EZ
 FA
 FB
 FC
 FD
 FE
 FF
 FG
 FH
 FI
 FJ
 FK
 FL
 FM
 FN
 FO
 FP
 FQ
 FR
 FS
 FT
 FU
 FV
 FW
 FX
 FY
 FZ
 GA
 GB
 GC
 GD
 GE
 GF
 GG
 GH
 GI
 GJ
 GK
 GL
 GM
 GN
 GO
 GP
 GQ
 GR
 GS
 GT
 GU
 GV
 GW
 GX
 GY
 GZ
 HA
 HB
 HC
 HD
 HE
 HF
 HG
 HH
 HI
 HJ
 HK
 HL
 HM
 HN
 HO
 HP
 HQ
 HR
 HS
 HT
 HU
 HV
 HW
 HX
 HY
 HZ
 IA
 IB
 IC
 ID
 IE
 IF
 IG
 IH
 II
 IJ
 IK
 IL
 IM
 IN
 IO
 IP
 IQ
 IR
 IS
 IT
 IU
 IV
 IW
 IX
 IY
 IZ
 JA
 JB
 JC
 JD
 JE
 JF
 JG
 JH
 JI
 JJ
 JK
 JL
 JM
 JN
 JO
 JP
 JQ
 JR
 JS
 JT
 JU
 JV
 JW
 JX
 JY
 JZ
 KA
 KB
 KC
 KD
 KE
 KF
 KG
 KH
 KI
 KJ
 KK
 KL
 KM
 KN
 KO
 KP
 KQ
 KR
 KS
 KT
 KU
 KV
 KW
 KX
 KY
 KZ
 LA
 LB
 LC
 LD
 LE
 LF
 LG
 LH
 LI
 LJ
 LK
 LL
 LM
 LN
 LO
 LP
 LQ
 LR
 LS
 LT
 LU
 LV
 LW
 LX
 LY
 LZ
 MA
 MB
 MC
 MD
 ME
 MF
 MG
 MH
 MI
 MJ
 MK
 ML
 MM
 MN
 MO
 MP
 MQ
 MR
 MS
 MT
 MU
 MV
 MW
 MX
 MY
 MZ
 NA
 NB
 NC
 ND
 NE
 NF
 NG
 NH
 NI
 NJ
 NK
 NL
 NM
 NN
 NO
 NP
 NQ
 NR
 NS
 NT
 NU
 NV
 NW
 NX
 NY
 NZ
 OA
 OB
 OC
 OD
 OE
 OF
 OG
 OH
 OI
 OJ
 OK
 OL
 OM
 ON
 OO
 OP
 OQ
 OR
 OS
 OT
 OU
 OV
 OW
 OX
 OY
 OZ
 PA
 PB
 PC
 PD
 PE
 PF
 PG
 PH
 PI
 PJ
 PK
 PL
 PM
 PN
 PO
 PP
 PQ
 PR
 PS
 PT
 PU
 PV
 PW
 PX
 PY
 PZ
 QA
 QB
 QC
 QD
 QE
 QF
 QG
 QH
 QI
 QJ
 QK
 QL
 QM
 QN
 QO
 QP
 QQ
 QR
 QS
 QT
 QU
 QV
 QW
 QX
 QY
 QZ
 RA
 RB
 RC
 RD
 RE
 RF
 RG
 RH
 RI
 RJ
 RK
 RL
 RM
 RN
 RO
 RP
 RQ
 RR
 RS
 RT
 RU
 RV
 RW
 RX
 RY
 RZ
 SA
 SB
 SC
 SD
 SE
 SF
 SG
 SH
 SI
 SJ
 SK
 SL
 SM
 SN
 SO
 SP
 SQ
 SR
 SS
 ST
 SU
 SV
 SW
 SX
 SY
 SZ
 TA
 TB
 TC
 TD
 TE
 TF
 TG
 TH
 TI
 TJ
 TK
 TL
 TM
 TN
 TO
 TP
 TQ
 TR
 TS
 TT
 TU
 TV
 TW
 TX
 TY
 TZ
 UA
 UB
 UC
 UD
 UE
 UF
 UG
 UH
 UI
 UJ
 UK
 UL
 UM
 UN
 UO
 UP
 UQ
 UR
 US
 UT
 UU
 UV
 UW
 UX
 UY
 UZ
 VA
 VB
 VC
 VD
 VE
 VF
 VG
 VH
 VI
 VJ
 VK
 VL
 VM
 VN
 VO
 VP
 VQ
 VR
 VS
 VT
 VU
 VV
 VW
 VX
 VY
 VZ
 WA
 WB
 WC
 WD
 WE
 WF
 WG
 WH
 WI
 WJ
 WK
 WL
 WM
 WN
 WO
 WP
 WQ
 WR
 WS
 WT
 WU
 WV
 WW
 WX
 WY
 WZ
 XA
 XB
 XC
 XD
 XE
 XF
 XG
 XH
 XI
 XJ
 XK
 XL
 XM
 XN
 XO
 XP
 XQ
 XR
 XS
 XT
 XU
 XV
 XW
 XX
 XY
 XZ
 YA
 YB
 YC
 YD
 YE
 YF
 YG
 YH
 YI
 YJ
 YK
 YL
 YM
 YN
 YO
 YP
 YQ
 YR
 YS
 YT
 YU
 YV
 YW
 YX
 YZ
 ZA
 ZB
 ZC
 ZD
 ZE
 ZF
 ZG
 ZH
 ZI
 ZJ
 ZK
 ZL
 ZM
 ZN
 ZO
 ZP
 ZQ
 ZR
 ZS
 ZT
 ZU
 ZV
 ZW
 ZX
 ZY
 ZZ

Knochenhaltezangen
 Bone Holding Forceps
 Pinzas para huesos
 Daviers porte-os
 Tenaglie per ossa

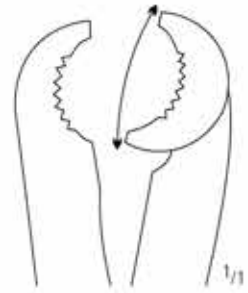
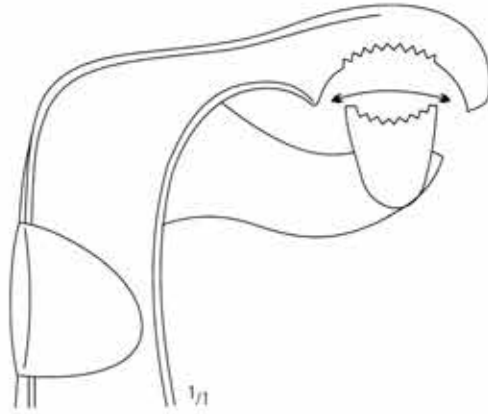

LAMBOTTE

- KA 772/22 - 22,0 cm/8³/₄"
- KA 772/26 - 26,0 cm/10¹/₄"
- KA 772/33 - 33,0 cm/13"

LAMBOTTE

- KA 773/19 - 19,0 cm/7¹/₂"
- KA 773/23 - 23,0 cm/9"
- KA 773/26 - 26,0 cm/10¹/₄"

LAMBOTTE

- KA 774/22 - 22,0 cm/8³/₄"
- KA 774/27 - 27,0 cm/10¹/₂"
- KA 774/30 - 30,0 cm/12"

Knochenhalte­zangen
 Bone Holding Forceps
 Pinzas para huesos
 Daviers porte-os
 Tenaglie per ossa

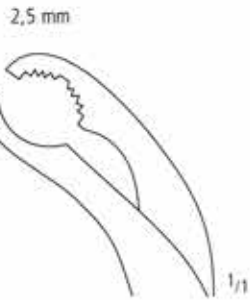
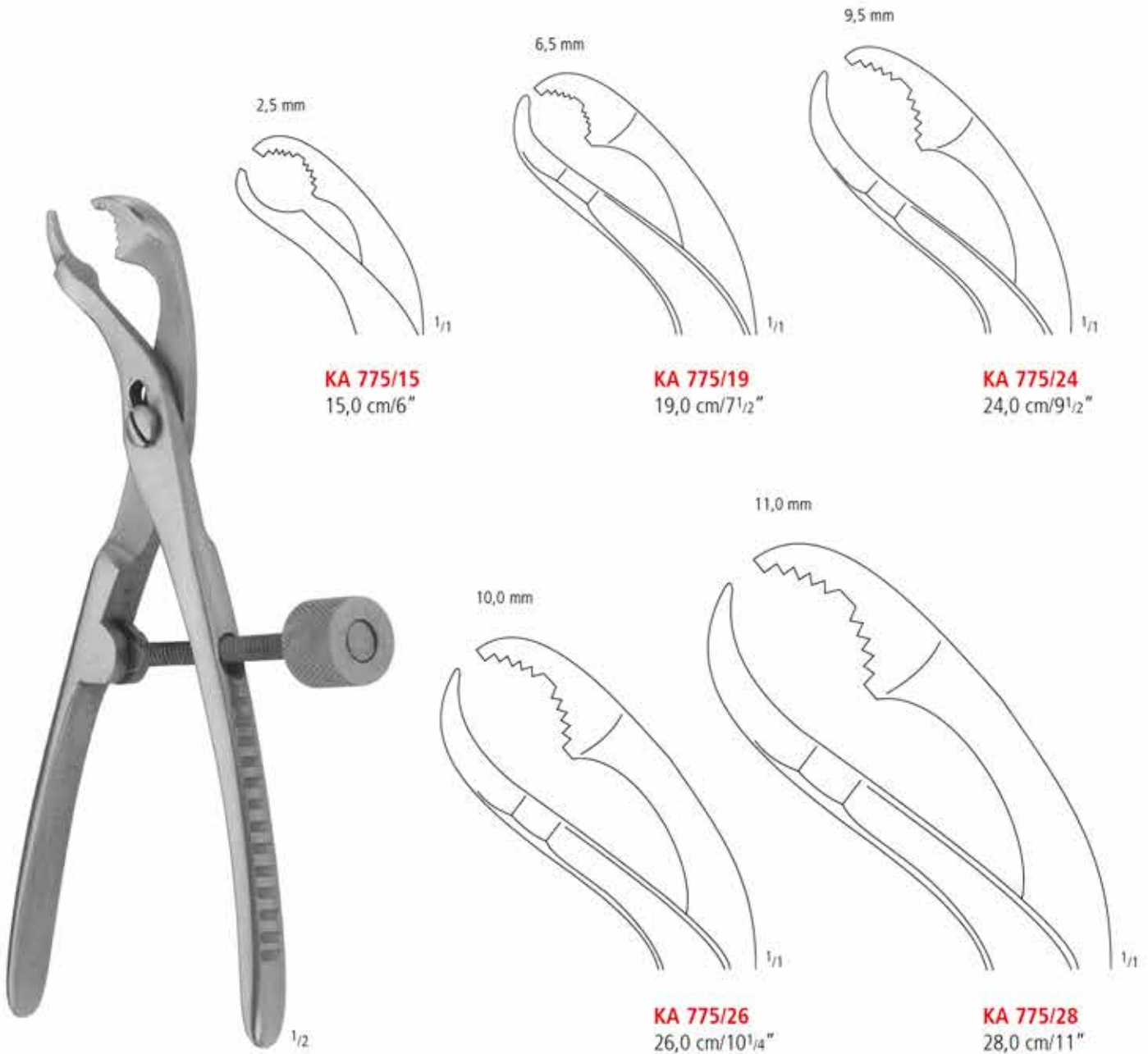

KA 775/15
 15,0 cm/6"

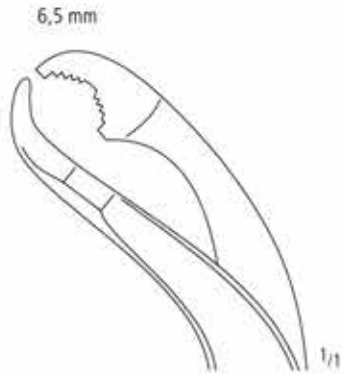

KA 775/19
 19,0 cm/7 1/2"

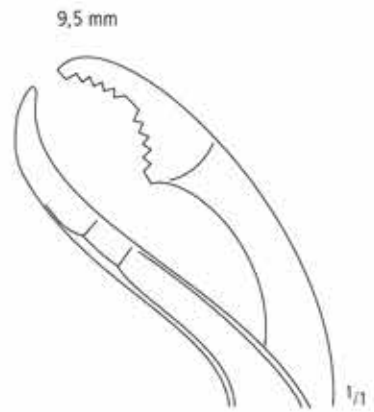

KA 775/24
 24,0 cm/9 1/2"

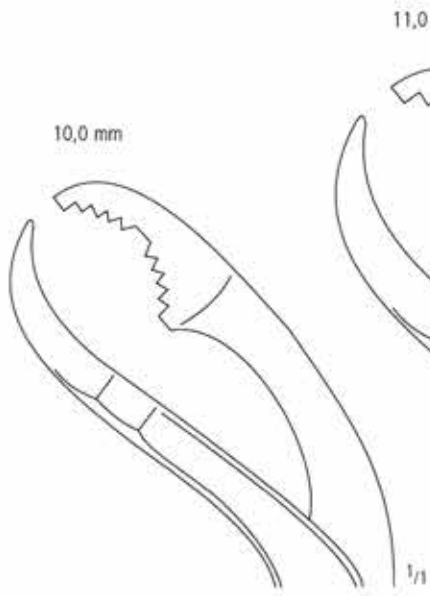

KA 775/26
 26,0 cm/10 1/4"

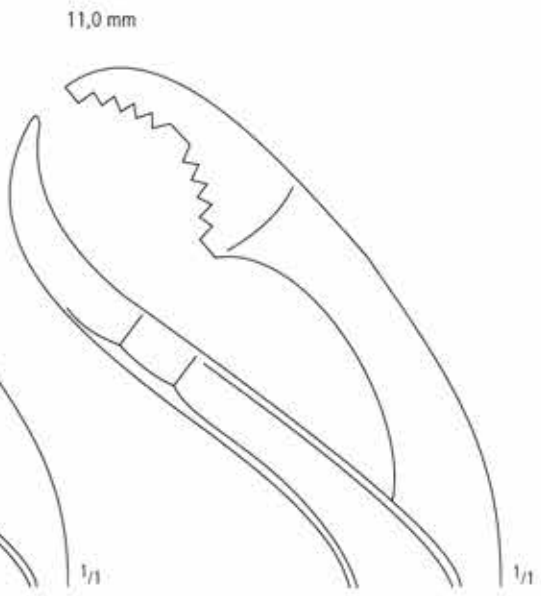

KA 775/28
 28,0 cm/11"

AA
 AB
 AC
 AD
 AE
 AF
 AK
 AL
 AM
 AO
 AP
 AR
KA
 KD
 KU
 KY

Knochenhalte­zangen
 Bone Holding Forceps
 Pinzas para huesos
 Daviers porte-os
 Tenaglie per ossa



KA 777/23
 23,0 cm/9"



KA 778/23
 23,0 cm/9"

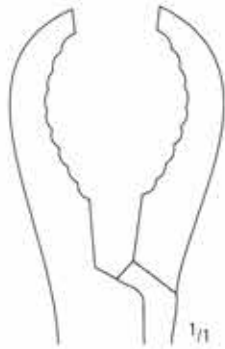

KA 777/25
 25,0 cm/10"

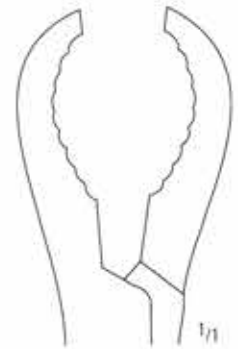

KA 778/25
 25,0 cm/10"

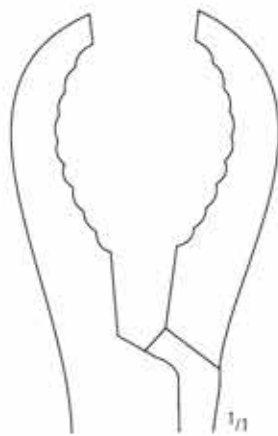

KA 777/28
 28,0 cm/11"

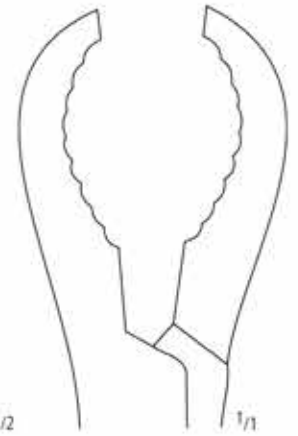

KA 778/28
 28,0 cm/11"



ULRICH



ULRICH

Amputationsschild
Amputation Shield
Retractor para amputación
Retracteur pour amputation
Retratore per amputazione



PERCY
KA 780/00

AA

AB

AC

AD

AE

AF

AK

AL

AM

AO

AP

AR

KA

KD

KU

KY

Sehnenfassinstrumente
Tendon Seizing Instruments
Instrumentos para coger tendones
Instruments pour saisir les tendons
Strumenti per afferrare tendini



KA 785/15
15,0 cm/6"

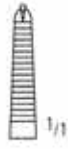

KA 785/19
19,0 cm/7 1/2"

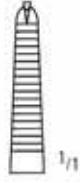

KA 785/24
24,0 cm/9 1/2"



CAROLL
KA 786/11
11,0 cm/4"



STEINMANN
KA 787/16
16,0 cm/6 1/4"



KLEINERT-KUTZ
KA 788/20
20,0 cm/8"

Sehnenstripper
Tendon Stripper
Separadores para tendones
Instruments à écorcher les tendons
Scollatendini



biegsam
malleable
maleable
malléable
malleabile

BUNNELL
KA 790/23
23,0 cm/9"



4,0 mm
KA 791/40

4,5 mm
KA 791/45

5,5 mm
KA 791/55

23,0 cm/9"
biegsam
malleable
maleable
malléable
malleabile



4,0 mm
KA 792/01

4,5 mm
KA 792/02

5,5 mm
KA 792/03

KA 792/04

KA 792/05

BUNNELL
15,0 cm/6"

AA
AB
AC
AD
AE
AF
AK
AL
AM
AO
AP
AR
KA
KD
KU
KY

Wund- und Meniskushaken
 Knee Retractors
 Separadores para rodilla
 Ecarteurs pour le genou
 Divaricatori per il ginocchio

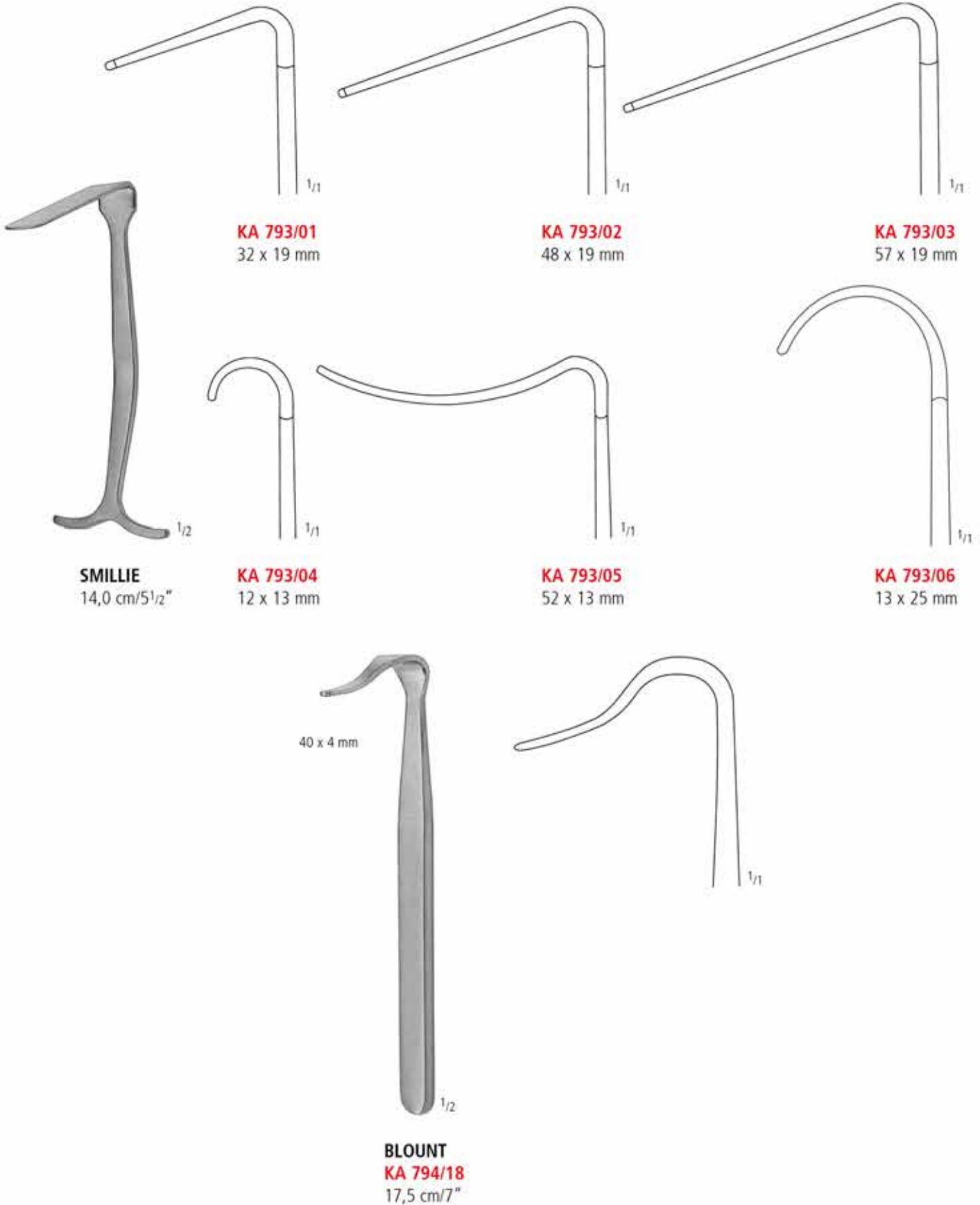

Meniskotome
Meniscotomy Knives
Bisturios para meniscos
Bistouris à ménisques
Meniscotomi

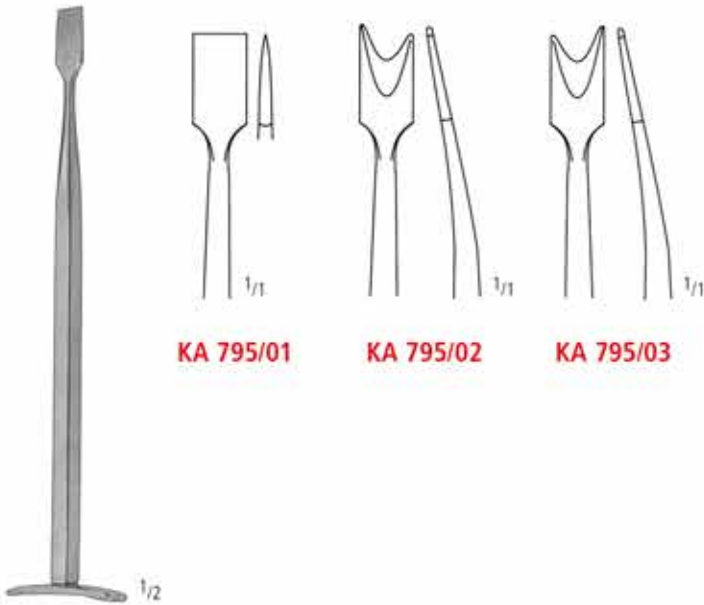

KA 795/01

KA 795/02

KA 795/03

SMILLIE
17,0 cm/6³/₄"



SALENIUS
KA 796/01
22,0 cm/8³/₄"

SALENIUS
KA 796/02
22,0 cm/8³/₄"

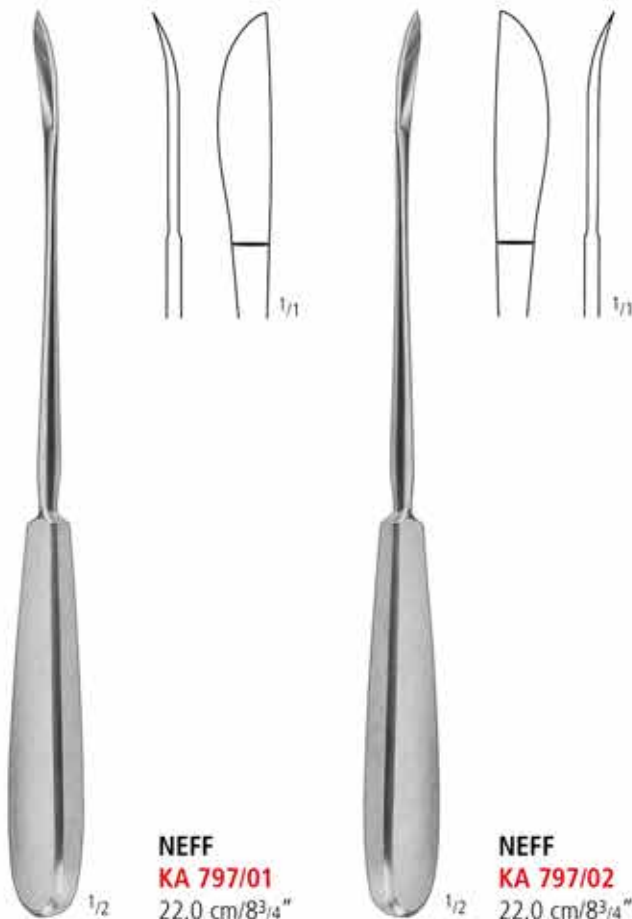

NEFF
KA 797/01
22,0 cm/8³/₄"

NEFF
KA 797/02
22,0 cm/8³/₄"

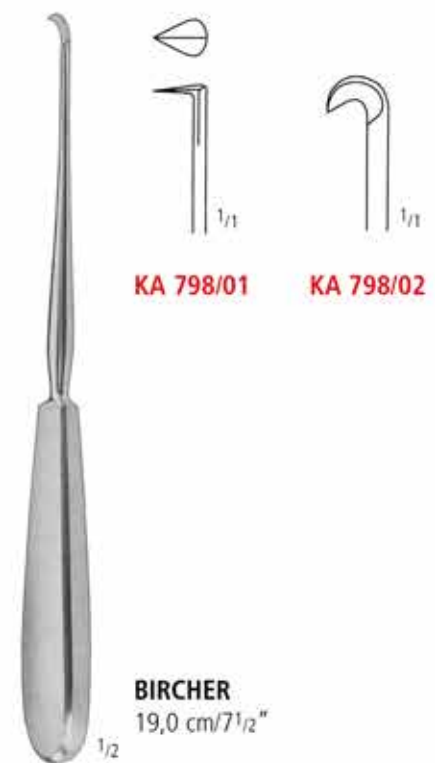

KA 798/01

KA 798/02

BIRCHER
19,0 cm/7¹/₂"

AA
AB
AC
AD
AE
AF
AK
AL
AM
AO
AP
AR
KA
KD
KU
KY

Hohlmeisselzangen
 Bone Rongeurs
 Pinzas-gubias
 Pincès-gouges
 Pinze-sgorbie

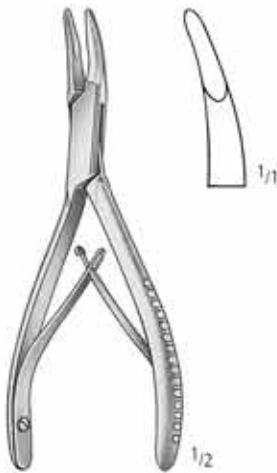

MINI-FRIEDMAN
KA 800/12
 12,0 cm/5"

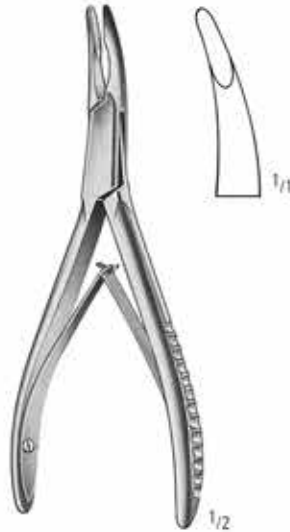

FRIEDMAN
KA 800/14
 14,0 cm/5 1/2"

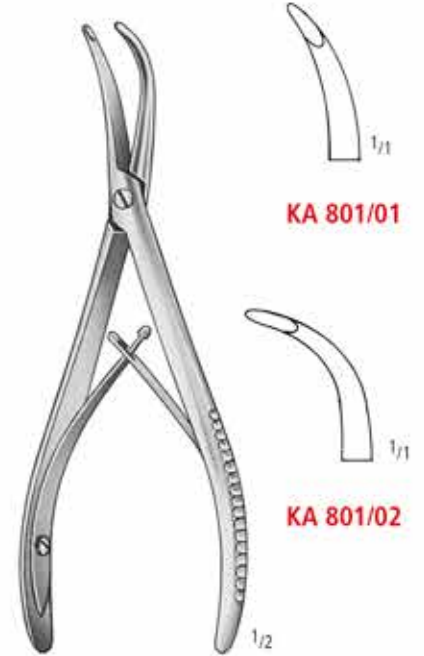

KA 801/01

KA 801/02

STELLBRINK
 17,0 cm/6 3/4"

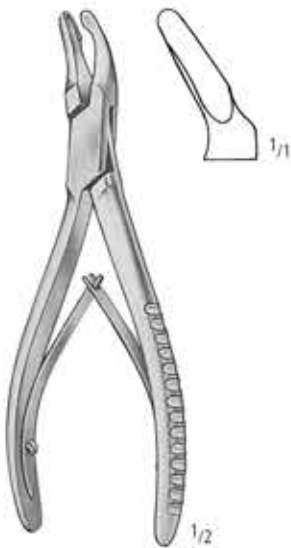

CLEVELAND
KA 802/14
 14,0 cm/5 1/2"

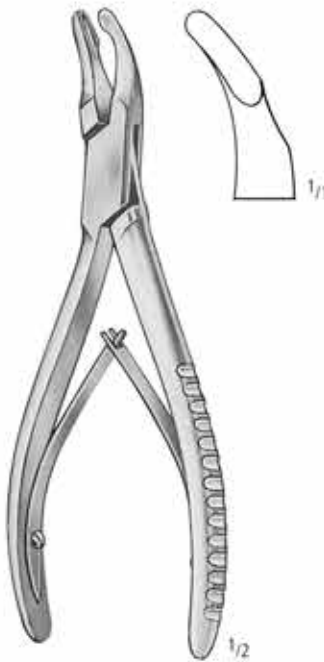

CLEVELAND
KA 802/17
 17,0 cm/6 3/4"

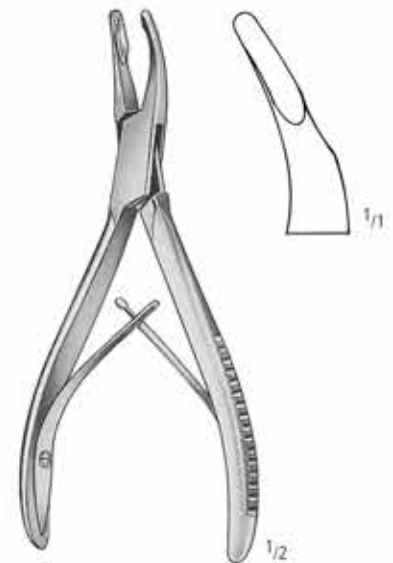

UNIVERSAL
KA 803/13
 13,5 cm/5 1/4"

ORTHOPÄDIE ORTHOPAEDIC ORTOPEDIA ORTHOPEDIE ORTOPEDIA

Hohlmeisselzangen
 Bone Rongeurs
 Pinzas-gubias
 Pincès-gouges
 Pinze-sgorbie

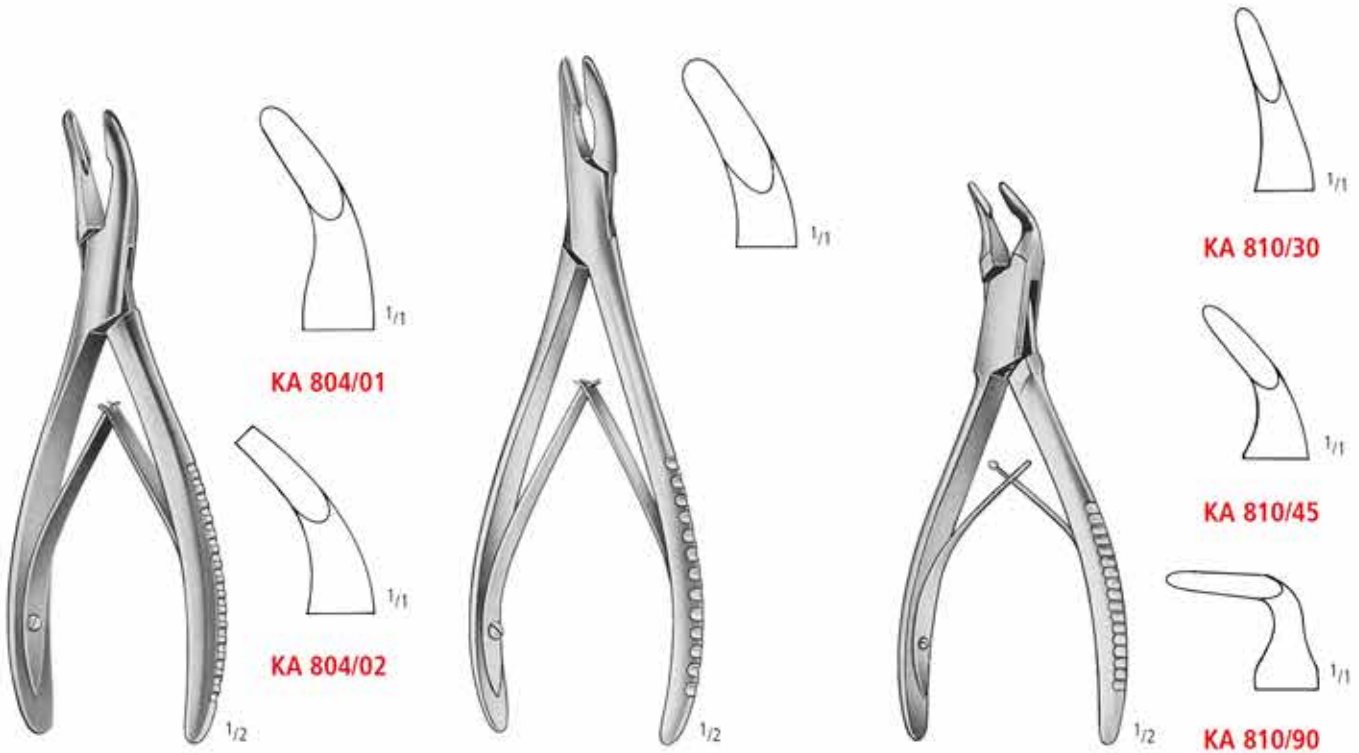

MEAD
 16,5 cm/6¹/₂"

HARTMANN
KA 807/18
 18,5 cm/7¹/₃"

BLUMENTHAL
 15,5 cm/6"

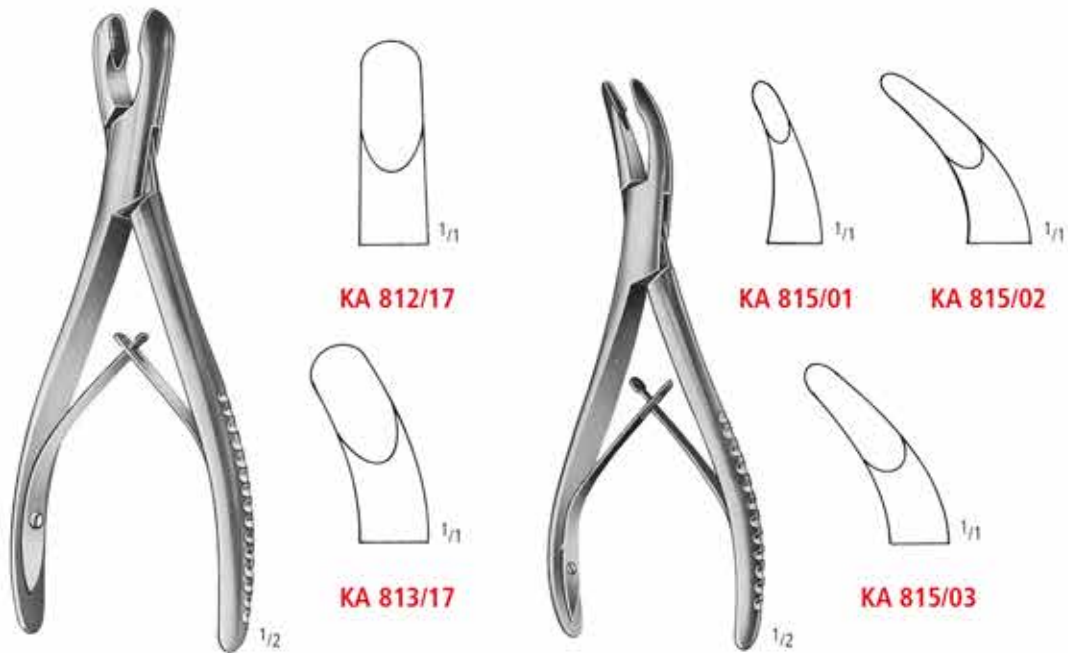

LUER
 17,0 cm/6³/₄"

LUER
 15,0 cm/6"

AA
 AB
 AC
 AD
 AE
 AF
 AG
 AH
 AI
 AJ
 AK
 AL
 AM
 AN
 AO
 AP
 AQ
 AR
 AS
 AT
 AU
 AV
 AW
 AX
 AY
 AZ

KA

Hohlmeisselzangen
 Bone Rongeurs
 Pinzas-gubias
 Pincés-gouges
 Pinze-sgorbie



LEMPERT
KA 816/19
 19,0 cm/7¹/₂"



BACON
KA 819/20
 20,0 cm/8"



MARQUARDT
KA 821/20
 20,0 cm/8"



MAYFIELD
KA 823/17
 17,0 cm/6³/₄"

Hohlmeisselzangen
 Bone Rongeurs
 Pinzas-gubias
 Pincas-gouges
 Pinze-sgorbie



KA 825/01



KA 825/02



KA 825/03

BÖHLER
 15,0 cm/6"



KA 827/02

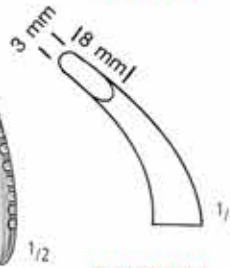

KA 827/03

KLEINERT-KUTZ
 15,0 cm/6"



RUSKIN-MINI
KA 829/15
 15,0 cm/6"



BEYER
KA 830/18
 18,0 cm/7"



ZAUFAL-JANSEN
KA 835/18
 18,0 cm/7"

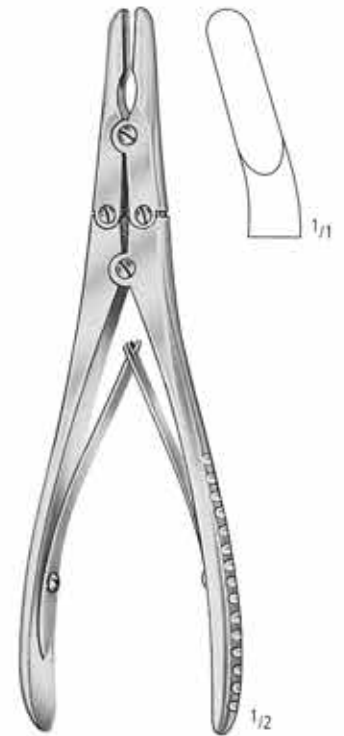

RUSKIN
KA 836/18
 18,0 cm/7"

AA
 AB
 AC
 AD
 AE
 AF
 AG
 AH
 AI
 AJ
 AK
 AL
 AM
 AN
 AO
 AP
 AR
 AS
 AT
 AU
 AV
 AW
 AX
 AY
 AZ
 BA
 BB
 BC
 BD
 BE
 BF
 BG
 BH
 BI
 BJ
 BK
 BL
 BM
 BN
 BO
 BP
 BQ
 BR
 BS
 BT
 BU
 BV
 BW
 BX
 BY
 BZ
 CA
 CB
 CC
 CD
 CE
 CF
 CG
 CH
 CI
 CJ
 CK
 CL
 CM
 CN
 CO
 CP
 CQ
 CR
 CS
 CT
 CU
 CV
 CW
 CX
 CY
 CZ
 DA
 DB
 DC
 DD
 DE
 DF
 DG
 DH
 DI
 DJ
 DK
 DL
 DM
 DN
 DO
 DP
 DQ
 DR
 DS
 DT
 DU
 DV
 DW
 DX
 DY
 DZ
 EA
 EB
 EC
 ED
 EE
 EF
 EG
 EH
 EI
 EJ
 EK
 EL
 EM
 EN
 EO
 EP
 EQ
 ER
 ES
 ET
 EU
 EV
 EW
 EX
 EY
 EZ
 FA
 FB
 FC
 FD
 FE
 FF
 FG
 FH
 FI
 FJ
 FK
 FL
 FM
 FN
 FO
 FP
 FQ
 FR
 FS
 FT
 FU
 FV
 FW
 FX
 FY
 FZ
 GA
 GB
 GC
 GD
 GE
 GF
 GG
 GH
 GI
 GJ
 GK
 GL
 GM
 GN
 GO
 GP
 GQ
 GR
 GS
 GT
 GU
 GV
 GW
 GX
 GY
 GZ
 HA
 HB
 HC
 HD
 HE
 HF
 HG
 HH
 HI
 HJ
 HK
 HL
 HM
 HN
 HO
 HP
 HQ
 HR
 HS
 HT
 HU
 HV
 HW
 HX
 HY
 HZ
 IA
 IB
 IC
 ID
 IE
 IF
 IG
 IH
 II
 IJ
 IK
 IL
 IM
 IN
 IO
 IP
 IQ
 IR
 IS
 IT
 IU
 IV
 IU
 IV
 IU
 IV

KA

KD
 KE
 KF
 KG
 KH
 KI
 KJ
 KK
 KL
 KM
 KN
 KO
 KP
 KQ
 KR
 KS
 KT
 KU
 KV
 KW
 KX
 KY
 KZ

Hohlmeisselzangen
 Bone Rongeurs
 Pinzas-gubias
 Pincis-gouges
 Pinze-sgorbie

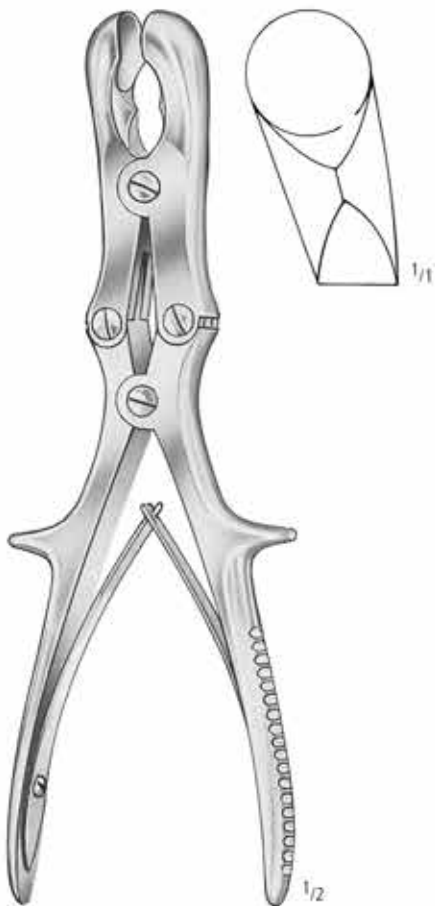

SEMB
KA 838/22
 22,5 cm/9"

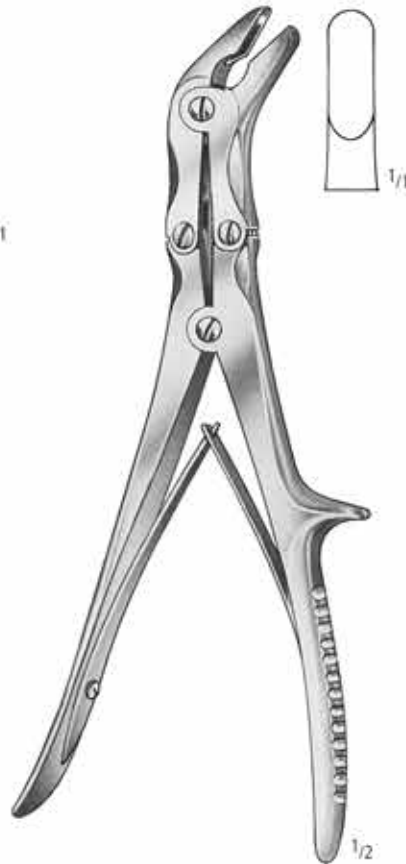

STILLE
KA 840/23
 23,0 cm/9"



STILLE-RUSKIN
KA 841/23
 23,0 cm/9"

Hohlmeisselzangen
 Bone Rongeurs
 Pinzas-gubias
 Pincis-gouges
 Pinze-sgorbie



ROETTGEN-RUSKIN
KA 845/24
 24,0 cm/9¹/₂"



LEKSELL-STILLE
 24,0 cm/9¹/₂"



KA 848/01
 8 mm

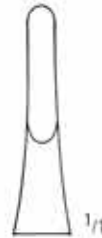

KA 848/02
 4 mm



STILLE-LUER
 22,0 cm/8³/₄"

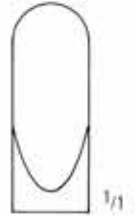

KA 852/22



KA 853/22

AA
 AB
 AC
 AD
 AE
 AF
 AG
 AH
 AI
 AJ
 AK
 AL
 AM
 AN
 AO
 AP
 AQ
 AR
 AS
 AT
 AU
 AV
 AW
 AX
 AY
 AZ
 BA
 BB
 BC
 BD
 BE
 BF
 BG
 BH
 BI
 BJ
 BK
 BL
 BM
 BN
 BO
 BP
 BQ
 BR
 BS
 BT
 BU
 BV
 BW
 BX
 BY
 BZ
 CA
 CB
 CC
 CD
 CE
 CF
 CG
 CH
 CI
 CJ
 CK
 CL
 CM
 CN
 CO
 CP
 CQ
 CR
 CS
 CT
 CU
 CV
 CW
 CX
 CY
 CZ
 DA
 DB
 DC
 DD
 DE
 DF
 DG
 DH
 DI
 DJ
 DK
 DL
 DM
 DN
 DO
 DP
 DQ
 DR
 DS
 DT
 DU
 DV
 DW
 DX
 DY
 DZ
 EA
 EB
 EC
 ED
 EE
 EF
 EG
 EH
 EI
 EJ
 EK
 EL
 EM
 EN
 EO
 EP
 EQ
 ER
 ES
 ET
 EU
 EV
 EW
 EX
 EY
 EZ
 FA
 FB
 FC
 FD
 FE
 FF
 FG
 FH
 FI
 FJ
 FK
 FL
 FM
 FN
 FO
 FP
 FQ
 FR
 FS
 FT
 FU
 FV
 FW
 FX
 FY
 FZ
 GA
 GB
 GC
 GD
 GE
 GF
 GG
 GH
 GI
 GJ
 GK
 GL
 GM
 GN
 GO
 GP
 GQ
 GR
 GS
 GT
 GU
 GV
 GW
 GX
 GY
 GZ
 HA
 HB
 HC
 HD
 HE
 HF
 HG
 HH
 HI
 HJ
 HK
 HL
 HM
 HN
 HO
 HP
 HQ
 HR
 HS
 HT
 HU
 HV
 HW
 HX
 HY
 HZ
 IA
 IB
 IC
 ID
 IE
 IF
 IG
 IH
 II
 IJ
 IK
 IL
 IM
 IN
 IO
 IP
 IQ
 IR
 IS
 IT
 IU
 IV
 IW
 IX
 IY
 IZ
 JA
 JB
 JC
 JD
 JE
 JF
 JG
 JH
 JI
 JJ
 JK
 JL
 JM
 JN
 JO
 JP
 JQ
 JR
 JS
 JT
 JU
 JV
 JW
 JX
 JY
 JZ
 KA
 KB
 KC
 KD
 KE
 KF
 KG
 KH
 KI
 KJ
 KK
 KL
 KM
 KN
 KO
 KP
 KQ
 KR
 KS
 KT
 KU
 KV
 KW
 KX
 KY
 KZ
 LA
 LB
 LC
 LD
 LE
 LF
 LG
 LH
 LI
 LJ
 LK
 LL
 LM
 LN
 LO
 LP
 LQ
 LR
 LS
 LT
 LU
 LV
 LW
 LX
 LY
 LZ
 MA
 MB
 MC
 MD
 ME
 MF
 MG
 MH
 MI
 MJ
 MK
 ML
 MM
 MN
 MO
 MP
 MQ
 MR
 MS
 MT
 MU
 MV
 MW
 MX
 MY
 MZ
 NA
 NB
 NC
 ND
 NE
 NF
 NG
 NH
 NI
 NJ
 NK
 NL
 NM
 NN
 NO
 NP
 NQ
 NR
 NS
 NT
 NU
 NV
 NW
 NX
 NY
 NZ
 OA
 OB
 OC
 OD
 OE
 OF
 OG
 OH
 OI
 OJ
 OK
 OL
 OM
 ON
 OO
 OP
 OQ
 OR
 OS
 OT
 OU
 OV
 OW
 OX
 OY
 OZ
 PA
 PB
 PC
 PD
 PE
 PF
 PG
 PH
 PI
 PJ
 PK
 PL
 PM
 PN
 PO
 PP
 PQ
 PR
 PS
 PT
 PU
 PV
 PW
 PX
 PY
 PZ
 QA
 QB
 QC
 QD
 QE
 QF
 QG
 QH
 QI
 QJ
 QK
 QL
 QM
 QN
 QO
 QP
 QQ
 QR
 QS
 QT
 QU
 QV
 QW
 QX
 QY
 QZ
 RA
 RB
 RC
 RD
 RE
 RF
 RG
 RH
 RI
 RJ
 RK
 RL
 RM
 RN
 RO
 RP
 RQ
 RR
 RS
 RT
 RU
 RV
 RW
 RX
 RY
 RZ
 SA
 SB
 SC
 SD
 SE
 SF
 SG
 SH
 SI
 SJ
 SK
 SL
 SM
 SN
 SO
 SP
 SQ
 SR
 SS
 ST
 SU
 SV
 SW
 SX
 SY
 SZ
 TA
 TB
 TC
 TD
 TE
 TF
 TG
 TH
 TI
 TJ
 TK
 TL
 TM
 TN
 TO
 TP
 TQ
 TR
 TS
 TT
 TU
 TV
 TW
 TX
 TY
 TZ
 UA
 UB
 UC
 UD
 UE
 UF
 UG
 UH
 UI
 UJ
 UK
 UL
 UM
 UN
 UO
 UP
 UQ
 UR
 US
 UT
 UY
 UZ
 VA
 VB
 VC
 VD
 VE
 VF
 VG
 VH
 VI
 VJ
 VK
 VL
 VM
 VN
 VO
 VP
 VQ
 VR
 VS
 VT
 VU
 VV
 VW
 VX
 VY
 VZ
 WA
 WB
 WC
 WD
 WE
 WF
 WG
 WH
 WI
 WJ
 WK
 WL
 WM
 WN
 WO
 WP
 WQ
 WR
 WS
 WT
 WU
 WV
 WW
 WX
 WY
 WZ
 XA
 XB
 XC
 XD
 XE
 XF
 XG
 XH
 XI
 XJ
 XK
 XL
 XM
 XN
 XO
 XP
 XQ
 XR
 XS
 XT
 XU
 XV
 XW
 XX
 XY
 XZ
 YA
 YB
 YC
 YD
 YE
 YF
 YG
 YH
 YI
 YJ
 YK
 YL
 YM
 YN
 YO
 YP
 YQ
 YR
 YS
 YT
 YU
 YV
 YW
 YX
 YZ
 ZA
 ZB
 ZC
 ZD
 ZE
 ZF
 ZG
 ZH
 ZI
 ZJ
 ZK
 ZL
 ZM
 ZN
 ZO
 ZP
 ZQ
 ZR
 ZS
 ZT
 ZU
 ZV
 ZW
 ZX
 ZY
 ZZ

Hohlmeisselzangen
 Bone Rongeurs
 Pinzas-gubias
 Pincis-gouges
 Pinze-sgorbie



SAUERBRUCH
 30,0 cm/12"



SYPERT
KA 857/36
 36,0 cm/12¹/₄"
 8 mm

Hohlmeisselzangen
 Bone Rongeurs
 Pinzas-gubias
 Pincès-gouges
 Pinze-sgorbie



FRYKHOLM
KA 859/23
 23,0 cm/9"

1/1

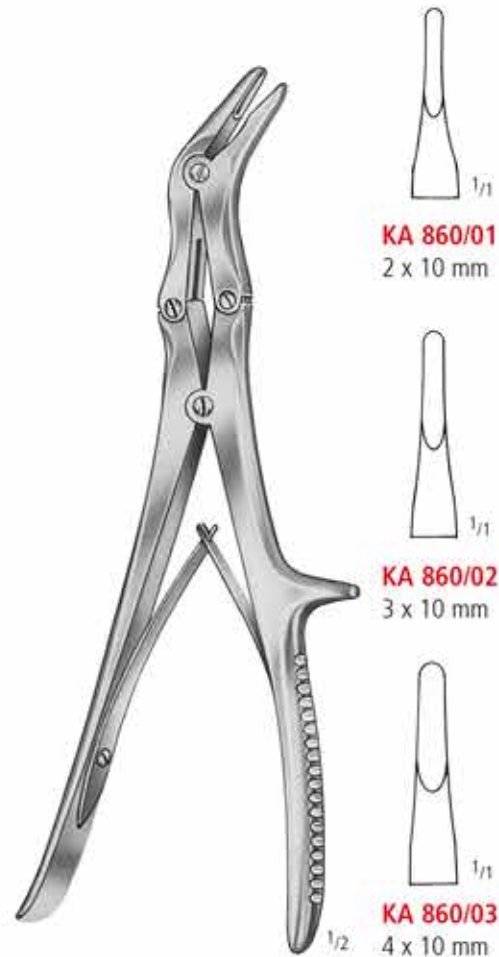

KA 860/01
 2 x 10 mm

KA 860/02
 3 x 10 mm

KA 860/03
 4 x 10 mm

ECHLIN
 23,0 cm/9"

AA
 AB
 AC
 AD
 AE
 AF
 AG
 AH
 AI
 AJ
 AK
 AL
 AM
 AN
 AO
 AP
 AQ
 AR
 AS
 AT
 AU
 AV
 AW
 AX
 AY
 AZ
 BA
 BB
 BC
 BD
 BE
 BF
 BG
 BH
 BI
 BJ
 BK
 BL
 BM
 BN
 BO
 BP
 BQ
 BR
 BS
 BT
 BU
 BV
 BW
 BX
 BY
 BZ
 CA
 CB
 CC
 CD
 CE
 CF
 CG
 CH
 CI
 CJ
 CK
 CL
 CM
 CN
 CO
 CP
 CQ
 CR
 CS
 CT
 CU
 CV
 CW
 CX
 CY
 CZ
 DA
 DB
 DC
 DD
 DE
 DF
 DG
 DH
 DI
 DJ
 DK
 DL
 DM
 DN
 DO
 DP
 DQ
 DR
 DS
 DT
 DU
 DV
 DW
 DX
 DY
 DZ
 EA
 EB
 EC
 ED
 EE
 EF
 EG
 EH
 EI
 EJ
 EK
 EL
 EM
 EN
 EO
 EP
 EQ
 ER
 ES
 ET
 EU
 EV
 EW
 EX
 EY
 EZ
 FA
 FB
 FC
 FD
 FE
 FF
 FG
 FH
 FI
 FJ
 FK
 FL
 FM
 FN
 FO
 FP
 FQ
 FR
 FS
 FT
 FU
 FV
 FW
 FX
 FY
 FZ
 GA
 GB
 GC
 GD
 GE
 GF
 GG
 GH
 GI
 GJ
 GK
 GL
 GM
 GN
 GO
 GP
 GQ
 GR
 GS
 GT
 GU
 GV
 GW
 GX
 GY
 GZ
 HA
 HB
 HC
 HD
 HE
 HF
 HG
 HH
 HI
 HJ
 HK
 HL
 HM
 HN
 HO
 HP
 HQ
 HR
 HS
 HT
 HU
 HV
 HW
 HX
 HY
 HZ
 IA
 IB
 IC
 ID
 IE
 IF
 IG
 IH
 II
 IJ
 IK
 IL
 IM
 IN
 IO
 IP
 IQ
 IR
 IS
 IT
 IU
 IV
 IW
 IX
 IY
 IZ
 JA
 JB
 JC
 JD
 JE
 JF
 JG
 JH
 JI
 JJ
 JK
 JL
 JM
 JN
 JO
 JP
 JQ
 JR
 JS
 JT
 JU
 JV
 JW
 JX
 JY
 JZ
 KA
 KB
 KC
 KD
 KE
 KF
 KG
 KH
 KI
 KJ
 KK
 KL
 KM
 KN
 KO
 KP
 KQ
 KR
 KS
 KT
 KU
 KV
 KW
 KX
 KY
 KZ
 LA
 LB
 LC
 LD
 LE
 LF
 LG
 LH
 LI
 LJ
 LK
 LL
 LM
 LN
 LO
 LP
 LQ
 LR
 LS
 LT
 LU
 LV
 LW
 LX
 LY
 LZ
 MA
 MB
 MC
 MD
 ME
 MF
 MG
 MH
 MI
 MJ
 MK
 ML
 MM
 MN
 MO
 MP
 MQ
 MR
 MS
 MT
 MU
 MV
 MW
 MX
 MY
 MZ
 NA
 NB
 NC
 ND
 NE
 NF
 NG
 NH
 NI
 NJ
 NK
 NL
 NM
 NN
 NO
 NP
 NQ
 NR
 NS
 NT
 NU
 NV
 NW
 NX
 NY
 NZ
 OA
 OB
 OC
 OD
 OE
 OF
 OG
 OH
 OI
 OJ
 OK
 OL
 OM
 ON
 OO
 OP
 OQ
 OR
 OS
 OT
 OU
 OV
 OW
 OX
 OY
 OZ
 PA
 PB
 PC
 PD
 PE
 PF
 PG
 PH
 PI
 PJ
 PK
 PL
 PM
 PN
 PO
 PP
 PQ
 PR
 PS
 PT
 PU
 PV
 PW
 PX
 PY
 PZ
 QA
 QB
 QC
 QD
 QE
 QF
 QG
 QH
 QI
 QJ
 QK
 QL
 QM
 QN
 QO
 QP
 QQ
 QR
 QS
 QT
 QU
 QV
 QW
 QX
 QY
 QZ
 RA
 RB
 RC
 RD
 RE
 RF
 RG
 RH
 RI
 RJ
 RK
 RL
 RM
 RN
 RO
 RP
 RQ
 RR
 RS
 RT
 RU
 RV
 RW
 RX
 RY
 RZ
 SA
 SB
 SC
 SD
 SE
 SF
 SG
 SH
 SI
 SJ
 SK
 SL
 SM
 SN
 SO
 SP
 SQ
 SR
 SS
 ST
 SU
 SV
 SW
 SX
 SY
 SZ
 TA
 TB
 TC
 TD
 TE
 TF
 TG
 TH
 TI
 TJ
 TK
 TL
 TM
 TN
 TO
 TP
 TQ
 TR
 TS
 TT
 TU
 TV
 TW
 TX
 TY
 TZ
 UA
 UB
 UC
 UD
 UE
 UF
 UG
 UH
 UI
 UJ
 UK
 UL
 UM
 UN
 UO
 UP
 UQ
 UR
 US
 UT
 UY
 UZ
 VA
 VB
 VC
 VD
 VE
 VF
 VG
 VH
 VI
 VJ
 VK
 VL
 VM
 VN
 VO
 VP
 VQ
 VR
 VS
 VT
 VY
 VZ
 WA
 WB
 WC
 WD
 WE
 WF
 WG
 WH
 WI
 WJ
 WK
 WL
 WM
 WN
 WO
 WP
 WQ
 WR
 WS
 WT
 WY
 WZ
 XA
 XB
 XC
 XD
 XE
 XF
 XG
 XH
 XI
 XJ
 XK
 XL
 XM
 XN
 XO
 XP
 XQ
 XR
 XS
 XT
 XY
 XZ
 YA
 YB
 YC
 YD
 YE
 YF
 YG
 YH
 YI
 YJ
 YK
 YL
 YM
 YN
 YO
 YP
 YQ
 YR
 YS
 YT
 YZ
 ZA
 ZB
 ZC
 ZD
 ZE
 ZF
 ZG
 ZH
 ZI
 ZJ
 ZK
 ZL
 ZM
 ZN
 ZO
 ZP
 ZQ
 ZR
 ZS
 ZT
 ZY
 ZZ

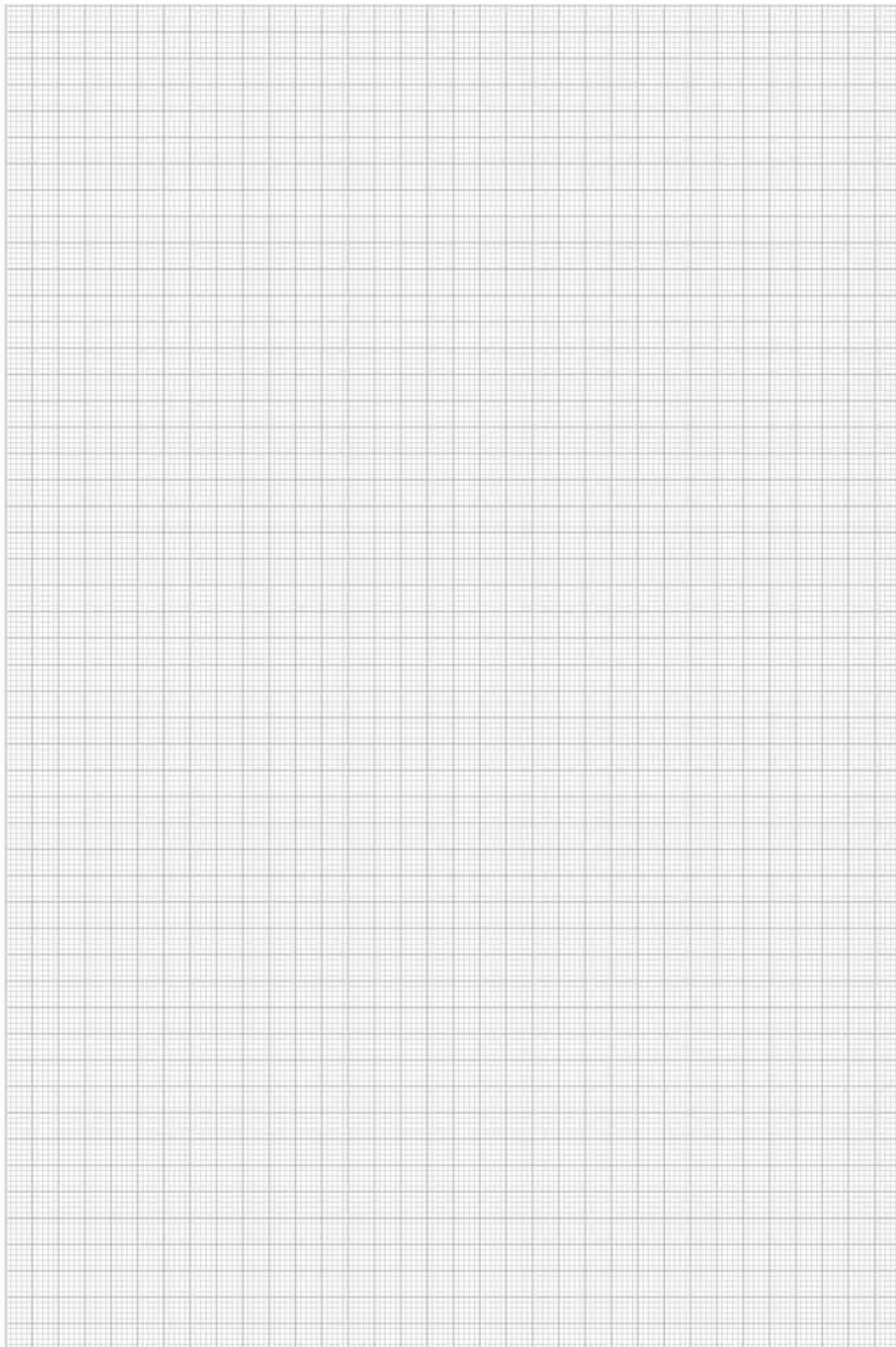

Selbsthaltende Wundsperrer
 Selfretaining Retractors
 Separadores autoestaticos
 Selfretaining Retractors
 Separadores autoestaticos



RUSKIN
KA 862/23
 23,0 cm/9"



SMITH-PETERSON
 24,0 cm/9 1/2"



3,0 mm
KA 863/03

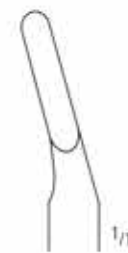

4,0 mm
KA 863/04



5,0 mm
KA 863/05



3,0 mm
KA 863/13



4,0 mm
KA 863/14



5,0 mm
KA 863/15

AA
 AB
 AC
 AD
 AE
 AF
 AG
 AH
 AI
 AJ
 AK
 AL
 AM
 AN
 AO
 AP
 AQ
 AR
KA
 KD
 KE
 KF
 KG
 KH
 KI
 KJ
 KK
 KL
 KM
 KN
 KO
 KP
 KQ
 KR
 KS
 KT
 KU
 KV

Hohlmeißelzangen
 Bone Rongeurs
 Pinzas-gubias
 Pincès-gouges
 Pinze-sgorbie

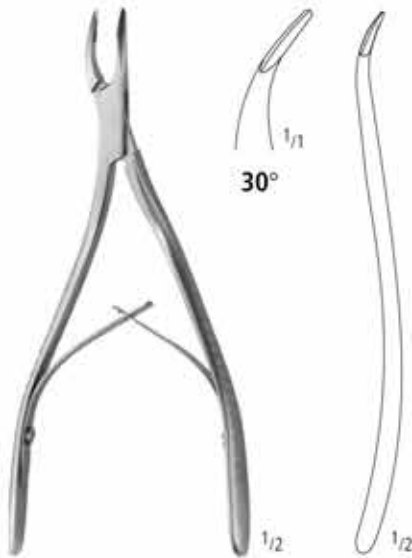

MICRO-FRIEDMAN
KA 865/14
 14,5 cm/5³/₄"

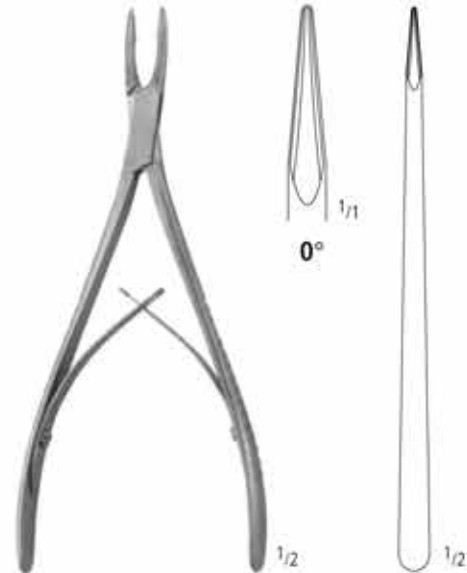

MICRO-FRIEDMAN
KA 866/15
 15,0 cm/6"

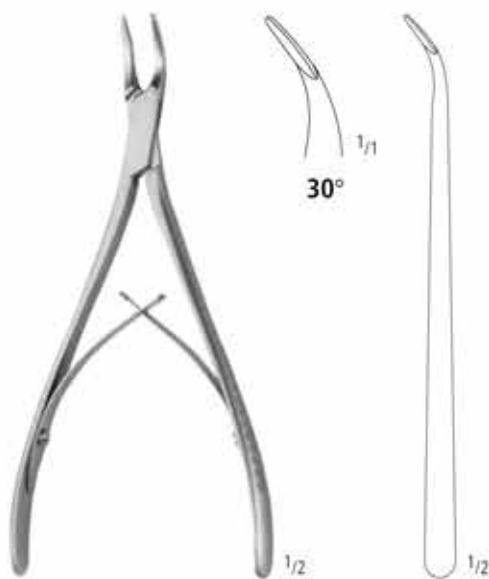

MICRO-FRIEDMAN
KA 867/15
 15,0 cm/6"

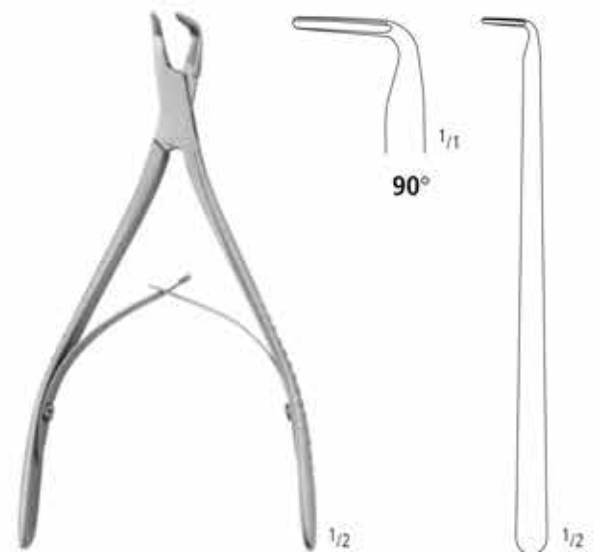

MICRO-FRIEDMAN
KA 868/15
 14,5 cm/5³/₄"

ORTHOPÄDIE ORTHOPAEDIC ORTOPEDIA ORTHOPEDIE ORTOPEDIA

Knochensplitterzangen
 Bone Cutting Forceps
 Pinzas cortantes para huesos
 Pinces coupantes à os
 Cesioie per ossa

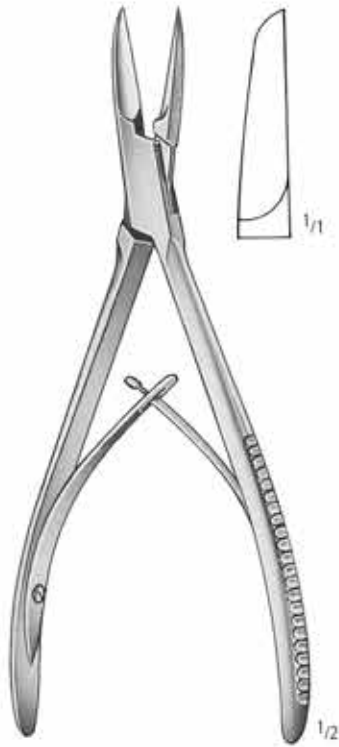

COTTLE KAZANJIAN
KA 870/19
 19,0 cm/7¹/₂"

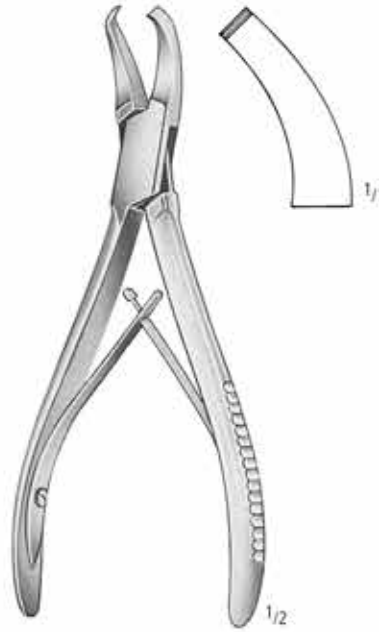

CLEVELAND-GARDNER
KA 872/16
 18,0 cm/6¹/₄"



MARKWALDER
KA 874/20
 20,0 cm/8"

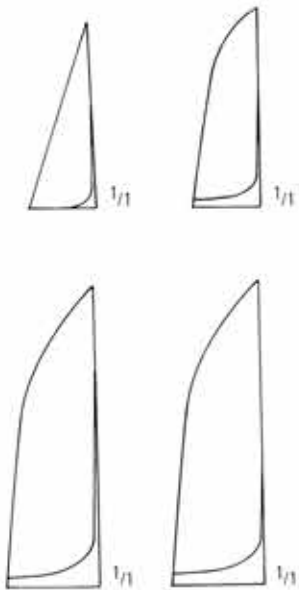

LISTON
 14,0 cm/5¹/₂"
 17,0 cm/6³/₄"
 19,0 cm/7¹/₂"
 22,0 cm/8³/₄"

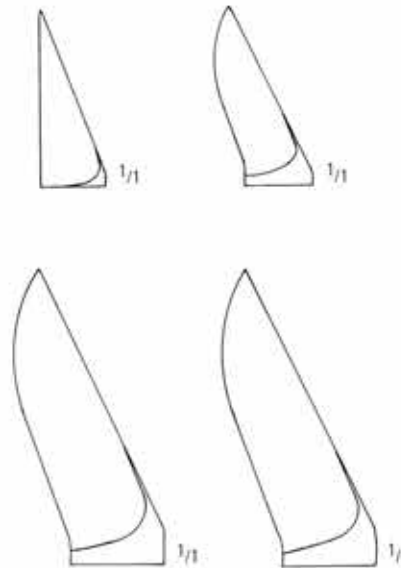

LITTAUER-LISTON
KA 882/15
 15,0 cm/6"

- KA 880/14
- KA 880/17
- KA 880/19
- KA 880/22

- KA 881/14
- KA 881/17
- KA 881/19
- KA 881/22

AA
 AB
 AC
 AD
 AE
 AF
 AG
 AH
 AI
 AJ
 AK
 AL
 AM
 AN
 AO
 AP
 AR
KA
 KD
 KE
 KF

Knochensplitterzangen
 Bone Cutting Forceps
 Pinzas cortantes para huesos
 Pincas coupantes à os
 Cesioie per ossa

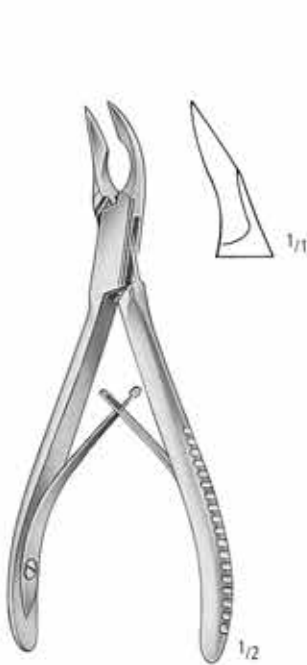

CLEVELAND
KA 884/15
 15,0 cm/6"



CLEVELAND
KA 884/17
 17,0 cm/6³/₄"



KA 885/12
 10,0 cm/4"

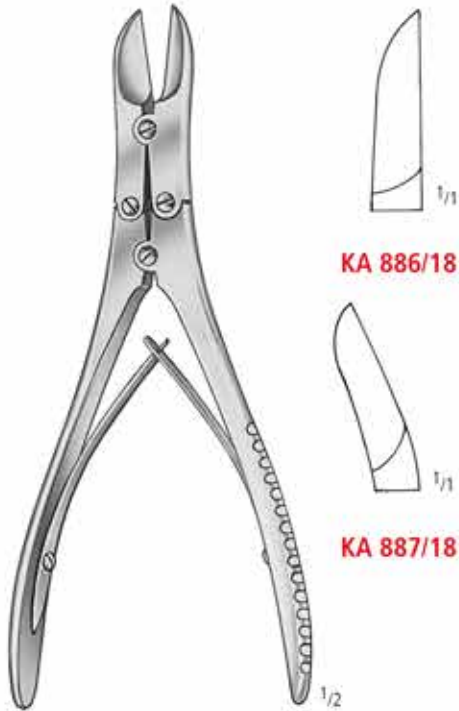

KA 886/18

KA 887/18

RUSKIN-LISTON
 18,5 cm/7¹/₄"



MC INDOE
KA 888/17
 17,5 cm/7"



WALTON-LISTON
KA 889/01
 15,0 cm/6"

Knochensplitterzangen
 Bone Cutting Forceps
 Pinzas cortantes para huesos
 Pincas coupantes à os
 Cesioie per ossa

AA
AB
AC
AD
AE
AF
AK
AL
AM
AO
AP
AR
KA
KD
KU
KY



STILLE-LISTON
 27,0 cm/10¹/₂"



KA 890/00



KA 890/30

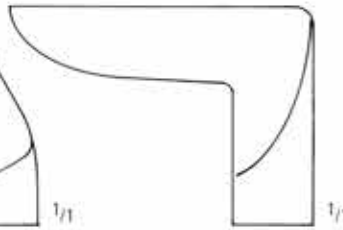

KA 890/90



LISTON-KEY (TUDOR-EDWARDS)
KA 892/27
 27,0 cm/10¹/₂"

Knochensplitterzangen
 Bone Cutting Forceps
 Pinzas cortantes para huesos
 Pincas coupantes à os
 Cesioie per ossa



SEMB
KA 893/24
 24,0 cm/9¹/₂"

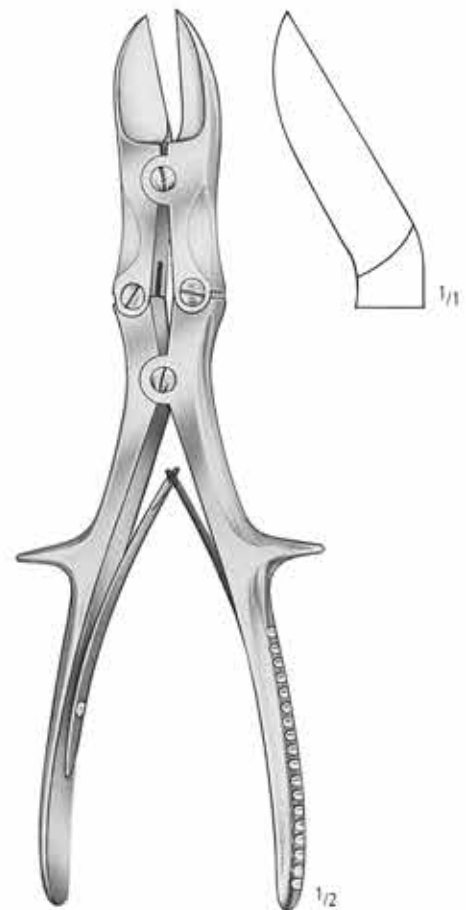

LISTON
KA 894/23
 23,5 cm/9¹/₄"

Elevatoren, Weisheitszahnhaken
 Elevators, Third molar hook
 Elevadores, Ganchito retractor de la muela del juicio
 Elevateur, Crochet à dent de sagesse
 Elevatori, Uncino per dente del giudizio



HENAHAN
 20,0 cm/8"



Fig. 1-1
KA 897/01



Fig. 1-2
KA 897/02



Fig. 1-3
KA 897/03



AA
 AB
 AC
 AD
 AE
 AF
 AG
 AH
 AI
 AJ
 AK
 AL
 AM
 AN
 AO
 AP
 AQ
 AR
KA
 KD
 KE
 KF
 KG
 KH
 KI
 KJ
 KK
 KL
 KM
 KN
 KO
 KP
 KQ
 KR
 KS
 KT
 KU
 KV

Bleihände, Fingerringsägen und Nagelzange
 Lead Hands, Finger Ring Saws and Nail Instrument
 Manoplas de plomo, sierras para abrir anillos y pinza para uñas
 Manches en plomb, scies pour bagues et pince à ongle
 Mani di piombo, seghe per anelli e pinza per unghie



KA 900/01
 für Kinder
 Child Size
 Para niños
 Pour enfants
 Per bambini

KA 900/02
 für Erwachsene
 Adult Size
 Para adultos
 Pour adultes
 Per adulti



KA 909/00

KA 908/17
 17,0 cm/6³/₄"



KA 911/00

WALTON
KA 910/17
 16,0 cm/6¹/₄"

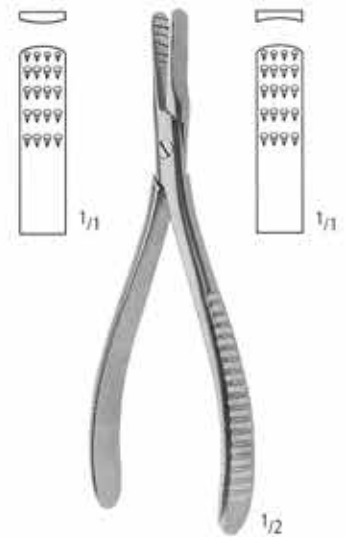

RADOLF
KA 918/13
 13,5 cm/5¹/₄"

Autopsie-Säge
Post Mortem Saw
Sierra para autopsia
Scie à autopsie
Sega per autopsia

OSCI nopa®

**Autoklavierbar
Autoclavable
Autoclavable
Autoclavable
Autoclavabile**



KA 995/00 = 230 V
(+ **KA 996/50 + KA 996/65 + KA 997/01 + KA 998/23 + KA 999/16**)
Euro-Flachstecker / EU-plug

KA 995/01 = 110 V
(+ **KA 996/50 + KA 996/65 + KA 997/01 + KA 998/23 + KA 999/16**)
USA-Stecker / USA-plug

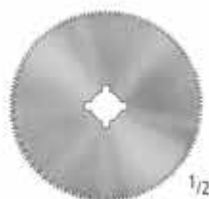

KA 996/50 = Ø 50 mm
KA 996/65 = Ø 65 mm

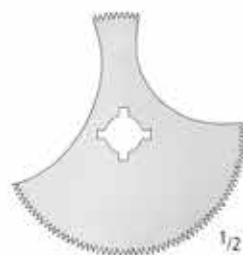

KA 997/01



KA 998/23



KA 999/16
16,0 cm/6¼"

AA
AB
AC
AD
AE
AF
AK
AL
AM
AO
AP
AR
KA
KD
KU
KY

Autopsie-Säge
 Post Mortem Saw
 Sierra para autopsia
 Scie à autopsie
 Sega per autopsia

nopa[®] P R O F I



KA 995/10 = 230 V
 (+ **KA 996/50** + **KA 996/65** + **KA 997/01** + **KA 997/39** + **KA 998/24** + **KA 999/16**)
 Euro-Flachstecker / EU-plug
KA 995/11 = 110 V
 (+ **KA 996/50** + **KA 996/65** + **KA 997/01** + **KA 997/39** + **KA 998/24** + **KA 999/16**)
 USA-Stecker / USA-plug



KA 996/50 = Ø 50 mm
KA 996/65 = Ø 65 mm

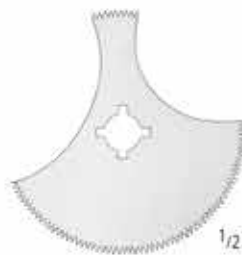

KA 997/01



KA 997/39



KA 998/24



KA 999/16
 16,0 cm/6¹/₄"

Autopsie-Säge
 Post Mortem Saw
 Sierra para autopsia
 Scie à autopsie
 Sega per autopsia

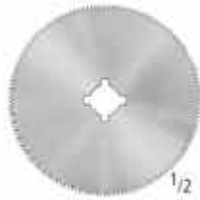

KA 996/50 = Ø 50 mm
KA 996/65 = Ø 65 mm



KA 997/01



KA 997/02 = 8 mm
KA 997/03 = 20 mm

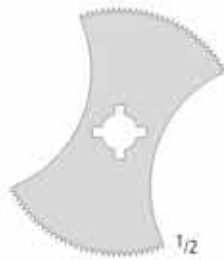

KA 997/04



KA 997/05

nur für **nopa** PROF I
 only for **nopa** PROF I



KA 997/11



KA 997/39



KA 997/58

AA
 AB
 AC
 AD
 AE
 AF
 AG
 AH
 AI
 AJ
 AK
 AL
 AM
 AN
 AO
 AP
 AQ
 AR
KA
 KD
 KE
 KF
 KG
 KH
 KI
 KJ
 KK
 KL
 KM
 KN
 KO
 KP
 KQ
 KR
 KS
 KT
 KU
 KV
 KW
 KY



Repositionszangen
 Reposition Forceps
 Pinzas de reposicion
 Pincas de reposition
 Pinze per riposizione



ROWE
KA 2970/23
 23,0 cm/9"



ROWE
KA 2971/23
 23,0 cm/9"

AA
 AB
 AC
 AD
 AE
 AF
 AK
 AL
 AM
 AO
 AP
 AR
 KA
 KD
 KU
 KY

KA

Instrumentarium für Küntscher - Nägel
 Instruments for Küntscher Nails
 Instrumentos para clavos Küntscher
 Instrumentation pour les clous de Küntscher
 Strumenti per chiodi Küntscher



KÜNTSCHER
KA 4900/01



KÜNTSCHER
KA 4900/02



KÜNTSCHER
KA 4900/03



KA 4901/00



29,0 cm/11¹/₂" **KA 4902/29**
 37,0 cm/14¹/₂" **KA 4902/37**
 42,0 cm/16¹/₂" **KA 4902/42**
 49,0 cm/19¹/₄" **KA 4902/49**

Instrumentarium für Küntscher - Nägel
 Instruments for Küntscher Nails
 Instrumentos para clavos Küntscher
 Instrumentation pour les clous de Küntscher
 Strumenti per chiodi Küntscher

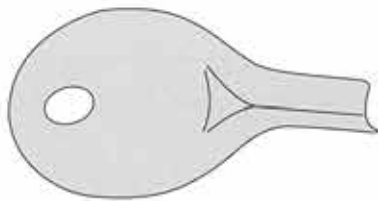

KA 4913/00



**KÜNTSCHER
KA 4913/26**



**KÜNTSCHER
KA 4913/35**



Führungsspieß - Guide Pin - Tallo guía - Guide broche - Spiedo da guida

cm	inch
35,0	14
46,0	18
60,0	23 ¹ / ₂

Ø 3,0 mm
KA 4915/35
KA 4915/46

für Nägel bis
 for nails up to
 para clavos hasta
 pour clous jusqu'à
 per chiodi fino a
 Ø 8,0 mm

Ø 3,5 mm
KA 4916/35
KA 4916/46
KA 4916/60

für Nägel
 for nails
 para clavos
 pour clous
 per chiodi
 Ø 9,0 mm
 Ø 10,0 mm
 Ø 11,0 mm

Ø 4,0 mm
KA 4917/35
KA 4917/46
KA 4917/60

Ø 5,0 mm
KA 4918/35
KA 4918/46
KA 4918/60

für Nägel ab
 for nails from
 para clavos desde
 pour clous à partir de
 per chiodi a partire da
 Ø 11,0 mm

AA
AB
AC
AD
AE
AF
AK
AL
AM
AO
AP
AR
KA
KD
KY

Zubehör für Haken-Marknägel
 Accessories for Intramedullary Pins with Hooks
 Accesorios para clavos intramedulares con ganchos
 Accessoires pour broches centro-médullaires
 Accessori per chiodi centromidollari con gancio

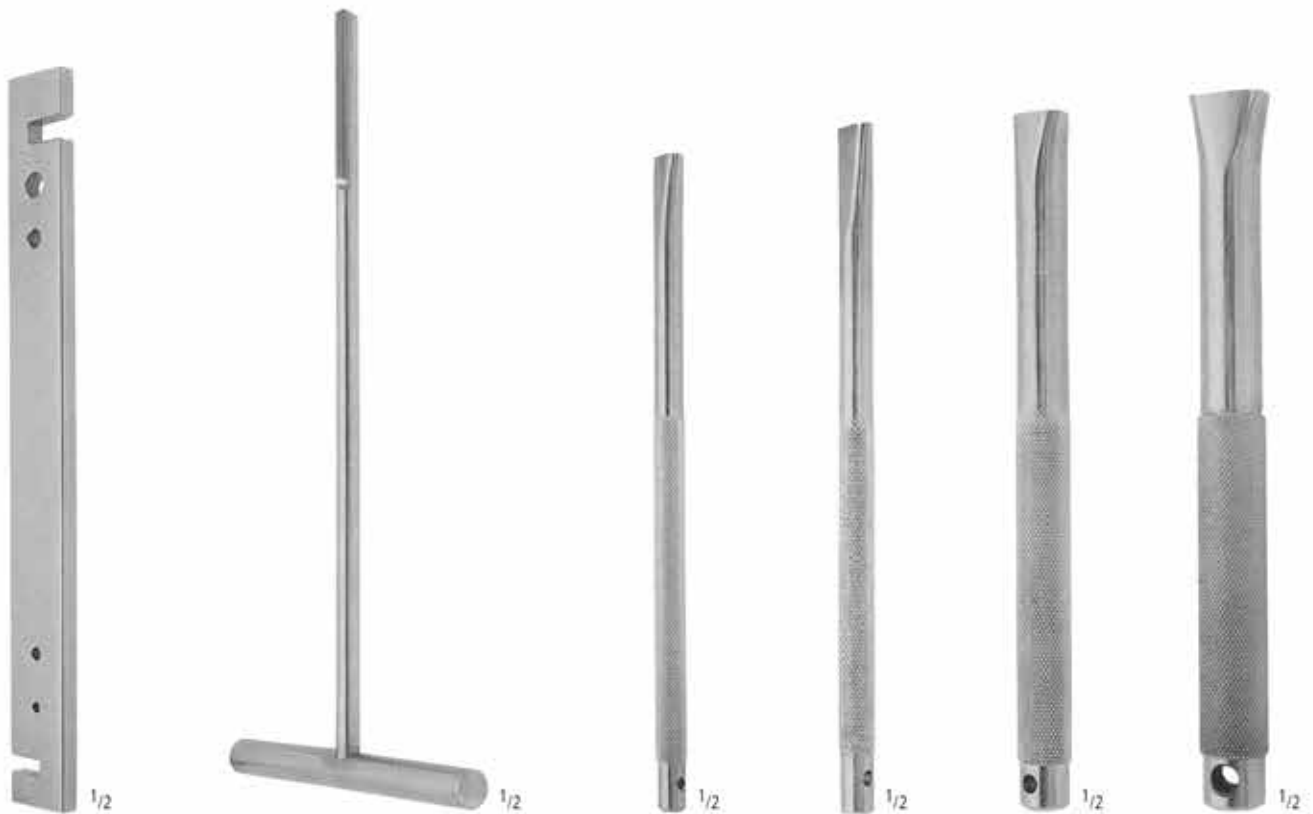

KA 4919/20

Ø 2,5 mm **KA 4920/02**
 Ø 3,0 mm **KA 4920/03**
 Ø 5,0 mm **KA 4920/05**
 Ø 6,0 mm **KA 4920/06**

Ø 2,5 mm **KA 4922/02**

Ø 3,0 mm **KA 4922/03**

Ø 5,0 mm **KA 4922/05**

Ø 6,0 mm **KA 4922/06**

Schraubenzieher
Screw Drivers
Destornilladores
Tournevis
Giravite

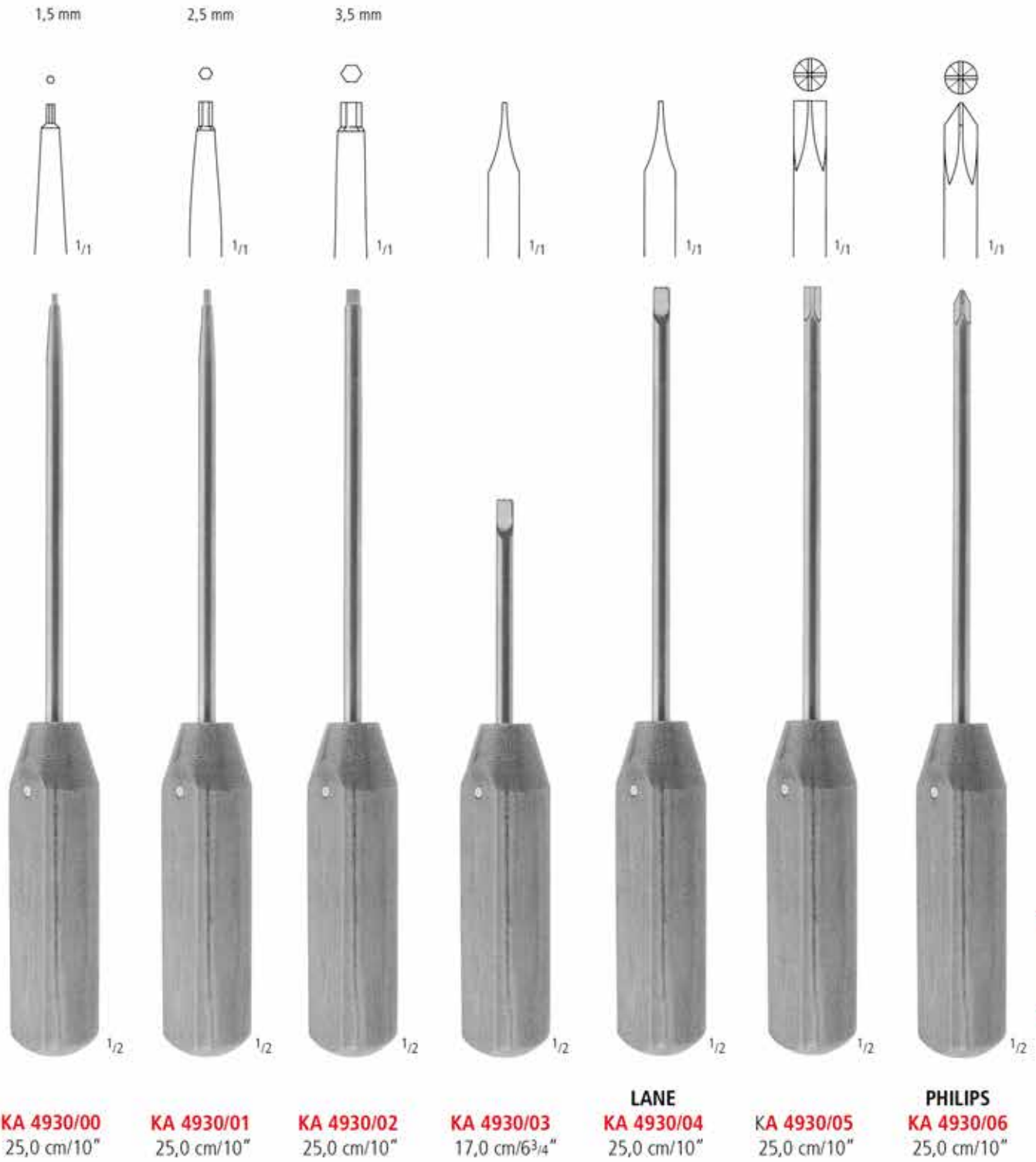

AA
AB
AC
AD
AE
AF
AK
AL
AM
AO
AP
AR
KA
KD
KU
KY

KA ORTHOPÄDIE ORTHOPAEDIC ORTOPEDIA ORTHOPEDIE ORTOPEZIA

Marknägel, rund, mit Haken
 Intramedullary Pins, round, with hook
 Clavos intramedulares, redondos, con gancho
 Broches à crochet pour enclouage centro-médullaire, rondes
 Chiodi a gancio per inchiodamento centromidollare, rotondi

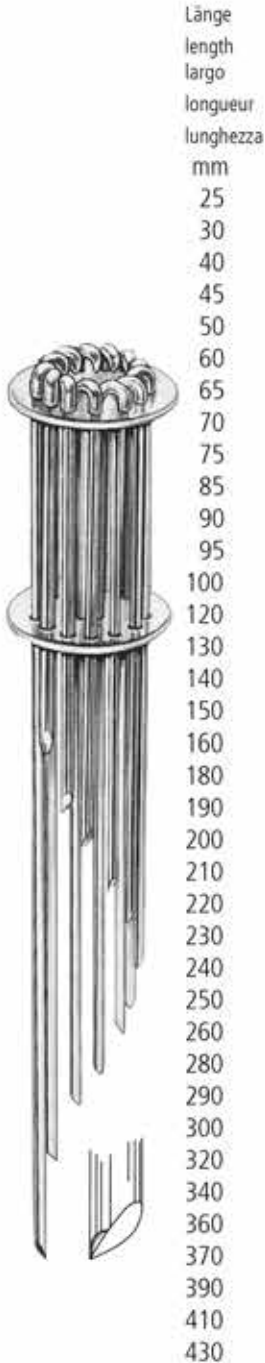

Satz - set - juego - jeu - serie

Länge length largo longueur lunghezza mm	KA 5080/00 Ø 2,5 mm	KA 5081/00 Ø 3,0 mm	KA 5082/00 Ø 5,0 mm	KA 5083/00 Ø 5,0 mm
25	KA 5080/25			
30	KA 5080/30			
40	KA 5080/40			
45	KA 5080/45			
50	KA 5080/50			
60	KA 5080/60			
65	KA 5080/65			
70	KA 5080/70			
75	KA 5080/75			
85	KA 5080/85			
90	KA 5080/90			
95	KA 5080/95			
100	KA 5080/99	KA 5081/10		
120		KA 5081/12		
130		KA 5081/13		
140		KA 5081/14		
150		KA 5081/15		
160		KA 5081/16		
180		KA 5081/18		
190		KA 5081/19		
200		KA 5081/20	KA 5082/20	
210		KA 5081/21		
220			KA 5082/22	
230		KA 5081/23		
240		KA 5081/24	KA 5082/24	
250		KA 5081/25		
260			KA 5082/26	
280			KA 5082/28	KA 5083/28
290				KA 5083/29
300			KA 5082/30	
320			KA 5082/32	KA 5083/32
340			KA 5082/34	KA 5083/34
360			KA 5082/36	KA 5083/36
370				KA 5083/37
390				KA 5083/39
410				KA 5083/41
430				KA 5083/43
	KA 5080/00 KA 5080/25 - KA 5080/99	KA 5081/00 KA 5081/10 - KA 5081/25	KA 5082/00 KA 5082/20 - KA 5082/36	KA 5083/00 KA 5083/28 - KA 5083/43
Unter-	für Finger und Fuß	für Unterarm und Clavicula	für Unterschenkel und Oberarm	für Ober- und
	for small bones para huesos pequeños pour les petits os per le ossa piccole	for radius, ulna and clavica para radio, ulna y clavícula pour radius, cubitus et clavicule per radio, ulna e clavicola	for tibia and humeros para tibia y humero pour tibia et humérus per tibia e omero	schenkel for femur and tibia para fémur y tibia pour fémur et tibia per femore e tibia

Nägel, Klammern
Fracture Pins, Clips
Clavos para huesos, Grapas
Clous à os, agrafes
Chiodi per ossa, grappas

WILDBERG



KA 5087/16



KA 5087/19



KA 5087/22



PALMER
Ø 1,5 mm

KA 5090/15	15 mm
KA 5090/20	20 mm
KA 5090/25	25 mm
KA 5090/35	35 mm
KA 5090/40	40 mm
KA 5090/45	45 mm
KA 5090/50	50 mm
KA 5090/55	55 mm
KA 5090/60	60 mm
KA 5090/65	65 mm
KA 5090/70	70 mm

AA
AB
AC
AD
AE
AF
AK
AL
AM
AO
AP
AR
KA
KD
KU
KY

Steinmann Nägel
 Steinmann Pins
 Clavos Steinmann
 Clous Steinmann
 Aghi Steinmann



	3,2 mm	3,5 mm	4,0 mm	4,2 mm	4,5 mm	4,8 mm	5,0 mm	5,5 mm	6,0 mm
10,0 cm	KA 5301/10	KA 5302/10	KA 5303/10	KA 5304/10	KA 5305/10	KA 5306/10	KA 5307/10	KA 5308/10	KA 5309/10
15,0 cm	KA 5301/15	KA 5302/15	KA 5303/15	KA 5304/15	KA 5305/15	KA 5306/15	KA 5307/15	KA 5308/15	KA 5309/15
18,0 cm	KA 5301/18	KA 5302/18	KA 5303/18	KA 5304/18	KA 5305/18	KA 5306/18	KA 5307/18	KA 5308/18	KA 5309/18
20,0 cm	KA 5301/20	KA 5302/20	KA 5303/20	KA 5304/20	KA 5305/20	KA 5306/20	KA 5307/20	KA 5308/20	KA 5309/20
22,0 cm	KA 5301/22	KA 5302/22	KA 5303/22	KA 5304/22	KA 5305/22	KA 5306/22	KA 5307/22	KA 5308/22	KA 5309/22
23,5 cm	KA 5301/23	KA 5302/23	KA 5303/23	KA 5304/23	KA 5305/23	KA 5306/23	KA 5307/23	KA 5308/23	KA 5309/23
25,0 cm	KA 5301/25	KA 5302/25	KA 5303/25	KA 5304/25	KA 5305/25	KA 5306/25	KA 5307/25	KA 5308/25	KA 5309/25
28,0 cm	KA 5301/28	KA 5302/28	KA 5303/28	KA 5304/28	KA 5305/28	KA 5306/28	KA 5307/28	KA 5308/28	KA 5309/28
30,0 cm	KA 5301/30	KA 5302/30	KA 5303/30	KA 5304/30	KA 5305/30	KA 5306/30	KA 5307/30	KA 5308/30	KA 5309/30



	3,2 mm	3,5 mm	4,0 mm	4,2 mm	4,5 mm	4,8 mm	5,0 mm	5,5 mm	6,0 mm
10,0 cm	KA 5311/10	KA 5312/10	KA 5313/10	KA 5314/10	KA 5315/10	KA 5316/10	KA 5317/10	KA 5318/10	KA 5319/10
15,0 cm	KA 5311/15	KA 5312/15	KA 5313/15	KA 5314/15	KA 5315/15	KA 5316/15	KA 5317/15	KA 5318/15	KA 5319/15
18,0 cm	KA 5311/18	KA 5312/18	KA 5313/18	KA 5314/18	KA 5315/18	KA 5316/18	KA 5317/18	KA 5318/18	KA 5319/18
20,0 cm	KA 5311/20	KA 5312/20	KA 5313/20	KA 5314/20	KA 5315/20	KA 5316/20	KA 5317/20	KA 5318/20	KA 5319/20
22,0 cm	KA 5311/22	KA 5312/22	KA 5313/22	KA 5314/22	KA 5315/22	KA 5316/22	KA 5317/22	KA 5318/22	KA 5319/22
23,5 cm	KA 5311/23	KA 5312/23	KA 5313/23	KA 5314/23	KA 5315/23	KA 5316/23	KA 5317/23	KA 5318/23	KA 5319/23
25,0 cm	KA 5311/25	KA 5312/25	KA 5313/25	KA 5314/25	KA 5315/25	KA 5316/25	KA 5317/25	KA 5318/25	KA 5319/25
28,0 cm	KA 5311/28	KA 5312/28	KA 5313/28	KA 5314/28	KA 5315/28	KA 5316/28	KA 5317/28	KA 5318/28	KA 5319/28
30,0 cm	KA 5311/30	KA 5312/30	KA 5313/30	KA 5314/30	KA 5315/30	KA 5316/30	KA 5317/30	KA 5318/30	KA 5319/30

ORTHOPÄDIE ORTHOPAEDIC ORTOPEDIA ORTHOPEDIE ORTOPEDIA

Steinmann Nägel
Steinmann Pins
Clavos Steinmann
Clous Steinmann
Aghi Steinmann



STEINMANN

	3,2 mm	3,5 mm	4,0 mm	4,2 mm	4,5 mm	4,8 mm	5,0 mm	5,5 mm	6,0 mm
10,0 cm	KA 5321/10	KA 5322/10	KA 5323/10	KA 5324/10	KA 5325/10	KA 5326/10	KA 5327/10	KA 5328/10	KA 5329/10
15,0 cm	KA 5321/15	KA 5322/15	KA 5323/15	KA 5324/15	KA 5325/15	KA 5326/15	KA 5327/15	KA 5328/15	KA 5329/15
18,0 cm	KA 5321/18	KA 5322/18	KA 5323/18	KA 5324/18	KA 5325/18	KA 5326/18	KA 5327/18	KA 5328/18	KA 5329/18
20,0 cm	KA 5321/20	KA 5322/20	KA 5323/20	KA 5324/20	KA 5325/20	KA 5326/20	KA 5327/20	KA 5328/20	KA 5329/20
22,0 cm	KA 5321/22	KA 5322/22	KA 5323/22	KA 5324/22	KA 5325/22	KA 5326/22	KA 5327/22	KA 5328/22	KA 5329/22
23,5 cm	KA 5321/23	KA 5322/23	KA 5323/23	KA 5324/23	KA 5325/23	KA 5326/23	KA 5327/23	KA 5328/23	KA 5329/23
25,0 cm	KA 5321/25	KA 5322/25	KA 5323/25	KA 5324/25	KA 5325/25	KA 5326/25	KA 5327/25	KA 5328/25	KA 5329/25
28,0 cm	KA 5321/28	KA 5322/28	KA 5323/28	KA 5324/28	KA 5325/28	KA 5326/28	KA 5327/28	KA 5328/28	KA 5329/28
30,0 cm	KA 5321/30	KA 5322/30	KA 5323/30	KA 5324/30	KA 5325/30	KA 5326/30	KA 5327/30	KA 5328/30	KA 5329/30



STEINMANN

	3,2 mm	3,5 mm	4,0 mm	4,2 mm	4,5 mm	4,8 mm	5,0 mm	5,5 mm	6,0 mm
10,0 cm	KA 5331/10	KA 5332/10	KA 5333/10	KA 5334/10	KA 5335/10	KA 5336/10	KA 5337/10	KA 5338/10	KA 5339/10
15,0 cm	KA 5331/15	KA 5332/15	KA 5333/15	KA 5334/15	KA 5335/15	KA 5336/15	KA 5337/15	KA 5338/15	KA 5339/15
18,0 cm	KA 5331/18	KA 5332/18	KA 5333/18	KA 5334/18	KA 5335/18	KA 5336/18	KA 5337/18	KA 5338/18	KA 5339/18
20,0 cm	KA 5331/20	KA 5332/20	KA 5333/20	KA 5334/20	KA 5335/20	KA 5336/20	KA 5337/20	KA 5338/20	KA 5339/20
22,0 cm	KA 5331/22	KA 5332/22	KA 5333/22	KA 5334/22	KA 5335/22	KA 5336/22	KA 5337/22	KA 5338/22	KA 5339/22
23,5 cm	KA 5331/23	KA 5332/23	KA 5333/23	KA 5334/23	KA 5335/23	KA 5336/23	KA 5337/23	KA 5338/23	KA 5339/23
25,0 cm	KA 5331/25	KA 5332/25	KA 5333/25	KA 5334/25	KA 5335/25	KA 5336/25	KA 5337/25	KA 5338/25	KA 5339/25
28,0 cm	KA 5331/28	KA 5332/28	KA 5333/28	KA 5334/28	KA 5335/28	KA 5336/28	KA 5337/28	KA 5338/28	KA 5339/28
30,0 cm	KA 5331/30	KA 5332/30	KA 5333/30	KA 5334/30	KA 5335/30	KA 5336/30	KA 5337/30	KA 5338/30	KA 5339/30

AA
AB
AC
AD
AE
AF
AK
AL
AM
AO
AP
AR
KA
KD
KU
KY

Kirschner Bohrdrähte
Kirschner Wires
Agujas Kirschner
Broches de Kirschner
Fili Kirschner



KIRSCHNER

	60 mm	70 mm	80 mm	120 mm	140 mm	160 mm	230 mm	310 mm
0,6 mm	KA 5401/06	KA 5402/06	KA 5403/06	KA 5404/06	KA 5405/06	KA 5406/06	KA 5407/06	KA 5408/06
0,8 mm	KA 5401/08	KA 5402/08	KA 5403/08	KA 5404/08	KA 5405/08	KA 5406/08	KA 5407/08	KA 5408/08
0,9 mm	KA 5401/09	KA 5402/09	KA 5403/09	KA 5404/09	KA 5405/09	KA 5406/09	KA 5407/09	KA 5408/09
1,0 mm	KA 5401/10	KA 5402/10	KA 5403/10	KA 5404/10	KA 5405/10	KA 5406/10	KA 5407/10	KA 5408/10
1,2 mm	KA 5401/12	KA 5402/12	KA 5403/12	KA 5404/12	KA 5405/12	KA 5406/12	KA 5407/12	KA 5408/12
1,4 mm	KA 5401/14	KA 5402/14	KA 5403/14	KA 5404/14	KA 5405/14	KA 5406/14	KA 5407/14	KA 5408/14
1,5 mm	KA 5401/15	KA 5402/15	KA 5403/15	KA 5404/15	KA 5405/15	KA 5406/15	KA 5407/15	KA 5408/15
1,6 mm	KA 5401/16	KA 5402/16	KA 5403/16	KA 5404/16	KA 5405/16	KA 5406/16	KA 5407/16	KA 5408/16
1,7 mm	KA 5401/17	KA 5402/17	KA 5403/17	KA 5404/17	KA 5405/17	KA 5406/17	KA 5407/17	KA 5408/17
1,8 mm	KA 5401/18	KA 5402/18	KA 5403/18	KA 5404/18	KA 5405/18	KA 5406/18	KA 5407/18	KA 5408/18
2,0 mm	KA 5401/20	KA 5402/20	KA 5403/20	KA 5404/20	KA 5405/20	KA 5406/20	KA 5407/20	KA 5408/20
2,2 mm	KA 5401/22	KA 5402/22	KA 5403/22	KA 5404/22	KA 5405/22	KA 5406/22	KA 5407/22	KA 5408/22
2,5 mm	KA 5401/25	KA 5402/25	KA 5403/25	KA 5404/25	KA 5405/25	KA 5406/25	KA 5407/25	KA 5408/25
3,0 mm	KA 5401/30	KA 5402/30	KA 5403/30	KA 5404/30	KA 5405/30	KA 5406/30	KA 5407/30	KA 5408/30



KIRSCHNER

	60 mm	70 mm	80 mm	120 mm	140 mm	160 mm	230 mm	310 mm
0,6 mm	KA 5411/06	KA 5412/06	KA 5413/06	KA 5414/06	KA 5415/06	KA 5416/06	KA 5417/06	KA 5418/06
0,8 mm	KA 5411/08	KA 5412/08	KA 5413/08	KA 5414/08	KA 5415/08	KA 5416/08	KA 5417/08	KA 5418/08
0,9 mm	KA 5411/09	KA 5412/09	KA 5413/09	KA 5414/09	KA 5415/09	KA 5416/09	KA 5417/09	KA 5418/09
1,0 mm	KA 5411/10	KA 5412/10	KA 5413/10	KA 5414/10	KA 5415/10	KA 5416/10	KA 5417/10	KA 5418/10
1,2 mm	KA 5411/12	KA 5412/12	KA 5413/12	KA 5414/12	KA 5415/12	KA 5416/12	KA 5417/12	KA 5418/12
1,4 mm	KA 5411/14	KA 5412/14	KA 5413/14	KA 5414/14	KA 5415/14	KA 5416/14	KA 5417/14	KA 5418/14
1,5 mm	KA 5411/15	KA 5412/15	KA 5413/15	KA 5414/15	KA 5415/15	KA 5416/15	KA 5417/15	KA 5418/15
1,6 mm	KA 5411/16	KA 5412/16	KA 5413/16	KA 5414/16	KA 5415/16	KA 5416/16	KA 5417/16	KA 5418/16
1,7 mm	KA 5411/17	KA 5412/17	KA 5413/17	KA 5414/17	KA 5415/17	KA 5416/17	KA 5417/17	KA 5418/17
1,8 mm	KA 5411/18	KA 5412/18	KA 5413/18	KA 5414/18	KA 5415/18	KA 5416/18	KA 5417/18	KA 5418/18
2,0 mm	KA 5411/20	KA 5412/20	KA 5413/20	KA 5414/20	KA 5415/20	KA 5416/20	KA 5417/20	KA 5418/20
2,2 mm	KA 5411/22	KA 5412/22	KA 5413/22	KA 5414/22	KA 5415/22	KA 5416/22	KA 5417/22	KA 5418/22
2,5 mm	KA 5411/25	KA 5412/25	KA 5413/25	KA 5414/25	KA 5415/25	KA 5416/25	KA 5417/25	KA 5418/25
3,0 mm	KA 5411/30	KA 5412/30	KA 5413/30	KA 5414/30	KA 5415/30	KA 5416/30	KA 5417/30	KA 5418/30

ORTHOPÄDIE ORTHOPAEDIC ORTOPEDIA ORTHOPEDIE ORTOPEDIA

Kirschner Bohrdrähte
Kirschner Wires
Agujas Kirschner
Broches de Kirschner
Fili Kirschner

AA
AB
AC
AD
AE
AF
AK
AL
AM
AO
AP
AR
KA
KD
KY



	60 mm	70 mm	80 mm	120 mm	140 mm	160 mm	230 mm	310 mm
0,6 mm	KA 5421/06	KA 5422/06	KA 5423/06	KA 5424/06	KA 5425/06	KA 5426/06	KA 5427/06	KA 5428/06
0,8 mm	KA 5421/08	KA 5422/08	KA 5423/08	KA 5424/08	KA 5425/08	KA 5426/08	KA 5427/08	KA 5428/08
0,9 mm	KA 5421/09	KA 5422/09	KA 5423/09	KA 5424/09	KA 5425/09	KA 5426/09	KA 5427/09	KA 5428/09
1,0 mm	KA 5421/10	KA 5422/10	KA 5423/10	KA 5424/10	KA 5425/10	KA 5426/10	KA 5427/10	KA 5428/10
1,2 mm	KA 5421/12	KA 5422/12	KA 5423/12	KA 5424/12	KA 5425/12	KA 5426/12	KA 5427/12	KA 5428/12
1,4 mm	KA 5421/14	KA 5422/14	KA 5423/14	KA 5424/14	KA 5425/14	KA 5426/14	KA 5427/14	KA 5428/14
1,5 mm	KA 5421/15	KA 5422/15	KA 5423/15	KA 5424/15	KA 5425/15	KA 5426/15	KA 5427/15	KA 5428/15
1,6 mm	KA 5421/16	KA 5422/16	KA 5423/16	KA 5424/16	KA 5425/16	KA 5426/16	KA 5427/16	KA 5428/16
1,7 mm	KA 5421/17	KA 5422/17	KA 5423/17	KA 5424/17	KA 5425/17	KA 5426/17	KA 5427/17	KA 5428/17
1,8 mm	KA 5421/18	KA 5422/18	KA 5423/18	KA 5424/18	KA 5425/18	KA 5426/18	KA 5427/18	KA 5428/18
2,0 mm	KA 5421/20	KA 5422/20	KA 5423/20	KA 5424/20	KA 5425/20	KA 5426/20	KA 5427/20	KA 5428/20
2,2 mm	KA 5421/22	KA 5422/22	KA 5423/22	KA 5424/22	KA 5425/22	KA 5426/22	KA 5427/22	KA 5428/22
2,5 mm	KA 5421/25	KA 5422/25	KA 5423/25	KA 5424/25	KA 5425/25	KA 5426/25	KA 5427/25	KA 5428/25
3,0 mm	KA 5421/30	KA 5422/30	KA 5423/30	KA 5424/30	KA 5425/30	KA 5426/30	KA 5427/30	KA 5428/30



	60 mm	70 mm	80 mm	120 mm	140 mm	160 mm	230 mm	310 mm
0,6 mm	KA 5431/06	KA 5432/06	KA 5433/06	KA 5434/06	KA 5435/06	KA 5436/06	KA 5437/06	KA 5438/06
0,8 mm	KA 5431/08	KA 5432/08	KA 5433/08	KA 5434/08	KA 5435/08	KA 5436/08	KA 5437/08	KA 5438/08
0,9 mm	KA 5431/09	KA 5432/09	KA 5433/09	KA 5434/09	KA 5435/09	KA 5436/09	KA 5437/09	KA 5438/09
1,0 mm	KA 5431/10	KA 5432/10	KA 5433/10	KA 5434/10	KA 5435/10	KA 5436/10	KA 5437/10	KA 5438/10
1,2 mm	KA 5431/12	KA 5432/12	KA 5433/12	KA 5434/12	KA 5435/12	KA 5436/12	KA 5437/12	KA 5438/12
1,4 mm	KA 5431/14	KA 5432/14	KA 5433/14	KA 5434/14	KA 5435/14	KA 5436/14	KA 5437/14	KA 5438/14
1,5 mm	KA 5431/15	KA 5432/15	KA 5433/15	KA 5434/15	KA 5435/15	KA 5436/15	KA 5437/15	KA 5438/15
1,6 mm	KA 5431/16	KA 5432/16	KA 5433/16	KA 5434/16	KA 5435/16	KA 5436/16	KA 5437/16	KA 5438/16
1,7 mm	KA 5431/17	KA 5432/17	KA 5433/17	KA 5434/17	KA 5435/17	KA 5436/17	KA 5437/17	KA 5438/17
1,8 mm	KA 5431/18	KA 5432/18	KA 5433/18	KA 5434/18	KA 5435/18	KA 5436/18	KA 5437/18	KA 5438/18
2,0 mm	KA 5431/20	KA 5432/20	KA 5433/20	KA 5434/20	KA 5435/20	KA 5436/20	KA 5437/20	KA 5438/20
2,2 mm	KA 5431/22	KA 5432/22	KA 5433/22	KA 5434/22	KA 5435/22	KA 5436/22	KA 5437/22	KA 5438/22
2,5 mm	KA 5431/25	KA 5432/25	KA 5433/25	KA 5434/25	KA 5435/25	KA 5436/25	KA 5437/25	KA 5438/25
3,0 mm	KA 5431/30	KA 5432/30	KA 5433/30	KA 5434/30	KA 5435/30	KA 5436/30	KA 5437/30	KA 5438/30

KA ORTHOPÄDIE ORTHOPAEDIC ORTOPEDIA ORTHOPEDIE ORTOPEZIA

Kirschner Bohrdrähte
Kirschner Wires
Agujas Kirschner
Broches de Kirschner
Fili Kirschner



KIRSCHNER

	60 mm	70 mm	80 mm	120 mm	140 mm	160 mm	230 mm	310 mm
0,6 mm	KA 5451/06	KA 5452/06	KA 5453/06	KA 5454/06	KA 5455/06	KA 5456/06	KA 5457/06	KA 5458/06
0,8 mm	KA 5451/08	KA 5452/08	KA 5453/08	KA 5454/08	KA 5455/08	KA 5456/08	KA 5457/08	KA 5458/08
0,9 mm	KA 5451/09	KA 5452/09	KA 5453/09	KA 5454/09	KA 5455/09	KA 5456/09	KA 5457/09	KA 5458/09
1,0 mm	KA 5451/10	KA 5452/10	KA 5453/10	KA 5454/10	KA 5455/10	KA 5456/10	KA 5457/10	KA 5458/10
1,2 mm	KA 5451/12	KA 5452/12	KA 5453/12	KA 5454/12	KA 5455/12	KA 5456/12	KA 5457/12	KA 5458/12
1,4 mm	KA 5451/14	KA 5452/14	KA 5453/14	KA 5454/14	KA 5455/14	KA 5456/14	KA 5457/14	KA 5458/14
1,5 mm	KA 5451/15	KA 5452/15	KA 5453/15	KA 5454/15	KA 5455/15	KA 5456/15	KA 5457/15	KA 5458/15
1,6 mm	KA 5451/16	KA 5452/16	KA 5453/16	KA 5454/16	KA 5455/16	KA 5456/16	KA 5457/16	KA 5458/16
1,7 mm	KA 5451/17	KA 5452/17	KA 5453/17	KA 5454/17	KA 5455/17	KA 5456/17	KA 5457/17	KA 5458/17
1,8 mm	KA 5451/18	KA 5452/18	KA 5453/18	KA 5454/18	KA 5455/18	KA 5456/18	KA 5457/18	KA 5458/18
2,0 mm	KA 5451/20	KA 5452/20	KA 5453/20	KA 5454/20	KA 5455/20	KA 5456/20	KA 5457/20	KA 5458/20
2,2 mm	KA 5451/22	KA 5452/22	KA 5453/22	KA 5454/22	KA 5455/22	KA 5456/22	KA 5457/22	KA 5458/22
2,5 mm	KA 5451/25	KA 5452/25	KA 5453/25	KA 5454/25	KA 5455/25	KA 5456/25	KA 5457/25	KA 5458/25
3,0 mm	KA 5451/30	KA 5452/30	KA 5453/30	KA 5454/30	KA 5455/30	KA 5456/30	KA 5457/30	KA 5458/30



KIRSCHNER

	60 mm	70 mm	80 mm	120 mm	140 mm	160 mm	230 mm	310 mm
0,6 mm	KA 5461/06	KA 5462/06	KA 5463/06	KA 5464/06	KA 5465/06	KA 5466/06	KA 5467/06	KA 5468/06
0,8 mm	KA 5461/08	KA 5462/08	KA 5463/08	KA 5464/08	KA 5465/08	KA 5466/08	KA 5467/08	KA 5468/08
0,9 mm	KA 5461/09	KA 5462/09	KA 5463/09	KA 5464/09	KA 5465/09	KA 5466/09	KA 5467/09	KA 5468/09
1,0 mm	KA 5461/10	KA 5462/10	KA 5463/10	KA 5464/10	KA 5465/10	KA 5466/10	KA 5467/10	KA 5468/10
1,2 mm	KA 5461/12	KA 5462/12	KA 5463/12	KA 5464/12	KA 5465/12	KA 5466/12	KA 5467/12	KA 5468/12
1,4 mm	KA 5461/14	KA 5462/14	KA 5463/14	KA 5464/14	KA 5465/14	KA 5466/14	KA 5467/14	KA 5468/14
1,5 mm	KA 5461/15	KA 5462/15	KA 5463/15	KA 5464/15	KA 5465/15	KA 5466/15	KA 5467/15	KA 5468/15
1,6 mm	KA 5461/16	KA 5462/16	KA 5463/16	KA 5464/16	KA 5465/16	KA 5466/16	KA 5467/16	KA 5468/16
1,7 mm	KA 5461/17	KA 5462/17	KA 5463/17	KA 5464/17	KA 5465/17	KA 5466/17	KA 5467/17	KA 5468/17
1,8 mm	KA 5461/18	KA 5462/18	KA 5463/18	KA 5464/18	KA 5465/18	KA 5466/18	KA 5467/18	KA 5468/18
2,0 mm	KA 5461/20	KA 5462/20	KA 5463/20	KA 5464/20	KA 5465/20	KA 5466/20	KA 5467/20	KA 5468/20
2,2 mm	KA 5461/22	KA 5462/22	KA 5463/22	KA 5464/22	KA 5465/22	KA 5466/22	KA 5467/22	KA 5468/22
2,5 mm	KA 5461/25	KA 5462/25	KA 5463/25	KA 5464/25	KA 5465/25	KA 5466/25	KA 5467/25	KA 5468/25
3,0 mm	KA 5461/30	KA 5462/30	KA 5463/30	KA 5464/30	KA 5465/30	KA 5466/30	KA 5467/30	KA 5468/30

ORTHOPÄDIE ORTHOPAEDIC ORTOPEDIA ORTHOPEDIE ORTOPEDIA

Kirschner Bohrdrähte
Kirschner Wires
Agujas Kirschner
Broches de Kirschner
Fili Kirschner



	60 mm	70 mm	80 mm	120 mm	140 mm	160 mm	230 mm	310 mm
0,6 mm	KA 5471/06	KA 5472/06	KA 5473/06	KA 5474/06	KA 5475/06	KA 5476/06	KA 5477/06	KA 5478/06
0,8 mm	KA 5471/08	KA 5472/08	KA 5473/08	KA 5474/08	KA 5475/08	KA 5476/08	KA 5477/08	KA 5478/08
0,9 mm	KA 5471/09	KA 5472/09	KA 5473/09	KA 5474/09	KA 5475/09	KA 5476/09	KA 5477/09	KA 5478/09
1,0 mm	KA 5471/10	KA 5472/10	KA 5473/10	KA 5474/10	KA 5475/10	KA 5476/10	KA 5477/10	KA 5478/10
1,2 mm	KA 5471/12	KA 5472/12	KA 5473/12	KA 5474/12	KA 5475/12	KA 5476/12	KA 5477/12	KA 5478/12
1,4 mm	KA 5471/14	KA 5472/14	KA 5473/14	KA 5474/14	KA 5475/14	KA 5476/14	KA 5477/14	KA 5478/14
1,5 mm	KA 5471/15	KA 5472/15	KA 5473/15	KA 5474/15	KA 5475/15	KA 5476/15	KA 5477/15	KA 5478/15
1,6 mm	KA 5471/16	KA 5472/16	KA 5473/16	KA 5474/16	KA 5475/16	KA 5476/16	KA 5477/16	KA 5478/16
1,7 mm	KA 5471/17	KA 5472/17	KA 5473/17	KA 5474/17	KA 5475/17	KA 5476/17	KA 5477/17	KA 5478/17
1,8 mm	KA 5471/18	KA 5472/18	KA 5473/18	KA 5474/18	KA 5475/18	KA 5476/18	KA 5477/18	KA 5478/18
2,0 mm	KA 5471/20	KA 5472/20	KA 5473/20	KA 5474/20	KA 5475/20	KA 5476/20	KA 5477/20	KA 5478/20
2,2 mm	KA 5471/22	KA 5472/22	KA 5473/22	KA 5474/22	KA 5475/22	KA 5476/22	KA 5477/22	KA 5478/22
2,5 mm	KA 5471/25	KA 5472/25	KA 5473/25	KA 5474/25	KA 5475/25	KA 5476/25	KA 5477/25	KA 5478/25
3,0 mm	KA 5471/30	KA 5472/30	KA 5473/30	KA 5474/30	KA 5475/30	KA 5476/30	KA 5477/30	KA 5478/30

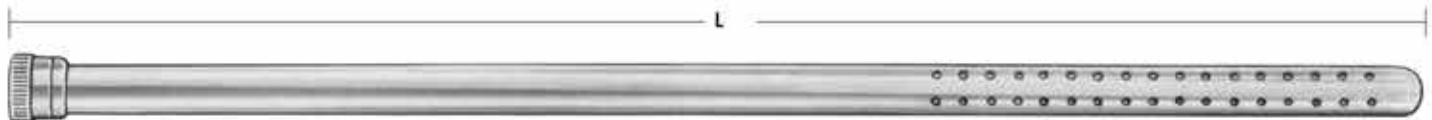

1/1

KIRSCHNER
15,5 cm KA 5540/15
19,0 cm KA 5540/19
32,0 cm KA 5540/32



AA
AB
AC
AD
AE
AF
AK
AL
AM
AO
AP
AR
KA
KD
KU
KY

ORTHOPÄDIE ORTHOPAEDIC ORTOPEDIA ORTHOPEDIE ORTOPEDIA

Knochen-Schrauben
Bone Screws
Tornillos para huesos
Vis d'ostéo-synthèse
Viti per ossa

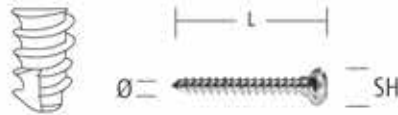
CORTICALIS



	SH 3,0 mm	SH 3,0 mm	SH 4,0 mm	SH 4,0 mm	SH 5,0 mm	SH 5,0 mm
		 TITAN	 TITAN		 TITAN	
L	Ø 1,5 mm	Ø 1,5 mm	Ø 2,0 mm	Ø 2,0 mm	Ø 2,7 mm	Ø 2,7 mm
4 mm	KA 5600/04	KA 5601/04	KA 5602/04	KA 5603/04		
6 mm	KA 5600/06	KA 5601/06	KA 5602/06	KA 5603/06	KA 5604/06	KA 5605/06
7 mm	KA 5600/07	KA 5601/07				
8 mm	KA 5600/08	KA 5601/08	KA 5602/08	KA 5603/08	KA 5604/08	KA 5605/08
9 mm	KA 5600/09	KA 5601/09				
10 mm	KA 5600/10	KA 5601/10	KA 5602/10	KA 5603/10	KA 5604/10	KA 5605/10
11 mm	KA 5600/11	KA 5601/11				
12 mm	KA 5600/12	KA 5601/12	KA 5602/12	KA 5603/12	KA 5604/12	KA
14 mm	KA 5600/14	KA 5601/14	KA 5602/14	KA 5603/14	KA 5604/14	5605/12 KA 5605/14
16 mm	KA 5600/16	KA 5601/16	KA 5602/16	KA 5603/16	KA 5604/16	KA 5605/16
18 mm	KA 5600/18	KA 5601/18	KA 5602/18	KA 5603/18	KA 5604/18	KA 5605/18
20 mm	KA 5600/20	KA 5601/20	KA 5602/20	KA 5603/20	KA 5604/20	KA 5605/20
22 mm			KA 5602/22	KA 5603/22	KA 5604/22	KA 5605/22
24 mm			KA 5602/24	KA 5603/24	KA 5604/24	KA 5605/24
26 mm			KA 5602/26	KA 5603/26	KA 5604/26	KA 5605/26
28 mm			KA 5602/28	KA 5603/28	KA 5604/28	KA 5605/28
30 mm			KA 5602/30	KA 5603/30	KA 5604/30	KA 5605/30
32 mm			KA 5602/32	KA 5603/32	KA 5604/32	KA 5605/32
34 mm			KA 5602/34	KA 5603/34	KA 5604/34	KA 5605/34
36 mm			KA 5602/36	KA 5603/36	KA 5604/36	KA 5605/36
38 mm			KA 5602/38	KA 5603/38	KA 5604/38	KA 5605/38
40 mm					KA 5604/40	KA 5605/40



KA 5690/11

KA 5690/15

KA 5690/20

AA
AB
AC
AD
AE
AF
AK
AL
AM
AO
AP
AR
KA
KD
KU
KY

Knochen-Schrauben
Bone Screws
Tornillos para huesos
Vis d'ostéo-synthèse
Viti per ossa

CORTICALIS



	SH 6,0 mm	SH 6,0 mm	SH 8,0 mm	SH 8,0 mm
		TITAN		TITAN
L	Ø 3,5 mm	Ø 3,5 mm	Ø 4,5 mm	Ø 4,5 mm
10 mm	KA 5606/10	KA 5607/10		
12 mm	KA 5606/12	KA 5607/12		
14 mm	KA 5606/14	KA 5607/14	KA 5608/14	KA 5609/14
16 mm	KA 5606/16	KA 5607/16	KA 5608/16	KA 5609/16
18 mm	KA 5606/18	KA 5607/18	KA 5608/18	KA 5609/18
20 mm	KA 5606/20	KA 5607/20	KA 5608/20	KA 5609/20
22 mm	KA 5606/22	KA 5607/22	KA 5608/22	KA 5609/22
24 mm	KA 5606/24	KA 5607/24	KA 5608/24	KA 5609/24
26 mm	KA 5606/26	KA 5607/26	KA 5608/26	KA 5609/26
28 mm	KA 5606/28	KA 5607/28	KA 5608/28	KA 5609/28
30 mm	KA 5606/30	KA 5607/30	KA 5608/30	KA 5609/30
32 mm	KA 5606/32	KA 5607/32	KA 5608/32	KA 5609/32
34 mm			KA 5608/34	KA 5609/34
36 mm	KA 5606/36	KA 5607/36	KA 5608/36	KA 5609/36
38 mm			KA 5608/38	KA 5609/38
40 mm	KA 5606/40	KA 5607/40	KA 5608/40	KA 5609/40
42 mm			KA 5608/42	KA 5609/42
44 mm			KA 5608/44	KA 5609/44
45 mm	KA 5606/45	KA 5607/45		
46 mm			KA 5608/46	KA 5609/46
48 mm			KA 5608/48	KA 5609/48
50 mm	KA 5606/50	KA 5607/50	KA 5608/50	KA 5609/50
52 mm			KA 5608/52	KA 5609/52
54 mm			KA 5608/54	KA 5609/54
55 mm	KA 5606/55	KA 5607/55		
56 mm			KA 5608/56	KA 5609/56
58 mm			KA 5608/58	KA 5609/58
60 mm	KA 5606/60	KA 5607/60	KA 5608/60	KA 5609/60
62 mm			KA 5608/62	KA 5609/62
64 mm			KA 5608/64	KA 5609/64
65 mm	KA 5606/65	KA 5607/65		
68 mm			KA 5608/68	KA 5609/68
70 mm	KA 5606/70	KA 5607/70	KA 5608/70	KA 5609/70
72 mm			KA 5608/72	KA 5609/72
75 mm	KA 5606/75	KA 5607/75		
76 mm			KA 5608/76	KA 5609/76
80 mm	KA 5606/80	KA 5607/80	KA 5608/80	KA 5609/80
85 mm	KA 5606/85	KA 5607/85	KA 5608/85	KA 5609/85
90 mm	KA 5606/90	KA 5607/90	KA 5608/90	KA 5609/90
95 mm	KA 5606/95	KA 5607/95	KA 5608/95	KA 5609/95
100 mm	KA 5606/96	KA 5607/96	KA 5608/96	KA 5609/96
105 mm	KA 5606/97	KA 5607/97	KA 5608/97	KA 5609/97
110 mm	KA 5606/98	KA 5607/98	KA 5608/98	KA 5609/98



KA 5690/25

KA 5690/32

Knochen-Schrauben
Bone Screws
Tornillos para huesos
Vis d'ostéo-synthèse
Viti per ossa

SPONGIOSA

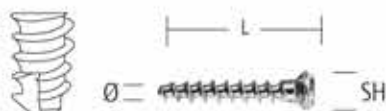

	SH 6,0 mm	SH 6,0 mm
		TITAN
L	Ø 4,0 mm	Ø 4,0 mm
10 mm	KA 5620/10	KA 5621/10
11 mm	KA 5620/11	KA 5621/11
12 mm	KA 5620/12	KA 5621/12
14 mm	KA 5620/14	KA 5621/14
16 mm	KA 5620/16	KA 5621/16
18 mm	KA 5620/18	KA 5621/18
20 mm	KA 5620/20	KA 5621/20
22 mm	KA 5620/22	KA 5621/22
24 mm	KA 5620/24	KA 5621/24
26 mm	KA 5620/26	KA 5621/26
28 mm	KA 5620/28	KA 5621/28
30 mm	KA 5620/30	KA 5621/30
35 mm	KA 5620/35	KA 5621/35
40 mm	KA 5620/40	KA 5621/40
45 mm	KA 5620/45	KA 5621/45
50 mm	KA 5620/50	KA 5621/50
55 mm	KA 5620/55	KA 5621/55
60 mm	KA 5620/60	KA 5621/60

	SH 8,0 mm	SH 8,0 mm
		TITAN
L	Ø 6,5 mm	Ø 6,5 mm
25 mm	KA 5624/25	KA 5625/25
30 mm	KA 5624/30	KA 5625/30
35 mm	KA 5624/35	KA 5625/35
40 mm	KA 5624/40	KA 5625/40
45 mm	KA 5624/45	KA 5625/45
50 mm	KA 5624/50	KA 5625/50
55 mm	KA 5624/55	KA 5625/55
60 mm	KA 5624/60	KA 5625/60
65 mm	KA 5624/65	KA 5625/65
70 mm	KA 5624/70	KA 5625/70
75 mm	KA 5624/75	KA 5625/75
80 mm	KA 5624/80	KA 5625/80
85 mm	KA 5624/85	KA 5625/85
90 mm	KA 5624/90	KA 5625/90
95 mm	KA 5624/95	KA 5625/95
100 mm	KA 5624/96	KA 5625/96
105 mm	KA 5624/97	KA 5625/97
110 mm	KA 5624/98	KA 5625/98



KA 5690/25



KA 5690/32

7 mm



KA 5698/07

13 mm



KA 5698/13

AA
AB
AC
AD
AE
AF
AK
AL
AM
AO
AP
AR
KA
KD
KU
KY

Knochen-Schrauben
 Bone Screws
 Tornillos para huesos
 Vis d'ostéo-synthèse
 Viti per ossa

SPONGIOSA

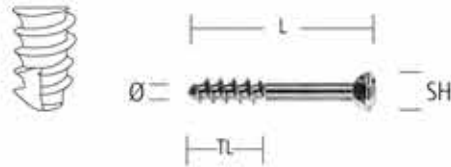

		SH 6,0 mm	SH 6,0 mm
			TITAN
L	TL	Ø 4,0 mm	Ø 4,0 mm
10 mm	5 mm	KA 5630/10	KA 5631/10
12 mm	5 mm	KA 5630/12	KA 5631/12
14 mm	5 mm	KA 5630/14	KA 5631/14
16 mm	6 mm	KA 5630/16	KA 5631/16
18 mm	7 mm	KA 5630/18	KA 5631/18
20 mm	8 mm	KA 5630/20	KA 5631/20
22 mm	9 mm	KA 5630/22	KA 5631/22
24 mm	10 mm	KA 5630/24	KA 5631/24
26 mm	12 mm	KA 5630/26	KA 5631/26
28 mm	14 mm	KA 5630/28	KA 5631/28
30 mm	14 mm	KA 5630/30	KA 5631/30
35 mm	14 mm	KA 5630/35	KA 5631/35
40 mm	14 mm	KA 5630/40	KA 5631/40
45 mm	15 mm	KA 5630/45	KA 5631/45
50 mm	15 mm	KA 5630/50	KA 5631/50



KA 5690/25

7 mm



KA 5698/07

Knochen-Schrauben
Bone Screws
Tornillos para huesos
Vis d'ostéo-synthèse
Viti per ossa

SPONGIOSA

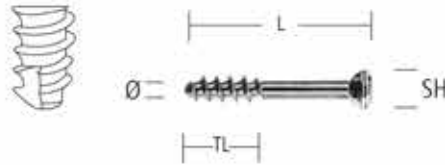

		SH 8,0 mm	SH 8,0 mm			SH 8,0 mm	SH 8,0 mm
			TITAN				TITAN
L	TL	Ø 6,5 mm	Ø 6,5 mm	TL	Ø 6,5 mm	Ø 6,5 mm	
30 mm	16 mm	KA 5632/30	KA 5633/30				
35 mm	16 mm	KA 5632/35	KA 5633/35				
40 mm	16 mm	KA 5632/40	KA 5633/40				
45 mm	16 mm	KA 5632/45	KA 5633/45				
50 mm	16 mm	KA 5632/50	KA 5633/50				
55 mm	16 mm	KA 5632/55	KA 5633/55				
60 mm	16 mm	KA 5632/60	KA 5633/60				
65 mm	16 mm	KA 5632/65	KA 5633/65				
70 mm	16 mm	KA 5632/70	KA 5633/70				
75 mm	16 mm	KA 5632/75	KA 5633/75				
80 mm	16 mm	KA 5632/80	KA 5633/80				
85 mm	16 mm	KA 5632/85	KA 5633/85				
90 mm	16 mm	KA 5632/90	KA 5633/90				
95 mm	16 mm	KA 5632/95	KA 5633/95				
100 mm	16 mm	KA 5632/96	KA 5633/96				
105 mm	16 mm	KA 5632/97	KA 5633/97				
110 mm	16 mm	KA 5632/98	KA 5633/98				
				32 mm	KA 5634/45	KA 5635/45	
				32 mm	KA 5634/50	KA 5635/50	
				32 mm	KA 5634/55	KA 5635/55	
				32 mm	KA 5634/60	KA 5635/60	
				32 mm	KA 5634/65	KA 5635/65	
				32 mm	KA 5634/70	KA 5635/70	
				32 mm	KA 5634/75	KA 5635/75	
				32 mm	KA 5634/80	KA 5635/80	
				32 mm	KA 5634/85	KA 5635/85	
				32 mm	KA 5634/90	KA 5635/90	
				32 mm	KA 5634/95	KA 5635/95	
				32 mm	KA 5634/96	KA 5635/96	
				32 mm	KA 5634/97	KA 5635/97	
				32 mm	KA 5634/98	KA 5635/98	



KA 5690/32

KA 5690/32

13 mm



KA 5698/13

KA 5698/13

AA
AB
AC
AD
AE
AF
AK
AL
AM
AO
AP
AR
KA
KD
KU
KY

Knochen-Schrauben
Bone Screws
Tornillos para huesos
Vis d'ostéo-synthèse
Viti per ossa

selbstschneidend
self-cutting
rosca cortante
auto-taraudeuses
filetto tagliante

**CORTICALIS
CANNULATED**



	SH 6,0 mm	SH 8,0 mm
	C 1,6 mm	C 1,8 mm
	TITAN	TITAN
L	Ø 3,5 mm	Ø 4,5 mm
12 mm	KA 5640/12	
14 mm	KA 5640/14	
16 mm	KA 5640/16	
18 mm	KA 5640/18	
20 mm	KA 5640/20	
22 mm	KA 5640/22	
24 mm	KA 5640/24	
26 mm	KA 5640/26	
28 mm	KA 5640/28	
30 mm	KA 5640/30	KA 5642/30
32 mm	KA 5640/32	KA 5642/32
34 mm	KA 5640/34	KA 5642/34
36 mm	KA 5640/36	KA 5642/36
38 mm	KA 5640/38	KA 5642/38
40 mm	KA 5640/40	KA 5642/40
42 mm	KA 5640/42	KA 5642/42
44 mm	KA 5640/44	KA 5642/44
46 mm	KA 5640/46	KA 5642/46
48 mm	KA 5640/48	KA 5642/48
52 mm	KA 5640/52	
57 mm	KA 5640/57	KA 5642/57
62 mm	KA 5640/62	KA 5642/62
67 mm	KA 5640/67	KA 5642/67
72 mm	KA 5640/72	KA 5642/72



KA 5690/25 KA 5690/32

**CORTICALIS
CANNULATED**

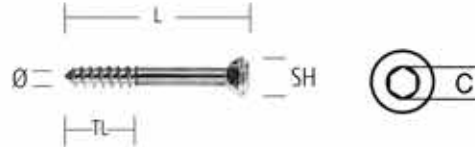

		SH 6,0 mm	SH 8,0 mm
		C 1,6 mm	C 1,8 mm
		TITAN	TITAN
L	TL	Ø 4,0 mm	Ø 4,5 mm
30 mm	20 mm	KA 5644/30	KA 5646/30
32 mm	20 mm	KA 5644/32	KA 5646/32
34 mm	20 mm	KA 5644/34	KA 5646/34
35 mm	20 mm		
40 mm	20 mm	KA 5644/40	KA 5646/40
42 mm	20 mm	KA 5644/42	KA 5646/42
44 mm	20 mm	KA 5644/44	KA 5646/44
45 mm	20 mm		
46 mm	20 mm	KA 5644/46	KA 5646/46
48 mm	20 mm	KA 5644/48	KA 5646/48
50 mm	20 mm	KA 5644/50	KA 5646/50
55 mm	20 mm	KA 5644/55	KA 5646/55
60 mm	20 mm	KA 5644/60	KA 5646/60
65 mm	20 mm	KA 5644/65	KA 5646/65
70 mm	20 mm	KA 5644/70	KA 5646/70



KA 5690/25 KA 5690/32

Knochen-Schrauben
Bone Screws
Tornillos para huesos
Vis d'ostéo-synthèse
Viti per ossa

selbstschneidend
self-cutting
rosca cortante
auto-taraudeuses
filetto tagliante

**SPONGIOSA
CANNULATED**



		SH 8,0 mm
		C 2,0 mm
		TITAN
L	TL	Ø 5,0 mm
30 mm	20 mm	KA 5648/30
32 mm	20 mm	KA 5648/32
34 mm	20 mm	KA 5648/34
40 mm	20 mm	KA 5648/40
42 mm	20 mm	KA 5648/42
44 mm	20 mm	KA 5648/44
46 mm	20 mm	KA 5648/46
48 mm	20 mm	KA 5648/48
50 mm	20 mm	KA 5648/50
55 mm	20 mm	KA 5648/55
60 mm	20 mm	KA 5648/60
65 mm	20 mm	KA 5648/65
70 mm	20 mm	KA 5648/70

		SH 8,0 mm
		C 3,2 mm
		TITAN
L	TL	Ø 6,5 mm
35 mm	25 mm	KA 5649/35
40 mm	25 mm	KA 5649/40
45 mm	25 mm	KA 5649/45
50 mm	25 mm	KA 5649/50
55 mm	25 mm	KA 5649/55
60 mm	25 mm	KA 5649/60
65 mm	25 mm	KA 5649/65
70 mm	25 mm	KA 5649/70
75 mm	25 mm	KA 5649/75
80 mm	25 mm	KA 5649/80
85 mm	25 mm	KA 5649/85
90 mm	25 mm	KA 5649/90
95 mm	25 mm	KA 5649/95
100 mm	25 mm	KA 5650/01
105 mm	25 mm	KA 5650/02
110 mm	25 mm	KA 5650/03
115 mm	25 mm	KA 5650/04
120 mm	25 mm	KA 5650/05
125 mm	25 mm	KA 5650/06
130 mm	25 mm	KA 5650/07



KA 5690/32

13 mm



KA 5698/13



KA 5690/25

13 mm



KA 5698/13

AA
AB
AC
AD
AE
AF
AK
AL
AM
AO
AP
AR
KA
KD
KU
KY

Knochen-Schrauben
 Bone Screws
 Tornillos para huesos
 Vis d'ostéo-synthèse
 Viti per ossa

MALLEOLAR

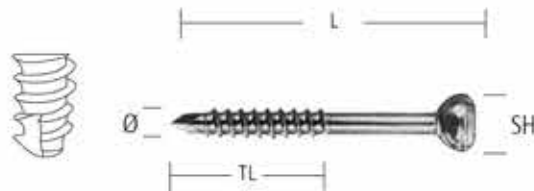

		SH 8,0 mm	SH 8,0 mm
			TITAN
L	TL	Ø 4,5 mm	Ø 4,5 mm
30 mm	15 mm	KA 5655/30	KA 5656/30
35 mm	18 mm	KA 5655/35	KA 5656/35
40 mm	20 mm	KA 5655/40	KA 5656/40
45 mm	22 mm	KA 5655/45	KA 5656/45
50 mm	24 mm	KA 5655/50	KA 5656/50
55 mm	26 mm	KA 5655/55	KA 5656/55
60 mm	28 mm	KA 5655/60	KA 5656/60
65 mm	30 mm	KA 5655/65	KA 5656/65
70 mm	32 mm	KA 5655/70	KA 5656/70



KA 5690/32

Vorbohrer für Knochen-Schrauben
 Drill Bit for Bone Screws
 Broca para tornillos para huesos
 Aléssoir pour Vis d'ostéo-synthèse
 Alesatore per Viti per ossa



Ø	L	
1,1 mm	52 mm	KA 5690/11
1,5 mm	100 mm	KA 5690/15
2,0 mm	100 mm	KA 5690/20
2,5 mm	111 mm	KA 5690/25
3,2 mm	130 mm	KA 5690/32

AA

AB

AC

AD

AE

AF

AK

AL

AM

AO

AP

AR

KA

KD

KU

KY

DARM, MAGEN
INTESTINES, STOMACH
INTESTINOS, ESTOMAGO
INTESTINS, ESTOMAC
INTESTINI, STOMACO

KD

nopa[®] instruments





Gewebefasszängchen, Darmfasszangen
 Tissue Seizing Forceps
 Pinzas para coger tejidos e intestinos
 Pincers pour saisir le tissu et l'intestin
 Pinze per afferrare tessuti e l'intestino

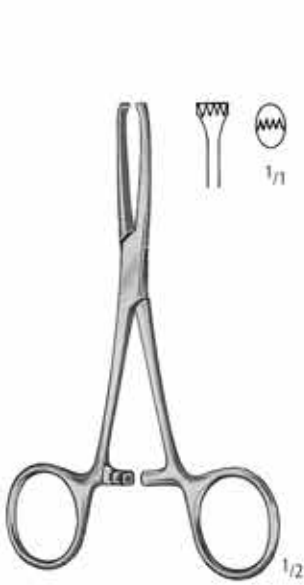

ALLIS-BABY 4:5
KD 050/12
 12,5 cm/5"



ALLIS 4:5
KD 054/15
 15,0 cm/6"



ALLIS 5:6
 15,0 cm/6" **KD 055/15**
 19,0 cm/7 1/2" **KD 055/19**
 25,0 cm/10" **KD 055/25**
 36,0 cm/14" **KD 055/36**



ALLIS

KD 058/16
 16,0 cm/6 1/4"

KD 058/20
 20,0 cm/8"

KD 058/25
 25,0 cm/10"

KD 058/30
 30,0 cm/12"



ALLIS-ADAIR 10:11
KD 060/15
 15,0 cm/6"

AA
AB
AC
AD
AE
AF
AK
AL
AM
AO
AP
AR
KA
KD
KU
KY

Gewebefasszängchen, Darmfasszangen
 Tissue Seizing Forceps
 Pinzas para coger tejidos e intestinos
 Pincers pour saisir le tissu et l'intestin
 Pinze per afferrare tessuti e l'intestino

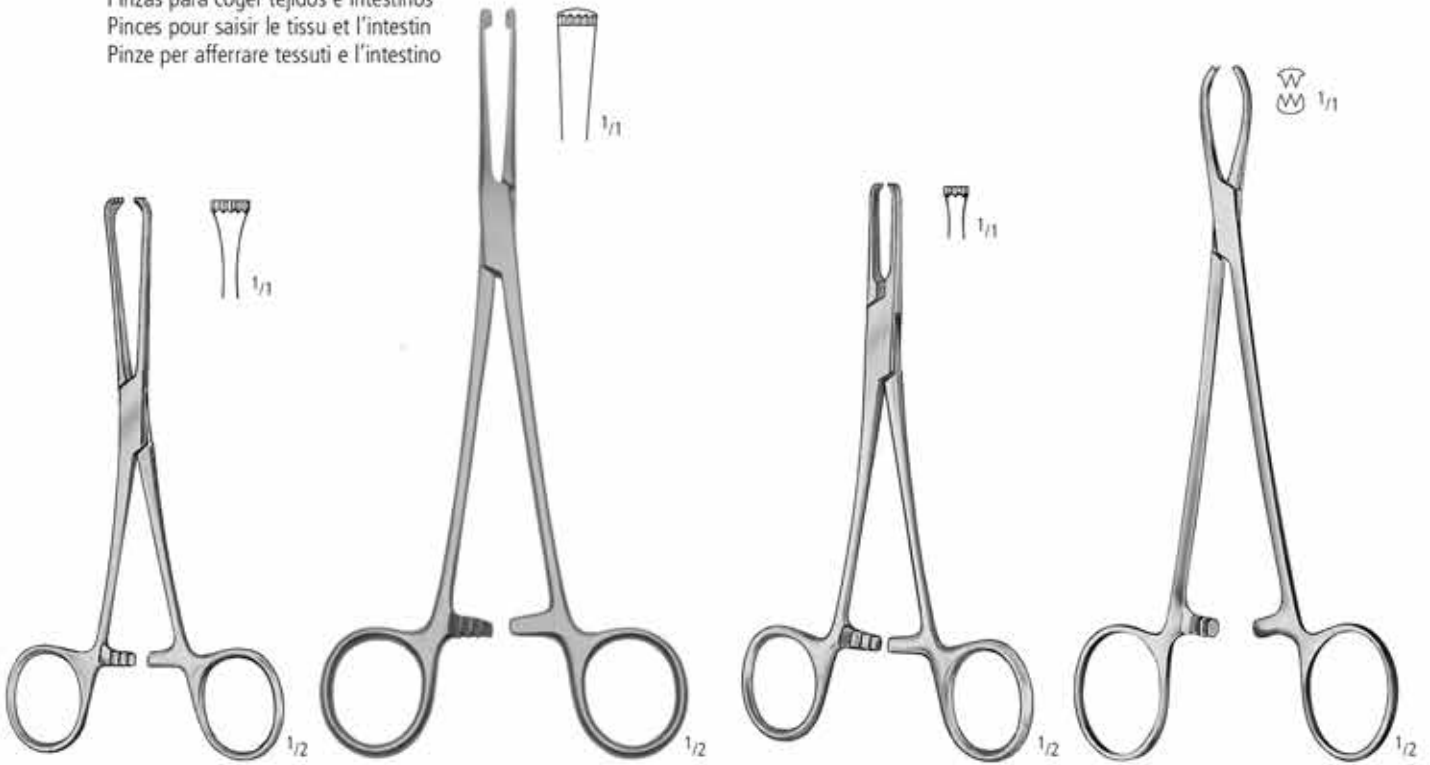

BOYS-ALLIS 5:6
KD 065/15
 15,0 cm/6"

LOCKWOOD-ALLIS 5:6
KD 067/20
 20,0 cm/8"

JUDD-ALLIS 3:4
 15,0 cm/6" **KD 070/15**
 19,0 cm/7½" **KD 070/19**

LITTLEWOOD
KD 075/18
 18,0 cm/7"

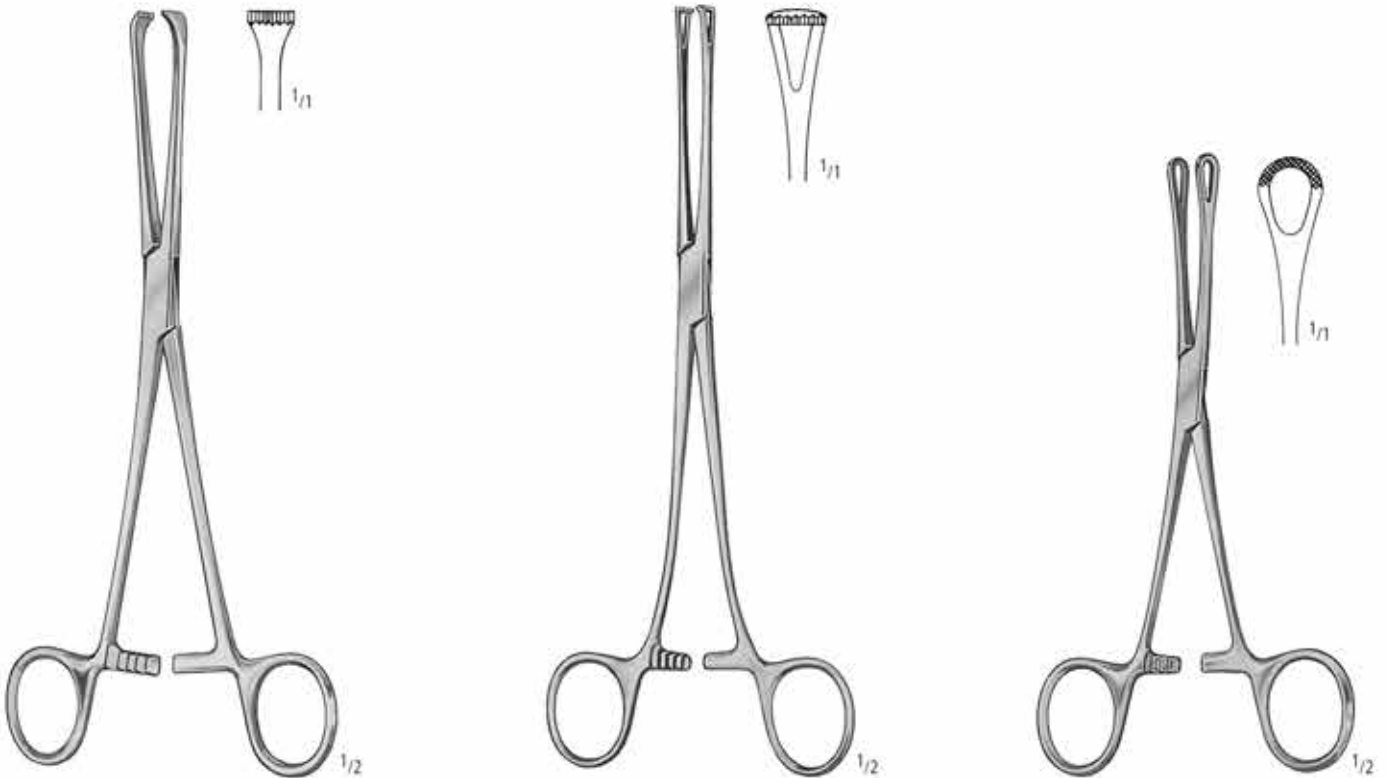

THOMS-ALLIS 6:7
KD 080/20
 20,0 cm/8"

LOCKWOOD
KD 085/20
 20,0 cm/8"

WILLIAMS
KD 090/16
 16,0 cm/6¼"

Darmfasszangen
 Intestinal Tissue Forceps
 Pinzas para coger intestinos
 Pincas pour saisir l'intestin
 Pinze per afferrare l'intestino

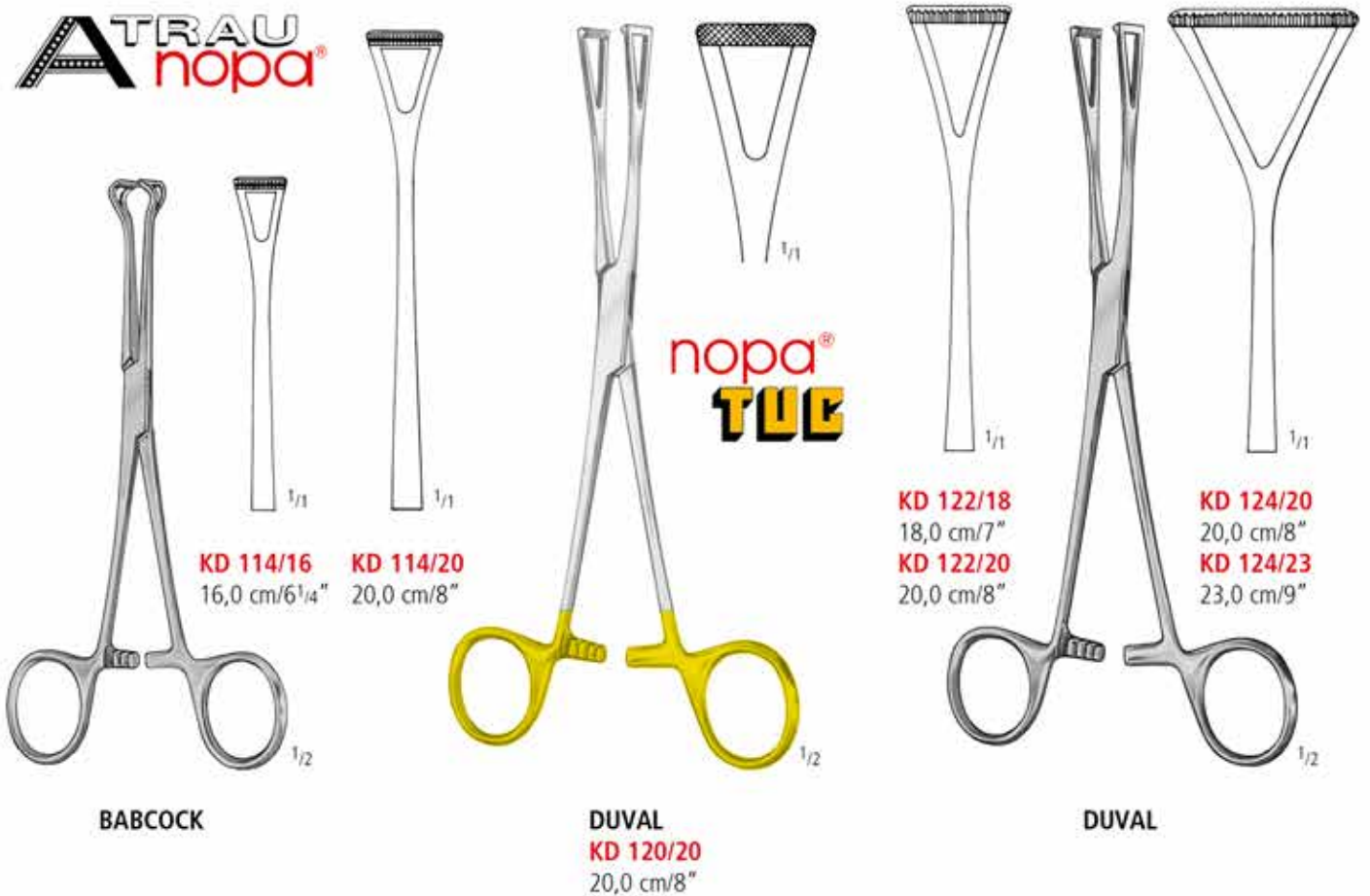
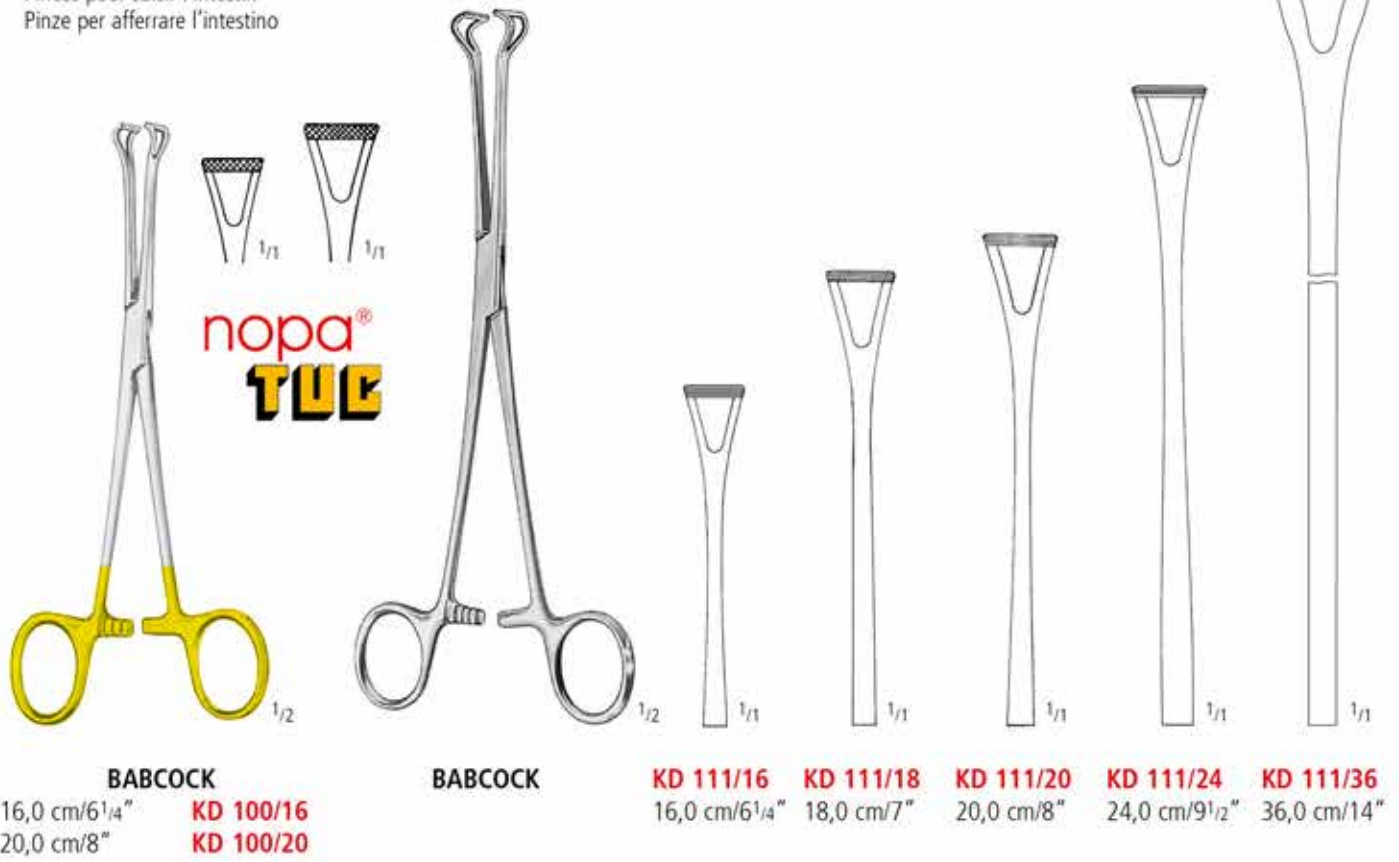

AA
 AB
 AC
 AD
 AE
 AF
 AG
 AH
 AI
 AJ
 AK
 AL
 AM
 AN
 AO
 AP
 AQ
 AR
 AS
 AT
 AU
 AV
 AW
 AX
 AY
 AZ

KD

Magen- und Darmklemmen
 Stomach and Intestinal Clamp Forceps
 Pinzas-clamps estomacales e intestinales
 Pincés-clamps stomacales et pour l'intestin
 Pinze stomacali e intestinali

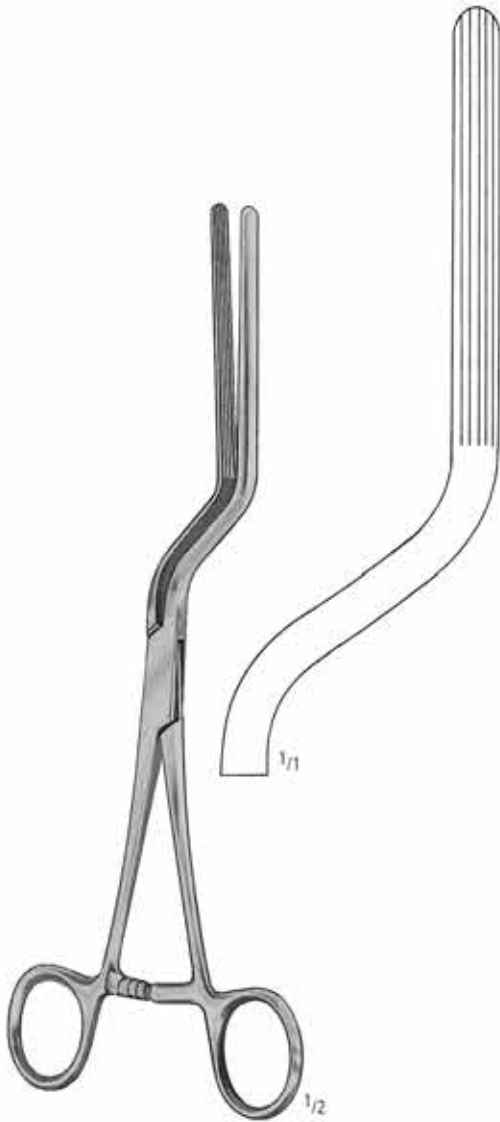

BRUNNER
KD 180/24
 24,0 cm/9¹/₂"

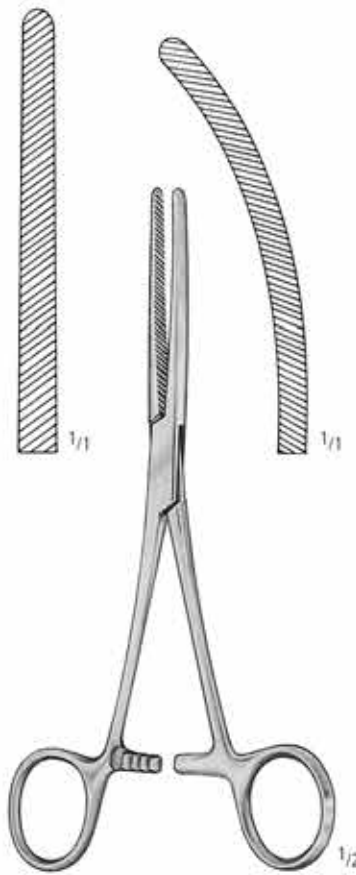

BABY-DOYEN
KD 190/16 16,5 cm/6¹/₂" **KD 191/16**
KD 190/18 18,0 cm/7" **KD 191/18**

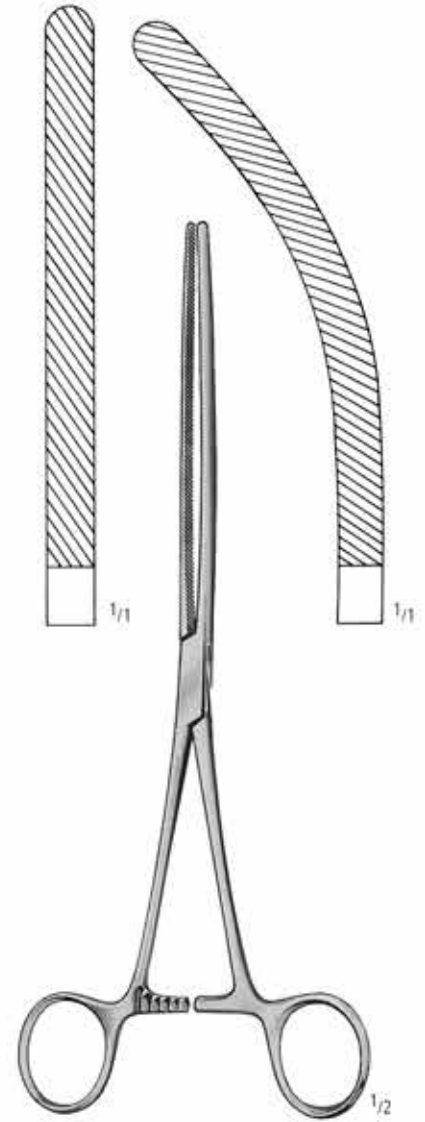

DOYEN
KD 200/21 21,0 cm/8¹/₄" **KD 201/21**
KD 200/23 23,0 cm/9" **KD 201/23**

Magen- und Darmklemmen
 Stomach and Intestinal Clamp Forceps
 Pinzas-clamps estomacales e intestinales
 Pincas-clamps stomacales et pour l'intestin
 Pinze stomacali e intestinali

AA
AB
AC
AD
AE
AF
AK
AL
AM
AO
AP
AR
KA
KU
KY

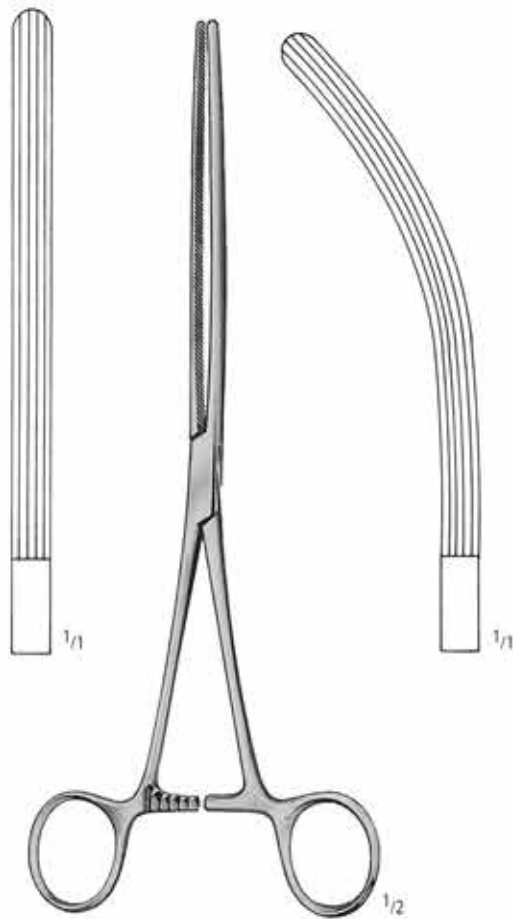

MAYO-ROBSON

- KD 210/21** 21,0 cm/8¹/₄" **KD 211/21**
- KD 210/23** 23,0 cm/9" **KD 211/23**
- KD 210/25** 25,0 cm/10" **KD 211/25**

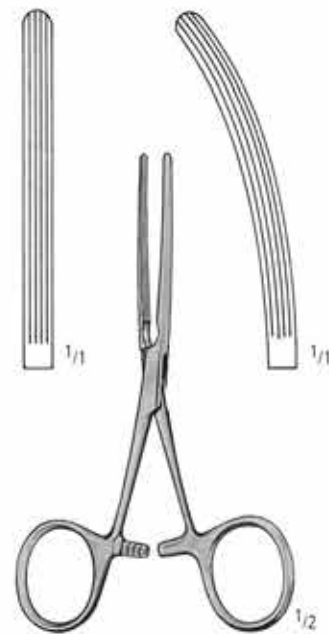

BABY-KOCHER

- KD 212/13** 13,0 cm/5" **KD 213/13**

KD

Magen- und Darmklemmen
 Stomach and Intestinal Clamp Forceps
 Pinzas-clamps estomacales e intestinales
 Pincas-clamps stomacales et pour l'intestin
 Pinze stomacali e intestinali

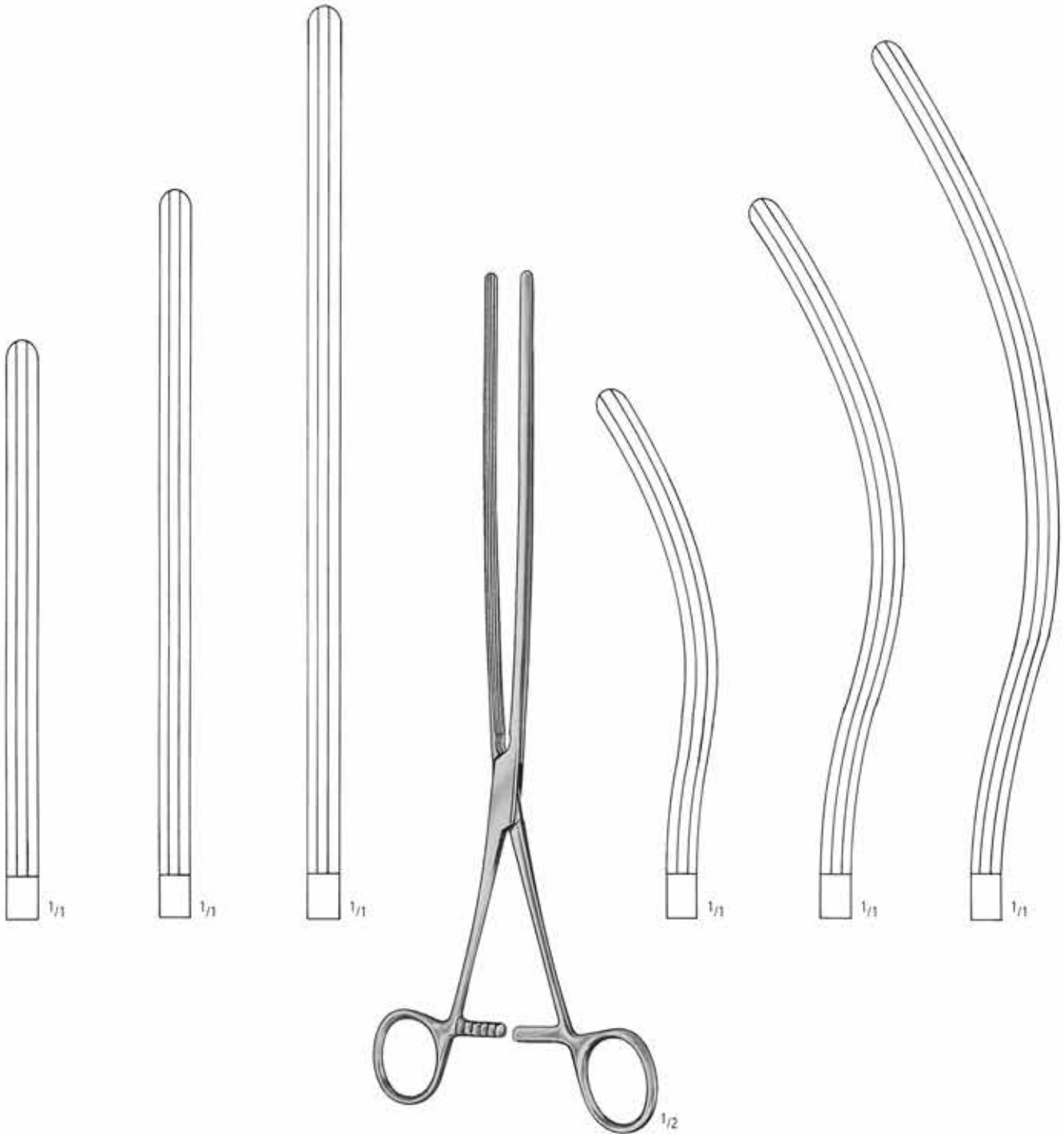

KOCHER

- | | | |
|------------------|---|------------------|
| KD 214/22 | 22,0 cm/8 ³ / ₄ " | KD 215/22 |
| KD 214/25 | 25,0 cm/10" | KD 215/25 |
| KD 214/28 | 28,0 cm/11" | KD 215/28 |

sehr elastisch - very elastic - muy elásticas - très élastiques - molto elastiche

Magen- und Darmklemmen
 Stomach and Intestinal Clamp Forceps
 Pinzas-clamps estomacales e intestinales
 Pincas-clamps stomacales et pour l'intestin
 Pinze stomacali e intestinali

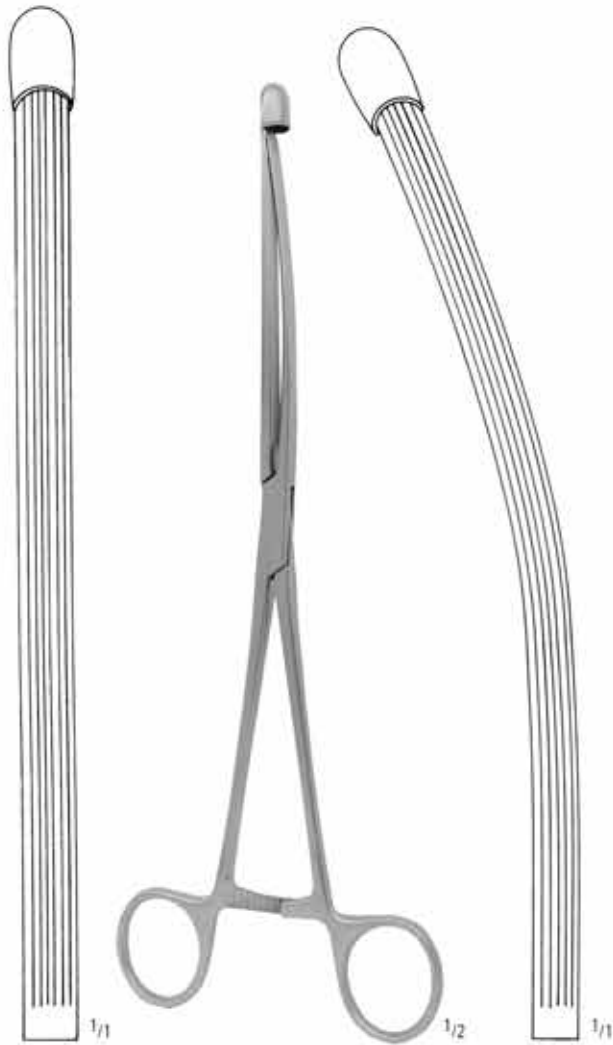

KD 224/25

NUSSBAUM
 25,0 cm/10"

KD 225/25

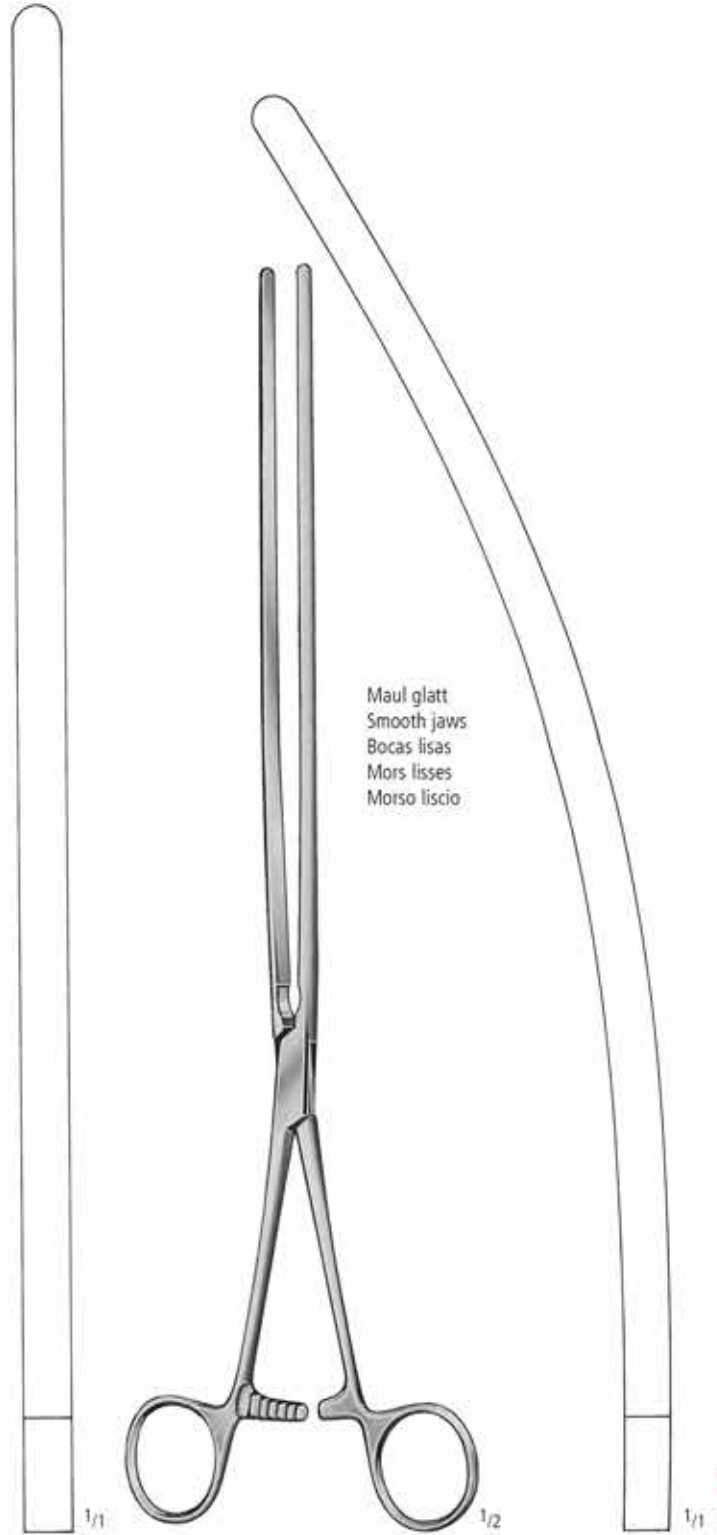

KD 230/25
KD 230/33

SCUDDER
 25,0 cm/10"
 33,0 cm/13"

KD 231/25
KD 231/33

Maul glatt
 Smooth jaws
 Bocas lisas
 Mors lisses
 Morso liscio

AA
 AB
 AC
 AD
 AE
 AF
 AG
 AH
 AI
 AJ
 AK
 AL
 AM
 AN
 AO
 AP
 AQ
 AR
 AS
 AT
 AU
 AV
 AW
 AX
 AY
 AZ
 BA
 BB
 BC
 BD
 BE
 BF
 BG
 BH
 BI
 BJ
 BK
 BL
 BM
 BN
 BO
 BP
 BQ
 BR
 BS
 BT
 BU
 BV
 BW
 BX
 BY
 BZ
 CA
 CB
 CC
 CD
 CE
 CF
 CG
 CH
 CI
 CJ
 CK
 CL
 CM
 CN
 CO
 CP
 CQ
 CR
 CS
 CT
 CU
 CV
 CW
 CX
 CY
 CZ
 DA
 DB
 DC
 DD
 DE
 DF
 DG
 DH
 DI
 DJ
 DK
 DL
 DM
 DN
 DO
 DP
 DQ
 DR
 DS
 DT
 DU
 DV
 DW
 DX
 DY
 DZ
 EA
 EB
 EC
 ED
 EE
 EF
 EG
 EH
 EI
 EJ
 EK
 EL
 EM
 EN
 EO
 EP
 EQ
 ER
 ES
 ET
 EU
 EV
 EW
 EX
 EY
 EZ
 FA
 FB
 FC
 FD
 FE
 FF
 FG
 FH
 FI
 FJ
 FK
 FL
 FM
 FN
 FO
 FP
 FQ
 FR
 FS
 FT
 FU
 FV
 FW
 FX
 FY
 FZ
 GA
 GB
 GC
 GD
 GE
 GF
 GG
 GH
 GI
 GJ
 GK
 GL
 GM
 GN
 GO
 GP
 GQ
 GR
 GS
 GT
 GU
 GV
 GW
 GX
 GY
 GZ
 HA
 HB
 HC
 HD
 HE
 HF
 HG
 HH
 HI
 HJ
 HK
 HL
 HM
 HN
 HO
 HP
 HQ
 HR
 HS
 HT
 HU
 HV
 HW
 HX
 HY
 HZ
 IA
 IB
 IC
 ID
 IE
 IF
 IG
 IH
 II
 IJ
 IK
 IL
 IM
 IN
 IO
 IP
 IQ
 IR
 IS
 IT
 IU
 IV
 IW
 IX
 IY
 IZ
 JA
 JB
 JC
 JD
 JE
 JF
 JG
 JH
 JI
 JJ
 JK
 JL
 JM
 JN
 JO
 JP
 JQ
 JR
 JS
 JT
 JU
 JV
 JW
 JX
 JY
 JZ
 KA
 KB
 KC
 KD
 KE
 KF
 KG
 KH
 KI
 KJ
 KK
 KL
 KM
 KN
 KO
 KP
 KQ
 KR
 KS
 KT
 KU
 KV
 KW
 KX
 KY
 KZ
 LA
 LB
 LC
 LD
 LE
 LF
 LG
 LH
 LI
 LJ
 LK
 LL
 LM
 LN
 LO
 LP
 LQ
 LR
 LS
 LT
 LU
 LV
 LW
 LX
 LY
 LZ
 MA
 MB
 MC
 MD
 ME
 MF
 MG
 MH
 MI
 MJ
 MK
 ML
 MM
 MN
 MO
 MP
 MQ
 MR
 MS
 MT
 MU
 MV
 MW
 MX
 MY
 MZ
 NA
 NB
 NC
 ND
 NE
 NF
 NG
 NH
 NI
 NJ
 NK
 NL
 NM
 NN
 NO
 NP
 NQ
 NR
 NS
 NT
 NU
 NV
 NW
 NX
 NY
 NZ
 OA
 OB
 OC
 OD
 OE
 OF
 OG
 OH
 OI
 OJ
 OK
 OL
 OM
 ON
 OO
 OP
 OQ
 OR
 OS
 OT
 OU
 OV
 OW
 OX
 OY
 OZ
 PA
 PB
 PC
 PD
 PE
 PF
 PG
 PH
 PI
 PJ
 PK
 PL
 PM
 PN
 PO
 PP
 PQ
 PR
 PS
 PT
 PU
 PV
 PW
 PX
 PY
 PZ
 QA
 QB
 QC
 QD
 QE
 QF
 QG
 QH
 QI
 QJ
 QK
 QL
 QM
 QN
 QO
 QP
 QQ
 QR
 QS
 QT
 QU
 QV
 QW
 QX
 QY
 QZ
 RA
 RB
 RC
 RD
 RE
 RF
 RG
 RH
 RI
 RJ
 RK
 RL
 RM
 RN
 RO
 RP
 RQ
 RR
 RS
 RT
 RU
 RV
 RW
 RX
 RY
 RZ
 SA
 SB
 SC
 SD
 SE
 SF
 SG
 SH
 SI
 SJ
 SK
 SL
 SM
 SN
 SO
 SP
 SQ
 SR
 SS
 ST
 SU
 SV
 SW
 SX
 SY
 SZ
 TA
 TB
 TC
 TD
 TE
 TF
 TG
 TH
 TI
 TJ
 TK
 TL
 TM
 TN
 TO
 TP
 TQ
 TR
 TS
 TT
 TU
 TV
 TW
 TX
 TY
 TZ
 UA
 UB
 UC
 UD
 UE
 UF
 UG
 UH
 UI
 UJ
 UK
 UL
 UM
 UN
 UO
 UP
 UQ
 UR
 US
 UT
 UY
 UZ
 VA
 VB
 VC
 VD
 VE
 VF
 VG
 VH
 VI
 VJ
 VK
 VL
 VM
 VN
 VO
 VP
 VQ
 VR
 VS
 VT
 VY
 VZ
 WA
 WB
 WC
 WD
 WE
 WF
 WG
 WH
 WI
 WJ
 WK
 WL
 WM
 WN
 WO
 WP
 WQ
 WR
 WS
 WT
 WY
 WZ
 XA
 XB
 XC
 XD
 XE
 XF
 XG
 XH
 XI
 XJ
 XK
 XL
 XM
 XN
 XO
 XP
 XQ
 XR
 XS
 XT
 XU
 XV
 XW
 XX
 XY
 XZ
 YA
 YB
 YC
 YD
 YE
 YF
 YG
 YH
 YI
 YJ
 YK
 YL
 YM
 YN
 YO
 YP
 YQ
 YR
 YS
 YT
 YZ
 ZA
 ZB
 ZC
 ZD
 ZE
 ZF
 ZG
 ZH
 ZI
 ZJ
 ZK
 ZL
 ZM
 ZN
 ZO
 ZP
 ZQ
 ZR
 ZS
 ZT
 ZY
 ZZ

Atraumatische Magen- und Darmklemmen
 Non-traumatic Stomach and Intestinal Clamp Forceps
 Pinzas-clamps estomacales e intestinales Atrauma
 Pincers-clamps stomacales et pour l'intestin Atrauma
 Pinze stomacali e intestinali Atrauma

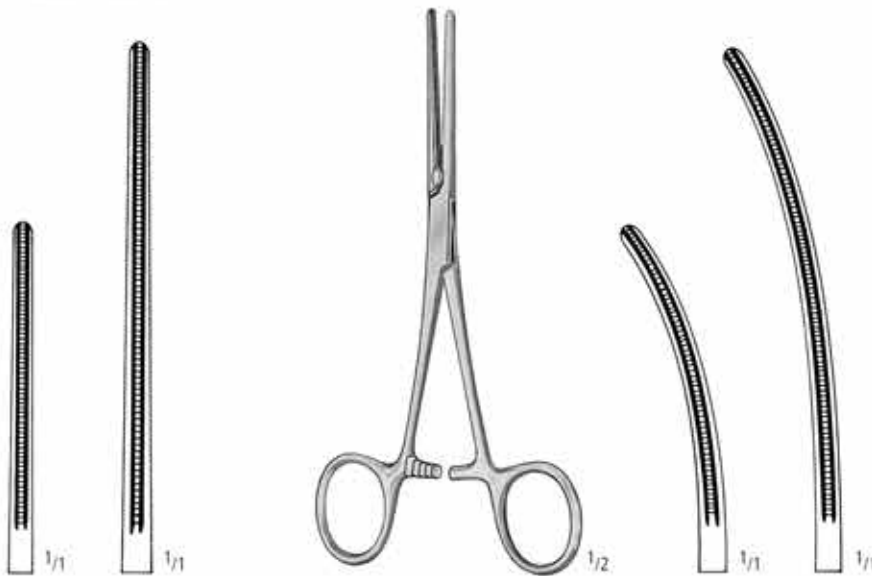

BAINBRIDGE

- | | | |
|------------------|------------|------------------|
| KD 234/15 | 15,0 cm/6" | KD 235/15 |
| KD 234/18 | 18,0 cm/7" | KD 235/18 |



DOYEN

- | | | |
|------------------|---|------------------|
| KD 240/16 | 16,0 cm/6 ¹ / ₄ " | KD 241/16 |
| KD 240/18 | 18,0 cm/7" | KD 241/18 |
| KD 240/21 | 21,0 cm/8 ¹ / ₄ " | KD 241/21 |
| KD 240/23 | 23,0 cm/9" | KD 241/23 |

Atraumatische Magen- und Darmklemmen
 Non-traumatic Stomach and Intestinal Clamp Forceps
 Pinzas-clamps estomacales e intestinales Atrauma
 Pincas-clamps stomacales et pour l'intestin Atrauma
 Pinze stomacali e intestinali Atrauma

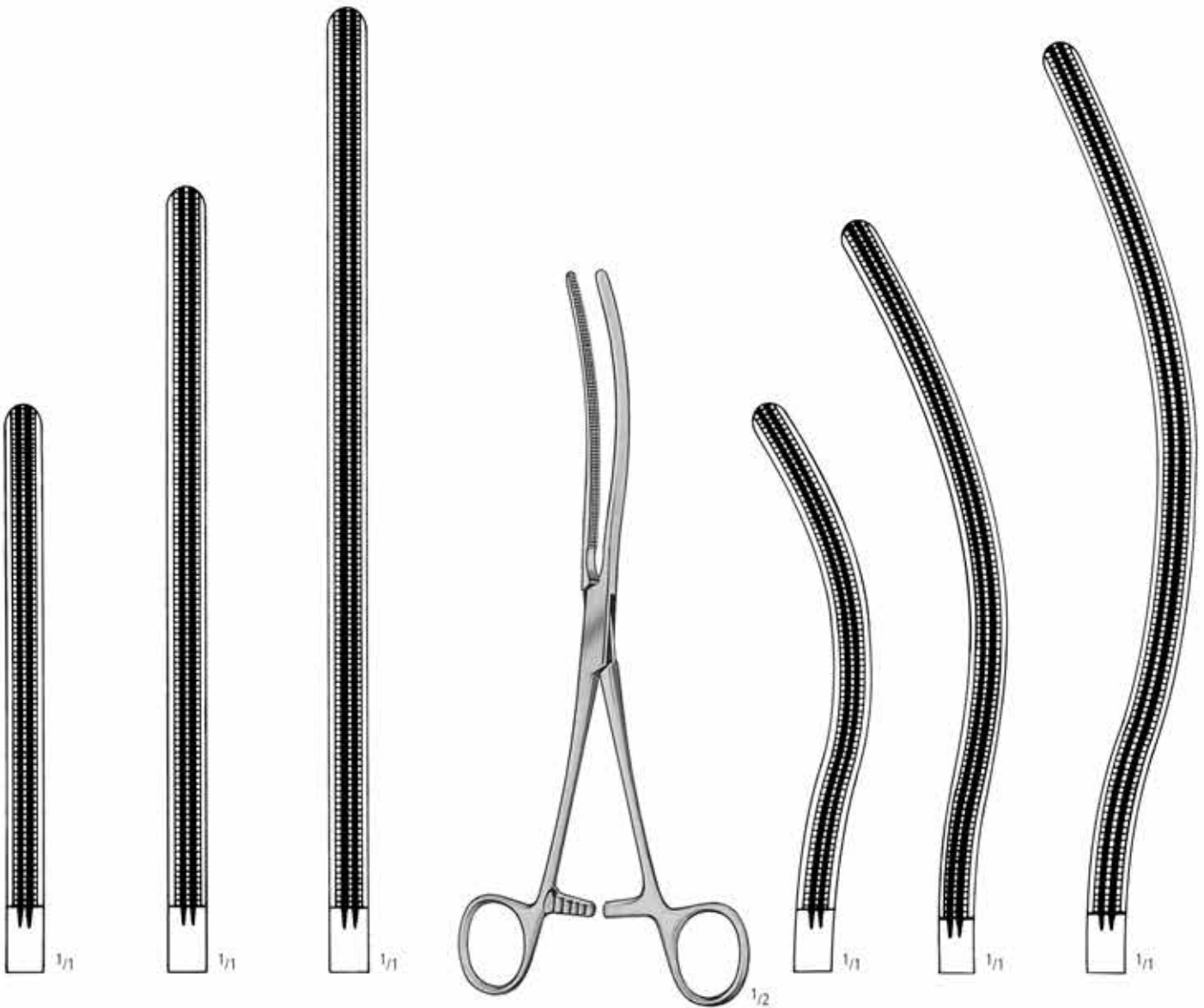

KOCHER

- | | | |
|------------------|---|------------------|
| KD 250/22 | 22,0 cm/8 ³ / ₄ " | KD 251/22 |
| KD 250/25 | 25,0 cm/10" | KD 251/25 |
| KD 250/28 | 28,0 cm/11" | KD 251/28 |

AA
AB
AC
AD
AE
AF
AG
AH
AI
AJ
AK
AL
AM
AN
AO
AP
AQ
AR
AS
AT
AU
AV
AW
AX
AY
AZ
BA
BB
BC
BD
BE
BF
BG
BH
BI
BJ
BK
BL
BM
BN
BO
BP
BQ
BR
BS
BT
BU
BV
BW
BX
BY
BZ
CA
CB
CC
CD
CE
CF
CG
CH
CI
CJ
CK
CL
CM
CN
CO
CP
CQ
CR
CS
CT
CU
CV
CW
CX
CY
CZ
DA
DB
DC
DD
DE
DF
DG
DH
DI
DJ
DK
DL
DM
DN
DO
DP
DQ
DR
DS
DT
DU
DV
DW
DX
DY
DZ
EA
EB
EC
ED
EE
EF
EG
EH
EI
EJ
EK
EL
EM
EN
EO
EP
EQ
ER
ES
ET
EU
EV
EW
EX
EY
EZ
FA
FB
FC
FD
FE
FF
FG
FH
FI
FJ
FK
FL
FM
FN
FO
FP
FQ
FR
FS
FT
FU
FV
FW
FX
FY
FZ
GA
GB
GC
GD
GE
GF
GG
GH
GI
GJ
GK
GL
GM
GN
GO
GP
GQ
GR
GS
GT
GU
GV
GW
GX
GY
GZ
HA
HB
HC
HD
HE
HF
HG
HH
HI
HJ
HK
HL
HM
HN
HO
HP
HQ
HR
HS
HT
HU
HV
HW
HX
HY
HZ
IA
IB
IC
ID
IE
IF
IG
IH
II
IJ
IK
IL
IM
IN
IO
IP
IQ
IR
IS
IT
IU
IV
IW
IX
IY
IZ
JA
JB
JC
JD
JE
JF
JG
JH
JI
JJ
JK
JL
JM
JN
JO
JP
JQ
JR
JS
JT
JU
JV
JW
JX
JY
JZ
KA
KB
KC
KD
KE
KF
KG
KH
KI
KJ
KK
KL
KM
KN
KO
KP
KQ
KR
KS
KT
KU
KV
KW
KX
KY
KZ
LA
LB
LC
LD
LE
LF
LG
LH
LI
LJ
LK
LL
LM
LN
LO
LP
LQ
LR
LS
LT
LU
LV
LW
LX
LY
LZ
MA
MB
MC
MD
ME
MF
MG
MH
MI
MJ
MK
ML
MM
MN
MO
MP
MQ
MR
MS
MT
MU
MV
MW
MX
MY
MZ
NA
NB
NC
ND
NE
NF
NG
NH
NI
NJ
NK
NL
NM
NN
NO
NP
NQ
NR
NS
NT
NU
NV
NW
NX
NY
NZ
OA
OB
OC
OD
OE
OF
OG
OH
OI
OJ
OK
OL
OM
ON
OO
OP
OQ
OR
OS
OT
OU
OV
OW
OX
OY
OZ
PA
PB
PC
PD
PE
PF
PG
PH
PI
PJ
PK
PL
PM
PN
PO
PP
PQ
PR
PS
PT
PU
PV
PW
PX
PY
PZ
QA
QB
QC
QD
QE
QF
QG
QH
QI
QJ
QK
QL
QM
QN
QO
QP
QQ
QR
QS
QT
QU
QV
QW
QX
QY
QZ
RA
RB
RC
RD
RE
RF
RG
RH
RI
RJ
RK
RL
RM
RN
RO
RP
RQ
RR
RS
RT
RU
RV
RW
RX
RY
RZ
SA
SB
SC
SD
SE
SF
SG
SH
SI
SJ
SK
SL
SM
SN
SO
SP
SQ
SR
SS
ST
SU
SV
SW
SX
SY
SZ
TA
TB
TC
TD
TE
TF
TG
TH
TI
TJ
TK
TL
TM
TN
TO
TP
TQ
TR
TS
TT
TU
TV
TW
TX
TY
TZ
UA
UB
UC
UD
UE
UF
UG
UH
UI
UJ
UK
UL
UM
UN
UO
UP
UQ
UR
US
UT
UU
UV
UW
UX
UY
UZ
VA
VB
VC
VD
VE
VF
VG
VH
VI
VJ
VK
VL
VM
VN
VO
VP
VQ
VR
VS
VT
VU
VV
VW
VX
VY
VZ
WA
WB
WC
WD
WE
WF
WG
WH
WI
WJ
WK
WL
WM
WN
WO
WP
WQ
WR
WS
WT
WU
WV
WW
WX
WY
WZ
XA
XB
XC
XD
XE
XF
XG
XH
XI
XJ
XK
XL
XM
XN
XO
XP
XQ
XR
XS
XT
XU
XV
XW
XX
XY
XZ
YA
YB
YC
YD
YE
YF
YG
YH
YI
YJ
YK
YL
YM
YN
YO
YP
YQ
YR
YS
YT
YU
YV
YW
YX
YY
YZ
ZA
ZB
ZC
ZD
ZE
ZF
ZG
ZH
ZI
ZJ
ZK
ZL
ZM
ZN
ZO
ZP
ZQ
ZR
ZS
ZT
ZU
ZV
ZW
ZX
ZY
ZZ



Atraumatische Magen- und Darmklemmen
 Non-traumatic Stomach and Intestinal Clamp Forceps
 Pinzas-clamps estomacales e intestinales Atrauma
 Pincers-clamps stomacales et pour l'intestin Atrauma
 Pinze stomacali e intestinali Atrauma

ATRAU
 nopa®

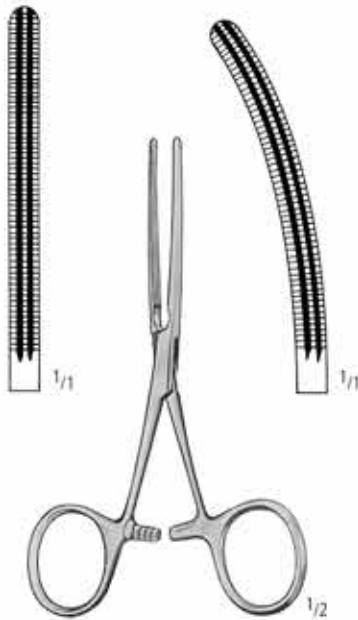

BABY KOCHER
 KD 252/13 13,0 cm/5" KD 253/13

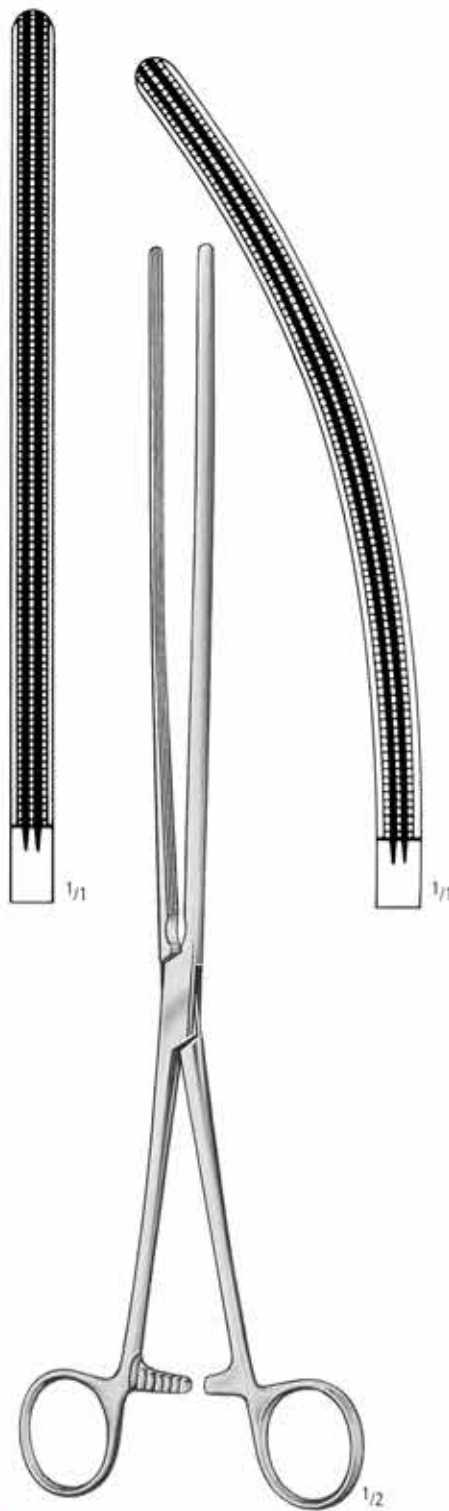

MAYO ROBSON
 KD 256/25 25,0 cm/10" KD 257/25

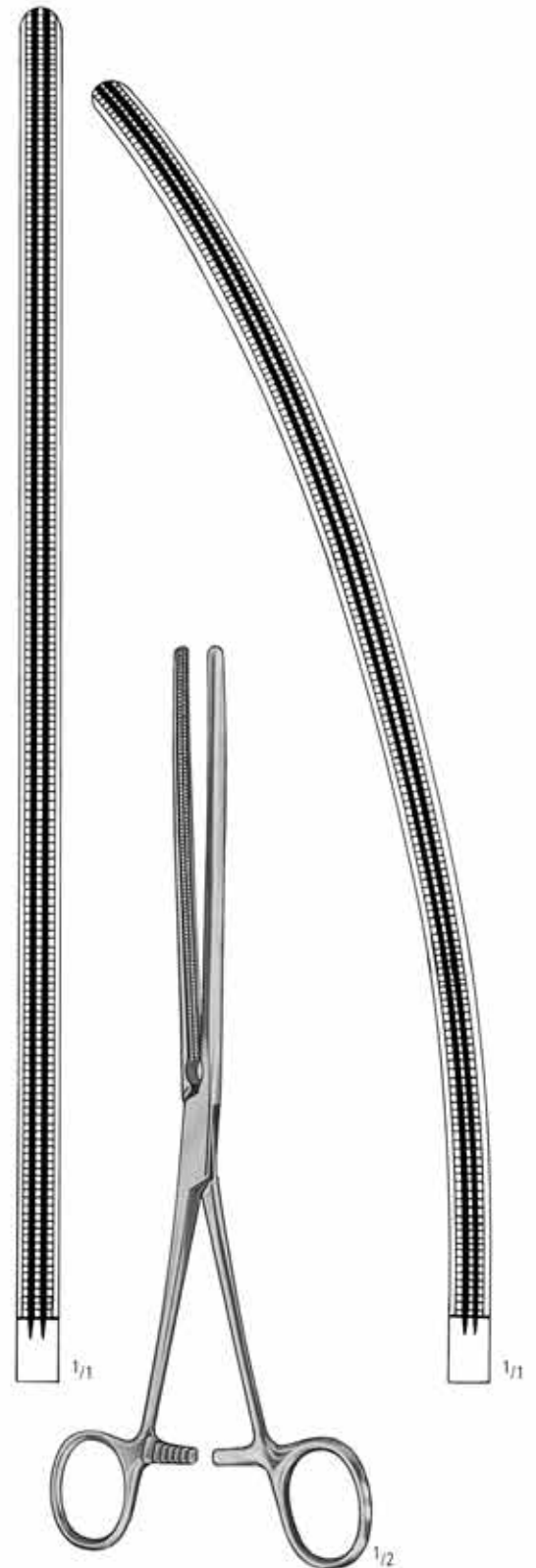

SCUDDER
 KD 258/33 33,0 cm/13" KD 259/33

Atraumatische Magen- und Darmklemmen
 Non-traumatic Stomach and Intestinal Clamp Forceps
 Pinzas-clamps estomacales e intestinales Atrauma
 Pincas-clamps stomacales et pour l'intestin Atrauma
 Pinze stomacali e intestinali Atrauma

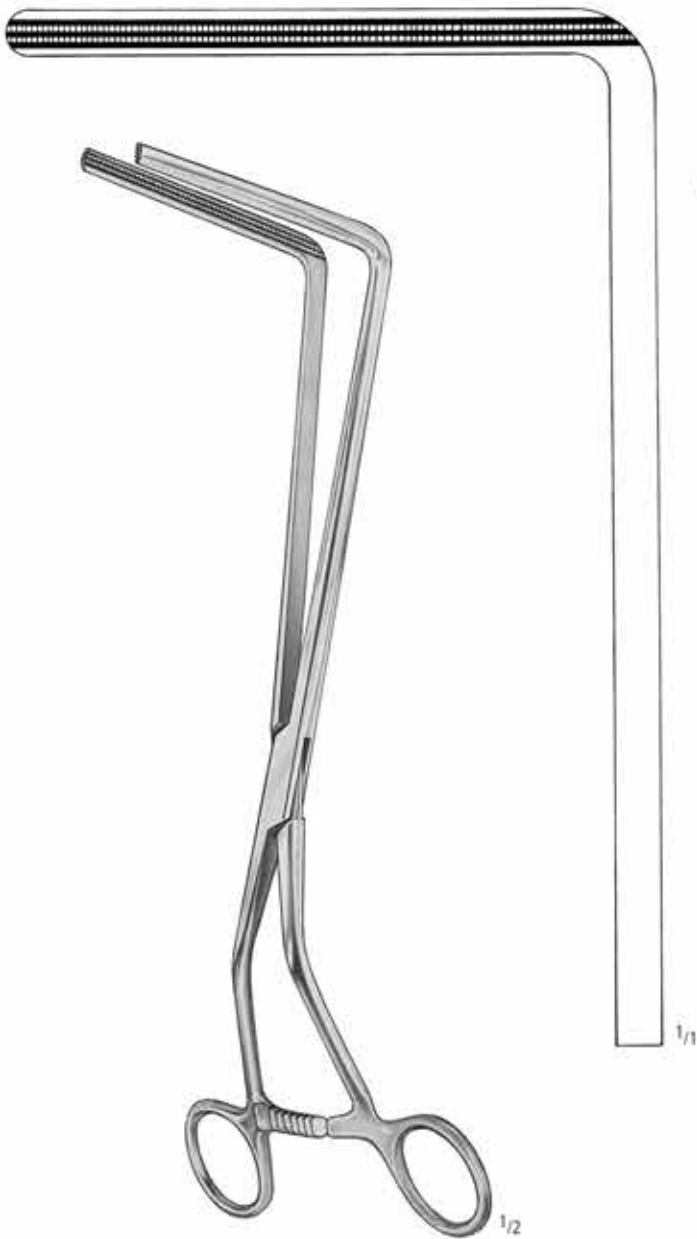

RESANO
KD 260/30
 30,0 cm/12"



FEHLAND
KD 270/24
 24,0 cm/9 1/2"

AA
 AB
 AC
 AD
 AE
 AF
 AK
 AL
 AM
 AO
 AP
 AR
 KA
 KU
 KY

KD

Anastomosenklemmen
 Anastomosis Forceps
 Pinzas para anastomosis
 Pincès à anastomose
 Pinze per anastomosi

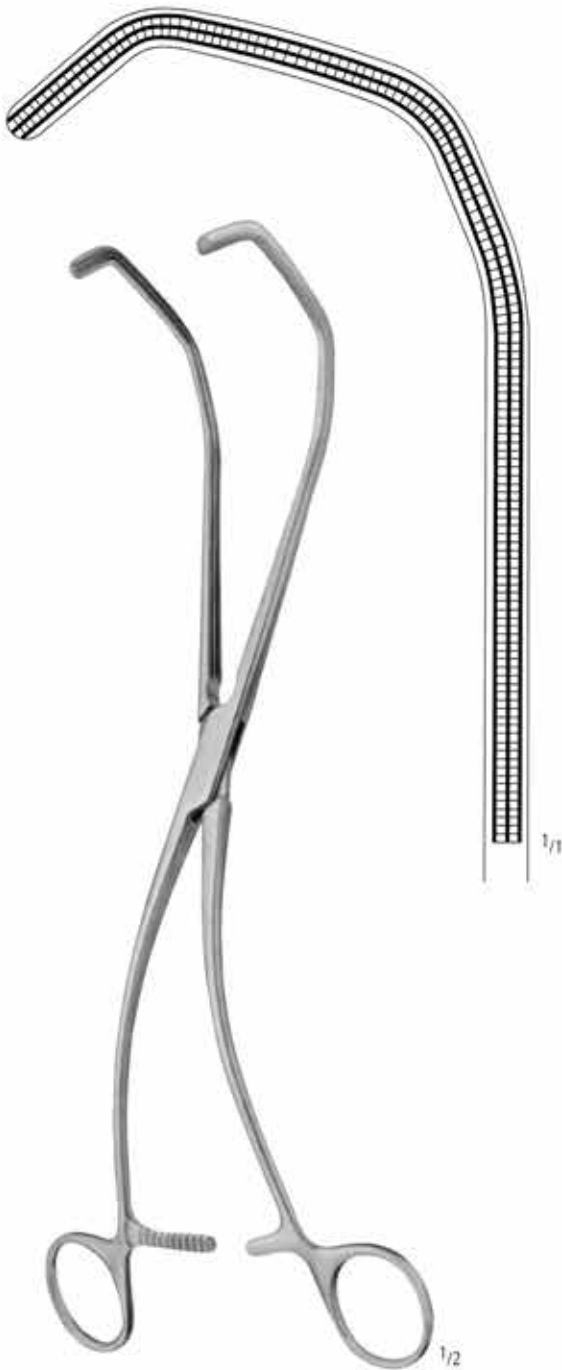

KERSTING
KD 273/30
 30,0 cm/12"



DICK

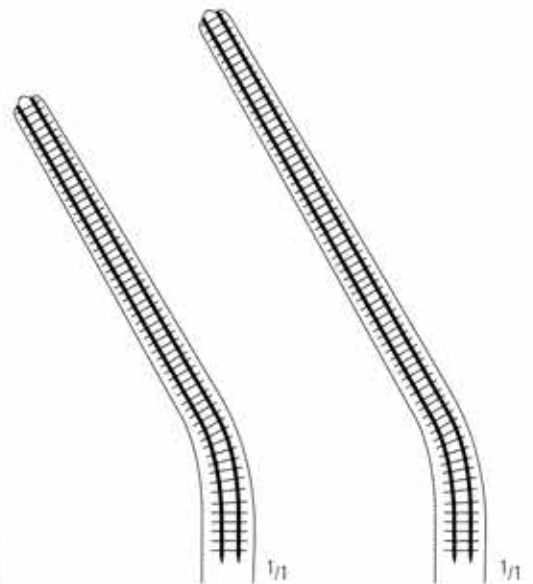

KD 275/01
 25,5 cm/10"

KD 275/02
 26,5 cm/10¹/₂"

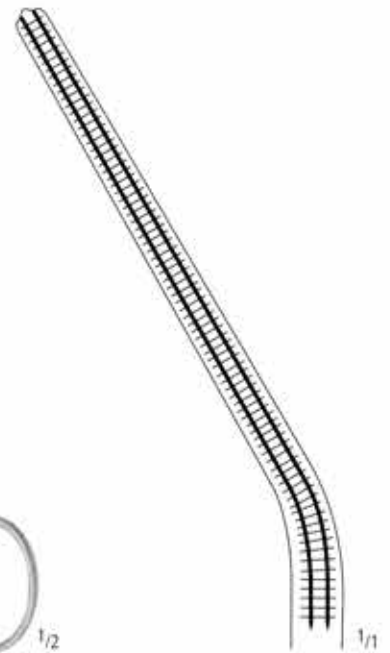

KD 275/03
 27,5 cm/10³/₄"

Anastomosenklemmen
 Anastomosis Forceps
 Pinzas para anastomosis
 Pinces à anastomose
 Pinze per anastomosi



LLOYD-DAVIS
KD 277/32
 31,5 cm/12¹/₂"

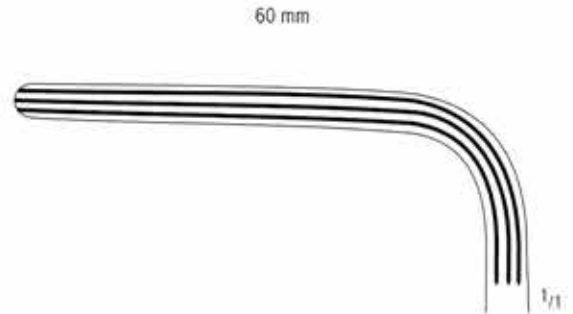

KD 279/60



KD 279/80



23,0 cm/9"

AA
 AB
 AC
 AD
 AE
 AF
 AK
 AL
 AM
 AO
 AP
 AR
 KA
 KU
 KY

KD

Darm- und Magenquetschklemmen
 Intestinal and Stomach Crushing Clamps
 Pinzas-clamps intestinales y estomacales
 Pincas-clamps et Ecraseurs pour l'intestin et l'estomac
 Pinze e Schiacciatori per intestino e stomaco

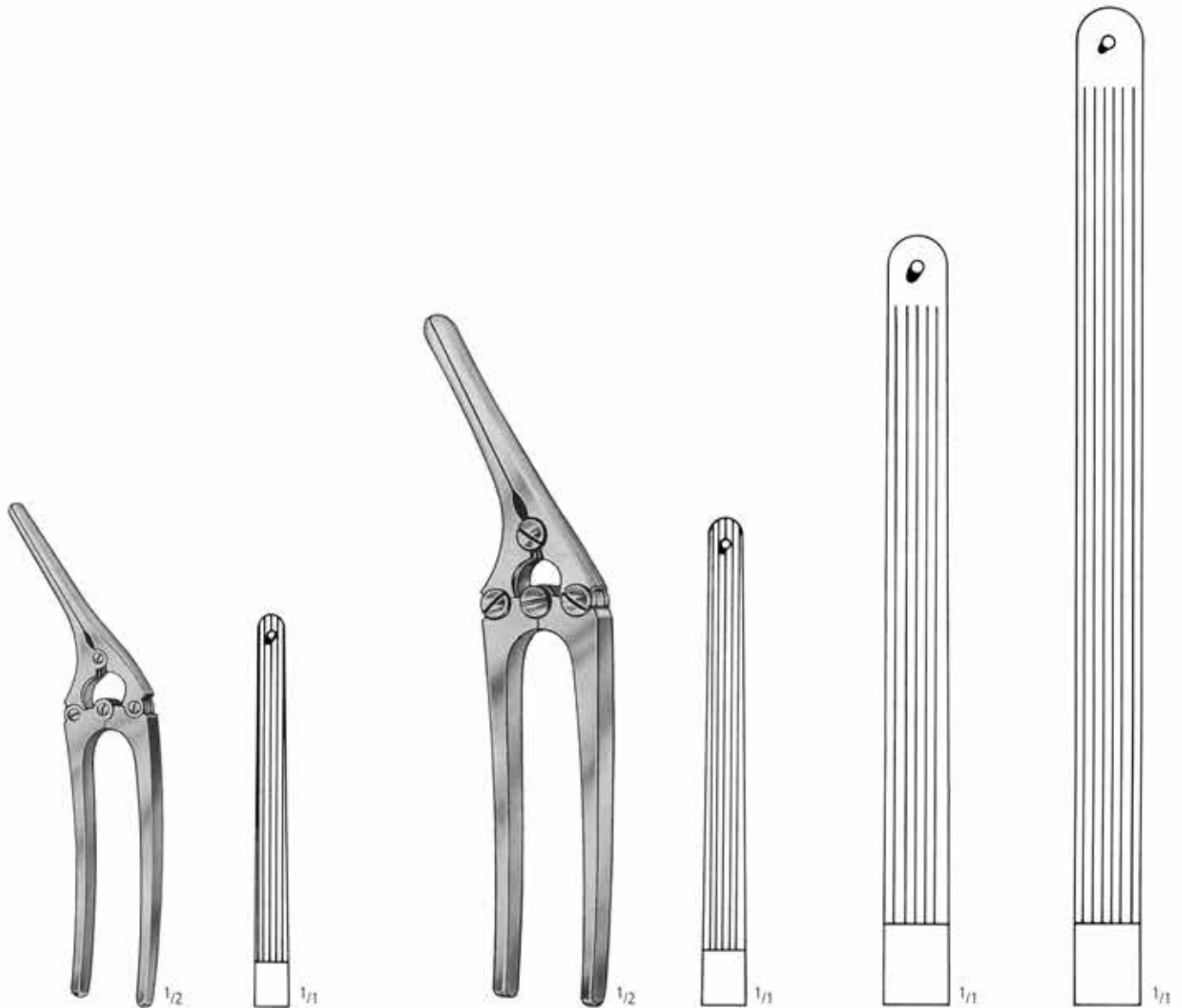

PAYR-BABY
 15,0 cm/6"

ohne Stift
 without pin
 sin espiga
 sans cheville
 senza perno

KD 310/15

mit Stift
 with pin
 con espiga
 avec cheville
 con perno

KD 312/15

PAYR

ohne Stift
 without pin
 sin espiga
 sans cheville
 senza perno

21,0 cm/8¹/₄"

KD 314/21

mit Stift
 with pin
 con espiga
 avec cheville
 con perno

KD 316/21

29,0 cm/11¹/₂"

KD 318/29

KD 320/29

35,0 cm/14"

KD 322/35

KD 324/35

Magenklemmen
 Stomach Clamp Forceps
 Pinzas-clamps estomacales
 Pincas-clamps stomacales
 Pinze stomacali

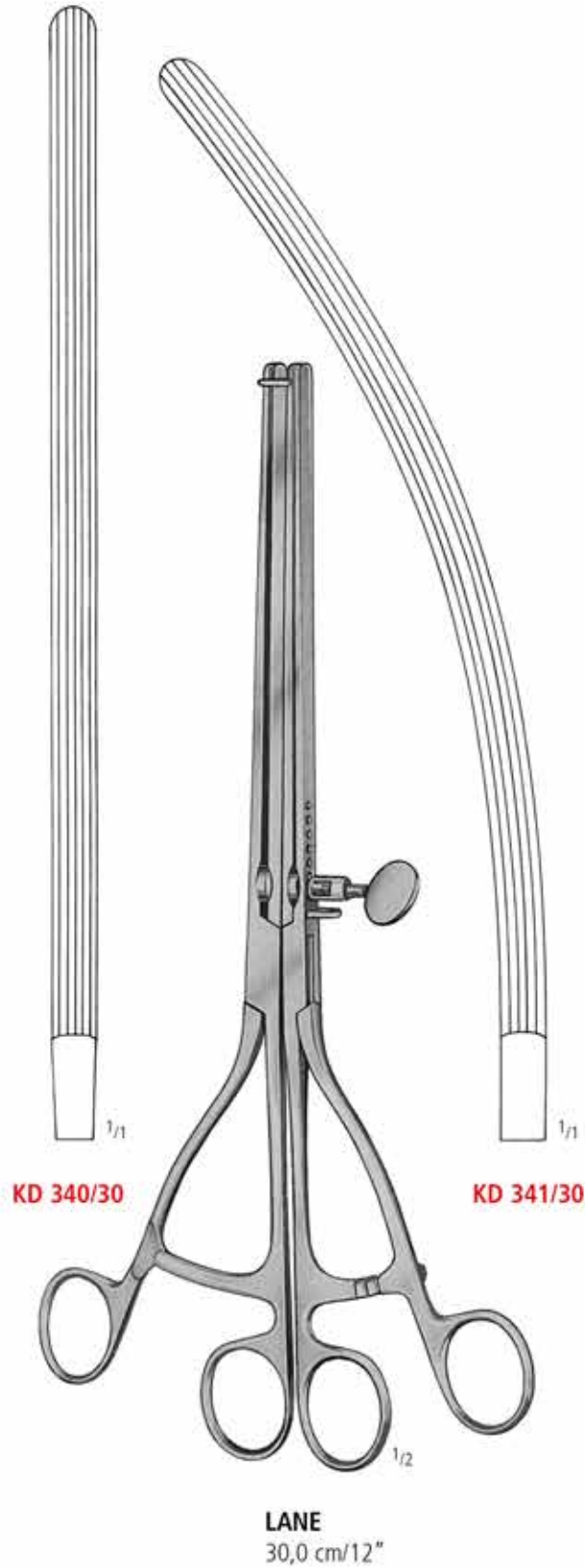

AA
 AB
 AC
 AD
 AE
 AF
 AG
 AH
 AI
 AJ
 AK
 AL
 AM
 AN
 AO
 AP
 AQ
 AR
 AS
 AT
 AU
 AV
 AW
 AX
 AY
 AZ
 BA
 BB
 BC
 BD
 BE
 BF
 BG
 BH
 BI
 BJ
 BK
 BL
 BM
 BN
 BO
 BP
 BQ
 BR
 BS
 BT
 BU
 BV
 BW
 BX
 BY
 BZ
 CA
 CB
 CC
 CD
 CE
 CF
 CG
 CH
 CI
 CJ
 CK
 CL
 CM
 CN
 CO
 CP
 CQ
 CR
 CS
 CT
 CU
 CV
 CW
 CX
 CY
 CZ
 DA
 DB
 DC
 DD
 DE
 DF
 DG
 DH
 DI
 DJ
 DK
 DL
 DM
 DN
 DO
 DP
 DQ
 DR
 DS
 DT
 DU
 DV
 DW
 DX
 DY
 DZ
 EA
 EB
 EC
 ED
 EE
 EF
 EG
 EH
 EI
 EJ
 EK
 EL
 EM
 EN
 EO
 EP
 EQ
 ER
 ES
 ET
 EU
 EV
 EW
 EX
 EY
 EZ
 FA
 FB
 FC
 FD
 FE
 FF
 FG
 FH
 FI
 FJ
 FK
 FL
 FM
 FN
 FO
 FP
 FQ
 FR
 FS
 FT
 FU
 FV
 FW
 FX
 FY
 FZ
 GA
 GB
 GC
 GD
 GE
 GF
 GG
 GH
 GI
 GJ
 GK
 GL
 GM
 GN
 GO
 GP
 GQ
 GR
 GS
 GT
 GU
 GV
 GW
 GX
 GY
 GZ
 HA
 HB
 HC
 HD
 HE
 HF
 HG
 HH
 HI
 HJ
 HK
 HL
 HM
 HN
 HO
 HP
 HQ
 HR
 HS
 HT
 HU
 HV
 HW
 HX
 HY
 HZ
 IA
 IB
 IC
 ID
 IE
 IF
 IG
 IH
 II
 IJ
 IK
 IL
 IM
 IN
 IO
 IP
 IQ
 IR
 IS
 IT
 IU
 IV
 IW
 IX
 IY
 IZ
 JA
 JB
 JC
 JD
 JE
 JF
 JG
 JH
 JI
 JJ
 JK
 JL
 JM
 JN
 JO
 JP
 JQ
 JR
 JS
 JT
 JU
 JV
 JW
 JX
 JY
 JZ
 KA
 KB
 KC
 KD
 KE
 KF
 KG
 KH
 KI
 KJ
 KK
 KL
 KM
 KN
 KO
 KP
 KQ
 KR
 KS
 KT
 KU
 KV
 KW
 KX
 KY
 KZ
 LA
 LB
 LC
 LD
 LE
 LF
 LG
 LH
 LI
 LJ
 LK
 LL
 LM
 LN
 LO
 LP
 LQ
 LR
 LS
 LT
 LU
 LV
 LW
 LX
 LY
 LZ
 MA
 MB
 MC
 MD
 ME
 MF
 MG
 MH
 MI
 MJ
 MK
 ML
 MM
 MN
 MO
 MP
 MQ
 MR
 MS
 MT
 MU
 MV
 MW
 MX
 MY
 MZ
 NA
 NB
 NC
 ND
 NE
 NF
 NG
 NH
 NI
 NJ
 NK
 NL
 NM
 NN
 NO
 NP
 NQ
 NR
 NS
 NT
 NU
 NV
 NW
 NX
 NY
 NZ
 OA
 OB
 OC
 OD
 OE
 OF
 OG
 OH
 OI
 OJ
 OK
 OL
 OM
 ON
 OO
 OP
 OQ
 OR
 OS
 OT
 OU
 OV
 OW
 OX
 OY
 OZ
 PA
 PB
 PC
 PD
 PE
 PF
 PG
 PH
 PI
 PJ
 PK
 PL
 PM
 PN
 PO
 PP
 PQ
 PR
 PS
 PT
 PU
 PV
 PW
 PX
 PY
 PZ
 QA
 QB
 QC
 QD
 QE
 QF
 QG
 QH
 QI
 QJ
 QK
 QL
 QM
 QN
 QO
 QP
 QQ
 QR
 QS
 QT
 QU
 QV
 QW
 QX
 QY
 QZ
 RA
 RB
 RC
 RD
 RE
 RF
 RG
 RH
 RI
 RJ
 RK
 RL
 RM
 RN
 RO
 RP
 RQ
 RR
 RS
 RT
 RU
 RV
 RW
 RX
 RY
 RZ
 SA
 SB
 SC
 SD
 SE
 SF
 SG
 SH
 SI
 SJ
 SK
 SL
 SM
 SN
 SO
 SP
 SQ
 SR
 SS
 ST
 SU
 SV
 SW
 SX
 SY
 SZ
 TA
 TB
 TC
 TD
 TE
 TF
 TG
 TH
 TI
 TJ
 TK
 TL
 TM
 TN
 TO
 TP
 TQ
 TR
 TS
 TT
 TU
 TV
 TW
 TX
 TY
 TZ
 UA
 UB
 UC
 UD
 UE
 UF
 UG
 UH
 UI
 UJ
 UK
 UL
 UM
 UN
 UO
 UP
 UQ
 UR
 US
 UT
 UY
 UZ
 VA
 VB
 VC
 VD
 VE
 VF
 VG
 VH
 VI
 VJ
 VK
 VL
 VM
 VN
 VO
 VP
 VQ
 VR
 VS
 VT
 VY
 VZ
 WA
 WB
 WC
 WD
 WE
 WF
 WG
 WH
 WI
 WJ
 WK
 WL
 WM
 WN
 WO
 WP
 WQ
 WR
 WS
 WT
 WY
 WZ
 XA
 XB
 XC
 XD
 XE
 XF
 XG
 XH
 XI
 XJ
 XK
 XL
 XM
 XN
 XO
 XP
 XQ
 XR
 XS
 XT
 XU
 XV
 XW
 XX
 XY
 XZ
 YA
 YB
 YC
 YD
 YE
 YF
 YG
 YH
 YI
 YJ
 YK
 YL
 YM
 YN
 YO
 YP
 YQ
 YR
 YS
 YT
 YZ
 ZA
 ZB
 ZC
 ZD
 ZE
 ZF
 ZG
 ZH
 ZI
 ZJ
 ZK
 ZL
 ZM
 ZN
 ZO
 ZP
 ZQ
 ZR
 ZS
 ZT
 ZY
 ZZ

KD

Darmklemmen, Anastomosenklemmen
 Intestinal and Anastomosis Clamp Forceps
 Pinzas-clamps intestinales y para anastomosis
 Pincers-clamps intestinales et à anastomose
 Pinze intestinali e per anastomosi



Maullänge
 jaw length
 largo de boca
 longueur des mors
 lunghezza del morso

5,0 cm/2" **KD 350/05**
 7,0 cm/2³/₄" **KD 350/07**
 10,0 cm/4" **KD 350/10**

DE MARTEL-WOLFSON

Satz zu 3 Anastomosenklemmen
 Set of 3 anastomosis clamps
 Juego de 3 clamps para anastomosis
 Jeu de 3 pincers-clamps à anastomose
 Serie di 3 pinze per anastomosi

Darmklemmen, Anastomosenklemmen
 Intestinal and Anastomosis Clamp Forceps
 Pinzas-clamps intestinales y para anastomosis
 Pincas-clamps intestinales et à anastomose
 Pinze intestinali e per anastomosi

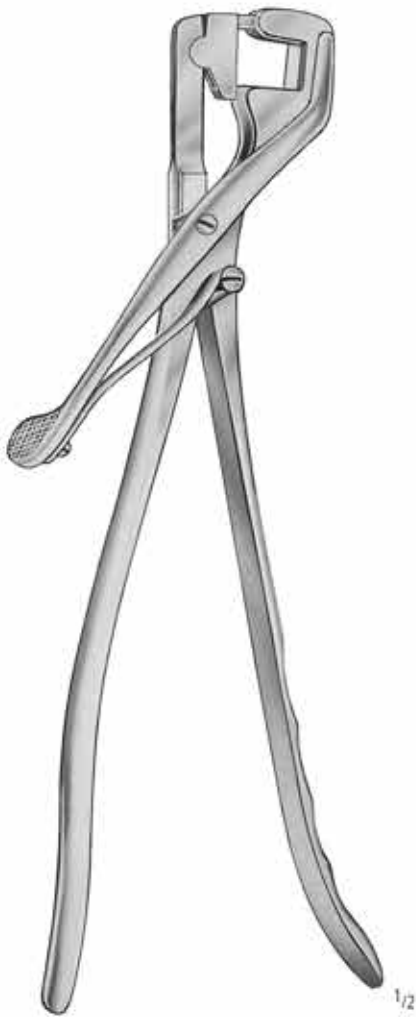

DE MARTEL-WOLFSON
KD 355/26
 26,0 cm/10¹/₂"



KD 370/08
 8,5 cm/3¹/₃"



DE MARTEL-WOLFSON
KD 370/23
 23,0 cm/9"

AA
 AB
 AC
 AD
 AE
 AF
 AK
 AL
 AM
 AO
 AP
 AR
 KA
 KU
 KY

KD

KD MASTDARM RECTUM RECTO RECTUM RETTO

Mastdarm - Spekula
Rectal Specula
Espécúlos rectales
Spéculums rectaux
Specoli rettali

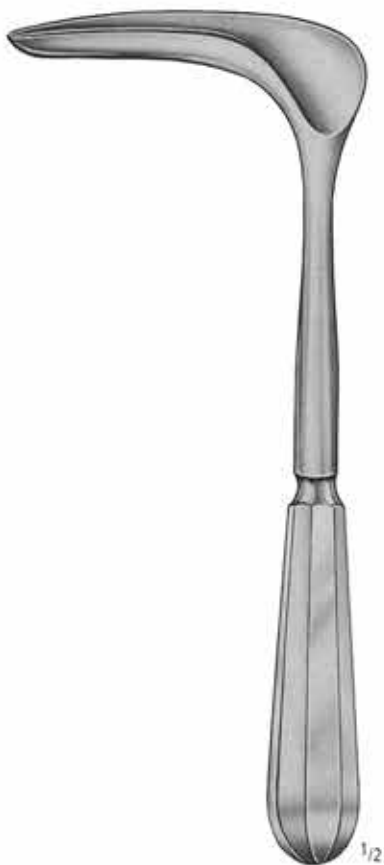

CZERNY
KD 618/22
22,0 cm/8³/₄"



SAWYER
KD 619/01 64 x 22 mm 270 mm
KD 619/02 75 x 30 mm 280 mm
KD 619/03 89 x 38 mm 280 mm

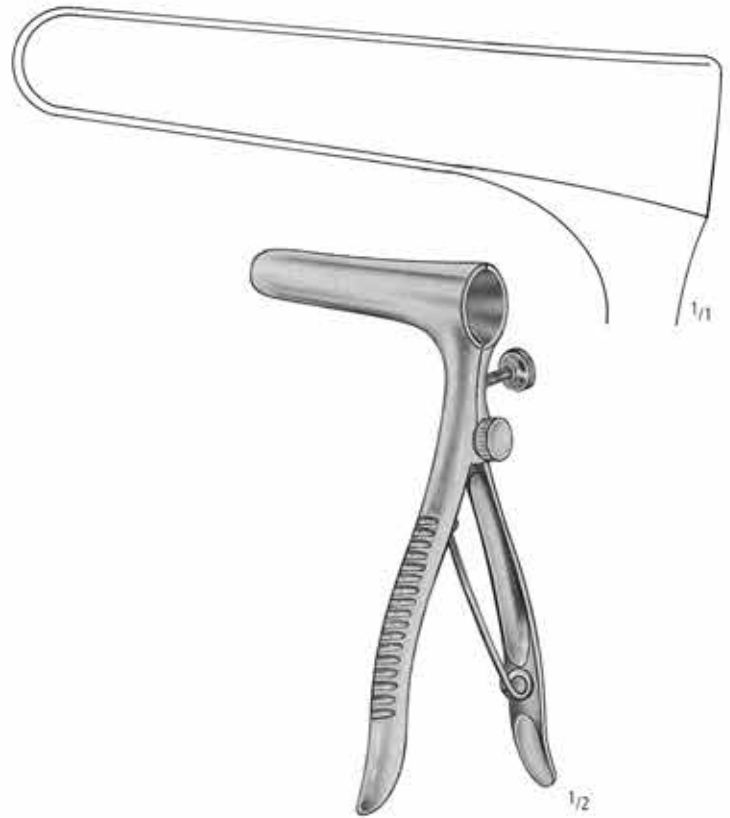

SIMS
KD 622/15
15,0 cm/6"



SIMS
KD 624/15
15,0 cm/6"

MASTDARM RECTUM RECTO RECTUM RETTO

Mastdarm - Spekula
 Rectal Specula
 Espéculos rectales
 Spéculums rectaux
 Specoli rettali

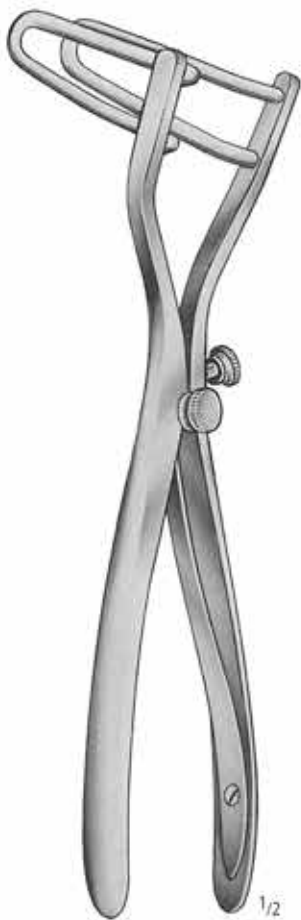

SCHULZE-BERGMANN
 22,0 cm/8³/₄"

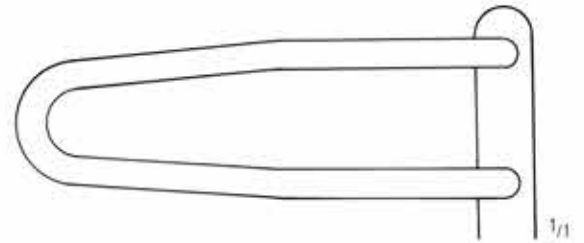

KD 630/06
 60 mm

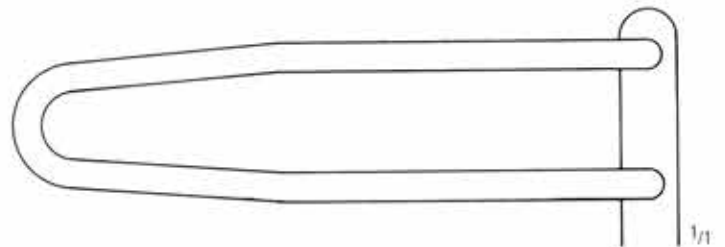

KD 630/08
 80 mm

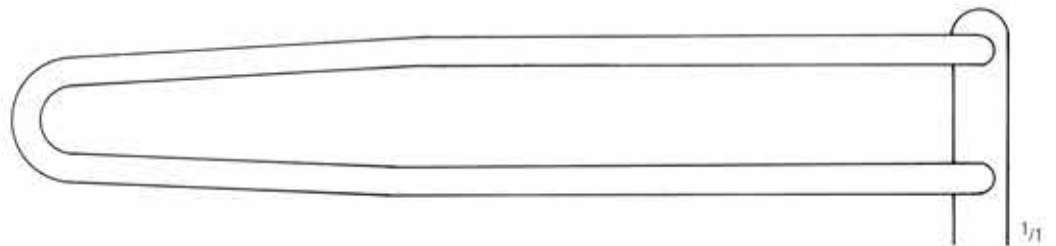

KD 630/12
 125 mm

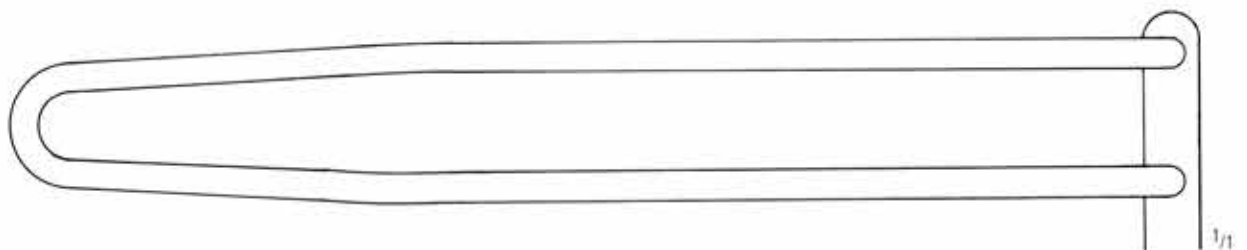

KD 630/15
 150 mm

AA
 AB
 AC
 AD
 AE
 AF
 AK
 AL
 AM
 AO
 AP
 AR
 KA
KD
 KU
 KY

KD MASTDARM RECTUM RECTO RECTUM RETTO

Mastdarm - Spekula
 Rectal Specula
 Espécules rectales
 Spéculums rectaux
 Specoli rettali



PRATT
KD 640/21
 21,5 cm/8½"
 85 x 25 mm

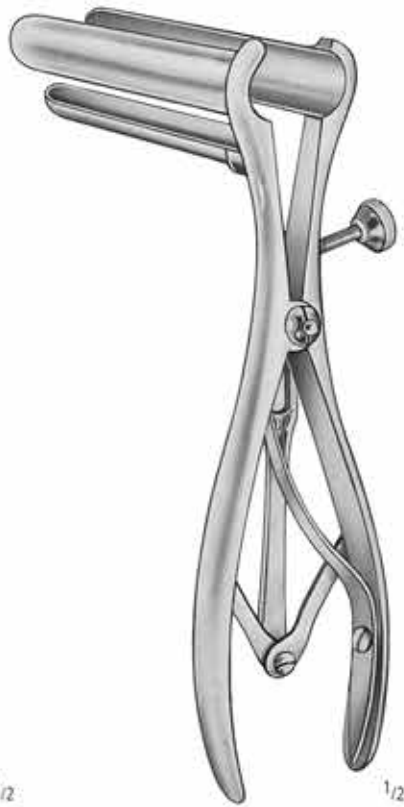

MATHIEU
KD 650/19
 19,5 cm/7¾"
 90 x 15 mm

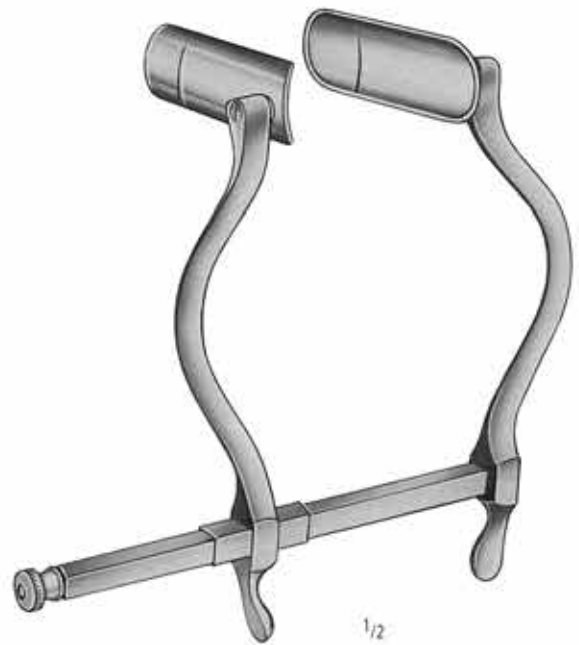

SMITH-BUIE
KD 660/15
 15,0 cm/6"
 75 x 23 mm

MASTDARM RECTUM RECTO RECTUM RETTO

Sphinkteroskope, Anuskope, Proktoskope
 Sphincteroscopes, Anoscopes, Proctoscopes
 Esfinteroscopios, Anoscopios, Proctoscopios
 Sphinctéroscoptes, Anuscopes, Proctoscopes
 Sfinteroscopi, Anoscopi, Protoscopi



ROSCHKE
KD 662/01
 Ø 15/30 x 70 mm



ROSCHKE
KD 662/02
 Ø 15/30 x 70 mm



ALAN PARKS
KD 665/01

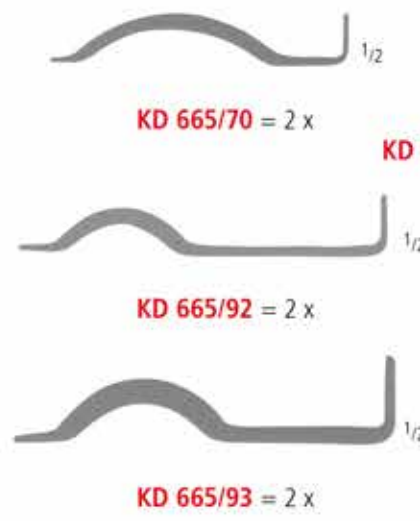

KD 665/70 = 2 x

KD 665/92 = 2 x

KD 665/93 = 2 x

komplett mit 2 Paar Valven
 complete with 2 pair of valves

KD 665/99 →

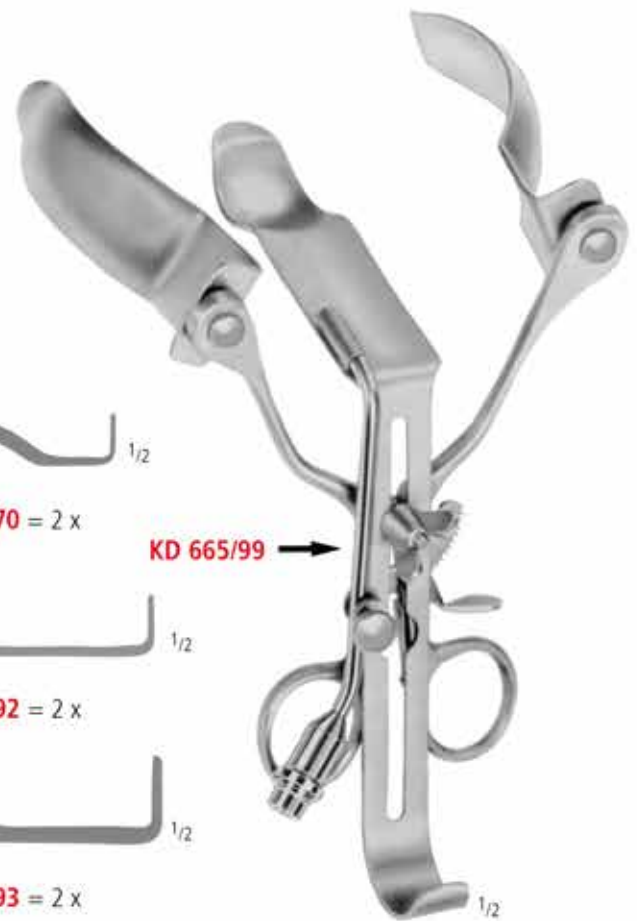

ALAN PARKS
KD 665/02

AA
 AB
 AC
 AD
 AE
 AF
 AG
 AH
 AI
 AJ
 AK
 AL
 AM
 AN
 AO
 AP
 AQ
 AR
 AS
 AT
 AU
 AV
 AW
 AX
 AY
 AZ
 BA
 BB
 BC
 BD
 BE
 BF
 BG
 BH
 BI
 BJ
 BK
 BL
 BM
 BN
 BO
 BP
 BQ
 BR
 BS
 BT
 BU
 BV
 BW
 BX
 BY
 BZ
 CA
 CB
 CC
 CD
 CE
 CF
 CG
 CH
 CI
 CJ
 CK
 CL
 CM
 CN
 CO
 CP
 CQ
 CR
 CS
 CT
 CU
 CV
 CW
 CX
 CY
 CZ
 DA
 DB
 DC
 DD
 DE
 DF
 DG
 DH
 DI
 DJ
 DK
 DL
 DM
 DN
 DO
 DP
 DQ
 DR
 DS
 DT
 DU
 DV
 DW
 DX
 DY
 DZ
 EA
 EB
 EC
 ED
 EE
 EF
 EG
 EH
 EI
 EJ
 EK
 EL
 EM
 EN
 EO
 EP
 EQ
 ER
 ES
 ET
 EU
 EV
 EW
 EX
 EY
 EZ
 FA
 FB
 FC
 FD
 FE
 FF
 FG
 FH
 FI
 FJ
 FK
 FL
 FM
 FN
 FO
 FP
 FQ
 FR
 FS
 FT
 FU
 FV
 FW
 FX
 FY
 FZ
 GA
 GB
 GC
 GD
 GE
 GF
 GG
 GH
 GI
 GJ
 GK
 GL
 GM
 GN
 GO
 GP
 GQ
 GR
 GS
 GT
 GU
 GV
 GW
 GX
 GY
 GZ
 HA
 HB
 HC
 HD
 HE
 HF
 HG
 HH
 HI
 HJ
 HK
 HL
 HM
 HN
 HO
 HP
 HQ
 HR
 HS
 HT
 HU
 HV
 HW
 HX
 HY
 HZ
 IA
 IB
 IC
 ID
 IE
 IF
 IG
 IH
 II
 IJ
 IK
 IL
 IM
 IN
 IO
 IP
 IQ
 IR
 IS
 IT
 IU
 IV
 IW
 IX
 IY
 IZ
 JA
 JB
 JC
 JD
 JE
 JF
 JG
 JH
 JI
 JJ
 JK
 JL
 JM
 JN
 JO
 JP
 JQ
 JR
 JS
 JT
 JU
 JV
 JW
 JX
 JY
 JZ
 KA
 KB
 KC
 KD
 KE
 KF
 KG
 KH
 KI
 KJ
 KK
 KL
 KM
 KN
 KO
 KP
 KQ
 KR
 KS
 KT
 KU
 KV
 KW
 KX
 KY
 KZ
 LA
 LB
 LC
 LD
 LE
 LF
 LG
 LH
 LI
 LJ
 LK
 LL
 LM
 LN
 LO
 LP
 LQ
 LR
 LS
 LT
 LU
 LV
 LW
 LX
 LY
 LZ
 MA
 MB
 MC
 MD
 ME
 MF
 MG
 MH
 MI
 MJ
 MK
 ML
 MM
 MN
 MO
 MP
 MQ
 MR
 MS
 MT
 MU
 MV
 MW
 MX
 MY
 MZ
 NA
 NB
 NC
 ND
 NE
 NF
 NG
 NH
 NI
 NJ
 NK
 NL
 NM
 NN
 NO
 NP
 NQ
 NR
 NS
 NT
 NU
 NV
 NW
 NX
 NY
 NZ
 OA
 OB
 OC
 OD
 OE
 OF
 OG
 OH
 OI
 OJ
 OK
 OL
 OM
 ON
 OO
 OP
 OQ
 OR
 OS
 OT
 OU
 OV
 OW
 OX
 OY
 OZ
 PA
 PB
 PC
 PD
 PE
 PF
 PG
 PH
 PI
 PJ
 PK
 PL
 PM
 PN
 PO
 PP
 PQ
 PR
 PS
 PT
 PU
 PV
 PW
 PX
 PY
 PZ
 QA
 QB
 QC
 QD
 QE
 QF
 QG
 QH
 QI
 QJ
 QK
 QL
 QM
 QN
 QO
 QP
 QQ
 QR
 QS
 QT
 QU
 QV
 QW
 QX
 QY
 QZ
 RA
 RB
 RC
 RD
 RE
 RF
 RG
 RH
 RI
 RJ
 RK
 RL
 RM
 RN
 RO
 RP
 RQ
 RR
 RS
 RT
 RU
 RV
 RW
 RX
 RY
 RZ
 SA
 SB
 SC
 SD
 SE
 SF
 SG
 SH
 SI
 SJ
 SK
 SL
 SM
 SN
 SO
 SP
 SQ
 SR
 SS
 ST
 SU
 SV
 SW
 SX
 SY
 SZ
 TA
 TB
 TC
 TD
 TE
 TF
 TG
 TH
 TI
 TJ
 TK
 TL
 TM
 TN
 TO
 TP
 TQ
 TR
 TS
 TT
 TU
 TV
 TW
 TX
 TY
 TZ
 UA
 UB
 UC
 UD
 UE
 UF
 UG
 UH
 UI
 UJ
 UK
 UL
 UM
 UN
 UO
 UP
 UQ
 UR
 US
 UT
 UY
 UZ
 VA
 VB
 VC
 VD
 VE
 VF
 VG
 VH
 VI
 VJ
 VK
 VL
 VM
 VN
 VO
 VP
 VQ
 VR
 VS
 VT
 VU
 VV
 VW
 VX
 VY
 VZ
 WA
 WB
 WC
 WD
 WE
 WF
 WG
 WH
 WI
 WJ
 WK
 WL
 WM
 WN
 WO
 WP
 WQ
 WR
 WS
 WT
 WU
 WV
 WW
 WX
 WY
 WZ
 XA
 XB
 XC
 XD
 XE
 XF
 XG
 XH
 XI
 XJ
 XK
 XL
 XM
 XN
 XO
 XP
 XQ
 XR
 XS
 XT
 XU
 XV
 XW
 XX
 XY
 XZ
 YA
 YB
 YC
 YD
 YE
 YF
 YG
 YH
 YI
 YJ
 YK
 YL
 YM
 YN
 YO
 YP
 YQ
 YR
 YS
 YT
 YU
 YV
 YW
 YX
 YZ
 ZA
 ZB
 ZC
 ZD
 ZE
 ZF
 ZG
 ZH
 ZI
 ZJ
 ZK
 ZL
 ZM
 ZN
 ZO
 ZP
 ZQ
 ZR
 ZS
 ZT
 ZU
 ZV
 ZW
 ZX
 ZY
 ZZ

KD MASTDARM RECTUM RECTO RECTUM RETTO

Sphinkterskope, Anuskope, Proktoskope
 Sphincteroscopes, Anoscopes, Proctoscopes
 Esfinteroscopios, Anoscopios, Proctoscopios
 Sphinctérosopes, Anoscopes, Proctoscopes
 Sfinteroscopi, Anoscopi, Protoscopi



IVES-FANSLER
KD 668/22
 Ø 22 mm



IVES-FANSLER
KD 669/22
 Ø 22 mm

← KD 669/99

MASTDARM RECTUM RECTO RECTUM RETTO

Sphinkterskope, Anuskope, Proktoskope
 Sphincteroscopes, Anoscopes, Proctoscopes
 Esfinteroscopios, Anoscopios, Proctoscopios
 Sphinctéroscoptes, Anuscopes, Proctoscopes
 Sfinteroscopi, Anoscopi, Protoscopi



HIRSCHMANN
KD 670/01 = 16 mm Ø x 65 mm
KD 670/02 = 19 mm Ø x 65 mm
KD 670/03 = 22 mm Ø x 65 mm
KD 670/04 = 22 mm Ø x 125 mm



HIRSCHMANN
KD 671/01 = 16 mm Ø x 60 mm
KD 671/02 = 19 mm Ø x 70 mm
KD 671/03 = 22 mm Ø x 90 mm
KD 671/04 = 22 mm Ø x 130 mm

AA
 AB
 AC
 AD
 AE
 AF
 AG
 AH
 AI
 AJ
 AK
 AL
 AM
 AN
 AO
 AP
 AQ
 AR
 AS
 AT
 AU
 AV
 AW
 AX
 AY
 AZ

KD

KU
 KY

KD MASTDARM RECTUM RECTO RECTUM RETTO

Sphinkteroskope, Anuskope, Proktoskope
 Sphincteroscopes, Anoscopes, Proctoscopes
 Esfinteroscopios, Anoscopios, Proctoscopios
 Sphinctérosopes, Anoscopes, Proctoscopes
 Sfinteroscopi, Anoscopi, Protoscopi

**BENSAUDE**

KD 675/19 = 19 mm Ø x 70 mm

KD 675/22 = 22 mm Ø x 70 mm

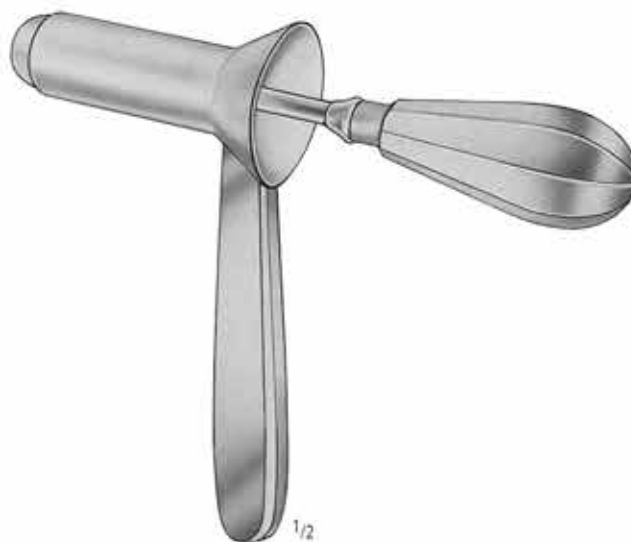
**KELLY**

KD 680/05 = 22 mm Ø x 50 mm

KD 680/10 = 22 mm Ø x 100 mm

KD 680/14 = 22 mm Ø x 140 mm

KD 680/20 = 22 mm Ø x 200 mm

MASTDARM RECTUM RECTO RECTUM RETTO

Sphinkterskope, Anuskope, Proktoskope
 Sphincteroscopes, Anoscopes, Proctoscopes
 Esfinteroscopios, Anoscopios, Proctoscopios
 Sphinctérosopes, Anusopes, Proctosopes
 Sfinteroscopi, Anoscopi, Protoscopi



KELLY

KD 685/21 = 21 mm Ø x 50 mm

KD 685/27 = 27 mm Ø x 50 mm



MORGAN

KD 690/01 = 17 mm Ø x 65 mm

KD 690/02 = 17 mm Ø x 80 mm

KD 690/03 = 20 mm Ø x 65 mm

KD 690/04 = 20 mm Ø x 80 mm

KD 690/05 = 24 mm Ø x 65 mm

KD 690/06 = 24 mm Ø x 80 mm



MORGAN

KD 690/99

KALTLICHT / FIBRE OPTIC

AA
AB
AC
AD
AE
AF
AK
AL
AM
AO
AP
AR
KA
KD
KU
KY

KD MASTDARM RECTUM RECTO RECTUM RETTO

Anuskope, Proktoskope
 Anoscopes, Proctoscopes
 Anoscopios, Proctoscopios
 Anuscopes, Proctoscopes
 Anoscopi, Proctoscopi

BLOND

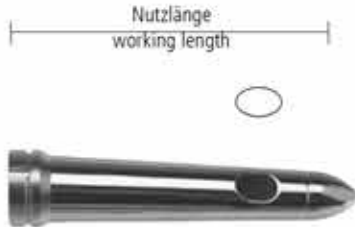

KD 700/01
 18/24 mm Ø x 75 mm



KD 700/02
 18/24 mm Ø x 75 mm



KD 700/03
 15/23 mm Ø x 75 mm



KD 700/04
 18/25 mm Ø x 105 mm



KD 702/01
 26 mm Ø x 60 mm



KD 702/02
 21 mm Ø x 80 mm



KD 702/03
 24 mm Ø x 80 mm



KD 702/04
 21 mm Ø x 120 mm

MASTDARM RECTUM RECTO RECTUM RETTO

Anuskope, Proktoskope
Anoscopes, Proctoscopes
Anoscopios, Proctoscopios
Anusopes, Proctosopes
Anoscopi, Proctoscopi



KD 705/01



**KD 705/02 = KD 705/80
KD 705/90
KD 705/99**

**GRIFFE FÜR KD 700/01 - KD 702/04
HANDLES FOR KD 700/01 - KD 702/04**



**BLOND
KD 707/01 = KD 705/01
KD 700/01**



**BLOND
KD 707/02 = KD 705/02
KD 700/01**

AA
AB
AC
AD
AE
AF
AK
AL
AM
AO
AP
AR
KA
KD
KU
KY

Rektoskope
 Rectoscopes
 Rectoscopios
 Rektoskopes
 Rectoscopi



KALTLICHT KOPF
F/O HEAD
KD 715/01



KALTLICHT
FIBRE OPTIC
KD 715/02

GRIFFE FÜR NACHFOLGENDE TUBEN
HANDLES FOR TUBES SHOWN NEXT PAGES



KD 717/01
KOPF für **KD 717/02**
HEAD for **KD 717/02**



WARMLICHT
BATTERY
KD 717/02

MASTDARM RECTUM RECTO RECTUM RETTO

Rektoskope
Rectoscopes
Rectoscopios
Rektoskopes
Rectoscopi



DIAGNOSTIC
KD 719/15 = 15 mm Ø x 200 mm



PROKTOSKOP
KD 720/00 = 18/24 mm Ø x 75 mm



ANUSKOP
KD 722/00 = 21 mm Ø x 80 mm



KALTLICHT / FIBRE OPTIC
KD 722/99
62 mm

AA
AB
AC
AD
AE
AF
AK
AL
AM
AO
AP
AR
KA
KD
KU
KY

KD

KD MASTDARM RECTUM RECTO RECTUM RETTO

Rektoskope
 Rectoscopes
 Rectoscopios
 Rektoskopes
 Rectoscopi



KD 724/20 = 20 mm Ø x 200 mm
KD 724/25 = 20 mm Ø x 250 mm
KD 724/30 = 20 mm Ø x 300 mm



KD 725/20 = 200 mm
KD 725/25 = 250 mm
KD 725/30 = 300 mm



**VERSCHLUSSDECKEL
 COVER CAP
 KD 731/00**



KD 729/99



**TELESKOPIK
 TELESCOPE
 KD 731/02**



**DOPPELGEBLÄSE MIT L/L
 DOUBLEBLOWER WITH L/L
 KD 731/04**

MASTDARM RECTUM RECTO RECTUM RETTO

Rektoskope
 Rectoscopes
 Rectoscopios
 Rektoskopes
 Rectoscopi

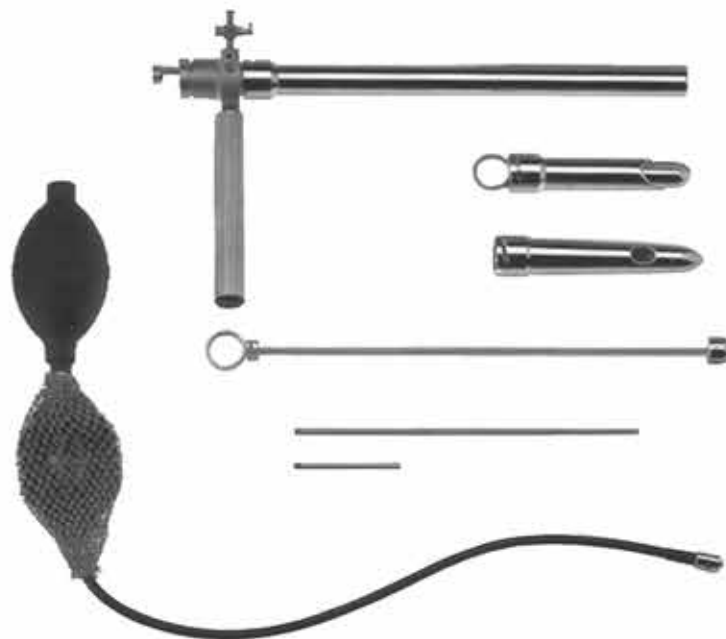

KD 740/00 = KD 715/01
 KD 731/00
 KD 731/01
 KD 715/02
 KD 724/25
 KD 725/25
 KD 728/25
 KD 720/00
 KD 722/00
 KD 722/99
 KD 731/04

REKTO - PROKTOSKOPSET MIT F/O - BELEUCHTUNG

F/O - Rektoskopkopf mit Zweiweghahn, Verschlussdeckel und Schwenklupe, Griff, Rektoskoptubus 250 mm, Ø 20 mm mit Mandrin und F/O Lichtträger, Anuskoptubus 80 mm, mit Mandrin, Proktoskoptubus mit Seitenfenster und kurzem F/O Lichtträger, Doppelgebläse.

RECTO - PROCTOSCOPE WITH F/O - ILLUMINATION

F/O - Rectoscope-head with two-way stop-cock, lens cover and swivel lens, handle, Rectoscope-tube 250 mm, Ø 20 mm, with obturator and F/O light-carrier, Anoscope-tube 80 mm with obturator, Proctoscope-tube with lateral window and short F/O light-carrier, double blower.

AA

AB

AC

AD

AE

AF

AK

AL

AM

AO

AP

AR

KA

KD

KU

KY

Rektoskope
 Rectoscopes
 Rectoscopios
 Rektoskopes
 Rectoscopi

STRAUSS



KD 741/00 = KD 715/01
 KD 715/02
 KD 731/00
 KD 731/02
 KD 724/20
 KD 724/25
 KD 724/30
 KD 725/20
 KD 725/25
 KD 725/30
 KD 728/20
 KD 728/25
 KD 728/30
 KD 731/04

F/O - REKTOSKOP NACH STRAUSS

F/O - Rektoskopkopf mit Zweiweghahn, Verschlussdeckel und Teleskop-Optik, Griff, je ein Rektoskoptubus in 200 mm, 250 mm und 300 mm, Ø 20 mm, mit Mandrin und F/O Lichtträger, Doppelgebläse.

F/O - RECTOSCOPE BY STRAUSS

F/O - Rectoscope-head with two-way stop-cock, lens cover and telescope, handle, 3 Rectoscope-tubes Ø 20 mm, with obturator and F/O light-carrier 200 mm, 250 mm and 300 mm, double blower.

MASTDARM RECTUM RECTO RECTUM RETTO

Rektoskope
 Rectoscopes
 Rectoscopios
 Rektoskopes
 Rectoscopi

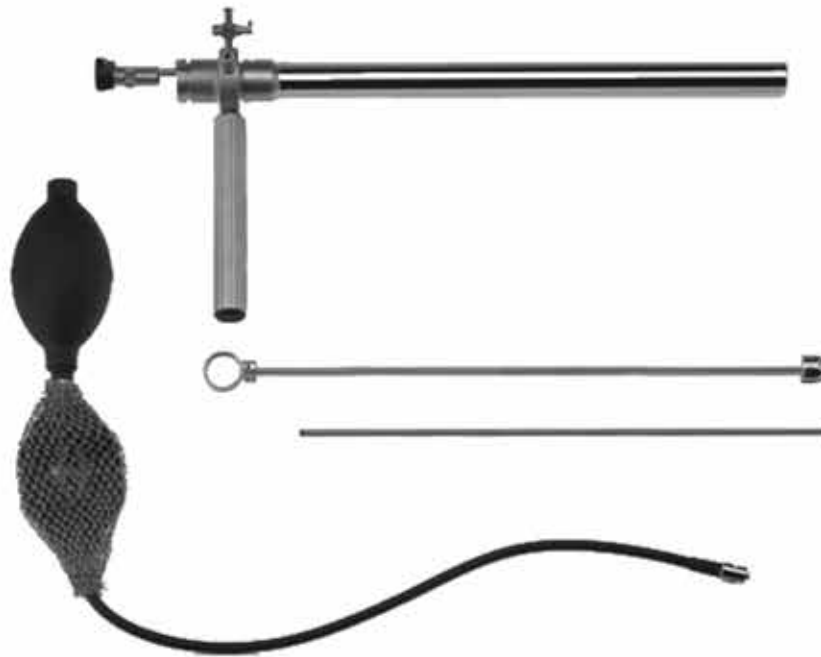

KD 742/00 = KD 715/01
KD 731/00
KD 731/02
KD 715/02
KD 724/30
KD 725/30
KD 728/30
KD 731/04

KOMPLETTES REKTOSKOPSET MIT F/O - BELEUCHTUNG

F/O - Rektoskopkopf mit Zweiweghahn, Verschlussdeckel und Teleskop-Optik, Griff, Rektoskoptubus in 300 mm Ø 20 mm, mit Mandrin und F/O Lichtträger, Doppelgebläse.

COMPLETE RECTOSCOPE WITH F/O - ILLUMINATION

F/O - Rectoscope-head with two-way stop-cock, lens cover and telescope, handle, Rectoscope-tube 300 mm, Ø 20 mm, with obturator and F/O light-carrier, double blower.

AA

AB

AC

AD

AE

AF

AK

AL

AM

AO

AP

AR

KA

KD

KU

KY

Rektoskope
 Rectoscopes
 Rectoscopios
 Rektoskopes
 Rectoscopi

**REKTOSKOP MIT KONVENTIONELLER BELEUCHTUNG
 RECTOSCOPE WITH CONVENTIONAL ILLUMINATION**



**KD 743/00 = KD 717/01
 KD 731/00
 KD 731/02
 KD 724/30
 KD 725/30
 KD 729/30
 KD 731/04
 KD 717/02**

KOMPLETTES REKTOSKOP MIT KONVENTIONELLER BELEUCHTUNG

Rektoskopkopf mit Zweiweghahn, Verschlussdeckel und Teleskop-Optik, Rektoskoptubus 300 mm, Ø 20 mm, mit Mandrin und Lampenträger, Doppelgebläse, Batteriegriff.

COMPLETE RECTOSCOPE WITH CONVENTIONAL ILLUMINATION

Rectoscope-head with two-way stop-cock, lens cover and telescope, Rectoscope-tube 300 mm, Ø 20 mm, with obturator and lamp-carrier, double blower, battery handle..

MASTDARM RECTUM RECTO RECTUM RETTO

Mastdarm - Biopsiezangen
 Rectal Biopsy Forceps
 Pinzas saca bocado para biopsia retal
 Pincas emporte-pièces à biopsie rectale
 Pinze tagliente per biopsia rettale

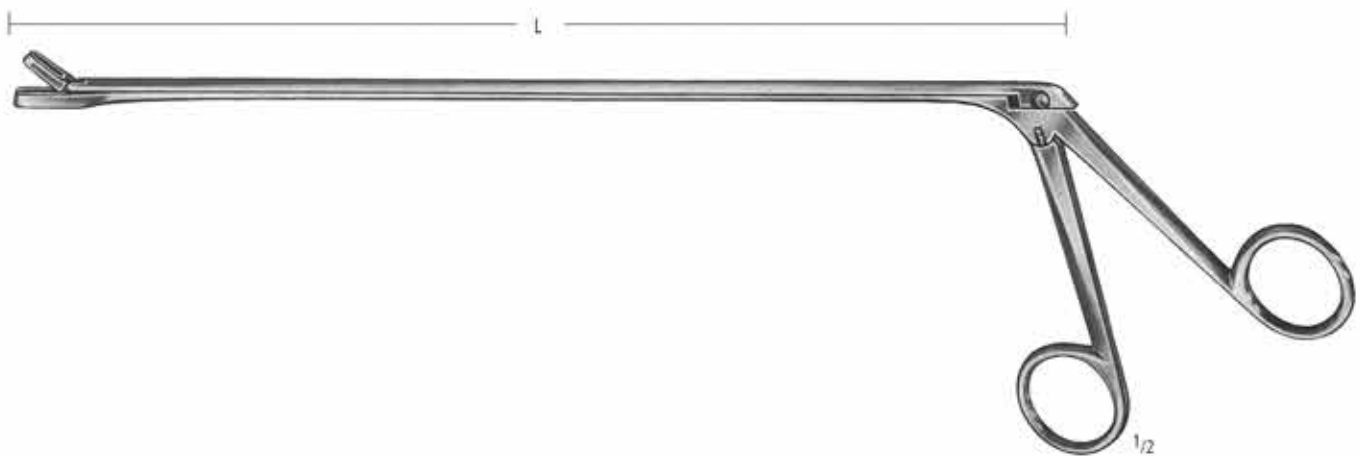

YEOMANN

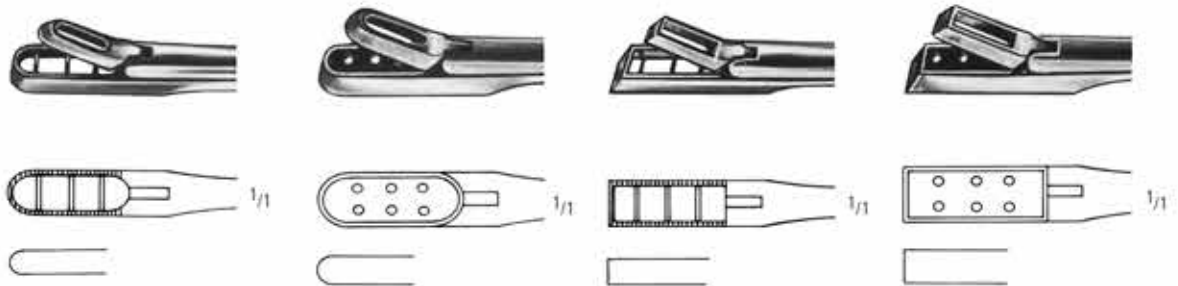

L = 28,0 cm/11"
 L = 35,0 cm/14"
 L = 42,0 cm/16¹/₂"

Fig. 1
KD 751/28
KD 751/35
KD 751/42

Fig. 2
KD 752/28
KD 752/35
KD 752/42

Fig. 3
KD 753/28
KD 753/35
KD 753/42

Fig. 4
KD 754/28
KD 754/35
KD 754/42

AA
 AB
 AC
 AD
 AE
 AF
 AK
 AL
 AM
 AO
 AP
 AR
 KA
 KU
 KY

KD

KD MASTDARM RECTUM RECTO RECTUM RETTO

Hämorrhoidal-Ligatoren
 Haemorrhoidal Ligators
 Ligadores hemorroides
 Ligateurs hémorroïdes
 Legatori emorroidali

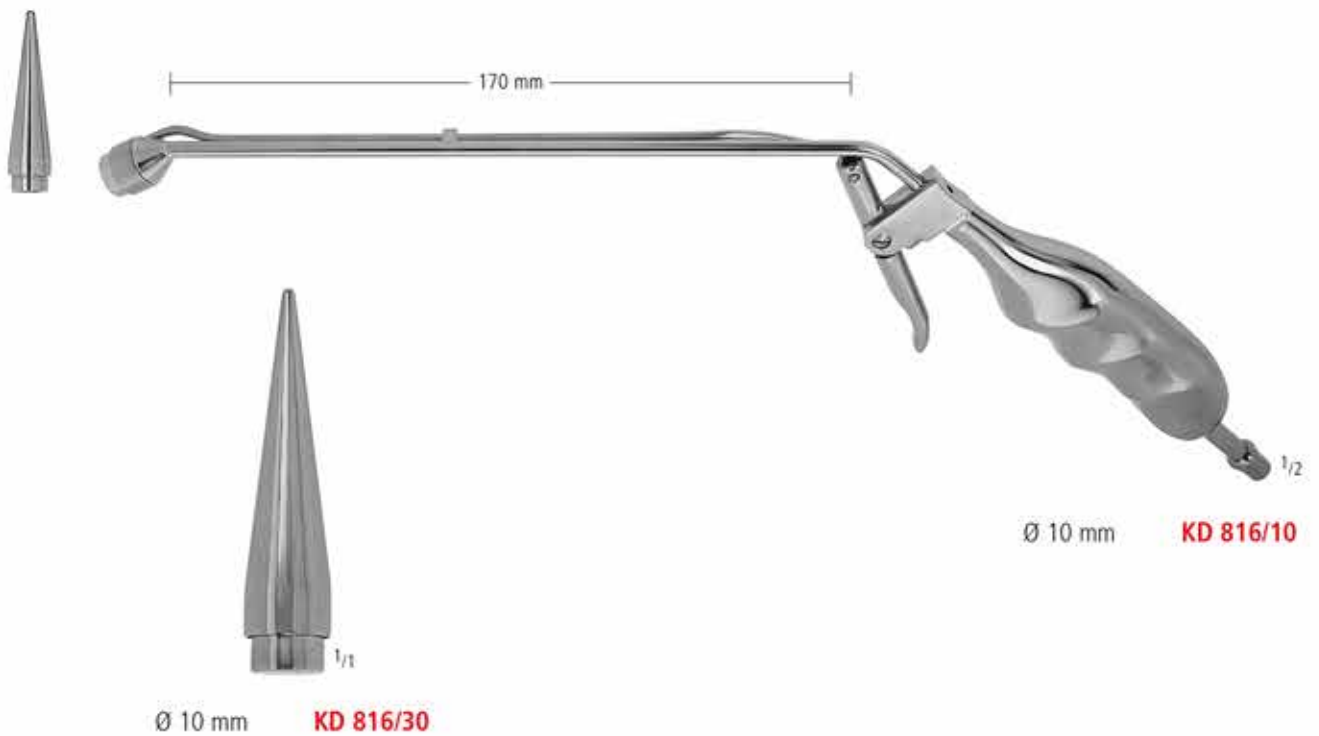
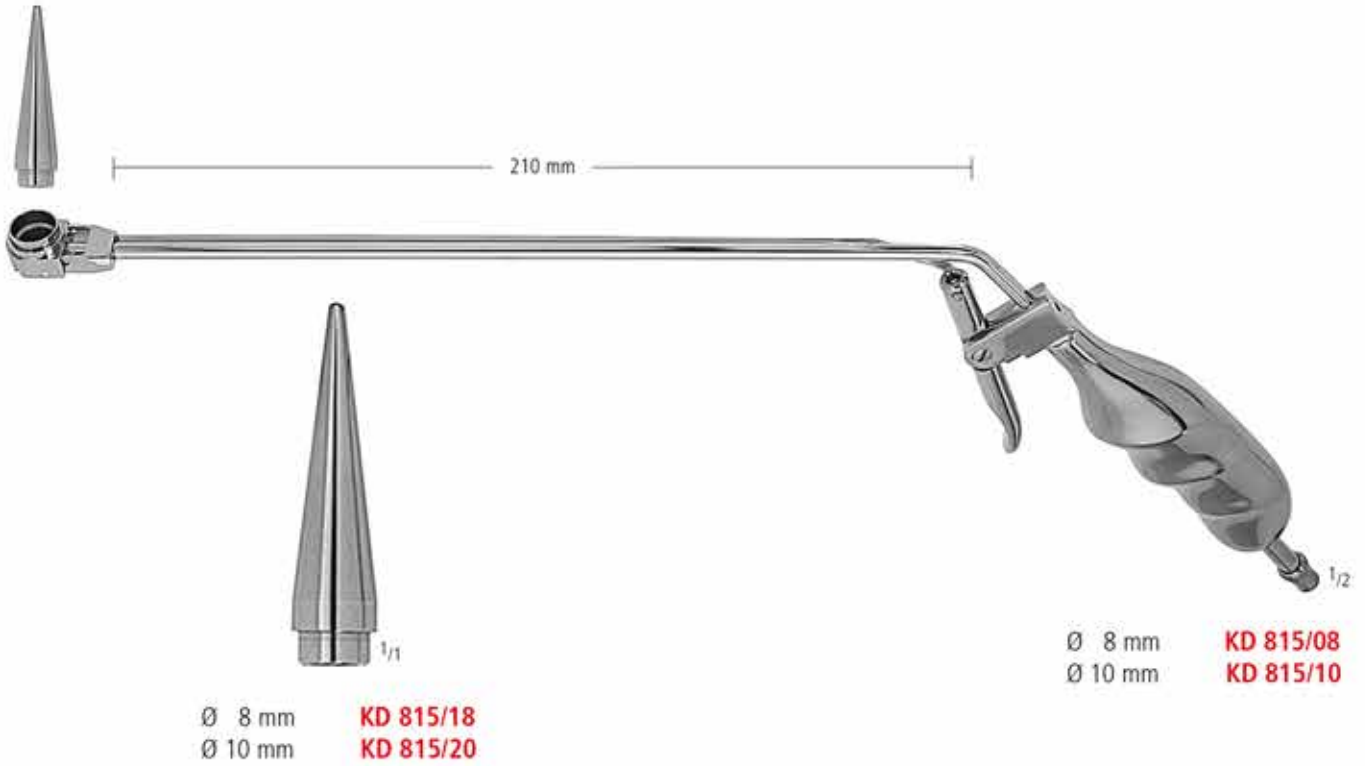

MASTDARM RECTUM RECTO RECTUM RETTO

Hämorrhoidal-Ligatoren
 Haemorrhoidal Ligators
 Ligadores hemorroides
 Ligateurs hémorroïdes
 Legatori emorroidali



KD 817/00

Ligatur-Gummiringe, 100 Stück
 O-rings, 100 pieces
 Anillos ligadura, 100 piezas
 Anneaux de caoutchouc, 100 pièces
 Anelli per legature, 100 pezzi



KD 818/01
 Ø 10 mm

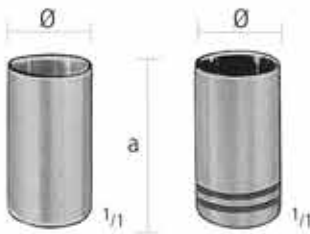

KD 818/11
 Ø 10 mm
 a = 11 mm

KD 818/16
 Ø 10 mm
 a = 16 mm



KD 818/00 =
 mit
 with
 con
 avec
 con
KD 818/01 + KD 818/11



MC GIVNEY
KD 820/19
 19,0 cm/7 1/2"

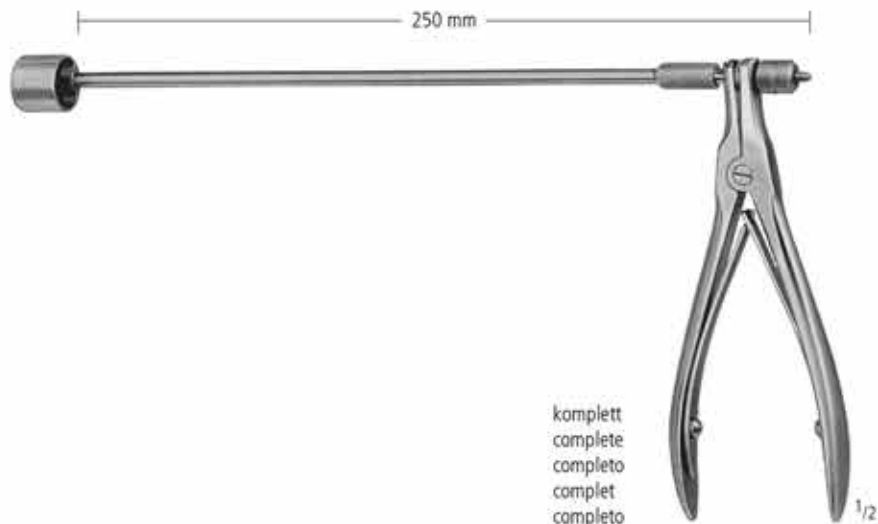

komplett
 complete
 completo
 complet
 completo

KD 820/00

AA
 AB
 AC
 AD
 AE
 AF
 AK
 AL
 AM
 AO
 AP
 AR
 KA
 KU
 KY

KD

KD MASTDARM RECTUM RECTO RECTUM RETTO

Hämorrhoidal-Ligatoren
Haemorrhoidal Ligators
Ligadores hemorroides
Ligateurs hémorroïdes
Legatori emorroidali



RUDD
KD 822/00



KD 822/12

VERSCHIEDENES
VARIOUS ITEMS
DIVERSOS ARTICULOS
ARTICLES DIVERS
ARTICOLI DIVERSI

KU

nopa[®] instruments





KU 210/10
ca. 100 cc



KU 211/12
ca. 120 cc



KU 280/12
110 x 30 mm 1,25 cl



KU 280/50
Ø = 100 mm



KU 284/10
Ø = 100 mm



KU 286/05
45 x 53 mm 0,05 l

AA
AB
AC
AD
AE
AF
AG
AH
AI
AJ
AK
AL
AM
AN
AO
AP
AQ
AR
AS
AT
AU
AV
AW
AX
AY
AZ

KU



Ø x h
 75 x 75 mm 0,3 l **KU 290/03**
 80 x 85 mm 0,4 l **KU 290/04**



Ø x h
 80 x 85 mm 0,4 l **KU 291/04**
 komplett mit Deckel
 complete with cap



Ø x h
 60 x 60 mm 0,15 l **KU 295/10**
 85 x 50 mm 0,25 l **KU 295/11**
 85 x 85 mm 0,40 l **KU 295/12**
 85 x 125 mm 0,60 l **KU 295/13**
 100 x 50 mm 0,35 l **KU 295/14**
 100 x 100 mm 0,75 l **KU 295/15**
 120 x 120 mm 1,25 l **KU 295/16**
 150 x 100 mm 1,75 l **KU 295/17**
 150 x 150 mm 2,50 l **KU 295/18**
 200 x 100 mm 3,00 l **KU 295/19**
 200 x 200 mm 6,00 l **KU 295/20**

komplett mit Deckel
 complete with cap



Ø x h		
40 x 19 mm	0,05 l	KU 300/04
61 x 30 mm	0,07 l	KU 300/06
80 x 40 mm	0,14 l	KU 300/08
116 x 50 mm	0,35 l	KU 300/11
128 x 55 mm	0,45 l	KU 300/12
147 x 65 mm	0,70 l	KU 300/14



KU 301/01	= 0,25 l
KU 301/02	= 0,50 l
KU 301/03	= 1,00 l
KU 301/04	= 2,00 l



L = 170 mm	KU 302/17
L = 250 mm	KU 302/25
L = 275 mm	KU 302/27

AA
AB
AC
AD
AE
AF
AG
AH
AI
AJ
AK
AL
AM
AN
AO
AP
AQ
AR
AS
AT
AU
AV
AW
AX
AY
AZ

KU



KU 303/00
Ø = 65 mm



KU 304/50 = 50 x 25 x 4,5 mm
KU 304/65 = 65 x 45 x 8,0 mm
KU 304/75 = 75 x 25 x 4,5 mm



KU 306/15 = 150 x 95 x 13 mm



l x b x h

230 x 155 x 30 mm

300 x 175 x 30 mm

300 x 175 x 40 mm

350 x 240 x 36 mm

400 x 300 x 50 mm

KU 307/23

KU 307/30

KU 308/30

KU 308/35

KU 308/50



l x b x h

210 x 160 x 10 mm

240 x 180 x 10 mm

310 x 150 x 10 mm

310 x 210 x 10 mm

350 x 240 x 10 mm

400 x 270 x 20 mm

420 x 280 x 10 mm

KU 309/21

KU 309/24

KU 309/31

KU 310/31

KU 310/35

KU 310/40

KU 310/42

AA

AB

AC

AD

AE

AF

AK

AL

AM

AO

AP

AR

KA

KD

KU

KY



Ø x h	l	
165 x 60 mm	0,75	KU 311/16
175 x 70 mm	1,00	KU 311/17
220 x 80 mm	2,00	KU 311/22
225 x 90 mm	2,50	KU 311/23
240 x 110 mm	3,00	KU 311/24
275 x 115 mm	4,50	KU 311/27
290 x 125 mm	6,00	KU 311/29
310 x 120 mm	6,00	KU 311/31
345 x 125 mm	8,50	KU 311/34
380 x 130 mm	11,00	KU 311/38



l x b x h	
16,5 x 9,0 x 3,5 cm	KU 312/16
20,0 x 10,0 x 5,0 cm	KU 312/20
22,0 x 15,0 x 5,0 cm	KU 312/22
26,0 x 15,0 x 5,0 cm	KU 312/26
30,5 x 20,5 x 5,0 cm	KU 312/30
30,0 x 15,0 x 5,0 cm	KU 312/31
50,0 x 20,0 x 10,0 cm	KU 312/50
50,0 x 20,0 x 12,0 cm	KU 312/51

Deckel ohne Knopf
Lid without knob
Tapa sin botón
Couvercle sans bouton
Coperchio senza pomolo

l x b x h	
16,5 x 9,0 x 3,5 cm	KU 313/16
20,0 x 10,0 x 5,0 cm	KU 313/20
22,0 x 15,0 x 5,0 cm	KU 313/22
26,0 x 15,0 x 5,0 cm	KU 313/26
30,5 x 20,5 x 5,0 cm	KU 313/30
30,0 x 15,0 x 5,0 cm	KU 313/31
50,0 x 20,0 x 10,0 cm	KU 313/50
50,0 x 20,0 x 12,0 cm	KU 313/51



Ø x h	
30 x 90 mm	KU 314/09
50 x 100 mm	KU 314/10
50 x 130 mm	KU 314/13
50 x 175 mm	KU 314/17
75 x 100 mm	KU 315/10
75 x 130 mm	KU 315/13
75 x 175 mm	KU 315/17



KU 316/10
350 x 270 x 100 mm



Ø 235 mm **KU 316/23**
Ø 310 mm **KU 316/31**



KU 316/42
230 x 120 mm
männlich / male



KU 316/43
220 x 135 mm
weiblich / female

AA
AB
AC
AD
AE
AF
AK
AL
AM
AO
AP
AR
KA
KD
KY

KU



MAYO
KU 318/14
14,0 cm/5½"



MAYO
KU 320/14
14,0 cm/5½"



CHEATLE
KU 321/27
27,0 cm/10¾"



ROGGE
KU 322/23
23,0 cm/9"



PYE-SMITH (HARRISON)
KU 323/25 25,0 cm/10"
KU 323/30 30,0 cm/12"



KU 325/18
18,0 cm/7"



KU 328/01
50 x 75 mm



KU 329/01
Ø 30,0 mm



KU 329/02
Ø 30,0 mm

Disposable dappen dish
Kunststoff - plastic - plástico - plastique - plastica



KU 332/01
Verpackungseinheit / packing unit 1000 St./pc.
250 pro Farbe / 250 per colour

Glass dappen dish
Glas - glass - cristal - verre - vetro



KU 333/01 **KU 333/02** **KU 333/04**

Verpackungseinheit / packing unit
2 St. pro Farbe / 2 pcs. per colour

Glas-Anmischplatten / glass mixing slabs

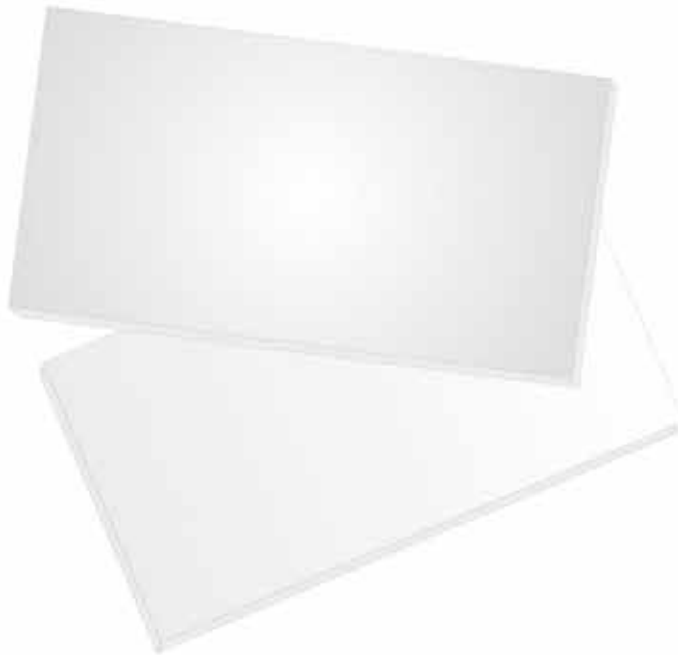

KU 335/02
150 x 80 x 2 mm



KU 340/01
Ø 11,0 mm
15,0 cm/6"



KU 340/02
Ø 11,0 mm
11,0 cm/4 1/3"



KU 340/03
Ø 11,0 mm
14,0 cm/5 1/2"

FUSSPFLEGE
PODIATRY
PEDICURA
SOINS DES PIEDS
PEDICURE

KU

nopa[®] instruments



Nagelzangen
Nail Nippers
Pinzas corta-uñas
Pincès à ongles
Tronchesine per unghie

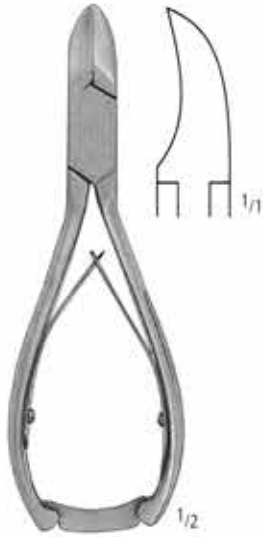

KU 800/14
14,0 cm/5 1/2"

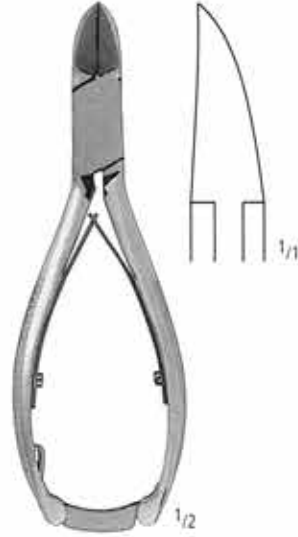

KU 802/14
14,0 cm/5 1/2"

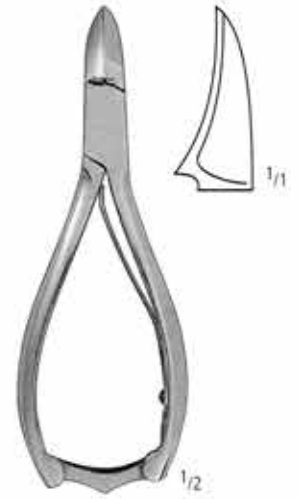

KU 803/13
13,0 cm/5"



TURNBULL

11,5 cm/4 1/2" **KU 804/11**
13,0 cm/5" **KU 804/13**



KU 806/14
14,0 cm/5 1/2"

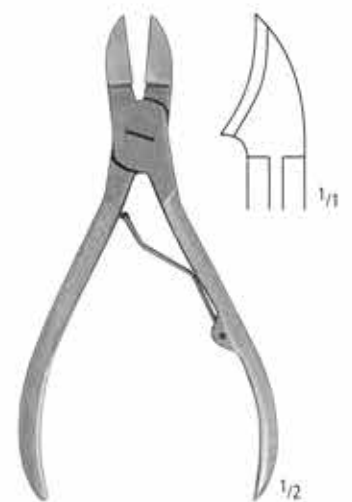

KU 808/14
14,0 cm/5 1/2"

Nagelzangen
Nail Nippers
Pinzas corta-uñas
Pincas à ongles
Tronchesine per unghie

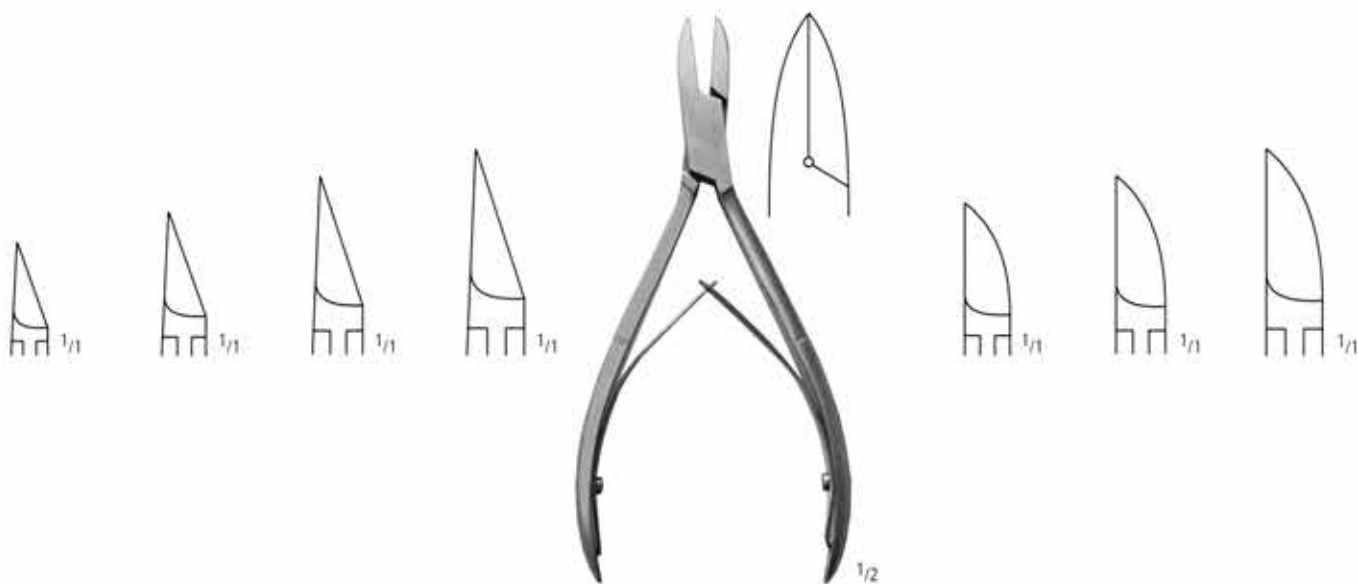

KU 810/10
KU 810/11
KU 810/12
KU 810/15

LITTAUER
10,0 cm/4"
11,0 cm/4¹/₃"
12,5 cm/5"
15,0 cm/6"

KU 811/11
KU 811/12
KU 811/15



KU 812/12
12,0 cm/4³/₄"

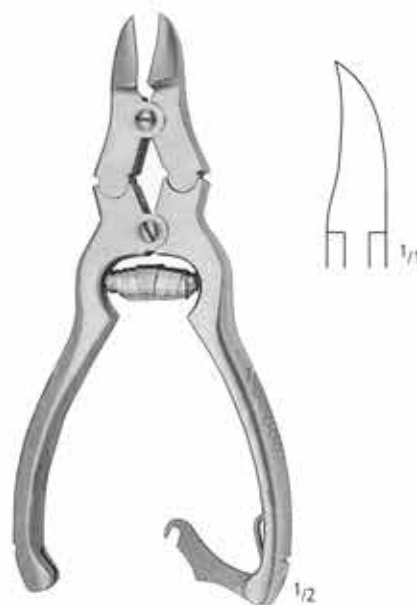
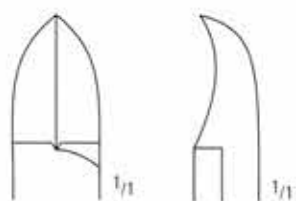

KU 814/15
14,5 cm/5³/₄"

AA
AB
AC
AD
AE
AF
AK
AL
AM
AO
AP
AR
KA
KD
KY
KU

Nagelzangen
 Nail Nippers
 Pinzas corta-uñas
 Pincas à ongles
 Tronchesine per unghie

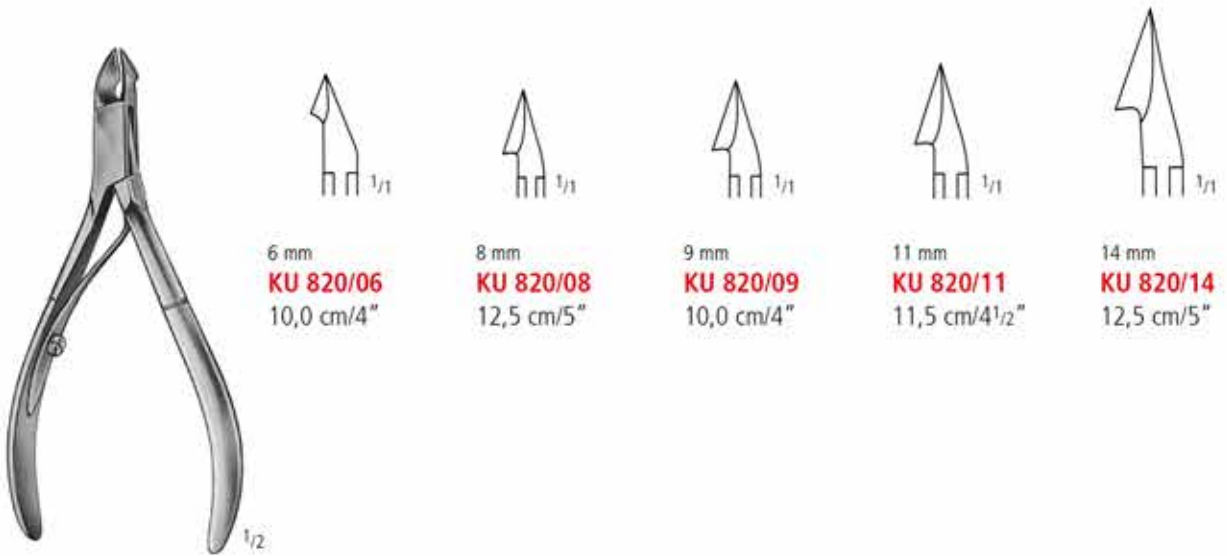



RADOLF
13,5 cm/5 1/4"



6 mm
KU 830/06



4 mm
KU 831/04



ANVIL
KU 832/12
12,5 cm/5"



KU 840/08
8,0 cm/3"



KU 842/10
10,0 cm/4"



KU 842/11



KU 842/12



KU 842/13

Satz - Set
KU 842/00 = **KU 842/10**
KU 842/11
KU 842/12
KU 842/13



KU 850/01
15,0 cm/6"



KU 850/02
15,0 cm/6"



KU 850/03
12,0 cm/4³/₄"



KU 850/04
13,5 cm/5¹/₄"



KU 850/05
13,5 cm/5¹/₄"



KU 850/06
13,0 cm/5"

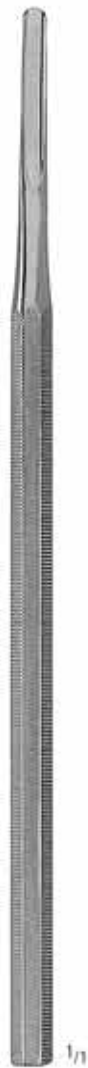

KU 850/07
14,0 cm/5 1/2"



KU 850/08
13,0 cm/5"



KU 850/09
14,0 cm/5 1/2"



KU 850/10
15,5 cm/6"

AA
AB
AC
AD
AE
AF
AK
AL
AM
AO
AP
AR
KA
KD
KY

KU



KU 850/20
14,0 cm/5 1/2"



KU 850/21
14,0 cm/5 1/2"



KU 850/22
14,0 cm/5 1/2"



Ø 1,0 mm **KU 850/30**
Ø 1,5 mm **KU 850/31**
Ø 2,0 mm **KU 850/32**
Ø 2,5 mm **KU 850/33**
12,5 cm/5"



KU 850/35
12,5 cm/5"



KU 854/01
13,0 cm/5"



KU 854/02
12,0 cm/4³/₄"



KU 854/03
11,0 cm/4¹/₃"



KU 854/04
14,0 cm/5¹/₂"



KU 854/05
11,0 cm/4¹/₃"

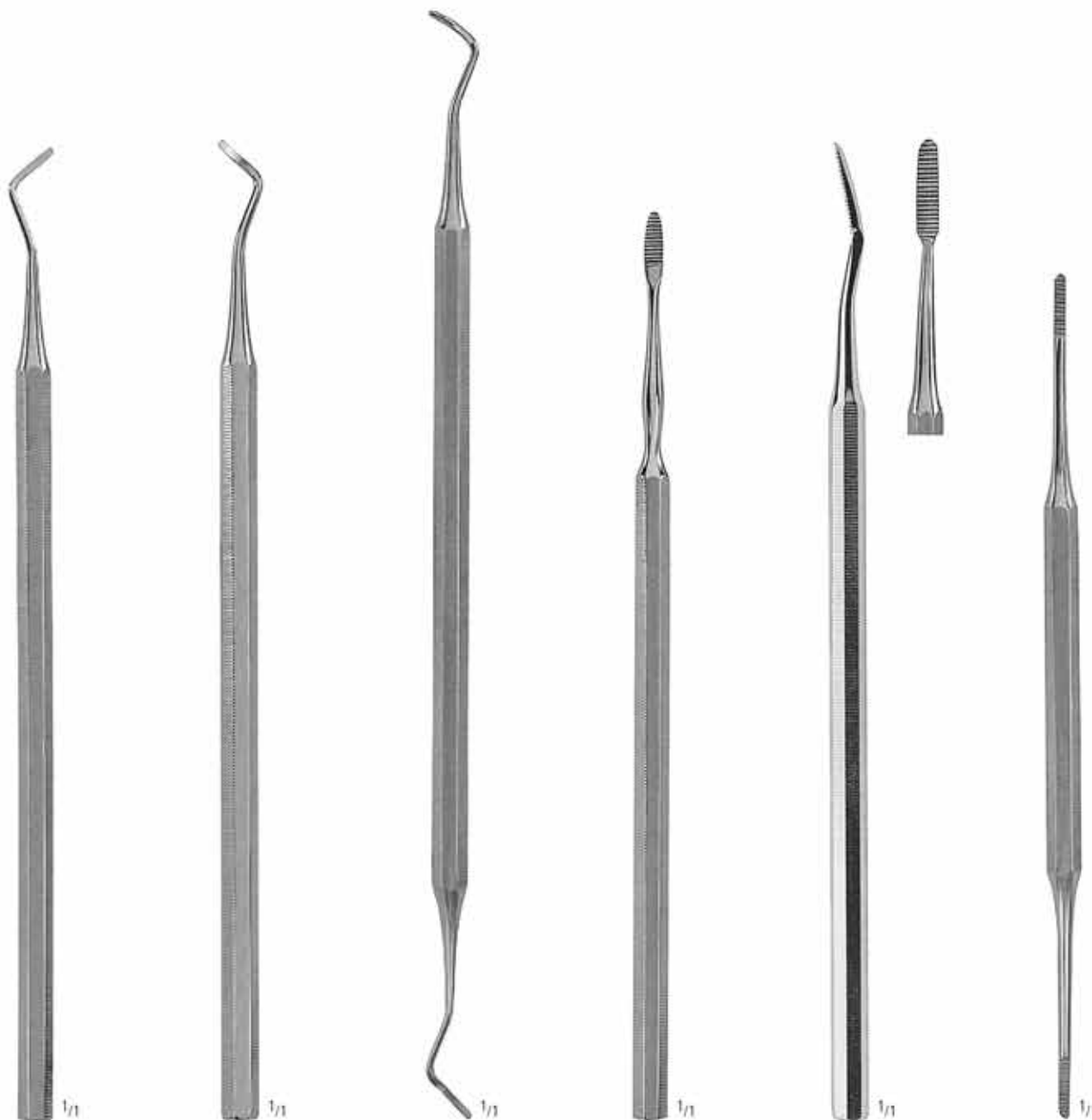

KU 860/01
15,0 cm/6"

KU 860/02
15,0 cm/6"

KU 862/17
17,0 cm/6³/₄"

KU 863/14
14,0 cm/5¹/₂"

KU 864/16
15,5 cm/6"

KU 865/14
14,0 cm/5¹/₂"



KU 866/13
13,0 cm/5"

KU 866/15
15,0 cm/6"



KU 867/16
16,0 cm/6 1/4"



KU 868/16
16,0 cm/6 1/4"



KU 869/16
16,0 cm/6 1/4"



KU 870/15
15,0 cm/6"



AA
AB
AC
AD
AE
AF
AK
AL
AM
AO
AP
AR
KA
KD
KY

KU



KU 872/15
15,5 cm/6"



KU 873/16
16,0 cm/6¹/₄"

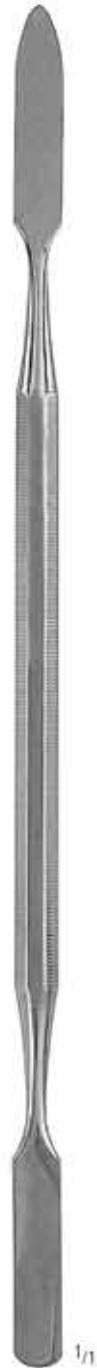

KU 874/18
18,0 cm/7"



KU 876/20
Ø 1,5 mm + 2,0 mm
14,5 cm/5³/₄"



KU 876/25
Ø 1,5 mm + 2,5 mm
14,5 cm/5³/₄"



KU 878/01
13,0 cm/5"

Nagel-Feilen
 Nail-files
 Limas de uñas
 Limes à ongles
 Lime per le unghie



KU 891/10
 10,0 cm/4"



KU 892/12
 11,5 cm/4 1/2"



KU 894/15
 15,0 cm/6"



KU 896/00

AA

AB

AC

AD

AE

AF

AK

AL

AM

AO

AP

AR

KA

KD

KU

KY

REINIGUNGSBÜRSTEN
CLEANING BRUSHES
CEPILLOS DE LIMPIEZA
BROSSES POUR NETTOYER
SPAZZOLI PER PULIRE

KY

nopa[®] instruments





STERILISATION STERILIZATION ESTERILIZACION STERILISATION STERILIZZAZIONE

Reinigungsbürsten
 Cleaning brushes
 Cepillos de limpieza
 Brosses pour nettoyer
 Spazzoli per pulire

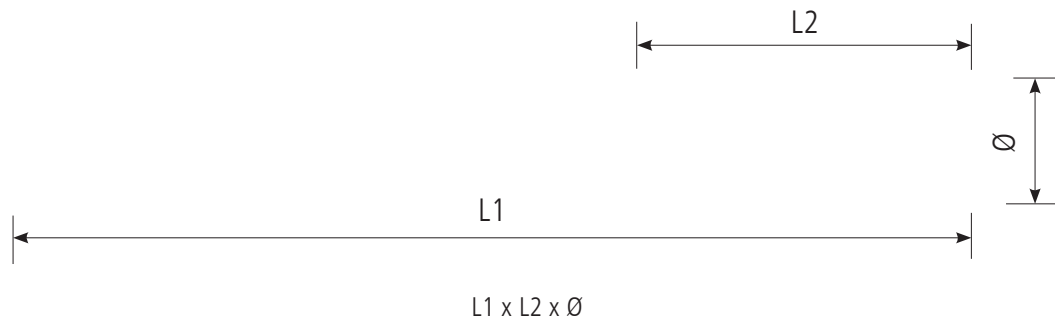

	1/2		
245 x 65 x 3 mm			KY 800/03
	1/2		
420 x 65 x 3 mm			KY 801/03
	1/2		
285 x 75 x 7 mm			KY 802/07
	1/2		
270 x 65 x 8 mm			KY 803/08

AA

AB

AC

AD

AE

AF

AK

AL

AM

AO

AP

AR

KA

KD

KU

KY

Reinigungsbürsten
Cleaning brushes
Cepillos de limpieza
Brosses pour nettoyer
Spazzoli per pulire

270 x 65 x 12 mm	¹ / ₂	KY 803/12
215 x 60 x 13 mm	¹ / ₂	KY 803/13
215 x 70 x 15 mm	¹ / ₂	KY 803/15
215 x 65 x 20 mm	¹ / ₂	KY 803/20
215 x 65 x 25 mm	¹ / ₂	KY 803/25
215 x 65 x 30 mm	¹ / ₂	KY 803/30

STERILISATION STERILIZATION ESTERILIZACION STERILISATION STERILIZZAZIONE

Reinigungsbürsten
 Cleaning brushes
 Cepillos de limpieza
 Brosses pour nettoyer
 Spazzoli per pulire

	1/2	KY 804/00 =	KY 805/13 KY 805/15 KY 805/20 KY 805/25 KY 805/28	AA AB AC AD AE AF
215 x 60 x 13 mm	1/2		KY 805/13	AK
215 x 65 x 15 mm	1/2		KY 805/15	AL AM
215 x 95 x 20 mm	1/2		KY 805/20	AO AP
215 x 95 x 25 mm	1/2		KY 805/25	AR KA
215 x 100 x 28 mm	1/2		KY 805/28	KD KU

KY

Reinigungsbürsten
Cleaning brushes
Cepillos de limpieza
Brosses pour nettoyer
Spazzoli per pulire

 $\frac{1}{2}$

275 x 65 x 12 mm

KY 806/12 $\frac{1}{2}$

275 x 80 x 15 mm

KY 806/15 $\frac{1}{2}$

300 x 120 x 30 mm

KY 806/30 $\frac{1}{2}$

320 x 130 x 50 mm

KY 806/50 $\frac{1}{2}$

360 x 140 x 35 mm

KY 807/35 $\frac{1}{2}$

420 x 180 x 40 mm

KY 808/40

STERILISATION STERILIZATION ESTERILIZACION STERILISATION STERILIZZAZIONE

Reinigungsbürsten
 Cleaning brushes
 Cepillos de limpieza
 Brosses pour nettoyer
 Spazzoli per pulire

500 x 180 x 60 mm

KY 809/60

1/2

490 x 180 x 80 mm

KY 810/80

1/2

450 x 180 x 60 mm

KY 811/60

420 x 130 x 75 mm

KY 812/75

AA
 AB
 AC
 AD
 AE
 AF
 AK
 AL
 AM
 AO
 AP
 AR
 KA
 KD
 KU
KY

Reinigungsbürsten
Cleaning brushes
Cepillos de limpieza
Brosses pour nettoyer
Spazzoli per pulire

330 x 130 x 50 mm ^{1/2} **KY 813/50**

400 x 190 x 8/20 mm ^{1/2} **KY 814/20**

300 x 110 x 18/33 mm ^{1/2} **KY 815/33**

320 x 70 x 15/25 mm ^{1/2} **KY 816/25**

420 x 60 x 8/15 mm ^{1/2} **KY 817/15**

STERILISATION STERILIZATION ESTERILIZACION STERILISATION STERILIZZAZIONE

Reinigungsbürsten
 Cleaning brushes
 Cepillos de limpieza
 Brosses pur nettoyer
 Spazzoli per pulire

AA

AB

AC

AD

AE

AF

AK

AL

1/2

1000 x 180 x 16 mm

KY 818/16

AM

AO

AP

AR

1/2

210 x 95 mm

KY 819/95

KA

KD

KU

KY

Reinigungspistole
 Spray gun
 Pistola lavatoria
 Pistolet laveur
 Pistola lavatrice

KY 940/01

KY 940/00

Reinigungspistole und Ansatzset komplett KY 940/01 + KY 945/00
 Spray gun and set of attachment complete KY 940/01 + KY 945/00
 Pistola lavatoria y set de toberas completo con KY 940/01 + KY 945/00
 Pistolet laveur et set d'embouts complet avec KY 940/01 + KY 945/00
 Pistola lavatrice e set di to raccordi completo con KY 940/01 + KY 945/00

Die nopa Reinigungspistole ist das ideale Werkzeug für die Reinigung von Laborgläsern, Pipetten, Spritzen, Kathetern, Küvetten, Endoskopen, Cystoskopen, Kanülen und anderen Gegenständen in Klinik, Labor und Praxis – also überall dort, wo es auf höchste Sauberkeit und Hygiene ankommt.

Die Reinigung erfolgt mit Wasser oder Druckluft besonders schnell, effizient und damit kostensparend.

Bei der neuen nopa Reinigungspistole ist der Wasser- oder Luftstrahl durch eine neuartige Dosiermechanik stufenlos über die gesamte Betätigungsstrecke des Abzughahns fein dosierbar.

Der maximale Wasser- oder Luftfluss kann auch mit der kleinen Rändelschraube hinter dem Abzughahn individuell eingestellt werden.

The nopa Spray Gun is the ideal instrument for cleaning laboratory glassware, pipettes, syringes, catheters, cuvettes, endoscopes, cystoscopes, cannulae and a variety of other instruments and articles used in clinics, laboratories, and medical practices – in other words, everywhere where highest cleanliness and hygiene are mandatory.

The nopa Spray Gun uses either water or pressurized air – this means the cleaning process is quick, efficient and inexpensive.

The nopa Spray Gun features a new type of internal flow control mechanism. It permits the smooth and simple adjustment of the water or air flow across the entire range of the trigger movement.

The desired maximum water or air flow can be set by using the small knurled screw located behind the trigger. It is then regulated via the triggerup to the set maximum value.

Reinigungspistole
 Spray gun
 Pistola lavatoria
 Pistolet laveur
 Pistola lavatrice

AA

AB

AC

AD

AE

AF

AK

AL

AM

AO

AP

AR

KA

KD

KU

Fig.1 Fig.2 Fig.3 Fig.4 Fig.5 Fig.6 Fig.7 Fig.8
KY 945/01 KY 945/02 KY 945/03 KY 945/04 KY 945/05 KY 945/06 KY 945/07 KY 945/08

**KY 945/00 = KY 945/01
 KY 945/02
 KY 945/03
 KY 945/04
 KY 945/05
 KY 945/06
 KY 945/07
 KY 945/08**

- >> Spülen, Saugen und Trocknen für die unterschiedlichsten Einsatzgebiete wird durch ein Sortiment von 8 Ansätzen ermöglicht.
- >> Das Standard-Set mit 8 Ansätzen wird auf einer stabilen Aufsteckleiste für die Wandmontage geliefert. Damit ist jedes Einzelteil sicher und griffbereit aufbewahrt.

- >> Rinsing, suction or drying in every area of application is made possible through the set of 8 attachments.
- >> The standard set of 8 attachments is delivered on a stable storage rack for mounting on the wall. All attachments are kept within easy reach.

KY



Inhaltsverzeichnis

	Seite		Seite
A		B	
Abszessmesser	174	BABCOCK , Darmfasszangen	9, 519
ADAMS-MAYO , selbsthaltende Wundsperrerr	296	BABINSKY , Perkussionshammer	369
ADISON , Schutzzange	390	BABY KOCHER , Atraumatische Magen- und Darmklemmen	526
ADLERKREUTZ , Pinzetten	65	BABY-ADSON , Arterienklemmen	25
ADSON , selbsthaltende Wundsperrerr	290, 291	BABY-ADSON , selbsthaltende Wundsperrerr	292
ADSON , Arterienklemmen	25	BABY-BALFOUR , Bauchdeckenhalter	299
ADSON , Elevatorien	449	BABY-COLLIN , Bauchdeckenhalter	304
ADSON , Hartmetallpinzetten TUC	93	BABY-CRILE-WOOD , Hartmetallnadelhalter TUC	196
ADSON , Nadelhalter	183	BABY-CRILE-WOOD , Nadelhalter	182
ADSON , Pinzetten	59, 60	BABY-DOYEN , Magen- und Darmklemmen	520
ADSON , Saugrohre	335	BABY-KOCHER , Magen- und Darmklemmen	521, 526
ADSON-ANDERSON , selbsthaltende Wundsperrerr	290	BABY-LEXER , Präparierschere	111
ADSON-BABY , Arterienklemmen	25	BABY-LIGHTWEIGHT-DUPLEX , Stethoskop	378
ADSON-BABY , selbsthaltende Wundsperrerr	292	BABY-METZENBAUM , Präparierschere	108
ADSON-BECKMANN , selbsthaltende Wundsperrerr	293	BABY-MIKULICZ , Peritoneumklemme	49
ADSON-BROWN , Pinzetten	60	BABY-MIXTER , Präparier- und Ligaturklemmen	33
ADSON-MICRO , Pinzetten	59	BABY-OVERHOLT , Präparier- und Ligaturklemme	23
ADSON-TOENNIS , Gefäßscheren	116	BABY-POOLE , Saugrohre	332
ADSON-TOENNIS-DELICATE , Hartmetallscheren TUC	161	BABY-SENN-MILLER , feine Wundhaken	250
ADVENTITIA , Mikroscheren	145, 147	BABY-WEITLANER , selbsthaltende Wundsperrerr	287
Akku / Ladegeräte	393	BACKHAUS , Tuchklemmen	52
Akku Bohraparat	391	BACON , Hohlmeißelzangen	470
ALAN PARKS , Anuskope	537	BAINBRIDGE , Arterienklemmen	27
ALDERDYCE , Elevatorien	448	BAINBRIDGE , Atraumatische Magen- und Darmklemmen	524
ALEXANDER , Meißel	418	BALFOUR , Bauchdeckenhalter	299, 300
ALEXANDER , Raspatorien	446	BALFOUR-BABY , Bauchdeckenhalter	299
ALLIS , Fasszängchen	517	BALFOUR-US-TYPE , Bauchdeckenhalter	299
ALLIS , Gewebefasszängchen	9	BALL & SOCKET , Tuchklemmen	52
ALLIS-ADAIR , Fasszängchen	517	BALLANTINE-HEANEY , Hysterektomieklemmen	43
ALLIS-BABY , Fasszängchen	517	BALLENGER-FOERSTER , Schwammzangen	237
ALM , selbsthaltende Wundsperrerr	283	BARRAQUER , Cilienpinzetten	76
ALY , Sensibilitätsinstrument	376	BARRAQUER , Iridektomieschere	138
Ampullenspritzen	347	BARRAQUER , Mikronadelhalter	206
Amputations- und Resektionssägen	384	BARRAQUER , Vorderkammer-Pinzetten	85
Amputationsmesser	172	BARRAQUER-KATZIN (COLIBRI) , Iripinzetten	82
Amputationsschild	463	BARRAQUER-KATZIN , Hornhautscheren	142
Anastomosenklemmen	528, 529, 532, 533	BARRAQUER-TROUTMAN , Mikronadelhalter	206
Anatomiescheren	118	BARRAYA-STILLE , Pinzetten	65
ANDERSON-ADSON , selbsthaltende Wundsperrerr	290	Bauchdeckenhalter	298-307
ANDREWS-PYNCHON , Saugrohre	331	Bauchdeckenscheren	106
Anlegezangen	11	Bauchspatel	308
Anuskope	537-543	BAUMGARTNER , Nadelhalter	184
ANVIL , Nagelspaltzange	571	BECK-LUETHY , Hartmetallnadelhalter TUC	202
ARLT-FISCHER , Iripinzetten	80	BECKMANN , selbsthaltende Wundsperrerr	292
ARRUGA , Hartmetallnadelhalter TUC	201	BECKMANN-ADSON , selbsthaltende Wundsperrerr	293
ARRUGA , Kapselpinzetten	83	BECKMANN-EATON , selbsthaltende Wundsperrerr	293
ARRUGA , Mikronadelhalter	212	BEEBEE , Kronenscheren	130, 131
ARRUGA , Nadelhalter	180	BEER , Cilienpinzetten	76
ARRUGA-KALT , Mikronadelhalter	212	BEESON , Gipsspreizer	319
Arterienklemmen	13-23, 25-28	BENGOLEA , Arterienklemmen	28
Arterienklemmen, grazil	22	BENSAUDE , Anuskope	540
Arthroskopie	408-415	BERENS , Muskelpinzetten	88
Artikulationspapierpinzetten	98	BERGMANN , Gipssäge	318
Atraumatische Magen- und Darmklemmen	524-527	BERGMANN , Hämmer	427
Atraumatische Pinzetten	91	BERGMANN , Verbandscheren	132
Augenscheren	125-127, 138-143	BERKE , Chalazionpinzetten	89
Aurikelklemmen	29	BERLINER , Perkussionshammer	370
AUSTIN , Knüpfpinzetten	71	BERNHARD , Tuchklemmen	51
AUSTRALIA , Fingerwundspreizer	283	Besteck, Diagnostik-	380, 381
AUSTRALIA , Wundspreizer für die Handchirurgie	285	Besteck, Krampfader-	312
Autopsie-Säge	483-485	BEYER , Hohlmeißelzangen	471
AYER , Chalazionspinetten	88	BILLROTH , Wundhaken	252
		BINKHORST , Kapselpinzetten	83

	Seite		Seite
Biopsiekanülen	343, 344	CARMALT-WALTER , Splitterpinzetten	73
BIRCHER , Meniskotome	467	CAROLL , Goniometer	373
BIRCHER-GANSKE , Knochenhaltezeugen	453	CAROLL , Sehnenfassinstrumente	464
BIRKETT , Präparier- und Ligaturklemmen	41	CARREL , Arterienklemme	14
BISHOP-HARMAN , Irispinzetten	82	CARROLL , Hartmetallnadelhalter TUC	194
BLASCOVICS , Muskelpinzetten	87	CARROLL , Nadelhalter	182
Bleihände	482	CARTILAGE-MARTIN , Scheren	118
BLOND , Anuskope	542, 543	CASTROVIEJO , Fixierpinzetten	84
BLOUNT , Knochenhebel	398	CASTROVIEJO , Hartmetallmikronadelhalter TUC	204, 205
BLOUNT , Meniskushaken	466	CASTROVIEJO , Hornhautscheren	138
BLUEPOWER , elektrische Gipsäge	322	CASTROVIEJO , Hornhautscheren	141
BLUMENTHAL , Hohlmeißelzangen	469	CASTROVIEJO , Iridektomiescheren	138
Blutdruckmessapparate	379	CASTROVIEJO , Kapselpinzetten	83
BÖHLER , Extensionsbügel	399	CASTROVIEJO , Klängenbrecher	177
BÖHLER , Hohlmeißelzangen	471	CASTROVIEJO , Mikronadelhalter	210, 213
Bohrdrähte	499-502	CASTROVIEJO , Nahtpinzetten	85
BOLEY , Schieblehre	373	CASTROVIEJO , Zirkel	375
BONACCOLTO , Nahtpinzetten	85	CASTROVIEJO-EPKER , Zirkel	375
BONN MOD. , Nahtpinzetten	86	CASTROVIEJO-KALT , Mikronadelhalter	212
BONNEY , Fasspinzetten	68	CATLIN , Amputationsmesser	172
BONNEY , Hartmetallpinzetten TUC	94	CHADWICK , Augenscheren	126
Boomerang Nadelhalter	189	Chalazionspinzetten	88, 89
BÖTTCHER , Tonsillenscheren	119	CHAPUT , Fasszangen	12
BOYNTON , Hartmetallnadelhalter TUC	201	CHARRIERE , Amputationssägen	384
BOYNTON , Nadelhalter	180	CHEATLE , Sterilisierzangen	564
BOYS-ALLIS , Fasszängchen	518	CHERON , Tupferzangen	234
BOZEMANN , Hartmetallnadelhalter TUC	197	CHILDE , Wundklammerpinzetten	225
BOZEMANN , Nadelhalter	182	Chirurgische Scheren	102-105, 122
BOZEMANN , Nahtinstrumente	223	CHRIS-TROUTMAN , Klängenbrecher	177
BOZEMANN , Tupferzangen	233	CHURCH , Gefäßscheren	117
BOZEMANN-DOUGLAS , Tupferzangen	233	Cilienpinzetten	76
BRAND , Sehnenfassinstrumente	464	CLAR 55 , Stirnlampen	368
BRAUN-STADLER , Episiotomiescheren	121	CLAR STANDARD , Stirnlampen	368
BRIDGE , Präparier- und Ligaturklemmen	34	CLASSON , Gefäßscheren	117
BRODIE , Sonden	311	CLAUS , Unterbindungsnadeln	218
Bronchusklemmen	30	CLAUS-EICKEN , Unterbindungsnadeln	219
BROPHY , Pinzetten	63	CLEVELAND , Hohlmeißelzangen	468
BROPHY-SULLIVAN , feine Scheren	123	CLEVELAND , Knochensplitterzangen	478
BROWN , Nadelhalter	183	CLEVELAND-GARDNER , Knochensplitterzangen	477
BROWN , Pinzetten	64	CLOWARD HIBBS SPRATT , scharfe Löffel	437
BROWN-ADSON , Pinzetten	60	COAKLEY , Trokare	330
BROWNE-DENIS , Bauchdeckenhalter	301	COBB , Elevatorien	449
BRUNNER , Führungshohlsonden	220	COBB , Meißel	424
BRUNNER , Magen- und Darmklemmen	520	COBB , scharfe Löffel	439
BRUNNER , Unterbindungsnadeln	216, 217	COGSWELL , Saugrohre	336
BRUNNER , Wundhaken	263	COLIBRI (BARRAQUER-KATZIN) , Irispinzetten	82
BRUNNER-FERROZELL , Führungshohlsonden	222	COLLEGE-LONDON , Zahnpinzetten	95
BRUNS , Gipscheren	134	COLLER , Arterienklemmen	17
BRUNS , scharfe Löffel	434, 437	COLLIER , Nadelhalter	180
BRYANT , Schwammzange	228	COLLIN , Amputationsmesser	172
BUCK , Ligaturscheren	129	COLLIN , Bauchdeckenhalter	304, 305
BUCK , Perkussionshammer	369	COLLIN , Dynamometer	374
BUELAU , Trokare	328	COLLIN , Fasszange	13
Bulldogklemmen	10, 11	COLLIN , Hämmer	429
BUNNELL , Handbohrapparate	388	COLLIN , Skalpelle	170
BUNNELL , Sehnenstripper	465	COLLIN , Skalpellgriffe	166
BUSCH , Nabelschnurscheren	121	COLLIN , Tupferzangen	234
BYRD , Saugrohre	332	COLLIN , Wundklammerzängchen	224
COLLIN-BABY , Bauchdeckenhalter	304	COLLIN-DUVAL , Fasspinzette	66
COLLIN-HARTMANN , Wundhaken	277	COLLIN-DUVAL , Fasspinzette	66
CONE , selbsthaltende Wundsperrer	292	CONVERSE , Hartmetallnadelhalter TUC	195
CONVERSE , Hartmetallnadelhalter TUC	195	CONVERSE-DERF , Nadelhalter	180
CONVERSE-DERF , Nadelhalter	180	COOLEY , Gefäßdilatoren	313
COOLEY , Gefäßdilatoren	313	COOLEY , Saugrohre	333
COOLEY , Saugrohre	333	COOPER , Unterbindungsnadeln	216
COOPER , Unterbindungsnadeln	216	CORNEAL (TROUTMAN) , Irispinzetten	82
CORNEAL (TROUTMAN) , Irispinzetten	82	Coronarscheren	115
CORNEAL (TROUTMAN) , Coronarscheren	115		

	Seite		Seite
CORWIN , Drahtzangen TUC	403	DERF-CONVERSE , Nadelhalter	180
CORWIN , Hartmetalldrahtzangen TUC	203	Dermatome	176
CORYLLOS , Wundhaken	274	DESCHAMPS , Unterbindungsnadeln	215
COTTLE KAZANJIAN , Knochensplitterzangen	477	DESJARDINS , Gallenkanalklemmen	40
COTTLE , Hämmer	428	DESMARRES , Chalazionspinzetten	88
COTTLE , Nasenpinzetten	77	DESMARRES , feine Wundhaken	248
COTTLE , Nasenscheren	120	Diagnostik	367-382
COUPLAND , Saugrohre	332	Diagnostikbestecke	380, 381
COUPLAND , Saugrohre	337	DICK , Anastomosenklemmen	528
CRAFOORD , Bronchusklemme	30	DIEFFENBACH , Abszessmesser	174
CRAFOORD , Scheren	118	DIEFFENBACH , Bulldogklemmen	11
CRAFOORD-SELLORS , Aurikelklemmen	29	DIEFFENBACH , Skalpelle	170, 171
CRANE-KAPLAN , Markierungspinzetten	98	DIETHRICH , Hartmetallmikronadelhalter TUC	205
CREGO , Knochenhebel	398	DIETHRICH-HEGEMANN , Gefäßscheren	114
CRILE , Arterienklemmen	17	Dilatatoren, Gefäß-	313, 314
CRILE , Nadelhalter	187	DINGMANN , Knorpelfasszange	453
CRILE-MURRAY , Nadelhalter	182	DIPLOMAT , Blutdruckmessapparate	379
CRILE-RANKIN , Arterienklemmen	17	DISSECTION , Mikroscheren	145, 147
CRILE-WOOD , Hartmetallnadelhalter TUC	196	DIXON-LOVELACE , Arterienklemmen	26
CRILE-WOOD , Nadelhalter	182	DOUGLAS , Cilienpinzetten	76
CRILE-WOOD-BABY , Hartmetallnadelhalter TUC	196	DOUGLAS , Trokare	330
CRILE-WOOD-BABY , Nadelhalter	182	DOUGLAS-BOZEMANN , Tupferzangen	233
CULLEN-WERTHEIM , Hysterektomieklappen	44	DOYEN , Atraumatische Magen- und Darmklemmen	524
CUSHING , feine Wundhaken	244, 248	DOYEN , Bauchdeckenhalter	302
CUSHING , Flachbohrer	387	DOYEN , Hämmer	428
CUSHING , Hartmetallpinzetten TUC	93	DOYEN , Magen- und Darmklemmen	520, 524
CUSHING , Pinzetten	62	DOYEN , Nadelhalter	180
CUSHING , Spinalhaken	250	DOYEN , Raspatorien	445
CUSHING-TAYLOR , Hartmetallpinzetten TUC	93	DOYEN , Scheren	106
CZERNY , Mastdarm-Spekula	534	DOYEN , Sonden	310
CZERNY , Wundhaken	279	DOYEN , Tuchklemmen	51
		DOYEN , Wundhaken	267
D		DOYEN-STILLE , Wundhaken	266
DAHMEN , Meißel	425	Drahtscheren	130
DAHMEN , Osteotome	425	Drahtspanninstrumente	407
DANDY , Gefäßscheren	115	Drahtzangen	401-403, 405, 406
DANDY , Kopfhautklemmen	26	Drahtzangen mit Hartmetalleinsätzen TUC	203
DARLING , selbsthaltende Wundsperrer	295	Druckklemmen	47, 48
Darm- und Magenklemmen	520-523	DUBOIS , Gynäkologische Scheren	107
Darm- und Magenquetschklemmen	530	DUEHRSSSEN , Pinzetten	64
Darmfasszangen	9	DUNHILL , Arterienklemme	22
Darmfasszangen	517-519	DUPLAY , Kornzangen	236
Darmklemmen	532, 533	DUPLEX-LIGHTWEIGHT/BABY , Stethoskope	378
Darmscheren	118	DURANTE , Fasspinzetten	68
DAVIDSON , Wundhaken	276	DUVAL , Darmfasszangen	519
DAVIS-RAGNELL , feine Wundhaken	250	DUVAL , Fasspinzetten	68
DE BAKEY , Atraumatische Pinzetten	91	DUVAL-COLLIN , Fasspinzetten	66
DE BAKEY , Gefäßdilatoren	314	Dynamometer	374
DE BAKEY , Gefäßscheren	113, 116	DYNAMOMETER III	374
DE BAKEY , Hartmetallnadelhalter TUC	192		
DE BAKEY , Hartmetallpinzetten TUC	94	E	
DE BAKEY , Hartmetallscheren TUC	157	EASTMAN-RICHARDSON , Wundhaken	264
DE BAKEY , Saugrohre	331	EATON-BECKMANN , selbsthaltende Wundsperrer	293
DE LA ROZA , Unterbindungsnadeln	217	ECHLIN , Hohlmeißelzangen	474
DE MARTEL-POTTS , Gefäßscheren	116	ECONOM , Diagnostikbestecke	380
DE MARTEL-WOLFSON , Anastomosenklemmen	532, 533	EICKEN , Trokare	330
DE MARTEL-WOLFSON , Darmklemmen	532, 533	EICKEN-CLAUS , Unterbindungsnadeln	219
DEAN , Hartmetallscheren TUC	162	EICKEN-KILLIAN , Saugkanüle	335
DEAN , Zahnfleischscheren	136	EISELSBERG , Ligaturscheren	128
DEAN-DELICATE , Zahnfleischscheren	136	Elektrische Gipssäge	321, 322
DEAVER , Chirurgische Scheren	104	Elevatoren	447-449, 481
DEAVER , Wundhaken	269-271	ELSCHNIG , Fixierpinzetten	84
Deckglaspinzetten	78	ENGEL , Gipssäge	318
DEJERINE , Perkussionshammer	370	ENGLISCHES MODELL , Tuchklemmen	51
DEMEL , Drahtspanninstrumente	407	Entropiumpinzetten	88
DENIS BROWNE , Bauchdeckenhalter	301	Episiotomiescheren	121
DERF , Hartmetallnadelhalter TUC	195	ERHARDT , Entropiumpinzette	88
DERF , Nadelhalter	180	ESMARCH , Gipsmesser	318

	Seite		Seite
ESMARCH , Verbandsscheren	134	FRENCH-EYE-RYDER , Hartmetallnadelhalter TUC	193
EUFRATE PASQUE , Hartmetallnadelhalter TUC	193	FRIEDMAN , Hohlmeißelzangen	468
EWALD , Pinzetten	60	FRIEDMAN-MICRO , Hohlmeißelzange	476
EXCENTRIC-LISTER , Verbandscheren	133	FRIEDRICH , Nahtinstrumente	223
Extensionsbügel	399, 400	FRITSCH , Wundhaken	266
F		FRYKHOLM , Hohlmeißelzangen	474
Facelift Markierer	376	FUCHS-GILL , Irispinzetten	83
Face-Lift-Scheren TUC	161	Führungshohlsonden	220-222
Fadenfänger	223	Führungsnadeln	346
Fadenknoter	223	FULTON , Gefäßscheren	117
Fadenschlingendreher	223	Fußpflege	568-579
FALK , Unterbindungsnadeln	219	G	
FARABEUF , Knochenhaltezangen	458	Gallenkanalklemmen	37, 40
FARABEUF , Raspatorien	443	GARRETT , Gefäßdilatoren	313
FARABEUF , Wundhaken	278	Gefäßchirurgiescheren	113-117
FARABEUF-LAMBOTTE , Knochenhaltezangen	458	Gefäßdilatoren	72, 313, 314
FARRELL , Watteträger	311	Gefäßklemmen	12
Fasspinzetten	66-68, 70, 316	Gefäßstripper	315
Fasszangen	12, 13, 316	GEISSENDOERFER-OVERHOLT , Arterienklemmen	23
FAULKNER , Linsenhaltepinzette	90	GELPI , selbsthaltende Wundsperrerr	294
FAURE , Hysterektomieklappen	45	GEMINI , Präparier- und Ligaturklappen	35
FAURE , Peritoneumklappen	50	GERALD , Pinzetten	62
FAVALORO , Gefäßscheren	115	GERSTER , Knochenhalteklappen	394
FEHLAND , Atraumatische Magen- und Darmklappen	527	GERSTER-LOWMAN , Knochenhalteklappen	394
FEILCHENFELD , Splitterpinzetten	73	Gewebefasszängchen	9
FEIN , Watteträger	312	Gewebefasszängchen	517, 518
Feine Arterienklappen	15	GILL , Kapselpinzetten	83
Feine Scheren	124	GILL-FUCHS , Irispinzetten	83
Feine Wundhaken	242-250	GILL-HESS , Irispinzetten	82
FERGUSON , Chirurgische Scheren	104	GILLIES , feine Wundhaken	242
FERGUSON , Druckklappen	47	GILLIES , Hartmetallnadelhalter TUC	198
FERGUSON , Knochenhaltezangen	455	GILLIES , Hartmetallpinzetten TUC	92
FERGUSON , Saugrohre	335	GILLIES , Nadelhalter	185
FERREIRA , Wundhaken	280	GILLIES , Pinzetten	67
FERRIS-SMITH , Pinzetten	65	GILLS-WELSH , Kapsulotomieschere	140
FERROZELL , Führungshohlsonden	222	GIL-VERNET , feine Wundhaken	249
FERROZELL-BRUNNER , Führungshohlsonden	222	Gipsabreisszange	320
FERROZELL-KIRSCHNER , Führungshohlsonden	222	Gipsmesser	318
FIBRE OPTIC , Kaltlichtlaryngoskope	360	Gipssäge	318
Fingerringssägen	482	Gipssäge, elektrisch	321, 322
Fingerwundspreizer	283	Gipsschere	134
FINOCCHIETTO , Hartmetallnadelhalter TUC	197	Gipsscheren	320
FINOCCHIETTO , Nadelhalter	185	Gipsspreizer	319
FINOCCHIETTO , Nierenstielklappen	37	Gipstrephine	318
FINOCCHIETTO , Scheren	118	GOELET , Wundhaken	279
FINSEN , selbsthaltende Wundsperrerr	283	GOLDMAN-FOX SPEZIAL , Zahnfleischeren	136
FISCHER-ARLT , Irispinzetten	80	GOLDMAN-FOX , Hartmetallscheren TUC	161
Fistelmesser	174	GOLDMAN-FOX , Zahnfleischscheren	136
Fistelscheren	106	Goniometer	373
Fixierpinzetten	84	GOOD , Tonsillenscheren	119
Flachzangen	404	GOOD-SCHWECKENDICK , Tonsillenscheren	119
FLAGG , Zahnpinzetten	96	GORNEY , Präparierscheren	111
FLETCHER , Schwammzangen	232	GOSSET , Bauchdeckenhalter	298
FOERSTER , Irispinzetten	81	GRADLE , Cilienpinzetten	76
FOERSTER-BALLENGER , Schwammzangen	237	GRAEFE , Augenscheren	126
FOMON , Nasenscheren	119	GRAEFE , feine Wundhaken	243
FOMON , Präparierscheren	111	GRAEFE , Fixierpinzetten	84
FOREGGER-WISCONSIN FIBRE OPTIC , Laryngoskope	358	GRAEFE , Irispinzetten	79
FOREGGER-WISCONSIN , Laryngoskope	354	GRAY , Gallenkanalklappen	40
FOX , scharfe Löffel	436	GRAZIL , Chirurgische Scheren	103
FOX-GOLDMAN SPEZIAL , Zahnfleischscheren	136	Grazile Arterienklappen	22
FOX-GOLDMAN , Zahnfleischscheren	136	GREEN , Fixierpinzetten	84
FRANKENFELDT , Fasszange	316	GREEN-SENN , feine Wundhaken	247
FRANZ , Bauchdeckenhalter	302	GROSS-MAIER , Kornzangen	230, 231
FRAZIER , feine Wundhaken	242	GRUENWALD , Nasenpinzetten	78
FRAZIER , Saugrohre	335	GRUENWALD-JANSEN , Nasenpinzetten	78
FREER , Elevatorien	448	GUTHRIE , feine Wundhaken	246

	Seite		Seite
GUYON , Nierenstielklemmen	38, 39	HOLINGER , Laryngoskope	362
GUYON-ARTRAUMATIC , Nierenstielklemmen	39	HOPKINS , Gipsmesser	318
Gynäkologische Scheren	105-107	HOPKINS-JOHNS , Anlegezangen	11
H		HOPKINS-JOHNS , Bulldogklemmen	11
HABERER , Bauchspatel	308	HOPKINS-JOHNS , Präparier- und Ligaturklemmen	32
Hähne	349	HORNE-JOBSON , Watteträger	312
HAJEK , Hämmer	429	Hornhautscheren	141-143
Haken, Spinal-	250	HÖSEL , Hartmetallnadelhalter TUC	201
Haken, Wund-	242-308	HÖSEL , Nadelhalter	188
HALLE , Nasenscheren	120	HOSPITAL-PROVIDENCE , Arterienklemmen	16
HALSEY , Hartmetallnadelhalter TUC	195	HRYNTSCHAK-YOUNG , Nadelhalter	189
HALSEY , Nadelhalter	181	HUDSON , Handbohrapparate	387
HALSTED , Arterienklemmen	16	HUMBY , Dermatome	176
HALSTED-MOSQUITO , Arterienklemmen	15	HUNT , Pinzetten	70
Halter, Bauchdecken-	298-307	HUNTER , Splitterpinzetten	73
Hämmer	427-433	HURD , Unterbindungsnadeln	218
Hämmer, Perkussions-	369, 370	Hysterektomieklappen	41-45
Hämorrhoidal-Ligatoren	552-554	I	
Hämorrhoidenklappen	47, 48	Instrumentarium für Küntscher-Nägel	488, 489
Hämorrhoidenklappen, atraumatisch	48	Instrumente, Mess-	371-375
Handbohrapparate	385-390	Instrumente, Sensibilitäts-	376
Handgriffe für Liposuktions- und Infiltrationskanülen	338, 340	Instrumentenablageplatten	561
HARMAN-BISHOP , Irispinzetten	82	Instrumentenkästen	562
HARMS , Nahtpinzetten	86	Inzisionsscheren	104
HARRINGTON , Wundhaken	267	IOWA , Spezialkanülen	345
HARRINGTON-MAYO , Scheren	105	Iridektomiescheren	138
HARRISON (PYE-SMITH) , Sterilisierzange	564	Irispinzetten	79-82
HARTMANN , Arterienklemme	14	Irisscheren	125, 138
HARTMANN , Hohlmeißelzangen	469	ISRAEL , Wundhaken	253
Hartmetalleinsatzplättchen mit Pyramidenprofil	190, 191	IVES-FANSLER , Sphinkteroskope	538
HARVEY , Drahtscheren	130	IWANSON , Zirkel	375
HATFIELD , scharfe Löffel	439	J	
Hautscheren	135	JACKSON , Kaltlichtlaryngoskope	363
HEANEY , Hysterektomieklappen	43	JACKSON , Tamponpinzetten	78
HEANEY , Nadelhalter	184	JACOBI , Unterbindungsnadeln	217
HEANEY , Wundhaken	277	JACOBS CHUCK , Handbohrapparate	388
HEANEY-BALLANTINE , Hysterektomieklappen	43	JACOBSON , Hartmetallmikronadelhalter TUC	204
HEANEY-KANTER , Hysterektomieklappen	43	JACOBSON , Hartmetallnadelhalter TUC	194
HEANEY-REZAK , Hysterektomieklappen	44	JACOBSON , Mikronadelhalter	210
HEATH , Ligaturscheren	129	JACOBSON , Nadelhalter	182
HEATH-RICHTER , Wundklammerzängchen	224	JAMESON , Muskelpinzetten	87
HEGAR-OLSEN , Hartmetallnadelhalter TUC	198	JAMESON , Nadelhalter	184
HEGAR-OLSEN , Nadelhalter	185	JAMESON , Schieblehre	372
HEGEMANN-DIETHRICH , Gefäßscheren	114	JANET , Spritzen	348
HEGENBARTH , Wundklammerpinzetten	224	JANSEN , Nasenpinzetten	77
HEIFETZ , Pinzetten	70	JANSEN , scharfe Löffel	440
HEISS , Arterienklappen	30	JANSEN , selbsthaltende Wundsperrer	284
HELFERICH-BIER , Amputationssägen	384	JANSEN-GRUENWALD , Nasenpinzetten	78
HEMINGWAY , scharfe Löffel	441	JEWELER , Hartmetallpinzetten TUC	92
HENAHAN , Wiesheitszahnhaken	481	JOBSON-HORNE , Watteträger	312
HENLEY , selbsthaltende Wundsperrer	288	JOHANSSON , Trokare	329
HENNIG , Gipsspreizer	319	JOHNS HOPKINS , Präparier- und Ligaturklemmen	32
HERRICK , Nierenstielklemmen	39	JOHNS-HOPKINS , Anlegezangen	11
HESS , Irispinzetten	81	JOHNS-HOPKINS , Bulldogklemmen	11
HESSBERG , Unterbindungsnadeln	217	JONES , Tuckklemmen	51
HESS-GILL , Irispinzetten	82	JOSEPH , feine Wundhaken	246
HEYMANN , Nasenscheren	120	JOSEPH , Präparierscheren	112
HEYWOOD-SMITH , Schwammzangen	236	JUDD-ALLIS , Faszszangen	518
HIBBS , Meißel	420	K	
HIBBS , Osteotome	420	KADER , Wundhaken	273
Hirnmesser	173	KALT , Hartmetallmikronadelhalter TUC	205
HIRSCHMANN , Anuskope	539	KALT , Mikronadelhalter	212
HOEN , Elevatorien	448	KALT-ARRUGA , Mikronadelhalter	212
HOESEL , Wundhaken	265		
Hohlmeißelzangen	468-476		
HOHMANN , Knochenheber	396, 397		
HOKE , Osteotome	417		

	Seite		Seite
KALT-CASTROVIEJO , Mikronadelhalter	212	Knochenhalteklammern	394
Kaltlichtlaryngoskope	357-360	Knochenhaltezangen	452, 454-462
Kaltlichtträger	363	Knochenhebel	395-398
Kamm	564	Knochenschrauben	505-512
KANTER-HEANEY , Hysterektomieklammern	43	Knochensplitterzangen	477-480
KANTROWITZ , Präparier- und Ligaturklammern	35	Knorpelscheren	118
Kanülen, Biopsie-	343, 344	KNOWLES , Verbandscheren	133
Kanülen, Spezial-	345	Knüpfpinzetten mit Plateau	71, 72
KAPLAN-CRANE , Markierungspinzetten	98	KOCHER , Atraumatische Magen- und Darmklammern	525
Kapselpinzetten	83	KOCHER , Führungshohlsonden	222
Kapsulorhexispinzetten	90	KOCHER , Magen- und Darmklammern	522, 525
Kapsulotomiescheren	140	KOCHER , Unterbindungsnadeln	216
Katheterzangen	361	KOCHER , Wundhaken	260, 266
KATZIN , Hornhautscheren	142	KOCHER , Wundhaken	251, 260, 266
KATZIN-BARRAQUER , Hornhautscheren	142	KOCHER-DELICATE , Arterienklammern	22
KAYE , Face-Lift-Scheren TUC	161	KOCHER-LANGENBECK , Wundhaken	259
KELLY , Arterienklammern	17	KOCHER-OCHSNER , Arterienklammern	20, 21
KELLY , Fistelscheren	106	KOERTE , Wundhaken	252, 267
KELLY , Hartmetallschere TUC	153	KÖNIG , Führungshohlsonden	221
KELLY , Proktoskope	540, 541	KÖNIG , Nagelspaltscheren	135
KELLY , Schwammzangen	235	Kopfhautklammern	12, 26
KELLY , Wundhaken	268	Kornzangen	229-239
KELLY-RANKIN , Arterienklammern	17	Krampfaderbesteck	312
KELLY-RICHARDSON , Wundhaken	264	KRAUSE , Trokare	330
KELMAN-McPHERSON , Nahtpinzetten	85	KROENLEIN , Fasszange	13
KERN , Knochenhaltezangen	456	KRONECKER , Unterbindungsnadeln	218
KERSTING , Anastomosenklammern	528	Kronenscheren	130, 131
KILNER , feine Wundhaken	242	Kropfscheren	119
KILNER , Hartmetallnadelhalter TUC	195	KUEHNE , Deckglaspinzetten	78
KILNER , Nadelhalter	181	KÜNTSCHER , Instrumentarium für Nägel	488, 489
KILNER-RAGNELL , Präparierscheren	112	KÜNTSCHER , Nägel	492-494
KIRBY , Irispinzetten	82	Küretten	434-441
KIRSCHNER , Bauchdeckenhalter	303	KUTZ-KLEINERT , feine Wundhaken	242
KIRSCHNER , Bohrdrähte	499-502		
KIRSCHNER , Extensionsbügel	400	L	
KIRSCHNER , Führungshohlsonden	222	LA GRANGE , Augenscheren	126
KIRSCHNER , Saugrohre	503	LAHEY , Gallenkanalklammern	37
KIRSCHNER-FERROZELL , Führungshohlsonden	222	LAHEY , Wundhaken	263
Klammern	496	LAMBOTTE , Knochenhaltezangen	460
Klammern, Wund-	225	LAMBOTTE , Osteotome	426
Kleiderscheren	132, 133	LAMBOTTE , Raspatorien	443
KLEINERT-KUTZ , feine Wundhaken	242	Lampen, Stirn-	368
KLEINERT-KUTZ , Hohlmeißelzangen	471	LAMPERT , Chalazionpinzette	89
KLEINERT-KUTZ , Sehnenfassinstrumente	464	LANDAU , Trokare	329
Klammern	9-53	LANDAU-SEGOND , Hysterektomieklammern	45
Klammern, Arterien-	13-23, 25-28	LANDGRAF , Zahnpinzetten	97
Klammern, Aurikel-	29	LANDOLT , feine Scheren	124
Klammern, Bronchus-	30	LANE , chirurgische Pinzetten	61
Klammern, Bulldog-	10, 11	LANE , Knochenhaltezangen	457
Klammern, Druck-	47, 48	LANE , Magenklammern	531
Klammern, Gallenkanal-	37, 40	LANE , Schraubenzieher	491
Klammern, Hämorrhoiden-	47, 48	LANE , Tuchklammern	51
Klammern, Hysterektomie-	41-45	LANGE , Kleiderscheren	132
Klammern, Kopfhaut-	12, 26	LANGE , Wundklammerpinzetten	225
Klammern, Ligatur- und Präparier-	23-25, 29, 31-36	LANGE-HOHMANN , Knochenhebel	397
Klammern, Nierenstiel-	37-39	LANGENBECK , Amputationsmesser	172
Klammern, Parametrium-	46	LANGENBECK , Elevatorien	447
Klammern, Peritoneum-	49, 50	LANGENBECK , Hartmetallnadelhalter TUC	202
Klammern, Präparier- und Ligatur-	23-25, 29, 31-36	LANGENBECK , Knochenhaltezangen	455
Klammern, Schlauch-	53	LANGENBECK , Nadelhalter	188
Klammern, Tonsillen-	27	LANGENBECK , Raspatorien	443
Klammern, Tuch-	51, 52	LANGENBECK , Resektionssägen	384
KLIMA-ROSSEGGGER , Biopsiekanülen	343	LANGENBECK , Wundhaken	254, 258
Klingenbrecher	177	LANGENBECK-DELICATE , Hartmetallnadelhalter TUC	202
KLINIKUM BERLIN , Schlauchklemme	53	LANGENBECK-KOCHER , Wundhaken	259
KLINKENBERGH-LOTH , Gefäßscheren	117	LANGENBECK-MINI , feine Wundhaken	247
KNAPP , feine Wundhaken	246	LANGENBECK-PARKER , Wundhaken	278
KNIGHTON , selbsthaltende Wundsperrer	297	LANGENBECK-RYDER , Hartmetallnadelhalter TUC	202
Knochenfeilen	450		

	Seite		Seite
Laryngoskope	353-360	MARKHAM-MEYERDING , selbsthaltende Wundsperrerr	294
Laryngoskope, Kaltlicht-	357-360	Markierungspinzetten	98
LAWRENCE , Präparier- und Ligaturklemmen	34	Marknägel	495
LEKSELL-STILLE , Hohlmeisselzangen	473	MARKWALDER , Knochensplitterzangen	477
LEMPERT , Hohlmeisselzangen	470	MARQUARDT , Hohlmeisselzangen	470
LERICHE , Arterienklemmen	16	MARTEL , Kopfhautklemmen	12
LESTER , Fixierpinzetten	84	MARTEL-WILLET , Kopfhautklemmen	12
LEWIN , Knochenhalte-zangen	454	MARTIN , Knorpelfasszangen	453
LEXER , Hartmetallscheren TUC	158	MARTIN , Wundhaken	262
LEXER , Meißel	422, 423	MARTIN-CARTILAGE , Scheren	118
LEXER , Osteotome	422, 423	MARTINI , scharfe Löffel	440
LEXER , Präparierscheren	111	MASS.-GENERAL-HOSPITAL (M.G.H.) , Nadelhalter	183
LEXER-BABY , Präparierscheren	111	MASSE-ROBIN , Bauchdeckenhalter	306
LICHTENBERG , Hartmetallnadelhalter TUC	201	MASSON , Hartmetallnadelhalter TUC	197
LICHTENBERG , Nadelhalter	187	MASSON , Nadelhalter	184
LICHTWITZ , Trokare	330	Mastdarm-Biopsiezangen	551
Ligatur- und Präparierklemmen	23-25, 29, 31-36	Mastdarm-Spekula	534-536
Ligaturscheren	128, 129	MATHIEU , Hartmetallnadelhalter TUC	199
LINCOLN , Gefäßscheren	117	MATHIEU , Mastdarm-Spekula	536
LINDEMANN , Resektionssägen	384	MATHIEU , Nadelhalter	186
Linsenhaltepinzetten	90	MATHIEU , Wundhaken	278
Liposuktions- und Infiltrationskanülen	339, 341, 342	MATHIEU-DELICATE , Hartmetallnadelhalter TUC	199
LISTER , Hartmetallscheren TUC	162	MATHIEU-DELICATE , Nadelhalter	186
LISTER , Tupferzangen	228	MATHIEU-RYDER , Hartmetallnadelhalter TUC	200
LISTER , Verbandscheren	133, 134	MATHIEU-RYDER-VASCULAR , Hartmetallnadelhalter TUC	200
LISTER-EXCENTRIC , Verbandscheren	133	MATSON , Raspatorien	446
LISTON , Amputationsmesser	172	MAYFIELD , Hohlmeißelzangen	470
LISTON , Knochensplitterzangen	477, 480	MAYO ROBSON , Atraumatische Magen- und Darmklemmen	526
LISTON-KEY , Knochensplitterzangen	479	MAYO , Hartmetallscheren TUC	153
LITTAUER , Cilienpinzetten	76	MAYO , Scheren	105
LITTAUER , Ligaturscheren	128	MAYO , Sterilisierklammern	564
LITTAUER , Nagelzangen	569	MAYO-ADAMS , selbsthaltende Wundsperrerr	296
LITTAUER-LISTON , Knochensplitterzangen	477	MAYO-HARRINGTON , Scheren	105
LITTLE , Wundhaken	263	MAYO-HEGAR , Hartmetallnadelhalter TUC	192
LITTLER , feine Scheren	123	MAYO-HEGAR , Nadelhalter	184
LITTLEWOOD , Darmfasszange	518	MAYO-HEGAR-DELICATE , Hartmetallnadelhalter TUC	192
LLOYD-DAVIS , Anastomosenklemmen	529	MAYO-HEGAR-DELICATE , Nadelhalter	184
LOCKHART-MUMMERY , Sonden	311	MAYO-NOBLE , Scheren	105
LOCKLIN , Hartmetallscheren TUC	162	MAYO-ROBSON , Magen- und Darmklemmen	521, 526
LOCKLIN , Zahnfleischscheren	136	MAYO-RUSS. , Fasspinzetten	66
LOCKWOOD , Fasszangen	518	MAYO-STILLE , Hartmetallscheren TUC	154
LOCKWOOD-ALLIS , Fasszange	518	MAYO-STILLE , Scheren	105
LONDON-COLLEGE , Zahnpinzetten	95	MC GIVNEY , Hämorrhoidal-Ligatoren	553
LONG , Hysterektomieklammern	44	MC INDOE , Knochensplitterzangen	478
LORENZ , Verbandscheren	133	MC INDOE , Pinzetten	60
LORNA , Tuchklemme	52	MC INDOE , Scheren	118
LOTH-KLINKENBERGH , Gefäßscheren	117	MC INTOSH FIBRE OPTIC , Laryngoskope	357
LOTH-SCHOEMAKER , Ligaturscheren	128	MC INTOSH , Laryngoskope	353
LOUTE , Drahtspanninstrumente	407	McDONALD , Elevatorien	448
LOVELACE-DIXON , Arterienklemmen	26	McDONALD , Kapsulorhexispinzette	90
LOWER , Gallenkanalklemmen	37	McPHERSON , Nahtpinzetten	85
LUCAE , Hämmer	430	McPHERSON-KELMAN , Nahtpinzetten	85
LUCAE , Nasenpinzetten	77	MEAD , Hämmer	430
LUCAS , Meißel	417	MEAD , Hohlmeißelzangen	469
LUCAS , scharfe Löffel	441	MEEKER , Präparier- und Ligaturklemmen	25
LUER , Hämorrhoidenklemmen, atraumatisch	48	Meißel	417-426
LUER , Hohlmeisselzangen	469	MENGHINI , Biopsiekanülen	344
LUER , Saugrohre	336	Meniskotome	467
LUETHY-BECK , Hartmetallnadelhalter TUC	202	Meniskus- und Knorpelfasszangen	453
Luft Bohraparat	391	Meniskushaken	466
Lungenlappenscheren	118	MERIAM , Zahnpinzetten	96
		Messapparate, Blutdruck-	379
M		Messbecher	556, 559
Magen- und Darmklemmen	520-523	Messer, Abszess-	174
Magen- und Darmquetschklemmen	530	Messer, Amputations-	172
Magenklemmen	531	Messer, Fistel-	174
MAGILL , Katheterzangen	361	Messer, Gips-	318
MAIER-SIMS , Kornzangen	239	Messer, Hirn-	173
		Messer, Organ-	173

	Seite		Seite
Messer, Transplantations-	175	MOORFIELD , Nahtpinzetten	84
Messinstrumente	371-375	MORGAN , Anuskope	541
METZENBAUM , Hartmetallnadelhalter TUC	199	MORGAN , Kaltlicht	541
METZENBAUM , Hartmetallscheren TUC	155, 156	MORRIS , Wundhaken	261
METZENBAUM , Präparierscheren	108	MOSQUITO-HALSTED , Arterienklemmen	15
METZENBAUM-BABY , Präparierscheren	108	MOSQUITO-MICRO , Arterienklemmen	15
METZENBAUM-DELICATE , Hartmetallscheren TUC	158-160	MOYNIHAN , Hysterektomieklappen	44
METZENBAUM-DELICATE , Präparierscheren	110	MUMMERY-LOCKHART , Sonden	311
METZENBAUM-NELSON , Präparierscheren	109	Muskelpinzetten	87, 88
MEYERDING , feine Wundhaken	247	MYRTLE-LEAF , Sonden	310
MEYERDING , selbsthaltende Wundsperrerr	294		
MEYERDING , Wundhaken	273	N	
MEYERDING-MARKHAM , selbsthaltende Wundsperrerr	294	NABATOFF , Krampfaderbesteck	312
MICHEL , Wundklammern	225	Nabelschnurscheren	121
MICHEL , Wundklammerpinzetten	224	Nachstarscheren	139
MICHEL , Wundklammerzängchen	224	Nadelhalter	180-213
MICRO-ADSON , Pinzetten	59	Nadelhalter, Boomerang-	189
MICRO-FRIEDMAN , Hohlmeißelzange	476	Nadelhalter, Hartmetall TUC-	192-205
MICRO-MOSQUITO , Arterienklemmen	15	Nadelhalter, Mikro-	204-213
MICRO-RYDER , Hartmetallnadelhalter TUC	193	Nadeln, Führungs-	346
MICROVASCULAR , Hartmetallnadelhalter TUC	193	Nadeln, REVERDIN	214
MICRO-WULLSTEIN , Saugrohre	335	Nadeln, Unterbindungs-	215-219
MIDDELDORPF , Wundhaken	264	Nadel-Sterilisierkästen	560
Mikronadelhalter	204-213	Nägel	492-498
Mikronadelhalter mit Rundgriff	206-209	Nagelfeilen	579
Mikropinzetten	71, 72	Nagelscheren	135
Mikroscheren	143-149	Nagelspaltscheren	135
Mikroscheren, Adventitia	145, 147	Nagelzangen	568-570
Mikroscheren, Dissection	145, 147	NAGER , Unterbindungsnadeln	219
Mikroscheren, Nerve	147	Naht	180-225
MIKULICZ , Peritoneumklemmen	49	Nahtpinzetten	85, 86
MIKULICZ , Wundhaken	268	Nahtpinzetten	97
MIKULICZ-BABY , Peritoneumklemmen	49	Narkose	353-363
MILLER FIBRE OPTIC , Laryngoskope	359	Nasen- und Ohrpinzetten	77, 78
MILLER , Artikulationspapierpinzette	98	Nasenscheren	119, 120
MILLER , Laryngoskope	355	NEFF , Meniskotome	467
MILLER-SENN , feine Wundhaken	250	NEGUS , Gallenkanalklemmen	40
MILLIGAN , selbsthaltende Wundsperrerr	288	NEIVERT , Hartmetallnadelhalter TUC	195
MILLS , Gefäßschere	116	NEIVERT , Nadelhalter	181
MINI , Skalpellgriffe	167	NELATON , Sonden	310
MINI , Skalpellklingen	167	NELSON , Fasspinzetten	66
MINI-FRIEDMAN , Hohlmeißelzangen	468	NELSON , Trokare	328
MINI-HOHMANN , Knochenhebel	395	NELSON-METZENBAUM , Präparierscheren	109
MINI-LAMBOTTE , Osteotome	426	NERVE , Mikroscheren	147
MINI-LANGENBECK , feine Wundhaken	247	Nerv-Präparierscheren	111
MINI-LEXER , Meißel	422	NEUMANN , Zahnfleischscheren	137
MINI-LEXER , Osteotome	422	Neurochirurgiescheren	115-117
MISKIMON , selbsthaltende Wundsperrerr	289	NEW ORLEANS , Hartmetallnadelhalter TUC	194
MIXTER , Chirurgische Scheren	104	NEW ORLEANS , Nadelhalter	183
MIXTER , Präparier- und Ligaturklemmen	33, 34	Nierenschalen	559
MIXTER-BABY , Präparier- und Ligaturklemmen	33	Nierenstielklemmen	37-39
MIXTER-O'SHAUGNESSY , Präparier- und Ligaturklemmen	33	NIRO , Drahtzangen	401
MIXTER-OVERHOLT , Präparier- und Ligaturklemmen	29	NOBLE-MAYO , Scheren	105
MOD. BONN , feine Scheren	124	nopa PROFI , Autopsie-Säge	484
MOD. BONN , Irispinzetten	81	NORTHBENT , Ligaturscheren	129
MOD. BONN , Nahtpinzetten	86	NOTO , Schwammzangen	234
MOD. TÜBINGEN , Nahtpinzetten	86	NOYES , Iridektomiescheren	138
MOD. TÜBINGEN-VANNAS , Nachstarscheren	139	NUSSBAUM , Magen- und Darmklemmen	523
MOD. USA , Gipspreizer	319		
MOD. USA , Nabelschnurscheren	121	O	
MOD. USA/SMITH , Verbandscheren	133	O'BRIAN , feine Scheren	124
MOD. WIEN , Nahtinstrumente	223	OBWEGESER , Ramushaken	257
MODELL TÜBINGEN , Wundhaken	262	OBWEGESER , Weichteilhaken	255, 256
MODELL USA , Pinzetten	59	OCHSNER , Trokare	329
MOELTGEN , Goniometer	373	OCHSNER-KOCHER , Arterienklemmen	20, 21
MOLDESTAD , feine Wundhaken	244	O'CONNOR , feine Wundhaken	243
MOLLISON , selbsthaltende Wundsperrerr	289	O'CONNOR-O'SULLIVAN , Bauchdeckenhalter	301
MOLT , Raspatorien	444		
MOORE , Handbohrapparate	387		

	Seite		Seite
OEHLER , Hartmetallpinzetten TUC	92	Pinzetten, Mikro-	71, 72
Ohr- und Nasenpinzetten	77, 78	Pinzetten, Muskel-	87
OLIVECRONA , Gefäßscheren	117	Pinzetten, Naht-	85, 86
OLLIER , Wundhaken	253	Pinzetten, Ohr- und Nasen	77, 78
OLSEN-HEGAR , Hartmetallnadelhalter TUC	198	Pinzetten, Splitter-	73-75
OLSEN-HEGAR , Nadelhalter	185	Pinzetten, Tampon-	78
OLSEN-HEGAR-USA , Hartmetallnadelhalter TUC	198	Pinzetten, Uhrmacher-	69
OMBREDANNE , Hämmer	427	Pinzetten, Wundklammer-	224, 225
Operations-Skalpelle	169-171	Pinzetten, Zahn-	95-97
Optischer Retraktor	281, 282	PLESTER , Saugrohre	335
Organmesser	173	PLESTER , selbsthaltende Wundsperrerr	295
OSCINOPA , Autopsie-Säge	483	POOLE , Saugrohre	332
OSCINOPA , elektrische Gipsäge	321	POOLE-BABY , Saugrohre	332
Osteotome	417-426	POTTS-DE MARTEL , Gefäßscheren	116
O'SULLIVAN-O'CONNOR , Bauchdeckenhalter	301	POTTS-SMITH , Gefäßscheren	113, 115
OTOSKOP UNI , Diagnostikbesteck	381	POTTS-SMITH , Hartmetallmikronadelhalter TUC	205
OVERHOLT , Präparier- und Ligaturklemmen	24	POTTS-SMITH , Hartmetallpinzetten TUC	92
OVERHOLT-BABY , Präparier- und Ligaturklemme	23	POTTS-SMITH , Hartmetallschere TUC	157
OVERHOLT-GEISSENDOERFER , Präparier- und Ligaturklemmen	23	POTTS-SMITH , Mikronadelhalter	212
OVERHOLT-MIXTER , Präparier- und Ligaturklemmen	29	POTTS-SMITH , Pinzetten	63
		POTTS-SMITH , Scheren	118
P		Präparier- und Ligaturklemmen	23-25, 29, 31-36
PALMER , Nägel	496	Präparierschere	108-112
PARAMETRIUM , Hartmetallschere TUC	154	PRATT , Fistelsonden	311
PARAMETRIUM , Parametriumklemmen	46	PRATT , Hämorrhoidenklemmen	47
Parametriumklemmen	46	PRATT , Mastdarm-Spekula	536
PARKER , Wundhaken	278	PRECISA , Blutdruckmessapparate	379
PARKER-LANGENBECK , Wundhaken	278	PRESBYTERIAN , Schlauchklemmen	53
PARTSCH , Hämmer	430	PRINCE , Muskelpinzetten	87
PARTSCH , Meißel	418	PRINCE , Tonsillenschere	119
PATON , Mikronadelhalter	212	Proktoskope	537-543
PAUFIQUE , Nahtpinzetten	86	PROVIDENCE-HOSPITAL , Arterienklemmen	16
PAYR , Darm- und Magenquetschklemmen	530	Punktion/Kanülen	327-349
PAYR , Führungshohlsonden	221	PUTTI , Raspeln	451
PAYR-BABY , Darm- und Magenquetschklemmen	530	PYE-SMITH (HARRISON) , Sterilisierzangen	564
PAYR-SCHMIEDEN , Führungshohlsonden	221	PYNCHON-ANDREWS , Saugrohre	331
PEAN , Fasszangen	13		
PEAN-DELICATE , Arterienklemmen	22	Q	
PEAN-ROCHESTER , Arterienklemmen	18, 19	QUINBY , Zahnfleissschere	137
PEERS , Tuchklemmen	52	QUINKE , Biopsiekanülen	344
PEET , Splitterpinzetten	75		
PELKMANN , Tupferzangen	235	R	
PENNINGTON , Fasszangen	13	RABINER , Perkussionshammer	369
PERCY , Amputationsschild	463	RADOLF , Nagelzangen	482
Peritoneumklemmen	49, 50	RAGNELL-DAVIS , feine Wundhaken	250
Perkussionshämmer	369, 370	RAGNELL-KILNER , Präparierschere	112
PERRY , Zahnpinzetten	97	RALK , Handbohrapparate	389
PERTHES , Handbohrapparate	390	RALK , Splitterpinzetten	75
PHANEUF , Hysterektomieklammern	45	RAMPLEY , Schwammzangen	238
PHILIPS , Schraubenzieher	491	Ramushaken	257
PIERCE , Trokare	330	RANKIN-CRILE , Arterienklemmen	17
PIFFARD , scharfe Löffel	436	RANKIN-KELLY , Arterienklemmen	17
PINARD , Stethoskope	377	Rasierklingen	177
Pinzetten	57-98	Raspatorien	442-446
Pinzetten, anatomisch	57-65	Raspeln	451
Pinzetten, Artikulationspapier-	98	REHN , Transplantationsmesser	175
Pinzetten, Chalazion-	88, 89	REILL , Mikronadelhalter	207
Pinzetten, chirurgisch	57-65, 67, 68	REINER , Gipsmesser	318
Pinzetten, Cilien-	76	Reinigungsbürsten	583-589
Pinzetten, Deckglas-	78	Reinigungspistole	590, 591
Pinzetten, Entropium-	88	Rektoskope	544-550
Pinzetten, Fass-	66-68, 70, 316	Repositionszangen	487
Pinzetten, Fixier-	84	RESANO , Atraumatische Magen- und Darmklemmen	527
Pinzetten, Hartmetall TUC	92-94	Resektions- und Amputationssäge	384
Pinzetten, Iris-	79-82	REVERDIN , Bauchspatel	308
Pinzetten, Kapsel-	83	REVERDIN -Nadeln	214
Pinzetten, Knüpf- mit Plateau	71, 72	REYNOLDS , Präparierschere	112
Pinzetten, Markierungs-	98		

	Seite		Seite
REZAK-HEANEY , Hysterektomieklappen	44	Scheren, Chirurgische-	102-105, 122
RIBBON , Augenscheren	127	Scheren, Darm-	118
RICARD , Bauchdeckenhalter	306	Scheren, Draht-	130
RICHARDSON-EASTMAN , Wundhaken	264	Scheren, Episiotomie-	121
RICHARDSON-KELLY , Wundhaken	264	Scheren, fein	122-124
RICHTER , Chirurgische Scheren	104	Scheren, Gefäßchirurgie-	113-117
RICHTER-HEATH , Wundklammerzängchen	224	Scheren, Gips-	134
RIGHBY , selbsthaltende Wundsperrerr	295	Scheren, Gynäkologisch	105-107
RIRAP , Stethoskop	378	Scheren, Hartmetall TUC	152-162
RISCOPE S , Ophthalmoskop	381	Scheren, Haut-	135
RISCOPE S , Oto-/Ophthalmoskop	380	Scheren, Hornhaut-	141-143
ROBERTS , Arterienklappen	30	Scheren, Iridektomie-	138
ROBIN-MASSE , Bauchdeckenhalter	306	Scheren, Kapsulotomie	140
ROCHESTER-CARMALT , Arterienklappen	27	Scheren, Kleider-	132, 133
ROCHESTER-PEAN , Arterienklappen	18, 19	Scheren, Knorpel-	118
ROEDER , Tuchklappen	52	Scheren, Kronen-	130, 131
ROETTGEN-RUSKIN , Hohlmeißelzangen	473	Scheren, Kropf-	119
ROGGE , Sterilisierzangen	564	Scheren, Ligatur-	128, 129
ROLLET , feine Wundhaken	246	Scheren, Lungenlappen-	118
ROSCHKE , Anoskop	537	Scheren, Mikro-	143-149
ROSSEGGER-KLIMA , Biopsiekanülen	343	Scheren, Nabelschnur	121
ROTTER , Unterbindungsnadeln	219	Scheren, Nachstar-	139
ROUX , Wundhaken	277	Scheren, Nagel-	135
ROWE , Repositionszange	487	Scheren, Nagelspalt-	135
RUDD , Hämorrhoidal-Ligatoren	554	Scheren, Nasen-	119, 120
RUMEL , Präparier- und Ligaturklappen	31	Scheren, Neurochirurgie-	115-117
Runde Schalen	559	Scheren, Präparier-	108-112
RUSKIN , Hohlmeißelzangen	471, 475	Scheren, Sehnen-	126, 140
RUSKIN-LISTON , Knochensplitterzangen	478	Scheren, Strabismus-	126
RUSKIN-MINI , Hohlmeißelzangen	471	Scheren, Supercut SC	101
RUSS. MODELL , Fasspinzetten	68	Scheren, Tonsillen-	119
RUSS.-MAYO , Fasspinzetten	66	Scheren, Verband-	132-134
RYDER-FRENCH-EYE , Hartmetallnadelhalter TUC	193	Scheren, Zahnfleisch-	136, 137
RYDER-LANGENBECK , Hartmetallnadelhalter TUC	202	Schieblehre	372, 373
RYDER-MATHIEU VASCULAR , Hartmetallnadelhalter TUC	200	SCHINDLER , Peritoneumklemme	50
RYDER-MATHIEU , Hartmetallnadelhalter TUC	200	SCHINK , Dermatome	176
RYDER-MICRO , Hartmetallnadelhalter TUC	193	Schlauchklappen	53
S		SCHMID , Spezialkanülen	345
Säge, Gips-	318	SCHMIEDEN , Unterbindungsnadeln	217
Sägeblätter für elektrische Gips Sägen	323	SCHMIEDEN-PAYR , Führungshohlsonden	221
Sägen	384, 482-485	SCHMIEDEN-TAYLOR , Gefäßscheren	116
SALAH , Biopsiekanülen	343	SCHNIDT-SAWTELL , Tonsillenklemmen	27
SALENIUS , Meniskotome	467	SCHOEMAKER , Kropfschere	119
SAMII , Pinzetten	70	SCHOEMAKER-LOTH , Ligaturschere	128
SANVENERO , Präparierschere	112	Schraubenzieher	491
SAROT , Bronchusklemmen	30	SCHUHKNECHT , selbsthaltende Wundsperrerr	289
SAROT , Hartmetallnadelhalter TUC	197	SCHUKNECHT , Drahtschere	130
SAROT , Nadelhalter	183	SCHULZE-BERGMANN , Mastdarm-Spekula	535
SATINSKY , Gefäßschere	117	SCHUMACHER , Nabelschnurschere	121
SATTERLEE , Amputationssägen	384	Schutzzange	390
SATTLER , Muskelpinzetten	87	Schwammzangen	228-239
SAUERBRUCH , Hohlmeißelzangen	474	SCHWECKENDICK-GOOD , Tonsillenschere	119
SAUERBRUCH , Wundhaken	260, 274	SCUDDER , Atraumatische Magen- und Darmklappen	526
Saugrohre	503	SCUDDER , Magen- und Darmklappen	523, 526
Saugrohre	331-337	SEBILEAU , Elevatorien	447
SAWTELL-SCHNIDT , Tonsillenklemmen	27	SEDILLOT , Raspatorien	445
SAWYER , Mastdarm-Spekula	534	SEGOND , Hysterektomieklappen	45
SCALP-CONTOUR , selbsthaltende Wundsperrerr	294	SEGOND-LANDAU , Hysterektomieklappen	45
SCHAEDEL , Tuchklappen	51	Sehnenfassinstrumente	464
Schalen	559, 561, 562	Sehnenklappen	126, 140
SCHANZ , Bohrdrähte	503	Sehnenstripper	465
Scharfe Löffel	434-441	Selbsthaltende Wundsperrerr	283, 284, 287-297
SCHEDE , scharfe Löffel	435	SELLORS-CRAFOORD , Aurikelklappen	29
Scheren	102-162	SEMB , Hohlmeißelzangen	472
Scheren, Anatomie-	118	SEMB , Knochenhalte zangen	456
Scheren, Augen-	125-127, 138-143	SEMB , Knochensplitterzangen	480
Scheren, Bauchdecken-	106	SEMB , Raspatorien	446
		SEMKEN , Hartmetallpinzetten TUC	92
		SEMKEN , Pinzetten	60, 61

	Seite		Seite
SEMM , Bauchdeckenhalter	303	STELLBRINK , Hohlmeisselzangen	468
SENN-GREEN , feine Wundhaken	247	Sterilisierklammern	564
SENNING (SCHWED. MODELL) , Hartmetallnadelhalter TUC	194	Sterilisierzangen	564
SENNING (SCHWED. MODELL) , Nadelhalter	183	STERNUM , Drahtzangen TUC	403
SENN-MILLER , feine Wundhaken	250	STERNUM , Hartmetalldrahtzangen TUC	203
SENN-MILLER-BABY , feine Wundhaken	250	Stethoskope	377, 378
Sensibilitätsinstrumente	376	STEVENS , Hartmetallschere TUC	161
SEUTIN , Verbandscheren	134	STEVENS , Irispinzetten	80
SHORTBENT , Ligaturscheren	129	STEVENS , Mikronadelhalter	212
SIEBOLD , Gynäkologische Scheren	107	STEVENS , Sehnenscheren	126
SIMON , Fistelmesser	174	STIEGLITZ , Splitterpinzetten	75
SIMON , Wundhaken	262	STILLE , Gipsschere	320
SIMS , Gynäkologische Scheren	107	STILLE , Handbohrapparate	386
SIMS , Hartmetallscheren TUC	155	STILLE , Hohlmeißelzangen	472
SIMS , Mastdarm-Spekula	534	STILLE , Meißel	421
SIMS-MAIER , Kornzangen	239	STILLE , Nierenstielklemmen	38
SINGLEY-TUTTLE , Fasspinzetten	66	STILLE , Osteotome	421
SINUSCOPY , Trokare	327	STILLE , Pinzetten	65
Skalpelle	165-177	STILLE-BARRAYA , Pinzetten	65
Skalpellgriffe	165-167	STILLE-DOYEN , Wundhaken	266
Skalpellslingen	167, 168	STILLE-LISTON , Knochensplitterzangen	479
SMILLIE , Meniskotome	467	STILLE-LUER , Hohlmeißelzangen	473
SMILLIE , Meniskushaken	466	STILLE-MAYO , Hartmetallscheren TUC	154
SMITH , Drahtscheren	130	STILLE-MAYO , Scheren	105
SMITH-BUIE , Mastdarm-Spekula	536	STILLE-RUSKIN , Hohlmeißelzangen	472
SMITH-FERRIS , Pinzetten	65	STILLE-SHERMAN , Handbohrapparate	385
SMITH-HEYWOOD , Schwammzangen	236	Stirnlampen	368
SMITH-MODELL USA , Verbandscheren	133	Stirnspiegel	367
SMITH-PETERSEN , Meißel	419	Stössel	451
SMITH-PETERSEN , Osteotome	419	Strabismusscheren	126
SMITH-PETERSON , Hohlmeisselzangen	475	STRATTE , Hartmetallnadelhalter TUC	197
SMITH-POTTS , Gefäßscheren	113, 115	STRATTE , Nadelhalter	185
SMITH-POTTS , Hartmetallmikronadelhalter TUC	205	STRAUSS , Rektoskope	548
SMITH-POTTS , Hartmetallpinzetten TUC	92	STRULLY , Gefäßscheren	115
SMITH-POTTS , Mikronadelhalter	212	SULLIVAN , Zahnfleissscheren	137
SMITH-POTTS , Pinzetten	63	SULLIVAN-BROPHY , feine Scheren	123
SMITH-POTTS , Scheren	118	Super Cut Scheren	101
SNELLEN , Entropiumpinzette	88	SYME , Unterbindungsnadeln	216
SNITMAN , selbsthaltende Wundsperrer	284		
Sonden	310, 311	T	
Sonden, Führungshohl-	220-222	Tablett	561
Spatel, Bauch-	308	Tamponpinzetten	78
SPENCER , Ligaturscheren	128	TAYLOR , Knochenheber	398
SPENCER-DELICATE , Ligaturscheren	128	TAYLOR , Perkussionshammer	369
SPENCER-WELLS , Arterienklemmen	14	TAYLOR , Pinzetten	61
Sphinkteroskope, Anuskope, Proktoskope	537-541	TAYLOR , Spinalhaken	250
Spiegel, Stirn-	367	TAYLOR-CUSHING , Hartmetallpinzetten TUC	93
Spinalhaken	250	TAYLOR-SCHMIEDEN , Gefäßscheren	116
Spirituslampen	556	TERRIER , Arterienklemme	14
Splitterpinzetten	73-75	TERSON , Irispinzetten	83
SPRATT , scharfe Löffel	435	THIERSCH , Transplantationsmesser	175
Spreizer, Gips-	319	THIESS , Hämmer	430
Spritzen	348	THOMS-ALLIS , Fasszangen	518
Spülschalen	562	THOREK , Präparierscheren	111
ST. MARKS , Wundhaken	275	THORPE , Schieblehre	372
ST. MARTIN , Nahtpinzetten	85	TOENNIS , Gefäßscheren	116
STACKE , Sonden	310	TOENNIS , Hartmetallnadelhalter TUC	201
STADLER-BRAUN , Episiotomiescheren	121	TOENNIS , Nadelhalter	188
STANDARD , anatomische Pinzetten	57	TOENNIS , Präparier- und Ligaturklemmen	36
STANDARD , chirurgische Pinzetten	57	TOENNIS-ADSON , Gefäßscheren	116
STANDARD , Chirurgische Scheren	102	TOENNIS-ADSON-DELICATE , Hartmetallscheren TUC	161
STANDARD , Hartmetallscheren TUC	152, 153	TOHOKU-JAPAN , Tuckklemmen	52
STANDARD , Trokare	327	Tonsillenklemmen	27
STANDARD , Zahnfleissscheren	137	Tonsillenscheren	119
Standgefäße	562	TOWNLEY , Schieblehre	372
Stechbecken	563	Transplantationsmesser	175
STEINBACH , Hämmer	432	TRAVERS , selbsthaltende Wundsperrer	288
STEINMANN , Knochennägel	399, 497, 498	TRELAT , Unterbindungsnadeln	218
STEINMANN , Sehnenfassinstrumente	464		

	Seite		Seite
Trephine, Gips-	318	WALTON , Kornzangen	239
TROCAR , Biopsiekanülen	344	WALTON , selbsthaltende Wundsperrerr	297
TROELTSCH-WILDE , Ohrpinzetten	77	WALTON-LISTON , Knochensplitterzangen	478
TROEMNER , Perkussionshammer	370	WALTON-YANKAUER , Saugrohre	331
Trokare	327-330	WANGENSTEEN , Hartmetallnadelhalter TUC	197
TROUTMAN (CORNEAL) , Irispinzetten	82	WANGENSTEEN , Hartmetallpinzetten TUC	94
TROUTMAN , Hornhautscheren	141	WANGENSTEEN , Nadelhalter	185
TROUTMAN , Mikronadelhalter	207	WANGENSTEEN , Pinzetten	65
TROUTMAN-BARRAQUER , Mikronadelhalter	206	WANGENSTEEN-DELICATE , Nadelhalter	185
TROUTMAN-CHRIS , Klängenbrecher	177	WARTENBERG , Sensibilitätsinstrumente	376
TÜBINGEN MOD. , Nahtpinzetten	86	WATSON , Dermatome	176
TÜBINGEN MODELL , Wundhaken	262	Watteträger	311, 312
TÜBINGER MODELL , selbsthaltende Wundsperrerr	296	WAUGH , Fassspinzette	67
Tuchklemmen	51, 52	WEBSTER , Hartmetallnadelhalter TUC	195
TUDOR-EDWARDS , Knochensplitterzangen	479	WEBSTER , Nadelhalter	181
TUFFIER , Bauchspatel	308	WECKER , Iridektomiescheren	138
TUFFIER , Fasszangen	12	Weichteilhaken	255, 256
TUFFIER , Wundhaken	267	WEITLANER , selbsthaltende Wundsperrerr	287
TUOHY , Biopsiekanülen	344	WEITLANER-BABY , selbsthaltende Wundsperrerr	287
Tupferzangen	229-239	WELLS-SPENCER , Arterienklemmen	14
TURNBULL , Nagelzangen	568	WERTHEIM , Hartmetallnadelhalter TUC	198
TUTTLE-SINGLEY , Fasspinzetten	66	WERTHEIM , Hysterektomieklammen	41, 42
		WERTHEIM , Nadelhalter	185
U		WERTHEIM , Scheren	106
UCKERMANN , Watteträger	312	WERTHEIM-CULLEN , Hysterektomieklammen	44
Uhrmacherpinzetten	69	WESTCOTT , Mikroscheren	143
ULRICH , Knochenhalte-zangen	462	WESTCOTT , Sehnenscheren	140
ULRICH , Kornzangen	229	WESTERMARK , Tupferzangen	232
UNIVERSAL , Drahtscheren	130	WIGMORE , Gipsmesser	318
UNIVERSAL , Handbohrapparate	389	WIKSTROEM , Präparier- und Ligaturklemmen	41
UNIVERSAL , Hartmetallscheren TUC	162	WILDBERG , Klammern	496
UNIVERSAL , Hohlmeißelzangen	468	WILDE-TROELTSCH , Ohrpinzetten	77
UNIVERSAL , Trokare	327	WILLET-MARTEL , Kopfhautklemmen	12
UNIVERSAL , Verbandschere	132	WILLIAMS , Fasszangen	518
Universalretraktor	282	WILLIGER , Elevatorien	447
Unterbindungs-nadeln	215-219	WILLIGER , Hämmer	428
Urinale	563	WILLIGER , Raspatorien	444
V		WILLIGER , scharfe Löffel	440
VACUNOPA , Vakuumsauger	324	WILMER , Augenscheren	126
VAN BUREN , Knochenhalte-zangen	452	WOLFF , Gipsabreisszange	320
VANNAS MOD. TÜBINGEN , Nachstarscheren	139	WULLSTEIN MICRO , Saugrohre	335
VANNAS , Nachstarscheren	139	WULLSTEIN , selbsthaltende Wundsperrerr	289
Verband	318-324	Wund- und Meniskushaken	466
Verbandscheren	132-134	Wundhaken	242-308
Verbindungsstücke	349	Wundhaken mit Kaltlichtbeleuchtung	281
VERBRUGGE , Knochenhalte-zangen	459	Wundhaken, fein	242-250
VERNET-GIL , feine Wundhaken	249	Wundklammern	225
VERNIER , Schieblehre	372, 373	Wundklammerpinzetten	224, 225
VERRES , Spezialkanülen	345	Wundklammerzängchen	224
VIRCHOW , Hirnmesser	173	Wundsperrerr, selbsthaltend	283, 284, 287-297
WISE , Knüpfpinzetten mit Plateau	71	Wundspreizer für die Handchirurgie	285
VOLKMANN , scharfe Löffel	434, 440	Y	
VOLKMANN , Wundhaken	251, 252	YANCOSKIE , Abdominoplastikretraktor	280
Vorbohrer für Knochenschrauben	513	YANKAUER , Saugrohre	331
Vorderkammerpinzetten	85	YANKAUER-WALTON , Saugrohre	331
W		YEOMAN , Mastdarm-Biopsiezangen	551
WACHENFELDT , Wundklammerpinzetten	224	YOUNG-HRYNTSCHAK , Nadelhalter	189
WAGNER , feine Scheren	122	Z	
WALB , Organmesser	173	Zahnfleischscheren	136, 137
WALDMANN , Episiotomiescheren	121	Zahnpinzetten	95-97
WALTER , Wundhaken	250	Zängchen, Wundklammer-	224
WALTER-CARMALT , Splitterpinzetten	73	Zangen, Draht- mit Hartmetalleinsätzen TUC	203
WALTON , feine Scheren	124	Zangen, Gipsabreiss-	320
WALTON , Fingerringsägen	482	Zangen, Korn-	229-239
		Zangen, Schwamm-	228-239

	Seite	Seite
Zangen, Tupfer-	229-239	
ZAUFAL-JANSEN , Hohlmeißelzangen	471	
ZENKER , Präparier- und Ligaturklemmen	32	
ZENKER , Wundhaken	272	
ZIEGLER , Cilienpinzetten	76	
Zubehör für Bohrapparate	392	
Zubehör für Haken-Marknägel	490	
ZWEIFEL , Hartmetallnadelhalter TUC	202	
ZWEIFEL , Nadelhalter	187	

Index

	Page		Page
A		AYER , chalazion forceps	
Abdominal, retractors	298-307		88
Abdominal, scissors	106	B	
Abdominal, spatulas	308	BABCOCK , intestinal tissue forceps	519
Abscess knives	174	BABCOCK , tissue seizing forceps	9
Accessories for drills	392	BABINSKY , percussion hammers	369
Accessories for intramedullary pins with hook	490	BABY KOCHER , Non-traumatic stomach and intestinal forceps	526
Accu power drill	391	BABY-ADSON , ligature and dissecting forceps	25
ADAMS-MAYO , selfretaining retractors	296	BABY-ADSON , selfretaining retractors	292
ADISON , protecting forceps	390	BABY-BALFOUR , abdominal retractors	299
ADLERKREUTZ , tissue forceps	65	BABY-COLLIN , abdominal retractors	304
ADSON , dissecting and ligature forceps	25	BABY-CRILE-WOOD , needle holders	182
ADSON , dissecting forceps tungsten TUC	93	BABY-CRILE-WOOD , needle holders tungsten TUC	196
ADSON , dressing forceps	59, 60	BABY-DOYEN , stomach and intestinal clamp forceps	520
ADSON , elevators	449	BABY-KOCHER , stomach and intestinal clamp forceps	521, 526
ADSON , needle holders	183	BABY-LEXER , scissors	111
ADSON , selfretaining retractors	290, 291	BABY-LIGHTWEIGHT-DUPLEX , stethoscopes	378
ADSON , suction tubes	335	BABY-METZENBAUM , scissors	108
ADSON-ANDERSON , selfretaining retractors	290	BABY-MIKULICZ , peritoneal clamp forceps	49
ADSON-BABY , dissecting and ligature forceps	25	BABY-MIXTER , dissecting and ligature forceps	33
ADSON-BABY , selfretaining retractors	292	BABY-OVERHOLT , dissecting and ligature forceps	23
ADSON-BECKMANN , selfretaining retractors	293	BABY-POOLE , suction tubes	332
ADSON-BROWN , tissue forceps	60	BABY-SENN-MILLER , delicate retractors	250
ADSON-MICRO , dressing and tissue forceps	59	BABY-WEITLANER , selfretaining retractors	287
ADSON-TOENNIS , scissors	116	BACKHAUS , towel forceps	52
ADSON-TOENNIS-DELICATE , scissors tungsten TUC	161	BACON , bone rongeurs	470
Adventitia , micro scissors	145, 147	BAINBRIDGE , artery forceps	27
Air power drill	391	BAINBRIDGE , Non-traumatic stomach and intestinal clamp forceps	524
ALAN PARKS , anoscopes	537	BALFOUR US-TYPE , abdominal retractors	299
Alcohol burners	556	BALFOUR , abdominal retractors	299, 300
ALDERDYCE , elevators	448	BALFOUR-BABY , abdominal retractors	299
ALEXANDER , chisels	418	BALL & SOCKET , towel forceps	52
ALEXANDER , raspatories	446	BALLANTINE-HEANEY , hysterectomy forceps	43
ALLIS , tissue seizing forceps	9	BALLENGER-FOERSTER , sponge holding forceps	237
ALLIS , tissue seizing forceps	517	Bandage scissors	132-134
ALLIS-ADAIR , tissue seizing forceps	517	BARRAQUER , anterior chamber forceps	85
ALLIS-BABY , tissue seizing forceps	517	BARRAQUER , cilia forceps	76
ALM , selfretaining retractors	283	BARRAQUER , iris scissors	138
ALY , sensibility instruments	376	BARRAQUER , needle holders	206
Amputating and resection saws	384	BARRAQUER-KATZIN (COLIBRI) , iris forceps	82
Amputating knives	172	BARRAQUER-KATZIN , corneal scissors	142
Amputation shield	463	BARRAQUER-TROUTMAN , micro needle holders	206
Anaesthesia	353-363	BARRAYA-STILLE , tissue forceps	65
Anastomosis clamps forceps	528, 529, 532, 533	Battery / Charger	393
ANDERSON-ADSON , selfretaining retractors	290	BAUMGARTNER , needle holders	184
ANDREWS-PYNCHON , suction tubes	331	BECK-LUETHY , needle holders tungsten TUC	202
Angiotribe	47, 48	BECKMANN , selfretaining retractors	292
Anoscopes	537-543	BECKMANN-ADSON , selfretaining retractors	293
Anterior chamber forceps	85	BECKMANN-EATON , selfretaining retractors	293
ANVIL , nail splitting forceps	571	Bed pans	563
ARLT-FISCHER , iris forceps	80	BEEBEE , crown scissors	130, 131
ARRUGA , capsular forceps	83	BEER , cilia forceps	76
ARRUGA , micro needle holder	212	BEESON , plaster cast spreader	319
ARRUGA , needle holder	180	BENGOLEA , artery forceps	28
ARRUGA , needle holder tungsten TUC	201	BENSAUDE , anoscopes	540
ARRUGA-KALT , micro needle holder	212	BERENS , muscular forceps	88
Artery forceps	13-23, 25-28	BERGMANN , bandage scissors	132
Artery forceps, delicate	22	BERGMANN , mallets	427
Arthroscopy	408-415	BERGMANN , plaster saw	318
Articulating paper forceps	98	BERKE , chalazion forceps	89
Auricle forceps	29	BERLINER , percussion hammers	370
AUSTIN , tying forceps	71	BERNHARD , towel forceps	51
AUSTRALIA , finger retractor	283	BEYER , bone rongeurs	471
AUSTRALIA , hand surgery retractors	285	BILLROTH , retractors	252

	Page		Page
BINKHORST , capsular forceps	83	C	
Biopsy needles	343, 344	CAIRNS , artery forceps	22
BIRCHER , meniscotomy knives	467	Caliper	372, 373
BIRCHER-GANSKE , bone holding forceps	453	CAMBELL , trocars	328
BIRKETT , dissecting and ligature forceps	41	CANNY RYALL , retractors	279
BISHOP-HARMAN , iris forceps	82	CAPLAN , nasal scissors	119
Blade breakers	177	Capsular forceps	83
BLASCOVICS , muscular forceps	87	Capsulorhexis forceps	90
BLOND , anoscopes	542, 543	Capsulotomy scissors	140
Blood pressure manometers	379	CARDINALE , scissors	107
Blood vessel clamps	12	CARDINALE , scissors tungsten TUC	155
BLOUNT , bone levers	398	CARDIOPHON , stethoscope	378
BLOUNT , knee retractors	466	CARMALT-ROCHESTER , artery forceps	27
BLUEPOWER , electric plaster saw	322	CARMALT-WALTER , splinter forceps	73
BLUMENTHAL , bone rongeurs	469	CAROLL , goniometers	373
BÖHLER , bone rongeurs	471	CAROLL , tendon seizing instruments	464
BÖHLER , extension bows	399	CARREL , artery forceps	14
BOLEY , caliper	373	CARROLL , needle holders	182
BONACCOLTO , suture forceps	85	CARROLL , needle holders tungsten TUC	194
Bone curettes	434-441	Cartilage scissors	118
Bone Cutting Forceps	477-480	CARTILAGE-MARTIN , scissors	118
Bone files	450	Cartridge syringes	347
Bone holding clamps	394	CASTROVIEJO , blade breakers	177
Bone holding forceps	452, 454-462	CASTROVIEJO , capsular forceps	83
Bone levers	395-398	CASTROVIEJO , circle	375
Bone Rongeurs	468-476	CASTROVIEJO , circle	375
Bone Screws	505-512	CASTROVIEJO , corneal section scissors	141
BONNEY , dissecting forceps tungsten TUC	94	CASTROVIEJO , fixation forceps	84
BONNEY , grasping forceps	68	CASTROVIEJO , iris scissors	138
Boomerang needle holders	189	CASTROVIEJO , micro needle holders	210, 213
BÖTTCHER , tonsil scissors	119	CASTROVIEJO , micro needle holders tungsten TUC	204, 205
Bowls	559, 561, 562	CASTROVIEJO , suture forceps	85
BOYNTON , needle holders	180	CASTROVIEJO-EPKER , circle	375
BOYNTON , needle holders tungsten TUC	201	CASTROVIEJO-KALT , micro needle holders	212
BOYS-ALLIS , tissue seizing forceps	518	Catheter forceps	360
BOZEMANN , dressing forceps	233	CATLIN , amputating knives	172
BOZEMANN , ligature instruments	223	CHADWICK , eye scissors	126
BOZEMANN , needle holders	182	Chalazion forceps	88, 89
BOZEMANN , needle holders tungsten TUC	197	CHAPUT , seizing forceps	12
BOZEMANN-DOUGLAS , dressing forceps	233	Charger / Battery	394
Brain knives	173	CHARRIERE , amputating saws	384
BRAND , tendon seizing instruments	464	CHEATLE , sterilizing forceps	564
BRAUN-STADLER , episiotomy scissors	121	CHERON , dressing forceps	234
BRIDGE , dissecting and ligature forceps	34	CHILDE , suture forceps	225
BRODIE , probes	311	Chisels	417-426
Bronchus forceps	30	CHRIS-TROUTMAN , blade breakers	177
BROPHY (SULLIVAN) , fine scissors	123	CHURCH , scissors	117
BROPHY , dressing and tissue forceps	63	Cilia forceps	76
BROWN , needle holders	183	Clamps, tubing	53
BROWN , tissue forceps	64	CLAR 55 , head lamps	368
BROWN-ADSON , tissue forceps	60	CLAR STANDARD , head lamps	368
BROWNE-DENIS , abdominal retractors	301	CLASSON , scissors	117
BRUNNER , ligature conductors	220	CLAUS , ligature needles	218
BRUNNER , ligature needles	216, 217	CLAUS-EICKEN , ligature needles	219
BRUNNER , retractors	263	Cleaning brushes	583-589
BRUNNER , stomach and intestinal clamp forceps	520	CLEVELAND , bone cutting forceps	478
BRUNNER-FERROZELL , ligature conductors	222	CLEVELAND , bone rongeurs	468
BRUNS , bone curettes	434, 437	CLEVELAND-GARDNER , bone cutting forceps	477
BRUNS , plaster-of-Paris shears	134	Clips	496
BRYANT , sponge holding forceps	228	Clips, suture	225
BUCK , ligature scissors	129	Clothing scissors	132, 133
BUCK , percussion hammers	369	CLOWARD HIBBS SPRATT , bone curettes	437
BUELAU , trocars	328	COAKLEY , trocars	330
Bulldog Clamps	10, 11	COBB , bone curettes	439
BUNNELL , hand drills	388	COBB , chisels	424
BUNNELL , tendon stripper	465	COBB , elevators	449
BUSCH , umbilical scissors	121	COGSWELL , suction tubes	336
BYRD , suction tubes	332	COLIBRI (BARRAQUER-KATZIN) , iris forceps	82

	Page		Page
COLLER , artery forceps	17	DAHMEN , osteotomes	425
COLLIER , needle holders	180	DANDY , scalp flap forceps	26
COLLIN , abdominal retractors	304, 305	DANDY , scissors	115
COLLIN , amputating knives	172	DARLING , selfretaining retractors	295
COLLIN , dressing forceps	234	DAVIDSON , retractors	276
COLLIN , dynamometers	374	DAVIS-RAGNELL , delicate retractors	250
COLLIN , mallets	429	DE BAKEY (MAYO-HEGAR-DELICATE) , needle holders TUC	192
COLLIN , operating knives	170	DE BAKEY , dissecting forceps tungsten TUC	94
COLLIN , scalpel handles	166	DE BAKEY , non-traumatic tissue forceps	91
COLLIN , seizing forceps	13	DE BAKEY , scissors	113, 116
COLLIN , suture forceps	224	DE BAKEY , scissors tungsten TUC	157
COLLIN-BABY , abdominal retractors	304	DE BAKEY , suction tubes	331
COLLIN-DUVAL , grasping forceps	66	DE BAKEY , vascular dilators	314
COLLIN-HARTMANN , retractors	277	DE LA ROZA , ligature needles	217
Comb	564	DE MARTEL-POTTS , scissors	116
Conductors, ligature	220-222	DE MARTEL-WOLFSON , anastomosis clamps	532, 533
CONE , selfretaining retractors	292	DE MARTEL-WOLFSON , intestinal clamp forceps	532, 533
Connecting pieces	349	DEAN , gum scissors	136
CONVERSE , needle holders tungsten TUC	195	DEAN , scissors tungsten TUC	162
CONVERSE-DERF , needle holders	180	DEAN-DELICATE , gum scissors	136
COOLEY , suction tubes	333	DEAVER , operating scissors	104
COOLEY , vascular dilators	313	DEAVER , retractors	269-271
COOPER , ligature needles	216	DEJERINE , percussion hammers	370
CORNEAL (TROUTMAN) , iris forceps	82	Delicate artery forceps	22
Corneal scissors	141-143	Delicate hooks	242-250
Corneal section scissors	142	Delicate retractors	250
Coronary scissors	115	DEMEL , wire twisting instruments	407
CORWIN , wire forceps TUC	403	DENIS-BROWNE , abdominal retractors	301
CORWIN , wire twisting forceps tungsten TUC	203	DERF , needle holders	180
CORYLLOS , retractors	274	DERF , needle holders tungsten TUC	195
COTTLE KAZANJIAN , bone cutting forceps	477	DERF-CONVERSE , needle holders	180
COTTLE , mallets	428	Dermatomes	176
COTTLE , nasal scissors	120	DESCHAMPS , needles	215
COTTLE , nose dressing forceps	77	DESJARDINS , gall duct forceps	40
Cotton and dressing pliers	95-97	DESMARRES , chalazion forceps	88
Cotton applicators	311, 312	DESMARRES , delicate retractors	248
COUPLAND , suction tubes	332	Diagnostic Sets	380, 381
COUPLAND , suction tubes	337	Diagnostics	367-382
Cover glass forceps	78	DICK , anastomosis forceps	528
CRAFOORD , bronchus forceps	30	DIEFFENBACH , abscess knives	174
CRAFOORD , scissors	118	DIEFFENBACH , bulldog clamps	11
CRAFOORD-SELLORS , auricle forceps	29	DIEFFENBACH , operating knives	170, 171
CRANE-KAPLAN , pocket markers	98	DIETRICH , micro needle holders tungsten TUC	205
CREGO , bone levers	398	DIETRICH-HEGEMANN , scissors	114
CRILE , artery forceps	17	Dilators, vascular	313, 314
CRILE , needle holders	187	DINGMANN , cartilage forceps	453
CRILE-MURRAY , needle holders	182	DIPLOMAT , blood pressure manometers	379
CRILE-RANKIN , artery forceps	17	Dissecting, ligature forceps	23-25, 29, 31-36
CRILE-WOOD , needle holders	182	Dissecting, scissors	108-112
CRILE-WOOD , needle holders tungsten TUC	196	Dissection , micro scissors	145, 147
CRILE-WOOD-BABY , needle holders	182	DIXON-LOVELACE , artery forceps	26
CRILE-WOOD-BABY , needle holders tungsten TUC	196	DOUGLAS , cilia forceps	76
Crown scissors	130, 131	DOUGLAS , trocars	330
CULLEN-WERTHEIM , hysterectomy forceps	44	DOUGLAS-BOZEMANN , dressing forceps	233
Curettes	434-441	DOYEN , abdominal retractors	302
CUSHING , delicate hooks	244	DOYEN , mallets	428
CUSHING , delicate retractors	248	DOYEN , needle holders	180
CUSHING , dissecting forceps tungsten TUC	93	DOYEN , Non-traumatic stomach and intestinal forceps	524
CUSHING , dressing and tissue forceps	62	DOYEN , probes	310
CUSHING , flat drill	387	DOYEN , raspatories	445
CUSHING , spinal retractors	250	DOYEN , retractors	267
CUSHING-TAYLOR , dissecting forceps tungsten TUC	93	DOYEN , scissors	106
Cuticle scissors	135	DOYEN , stomach and intestinal clamp forceps	520, 524
CZERNY , rectal specula	534	DOYEN , towel forceps	51
CZERNY , retractors	279	DOYEN-STILLE , retractors	266
D		Dressing	318-324
DAHMEN , chisels	425	Dressing and tampon forceps	78
		Dressing forceps	57-65, 229-239
		Drill bit for bone screws	513

	Page		Page
DUBOIS , scissors	107	Fine scissors	122-124
DUEHRSSSEN , dressing and tissue forceps	64	Finger retractor	283
DUNHILL , artery forceps	22	Finger ring saws	482
DUPLAY , polypus forceps	236	FINOCCHIETTO , kidney pedicle clamp forceps	37
DUPLEX-LIGHTWEIGHT/BABY , stethoscopes	378	FINOCCHIETTO , needle holders	185
DURANTE , grasping forceps	68	FINOCCHIETTO , needle holders tungsten TUC	197
DUVAL , grasping forceps	68	FINOCCHIETTO , scissors	118
DUVAL , intestinal tissue forceps	519	FINSEN , selfretaining retractors	283
DUVAL-COLLIN , grasping forceps	66	FISCHER-ARLT , iris forceps	80
Dynamometer	374	Fistula knives	174
DYNAMOMETER III	374	Fistula scissors	106
E		Fixation forceps	84
Ear dressing forceps	77	FLAGG , cotton and dressing pliers	96
EASTMAN-RICHARDSON , retractors	264	Flat nose pliers	404
EATON-BECKMANN , selfretaining retractors	293	FLETCHER , sponge holding forceps	232
ECHLIN , bone rongeurs	474	FOERSTER , iris forceps	81
ECONOM , diagnostic sets	380	FOERSTER-BALLENGER , sponge holding forceps	237
EICKEN , trocars	330	FOMON , dissecting scissors	111
EICKEN-CLAUS , ligature needles	219	FOMON , nasal scissors	119
EICKEN-KILLIAN , suction tubes	335	Forceps	57-98
EISELSBERG , ligature scissors	128	Forceps, anterior chamber	85
Elevators	447-449, 481	Forceps, artery	13-23, 25-28
ELSCHNIG , fixation forceps	84	Forceps, articulating paper	98
ENGEL , plaster saw	318	Forceps, auricle	29
ENGL. MODELL , towel forceps	51	Forceps, bronchus	30
Enterotomy scissors	118	Forceps, capsular	83
Entropium forceps	88	Forceps, catheter	360
Episiotomy scissors	121	Forceps, chalazion	88, 89
ERHARDT , entropium forceps	88	Forceps, cilia	76
ESMARCH , bandage scissors	134	Forceps, cotton and dressing pliers	95-97
ESMARCH , plaster knives	318	Forceps, cover glass	78
EUFRATE-PASQUE , microvascular needle holders TUC	193	Forceps, dissecting and ligature	23-25, 29, 31-36
EWALD , dressing and tissue forceps	60	Forceps, dressing	57-65, 229-239
EXCENTRIC-LISTER , bandage scissors	133	Forceps, ear and nose dressing	77
Extension bows	399, 400	Forceps, entropium	88
Eye scissors	125-127, 138-143	Forceps, fixation	84
F		Forceps, grasping	66-68, 70, 316
Facelift markers	376	Forceps, haemorrhoidal	47, 48
Face-lift scissors TUC	161	Forceps, haemorrhoidal atraumatic	48
FALK , ligature needles	219	Forceps, hysterectomy	41-45
FARABEUF , bone holding forceps	458	Forceps, iris	79-82
FARABEUF , raspatories	443	Forceps, jeweler's	69
FARABEUF , retractors	278	Forceps, kidney pedicle clamp	37-39
FARABEUF-LAMBOTTE , bone holding forceps	458	Forceps, muscular	87, 88
FARREL , cotton applicators	311	Forceps, non-traumatic vascular tissue	91
FAULKNER , lens holding forceps	90	Forceps, parametrium	46
FAURE , hysterectomy forceps	45	Forceps, peritoneal clamp	49, 50
FAURE , peritoneal clamp forceps	50	Forceps, plaster cast bending	320
FAVALORO , scissors	115	Forceps, polypus	229-239
FEHLAND , stomach and intestinal clamp forceps	527	Forceps, seizing	12, 13
FEILCHENFELD , splinter forceps	73	Forceps, setting	11
FEIN , cotton applicators	312	Forceps, splinter	73-75
FERGUSSON , angiotribes	47	Forceps, sponge holding	228-239
FERGUSSON , bone holding forceps	455	Forceps, suture	85, 86, 224, 225
FERGUSSON , operating scissors	104	Forceps, tampon	78
FERGUSSON , suction tubes	335	Forceps, tissue	57-65, 67, 68
FERREIRA , retractors	280	Forceps, tissue seizing	9
FERRIS-SMITH , tissue forceps	65	Forceps, tonsil hemostatic	27
FERROZELL , ligature conductors	222	Forceps, towel	51, 52
FERROZELL-BRUNNER , ligature conductors	222	Forceps, tungsten TUC	92-94
FERROZELL-KIRSCHNER , ligature conductors	222	Forceps, wire twisting tungsten TUC	203
Fibre optic laryngoscopes	357-360	FOREGGER (WISCONSIN) FIBRE OPTIC , laryngoscopes	358
FIBRE OPTIC , fibre optic laryngoscopes	360	FOREGGER (WISCONSIN) , laryngoscopes	354
Fibre optice carriers	363	FOX , bone curettes	436
Fine artery forceps	15	FOX-GOLDMAN (SPECIAL) , gum scissors	136
		FOX-GOLDMAN , gum scissors	136
		FOX-GOLDMAN , scissors tungsten TUC	161
		Fracture pins	496
		FRANKENFELDT , grasping forceps	316

	Page		Page
FRANZ , abdominal retractors	302	HALSEY , needle holders	181
FRAZIER , delicate hooks	242	HALSEY , needle holders tungsten TUC	195
FRAZIER , suction tubes	335	HALSTED , artery forceps	16
FREER , elevators	448	HALSTED-MOSQUITO , artery forceps	15
FRENCH-EYE/RYDER , needle holders tungsten TUC	193	Hammers, percussion	369, 370
FRIEDMAN , bone rongeurs	468	Hand Drills	385-390
FRIEDRICH , ligature instruments	223	Hand surgery retractors	285
FRITSCH , retractors	266	Handles for Liposuction and infiltration cannulae	338, 340
FRYKHOLM , bone rongeurs	474	HARMAN-BISHOP , iris forceps	82
FUCHS-GILL , iris forceps	83	HARMS , suture forceps	86
FULTON , scissors	117	HARRINGTON , retractors	267
G			
Gall duct forceps	37, 40	HARRISON (PYE-SMITH) , sterilizing forceps	564
GARRETT , vascular dilators	313	HARTMANN , artery forceps	14
GEISSENDOERFER-OVERHOLT , dissecting and ligature forceps	23	HARTMANN , bone rongeurs	469
GELPI , selfretaining retractors	294	HARVEY , wire cutting scissors	130
GEMINI , dissecting and ligature forceps	35	HATFIELD , bone curettes	439
GERALD , dissecting and tissue forceps	62	Head lamps	368
GERSTER , bone holding clamps	394	Head mirrors	367
GERSTER-LOWMAN , bone holding clamps	394	HEANEY , hysterectomy forceps	43
GILL , Capsular forceps	83	HEANEY , needle holders	184
GILL-FUCHS , iris forceps	83	HEANEY , retractors	277
GILL-HESS , iris forceps	82	HEANEY-BALLANTINE , hysterectomy forceps	43
GILLIES , delicate hooks	242	HEANEY-KANTER , hysterectomy forceps	43
GILLIES , dissecting forceps tungsten TUC	92	HEANEY-REZAK , hysterectomy forceps	44
GILLIES , needle holders	185	HEATH , ligature scissors	129
GILLIES , needle holders tungsten TUC	198	HEATH-RICHTER , suture forceps	224
GILLIES , tissue forceps	67	HEGAR-MAYO , needle holders	184
GILLS-WELSH , capsulotomy scissors	140	HEGAR-MAYO , needle holders tungsten TUC	192
GIL-VERNET , delicate retractors	249	HEGAR-MAYO-DELICATE (DE BAKEY) , needle holders TUC	192
GOELET , retractors	279	HEGAR-MAYO-DELICATE , needle holders	184
Goitre enucleation scissors	119	HEGAR-OLSEN , needle holders	185
GOLDMAN-FOX (SPECIAL) , gum scissors	136	HEGAR-OLSEN , needle holders tungsten TUC	198
GOLDMAN-FOX , gum scissors	136	HEGEMANN-DIETRICH , scissors	114
GOLDMAN-FOX , scissors tungsten TUC	161	HEGENBARTH , suture forceps	224
Goniometers	373	HEIFETZ , grasping forceps	70
GOOD , tonsil scissors	119	HEISS , artery forceps	30
GOOD-SCHWECKENDICK , tonsil scissors	119	HELFERICH-BIER , amputating saws	384
GORNEY , dissecting scissors	111	HEMINGWAY , bone curettes	441
GOSSET , abdominal retractors	298	HENAHAN , thir molar hook	481
GRADLE , cilia forceps	76	Hemostats	9-53
Graduated Measures	556, 559	HENLEY , selfretaining retractors	288
GRAEFE , delicate hooks	243	HENNIG , plaster cast spreader	319
GRAEFE , eye scissors	126	HERRICK , kidney pedicle clamp forceps	39
GRAEFE , fixation forceps	84	HESS , iris forceps	81
GRAEFE , iris forceps	79	HESSBERG , ligature needles	217
Grasping forceps	66-68, 70, 316	HESS-GILL , iris forceps	82
GRAY , gall duct forceps	40	HEYMANN , nasal scissors	120
GRAZIL , operating scissors	103	HEYWOOD-SMITH , sponge holding forceps	236
GREEN , fixation forceps	84	HIBBS , chisels	420
GREEN-SENN , delicate retractors	247	HIBBS , osteotomes	420
GROSS-MAIER , polypus forceps	230, 231	HIRSCHMANN , anoscopes	539
GRUENWALD (JANSEN) , nose dressing forceps	78	HOEN , elevators	448
GRUENWALD , nose dressing forceps	78	HOESEL , needle holders	188
Guide needles	346	HOESEL , needle holders tungsten TUC	201
Gum scissors	136, 137	HOESEL , retractors	265
GUTHRIE , delicate hooks	246	HOHMANN , bone levers	396, 397
GUYON , kidney pedicle clamp forceps	38, 39	HOKE , osteotomes	417
GUYON-ARTRAUMATIC , kidney pedicle clamp forceps	39	HOLINGER , laryngoscopes	362
Gynecological scissors	105-107	Hooks, delicate	242-250
H			
HABERER , abdominal spatulas	308	HOPKINS , plaster knives	318
Haemorrhoidal ligators	552-554	HOPKINS-JOHNS , bulldog clamps	11
HAJEK , mallets	429	HOPKINS-JOHNS , dissecting and ligature forceps	32
HALLE , nasal scissors	120	HOPKINS-JOHNS , setting forceps	11
		HORNE-JOBSON , cotton applicators	312
		HOSPITAL-PROVIDENCE , artery forceps	16
		HRYNITSCHAK-YOUNG , boomerang needle holders	189
		HUDSON , hand drills	387
		HUMBY , dermatomes	176
		HUNT , grasping forceps	70

	Page		Page
HUNTER , splinter forceps	73	KELLY , retractors	268
HURD , ligature needles	218	KELLY , scissors	106
Hysterectomy forceps	41-45	KELLY , scissors tungsten TUC	153
I		KELLY , sponge holding forceps	235
Incision scissors	104	KELLY-RANKIN , artery forceps	17
Instrument boxes	562	KELMAN-McPHERSON , suture forceps	85
Instrument Storing Tray	561	KERN , bone holding forceps	456
Instruments for Küntscher nails	488, 489	KERSTING , anastomosis forceps	528
Intestinal and anastomosis clamp forceps	532, 533	Kidney pedicle clamp forceps	37-39
Intestinal and stomach clamp forceps	520-523	Kidney tray	559
Intestinal and stomach crushing clamps	530	KILNER (RAGNELL) , scissors	112
Intramedullary pins	495	KILNER , delicate hooks	242
IOWA , special needles	345	KILNER , needle holders	181
Iridectomy scissors	138	KILNER , needle holders tungsten TUC	195
Iris forceps	79-82	KIRBY , iris forceps	82
Iris scissors	125, 138	KIRSCHNER , abdominal retractors	303
ISRAEL , retractors	253	KIRSCHNER , extension bows	400
IVES-FANSLER , sphincteroscopes	538	KIRSCHNER , ligature conductors	222
IWANSON , circle	375	KIRSCHNER , suction tubes	503
J		KIRSCHNER , wires	499-502
JACKSON , fibre optic laryngoscopes	363	KIRSCHNER-FERROZELL , ligature conductors	222
JACKSON , tampon forceps	78	KLEINERT-KUTZ , bone rongeurs	471
JACOBI , ligature needles	217	KLEINERT-KUTZ , delicate hooks	242
JACOBS CHUCK , hand drills	388	KLEINERT-KUTZ , tendon seizing instruments	464
JACOBSON , micro needle holders	210	KLIMA-ROSSEGGER , biopsy needles	343
JACOBSON , micro needle holders tungsten TUC	204	KLINIKUM BERLIN , tubing clamps	53
JACOBSON , needle holders	182	KLINKENBERGH-LOTH , scissors	117
JACOBSON , needle holders tungsten TUC	194	KNAPP , delicate hooks	246
JAMESON , caliper	372	Knee retractors	466
JAMESON , muscular forceps	87	KNIGHTON , selfretaining retractors	297
JAMESON , needle holders	184	Knives, abscess	174
JANET , syringes	348	Knives, amputating	172
JANSEN , bone curettes	440	Knives, brain	173
JANSEN , nose dressing forceps	77	Knives, fistula	174
JANSEN , self-retaining retractors	284	Knives, operating	169-171
JANSEN-GRUENWALD , nose dressing forceps	78	Knives, plaster	318
Jars	562	Knives, post mortem	173
JEWELER , dissecting forceps tungsten TUC	92	Knives, transplantation	175
Jeweler's forceps	69	Knot-Tiers	223
JOBSON-HORNE , cotton applicators	312	KNOWLES , bandage scissors	133
JOHANSSON , trocars	329	KOCHER , ligature conductors	222
JOHNS-HOPKINS , bulldog clamps	11	KOCHER , ligature needles	216
JOHNS-HOPKINS , dissecting and ligature forceps	32	KOCHER , Non-traumatic stomach and intestinal forceps	525
JOHNS-HOPKINS , setting forceps	11	KOCHER , retractors	260, 266
JONES , towel forceps	51	KOCHER , retractors	251, 260, 266
JOSEPH , delicate hooks	246	KOCHER , stomach and intestinal clamp forceps	522, 525
JOSEPH , dissecting scissors	112	KOCHER-DELICATE , artery forceps	22
JUDD-ALLIS , tissue seizing forceps	518	KOCHER-LANGENBECK , retractors	259
K		KOCHER-OCHSNER , artery forceps	20, 21
KADER , retractors	273	KOERTE , retractors	252, 267
KALT , micro needle holders	212	KÖNIG , ligature conductors	221
KALT , micro needle holders tungsten TUC	205	KÖNIG , nail splitting scissors	135
KALT-ARRUGA , micro needle holders	212	KRAUSE , trocars	330
KALT-CASTROVIEJO , needle holders	212	KROENLEIN , seizing forceps	13
KANTER-HEANEY , hysterectomy forceps	43	KRONECKER , ligature needles	218
KANTROWITZ , dissecting and ligature forceps	35	KUEHNE , cover glass forceps	78
KAPLAN-CRANE , pocket markers	98	KÜNTSCHER , instruments for nails	488, 489
KATZIN , corneal scissors	142	KÜNTSCHER , intramedullary nails	492-494
KATZIN-BARRAQUER , corneal scissors	142	KUTZ-KLEINERT , delicate hooks	242
KAYE , Face-lift scissors TUC	161	L	
KELLY (RICHARDSON) , retractors	264	LA GRANGE , eye scissors	126
KELLY , artery forceps	17	LAHEY , gall duct forceps	37
KELLY , proctoscopes	540, 541	LAHEY , retractors	263
		LAMBOTTE , bone holding forceps	460
		LAMBOTTE , osteotomes	426
		LAMBOTTE , raspatories	443
		LAMPERT , chalazion forceps	89

	Page		Page
LANDAU , trocars	329	LOCKLIN , gum scissors	136
LANDAU-SEGOND , hysterectomy forceps	45	LOCKLIN , scissors tungsten TUC	162
LANDGRAF , cotton and dressing pliers	97	LOCKWOOD , tissue seizing forceps	518
LANDOLT , fine scissors	124	LOCKWOOD-ALLIS , tissue seizing forceps	518
LANE , bone holding forceps	457	LONDON COLLEGE , cotton and dressing pliers	95
LANE , screw drivers	491	LONG , hysterectomy forceps	44
LANE , stomach clamp forceps	531	Loop Twisters	223
LANE , tissue forceps	61	LORENZ , bandage scissors	133
LANE , towel forceps	51	LORNA , towel forceps	52
LANGE , clothing scissors	132	LOTH-KLINKENBERGH , scissors	117
LANGE , suture forceps	225	LOTH-SCHOEMAKER , ligature scissors	128
LANGE-HOHMANN , bone levers	397	LOUTE , wire twisting instruments	407
LANGENBECK , amputating knives	172	LOVELACE-DIXON , artery forceps	26
LANGENBECK , bone holding forceps	455	LOWER , gall duct forceps	37
LANGENBECK , elevators	447	LUCAE , mallets	430
LANGENBECK , needle holders	188	LUCAE , nose dressing forceps	77
LANGENBECK , needle holders tungsten TUC	202	LUCAS , bone curettes	441
LANGENBECK , raspatories	443	LUCAS , chisels	417
LANGENBECK , resection saws	384	LUER , bone rongeurs	469
LANGENBECK , retractors	254, 258	LUER , haemorrhoidal forceps atraumatic	48
LANGENBECK-DELICATE , needle holders tungsten TUC	202	LUER , suction tubes	336
LANGENBECK-KOCHER , retractors	259	LUETHY-BECK , needle holders tungsten TUC	202
LANGENBECK-MINI , delicate retractors	247		
LANGENBECK-PARKER , retractors	278	M	
LANGENBECK-RYDER , needle holders tungsten TUC	202	MAGILL , catheter forceps	360
Laryngoscopes	353-360	MAIER-SIMS , polypus forceps	239
Laryngoscopes, fibre optic	357-360	Mallets	427-433
LAWRENCE , dissecting and ligature forceps	34	MARKHAM-MEYERDING , selfretaining retractors	294
Lead Hands	482	MARKWALDER , bone cutting forceps	477
LEKSELL-STILLE , bone rongeurs	473	MARQUARDT , bone rongeurs	470
LEMPERT , bone rongeurs	470	MARTEL , scalp flap forceps	12
Lens holding forceps	90	MARTEL-WILLET , scalp flap forceps	12
LERICHE , artery forceps	16	MARTIN , cartilage forceps	453
LESTER , fixation forceps	84	MARTIN , retractors	262
LEWIN , bone holding forceps	454	MARTIN-CARTILAGE , scissors	118
LEXER , chisels	422, 423	MARTINI , bone curettes	440
LEXER , osteotomes	422, 423	MASS.-GENERAL-HOSPITAL (M.G.H.) , needle holders	183
LEXER , scissors	111	MASSE-ROBIN , abdominal retractors	306
LEXER , scissors tungsten TUC	158	MASSON , needle holders	184
LEXER-BABY , scissors	111	MASSON , needle holders tungsten TUC	197
LICHTENBERG , needle holders	187	MATHIEU , needle holders	186
LICHTENBERG , needle holders tungsten TUC	201	MATHIEU , needle holders tungsten TUC	199
LICHTWITZ , trocars	330	MATHIEU , rectal specula	536
Ligature and dissecting forceps	23-25, 29, 31-36	MATHIEU , retractors	278
Ligature Catcher	223	MATHIEU-DELICATE , needle holders	186
Ligature conductors	220-222	MATHIEU-DELICATE , needle holders tungsten TUC	199
Ligature scissors	128, 129	MATHIEU-RYDER VASCULAR , needle holders tungsten TUC	200
Ligature, instruments	223	MATHIEU-RYDER , needle holders tungsten TUC	200
Ligature, needles	215-219	MATSON , raspatories	446
LINCOLN , scissors	117	MAYFIELD , bone rongeurs	470
LINDEMANN , resection saws	384	MAYO ROBSON , Non-traumatic stomach and intestinal forceps	526
Liposuction and infiltration cannulae	339, 341, 342	MAYO , safety pins	564
LISTER , bandage scissors	133, 134	MAYO , scissors	105
LISTER , dressing forceps	228	MAYO , scissors tungsten TUC	153
LISTER , scissors tungsten TUC	162	MAYO-ADAMS , selfretaining retractors	296
LISTER-EXCENTRIC , bandage scissors	133	MAYO-HARRINGTON , scissors	105
LISTON , amputating knives	172	MAYO-HEGAR , needle holders	184
LISTON , bone cutting forceps	477, 480	MAYO-HEGAR , needle holders tungsten TUC	192
LISTON-KEY , bone cutting forceps	479	MAYO-HEGAR-DELICATE (DE BAKEY) , needle holders TUC	192
LITTAUER , cilia forceps	76	MAYO-HEGAR-DELICATE , needle holders	184
LITTAUER , ligature scissors	128	MAYO-NOBLE , scissors	105
LITTAUER , nail nippers	569	MAYO-ROBSON , stomach and intestinal clamp forceps	521, 526
LITTAUER-LISTON , bone cutting forceps	477	MAYO-RUSS. , grasping forceps	66
LITTLE , retractors	263	MAYO-STILLE , scissors	105
LITTLER , fine scissors	123	MAYO-STILLE , scissors tungsten TUC	154
LITTLEWOOD , tissue seizing forceps	518	MC GIVNEY , haemorrhoidal ligators	553
LLOYD-DAVIS , anastomosis forceps	529	MC INDOE , bone cutting forceps	478
Lobectomy scissors	118	MC INDOE , dressing forceps	60
LOCKHART-MUMMERY , probes	311		

	Page		Page
MC INDOE , scissors	118	MOD. USA , dressing and tissue forceps	59
MC INTOSH FIBRE OPTIC , laryngoscopes	357	MOD. USA , plaster cast spreader	319
MC INTOSH , laryngoscopes	353	MOD. USA , umbilical scissors	121
McDONALD , capsulorhexis forceps	90	MOD. USA/SMITH , bandage scissors	133
McDONALD , elevators	448	MOD. WIEN , ligature instruments	223
McPHERSON , suture forceps	85	MODELL TÜBINGEN , retractors	262
McPHERSON-KELMAN , suture forceps	85	MOELTGEN , goniometers	373
MEAD , bone rongeurs	469	MOLDESTAD , delicate hooks	244
MEAD , mallets	430	MOLLISON , selfretaining retractors	289
Measuring instruments	371-375	MOLT , raspatories	444
MEEKER , dissecting and ligature forceps	25	MOORE , hand drills	387
MENGHINI , biopsy needles	344	MOORFIELD , suture forceps	84
Meniscotomy knives	467	MORGAN , anoscopes	541
Meniscus and cartilage forceps	453	MORGAN , fibre optic	541
MERIAM , cotton and dressing pliers	96	MORRIS , retractors	261
METZENBAUM , needle holders tungsten TUC	199	MOSQUITO-HALSTED , artery forceps	15
METZENBAUM , scissors	108	MOSQUITO-MICRO , artery forceps	15
METZENBAUM , scissors tungsten TUC	155, 156	MOYNIHAN , hysterectomy forceps	44
METZENBAUM-BABY , scissors	108	Multiple approach retractor	282
METZENBAUM-DELICATE , scissors	110	MUMMERY-LOCKHART , probes	311
METZENBAUM-DELICATE , scissors tungsten TUC	158-160	Muscular forceps	87
METZENBAUM-NELSON , scissors	109	MYRTLE LEAF , probes	310
MEYERDING , delicate retractors	247		
MEYERDING , retractors	273	N	
MEYERDING , selfretaining retractors	294	NABATOFF , varicose vein probe set	312
MEYERDING-MARKHAM , selfretaining retractors	294	NAGER , ligature needles	219
MICHEL , suture clips	225	Nail -files	579
MICHEL , suture forceps	224	Nail nippers	568-570
Micro forceps	71, 72	Nail scissors	135
Micro needle holders	204-213	Nail splitting scissors	135
Micro needle holders tungsten TUC	204, 205	Nails	492-498
Micro needle holders with pen-type handle	206-209	Nasal scissors	119, 120
Micro scissors	143-149	Needle holders	180-213
MICRO WULLSTEIN , suction tubes	335	Needle holders, boomerang	189
MICRO-ADSON , dressing and tissue forceps	59	Needle holders, micro	204-213
MICRO-FRIEDMAN , bone rongeurs	476	Needle holders, tungsten TUC	192-205
MICRO-MOSQUITO , artery forceps	15	Needle Sterilizing Cases	560
MICRO-RYDER , needle holders tungsten TUC	193	Needles, biopsy	343, 344
MICROVASCULAR , needle holders TUC	193	Needles, Deschamps	215
MIDDLEDORPF , retractors	264	Needles, guide	346
MIKULICZ , peritoneal clamp forceps	49	Needles, ligature	215-219
MIKULICZ , retractors	268	Needles, Reverdin	214
MIKULICZ-BABY, peritoneal clamp forceps	49	NEFF , meniscotomy knives	467
MILLER FIBRE OPTIC , laryngoscopes	359	NEGUS , gall duct forceps	40
MILLER , articulating paper forceps	98	NEIVERT , needle holders	181
MILLER , laryngoscopes	355	NEIVERT , needle holders tungsten TUC	195
MILLER-SENN , delicate retractors	250	NELATON , probes	310
MILLIGAN , selfretaining retractors	288	NELSON , grasping forceps	66
MILLS , scissors	116	NELSON , trocars	328
MINI , scalpel blades	167	NELSON-METZENBAUM , scissors	109
MINI , scalpel handles	167	Nerve dissecting scissors	111
MINI-FRIEDMAN , bone rongeurs	468	Nerve , micro scissors	147
MINI-HOHMANN , bone levers	395	NEUMANN , gum scissors	137
MINI-LAMBOTTE , osteotomes	426	Neuro surgery scissors	115-117
MINI-LANGENBECK , delicate retractors	247	NEW ORLEANS , needle holders	183
MINI-LEXER , chisels	422	NEW ORLEANS , needle holders tungsten TUC	194
MINI-LEXER , osteotomes	422	NIRO , wire forceps	401
MISKIMON , selfretaining retractors	289	NOBLE-MAYO , scissors	105
Mixing bowls	559	Non-traumatic stomach and intestinal clamp forceps	524-527
MIXTER , dissecting and ligature forceps	33, 34	Non-traumatic vascular tissue forceps	91
MIXTER , operating scissors	104	nopa PROFI , post mortem saw	484
MIXTER-BABY , dissecting and ligature forceps	33	NORTHBENT , ligature scissors	129
MIXTER-O'SHAUGNESSY , dissecting and ligature forceps	33	Nose dressing forceps	77, 78
MIXTER-OVERHOLT , dissecting and ligature forceps	29	NOTO , sponge holding forceps	234
MOD. BONN , suture forceps	86	NOYES , iris scissors	138
MOD. BONN , fine scissors	124	NUSSBAUM , stomach and intestinal clamp forceps	523
MOD. BONN , iris scissors	81		
MOD. TÜBINGEN VANNAS , secondary cataract scissors	139	O	
MOD. TÜBINGEN , suture forceps	86		

	Page		Page
O'BRIAN , fine scissors	124	PLESTER , selfretaining retractors	295
OBWEGESER , ramus retractors	257	PLESTER , suction tubes	335
OBWEGESER , soft tissue retractors	255, 256	Pocket markers	98
OCHSNER , trocars	329	Podiatry	568-579
OCHSNER-KOCHER , artery forceps	20, 21	Polypus forceps	229-239
O'CONNOR , delicate hooks	243	POOLE , suction tubes	332
O'CONNOR-O'SULLIVAN , abdominal retractors	301	POOLE-BABY , suction tubes	332
OEHLER , dissecting forceps tungsten TUC	92	Post mortem knives	173
OLIVECRONA , scissors	117	Post mortem saw	483-485
OLLIER , retractors	253	POTTS-DE MARTELL , scissors	116
OLSEN-HEGAR , needle holders	185	POTTS-SMITH , dissecting forceps tungsten TUC	92
OLSEN-HEGAR , needle holders tungsten TUC	198	POTTS-SMITH , dressing and tissue forceps	63
OLSEN-HEGAR-USA , needle holders tungsten TUC	198	POTTS-SMITH , micro needle holders	212
OMBREDANNE , mallets	427	POTTS-SMITH , micro needle holders tungsten TUC	205
Operating knives	169-171	POTTS-SMITH , scissors for vascular surgery	113, 115
Operating scissors	102-105, 122	POTTS-SMITH , scissors tungsten TUC	157
Optical retractor	281, 282	PRATT , fistula probe	311
OSCINOPA , electric plaster saw	321	PRATT , haemorrhoidal forceps	47
OSCINOPA , post mortem saw	483	PRATT , rectal specula	536
O'SHAUGNESSY-MIXTER , dissecting and ligature forceps	33	PRECISA , blood pressure manometers	379
Osteotomes	417-426	PRESBYTERIAN , tubing clamps	53
O'SULLIVAN-O'CONNOR , abdominal retractors	301	PRINCE , muscular forceps	87
OTOSKOP UNI , diagnostic set	381	PRINCE , tonsil scissors	119
OVERHOLT , dissecting and ligature forceps	24	Probes	310, 311
OVERHOLT-BABY , dissecting and ligature forceps	23	Proctoscopes	537-543
OVERHOLT-GEISSENDOERFER , dissecting and ligature forceps	23	Protecting forceps	390
OVERHOLT-MIXTER , dissecting and ligature forceps	29	PROVIDENCE-HOSPITAL , artery forceps	16
		Puncture/Special Needles	327-349
P		PUTTI , rasps	451
PALMER , fracture clips	496	PYE-SMITH (HARRISON) , sterilizing forceps	564
PARAMETRIUM , parametrium forceps	46	PYNCHON-ANDREWS , suction tubes	331
PARAMETRIUM , scissors tungsten TUC	154		
PARKER , retractors	278	Q	
PARKER-LANGENBECK , retractors	278	QUINBY , gum scissors	137
PARTSCH , chisels	418	QUINKE , biopsy needles	344
PARTSCH , mallets	430		
PATON , micro needle holders	212	R	
PAUFIQUE , suture forceps	86	RABINER , percussion hammers	369
PAYR , intestinal and stomach crushing clamps	530	RADOLF , nail forceps	482
PAYR , ligature conductors	221	RAGNELL (KILNER) , scissors	112
PAYR-BABY , intestinal and stomach crushing clamps	530	RAGNELL-DAVIS , delicate retractors	250
PAYR-SCHMIEDEN , ligature conductors	221	RALK , hand drills	389
PEAN , seizing forceps	13	RALK , splinter forceps	75
PEAN-DELICATE , artery forceps	22	RAMPLEY , sponge holding forceps	238
PEAN-ROCHESTER , artery forceps	18, 19	Ramus retractors	257
PEERS , towel forceps	52	RANKIN-CRILE , artery forceps	17
PEET , splinter forceps	75	RANKIN-KELLY , artery forceps	17
PELKMANN , dressing forceps	235	Raspatories	442-446
PENNINGTON , seizing forceps	13	Rasps	451
Percussion hammers	369, 370	Razor Blades	177
PERCY , amputation shield	463	Rectal biopsy forceps	551
Peritoneal clamp forceps	49, 50	Rectal Specula	534-536
PERRY , cotton and dressing pliers	97	Rectoscopes	544-550
PERTHES , hand drills	390	REHN , transplantation knives	175
PHANEUF , hysterectomy forceps	45	REILL , micro needle holders	207
PHILIPS , screw drivers	491	REINER , plaster knives	318
PIERCE , trocars	330	Reposition forceps	487
PIFFARD , bone curettes	436	RESANO , stomach and intestinal clamp forceps	527
PINARD , stethoscopes	377	Resection and amputating saws	384
Plaster cast bending forceps	320	Retractors	242-308
Plaster cast spreaders	319	Retractors with fiberoptic illumination	281
Plaster saws, electric	321, 322	Retractors, abdominal	298-307
Plaster shears	320	Retractors, delicate	250
Plaster, knives	318	Retractors, hand surgery	285
Plaster, saws	318	Retractors, self-retaining	283, 284, 287-297
Plaster, trephines	318	Retractors, spinal	250
Plaster-of-Paris shears	134	REVERDIN , abdominal spatulas	308

	Page		Page
REVERDIN , needles	214	SCHMID , special needles	345
REYNOLDS , scissors	112	SCHMIEDEN , ligature needles	217
REZAK-HEANEY , hysterectomy forceps	44	SCHMIEDEN-PAYR , ligature conductors	221
RIBBON , eye scissors	127	SCHMIEDEN-TAYLOR , scissors	116
RICARD , abdominal retractors	306	SCHNIDT-SAWTELL , tonsil hemostatic forceps	27
RICHARDSON (KELLY) , retractors	264	SCHOEMAKER , goitre enucleation scissors	119
RICHARDSON-EASTMAN , retractors	264	SCHOEMAKER-LOTH , ligature scissors	128
RICHTER , operating scissors	104	SCHUHKNIGHT , selfretaining retractors	289
RICHTER-HEATH , suture forceps	224	SCHUKNECHT , wire cutting scissors	130
RIGHBY , selfretaining retractors	295	SCHULZE-BERGMANN , rectal specula	535
RIRAP , stethoscopes	378	SCHUMACHER , umbilical scissors	121
RISCOPE S , ophthalmoscope	381	SCHWECKENDICK-GOOD , tonsil scissors	119
RISCOPE S , oto-/ophthalmoscope	380	Scissors	102-162
ROBERTS , artery forceps	30	Scissors, abdominal	106
ROBIN-MASSE , abdominal retractors	306	Scissors, bandage	132-134
ROCHESTER-CARMALT , artery forceps	27	Scissors, capsulotomy	140
ROCHESTER-PEAN , artery forceps	18, 19	Scissors, cartilage	118
ROEDER , towel forceps	52	Scissors, clotting	132, 133
ROETTGEN-RUSKIN , bone rongeurs	473	Scissors, corneal	141-143
ROGGE , sterilizing forceps	564	Scissors, coronary	115
ROLLET , delicate hooks	246	Scissors, crown	130, 131
ROSCHKE , anoscopes	537	Scissors, cuticle	135
ROSSEGGER-KLIMA , biopsy needles	343	Scissors, dissecting	108-112
ROTTER , ligature needles	219	Scissors, enterotomy	118
ROUX , retractors	277	Scissors, episiotomy	121
ROWE , reposition forceps	487	Scissors, eye	125-127, 138-143
RUDD , haemorrhoidal ligators	554	Scissors, fine	122-124
RUMEL , dissecting and ligature forceps	31	Scissors, goitre enucleation	119
RUSKIN , bone rongeurs	471, 475	Scissors, gum	136, 137
RUSKIN-LISTON , bone cutting forceps	478	Scissors, gynecological	105-107
RUSKIN-MINI , bone rongeurs	471	Scissors, incision	104
RUSS. MODEL , grasping forceps	68	Scissors, iridectomy	138
RUSS.-MAYO , grasping forceps	66	Scissors, iris	125, 138
RYDER/FRENCH EYE , needle holders tungsten TUC	193	Scissors, ligature	128, 129
RYDER-LANGENBECK , needle holders tungsten TUC	202	Scissors, lobectomy	118
RYDER-MATHIEU VASCULAR , needle holders tungsten TUC	200	Scissors, micro	143-149
RYDER-MATHIEU , needle holders tungsten TUC	200	Scissors, micro adventitia	145, 147
RYDER-MICRO , needle holders tungsten TUC	193	Scissors, micro dissection	145, 147
		Scissors, micro nerve	147
S		Scissors, nail	135
Safety pins	564	Scissors, nail splitting	135
SALAH , biopsy needles	343	Scissors, nasal	119, 120
SALENIUS , meniscotomy knives	467	Scissors, nerve dissecting	111
SAMII , grasping forceps	70	Scissors, neuro surgery	115-117
SANVENERO , scissors	112	Scissors, operating	102-105, 122
SAROT , bronchus forceps	30	Scissors, plaster-of-Paris	134
SAROT , needle holders	183	Scissors, secondary cataract	139
SAROT , needle holders tungsten TUC	197	Scissors, strabismus	126
SATINSKY , scissors	117	Scissors, super-cut SC	101
SATTERLEE , amputating saws	384	Scissors, tenotomy	126, 140
SATTLER , muscular forceps	87	Scissors, tonsil	119
SAUERBRUCH , bone rongeurs	474	Scissors, tungsten TUC	152-162
SAUERBRUCH , retractors	260, 274	Scissors, umbilical	121
Saw blades for electric plaster saw	323	Scissors, vascular surgery	113-117
Saws	384, 482-485	Scissors, wire cutting	130
Saws, plaster	318	Screw drivers	491
SAWTELL-SCHNIDT , tonsil hemostatic forceps	27	SCUDDER , Non-traumatic stomach and intestinal forceps	526
SAWYER , rectal specula	534	SCUDDER , stomach and intestinal clamp forceps	523, 526
Scalp flap forceps	12, 26	SEBILEAU , elevators	447
SCALP-CONTOUR , selfretaining retractors	294	Secondary cataract scissors	139
Scalpel blades	167, 168	SEDILLOT , raspatories	445
Scalpel, handles	165-167	SEGOND , hysterectomy forceps	45
Scalpels	165-177	SEGOND-LANDAU , hysterectomy forceps	45
SCHAEDEL , towel forceps	51	Seizing forceps	12, 13
SCHANZ , wires	503	Self-retaining retractors	283, 284, 287-297
SCHUDE , bone curettes	435	SELLORS-CRAFOORD , auricle forceps	29
SCHINDLER , peritoneal clamp forceps	50	SEMB , bone cutting forceps	480
SCHINK , dermatomes	176	SEMB , bone holding forceps	456
		SEMB , bone rongeurs	472

	Page		Page
SEMB , raspatories	446	Sterilizing forceps	564
SEMKEN , dissecting forceps tungsten TUC	92	STERNUM , wire forceps TUC	403
SEMKEN , dressing and tissue forceps	60, 61	STERNUM , wire twisting forceps tungsten TUC	203
SEMM , abdominal retractors	303	Stethoscopes	377, 378
SENN-GREEN , delicate retractors	247	STEVENS , iris forceps	80
SENNING (SWED. MODEL) , needle holders	183	STEVENS , micro needle holders	212
SENNING (SWED. PATTERN) , needle holders tungsten TUC	194	STEVENS , scissors tungsten TUC	161
SENN-MILLER , delicate retractors	250	STEVENS , tenotomy scissors	126
SENN-MILLER-BABY , delicate retractors	250	STIEGLITZ , splinter forceps	75
Sensibility instruments	376	STILLE , bone rongeurs	472
Setting forceps	11	STILLE , chisels	421
SEUTIN , bandage scissors	134	STILLE , dressing and tissue forceps	65
Shears, plaster-of-Paris	134	STILLE , hand drills	386
SHORTBENT , ligature scissors	129	STILLE , kidney pedicle clamp forceps	38
SIEBOLD , scissors	107	STILLE , Mini plaster shear	320
SIMON , fistula knives	174	STILLE , osteotomes	421
SIMON , retractors	262	STILLE-BARRAYA , tissue forceps	65
SIMS , rectal specula	534	STILLE-DOYEN , retractors	266
SIMS , scissors	107	STILLE-LISTON , bone cutting forceps	479
SIMS , scissors tungsten TUC	155	STILLE-LUER , bone rongeurs	473
SIMS-MAIER , polypus forceps	239	STILLE-MAYO , scissors	105
SINGLEY-TUTTLE , grasping forceps	66	STILLE-MAYO , scissors tungsten TUC	154
SINUSCOPY , trocars	327	STILLE-RUSKIN , bone rongeurs	472
SMILLIE , knee retractors	466	STILLE-SHERMAN , hand drills	385
SMILLIE , meniscotomy knives	467	Stomach and intestinal clamp forceps	520-523
SMITH (MOD. USA) , bandage scissors	133	Stomach and intestinal crushing clamps	530
SMITH , wire cutting scissors	130	Stomach clamp forceps	531
SMITH-BUIE , rectal specula	536	Stopcocks	349
SMITH-FERRIS , tissue forceps	65	Strabismus scissors	126
SMITH-HEYWOOD , sponge holding forceps	236	STRATTE , needle holders	185
SMITH-PETERSEN , chisels	419	STRATTE , needle holders tungsten TUC	197
SMITH-PETERSEN , osteotomes	419	STRAUSS , rectoscope	548
SMITH-PETERSON , bone rongeurs	475	Strippers, vascular	315
SMITH-POTTS , dissecting forceps tungsten TUC	92	STRULLY , scissors	115
SMITH-POTTS , dressing and tissue forceps	63	Suction tubes	331-337, 503
SMITH-POTTS , micro needle holders	212	SULLIVAN (BROPHY) , fine scissors	123
SMITH-POTTS , micro needle holders tungsten TUC	205	SULLIVAN , gum scissors	137
SMITH-POTTS , scissors	113, 115, 118	Super Cut Scissors	101
SMITH-POTTS , scissors tungsten TUC	157	Suture	180-225
SNELLEN , entropium forceps	88	Suture forceps	224, 225
SNITMAN , self-retaining retractors	284	Suture tweezers	97
Soft tissue retractors	255, 256	Suture tying forceps with platform	71, 72
Solutions bowls	562	Suture, clips	225
Spatulas abdominal	308	Suture, forceps	85, 86
Special needles	345	SWED. MODEL (SENNING) , needle holders	183
Special needles/puncture	327-349	SYME , ligature needles	216
SPENCER , ligature scissors	128	Syringes	348
SPENCER-DELICATE , ligature scissors	128		
SPENCER-WELLS , artery forceps	14	T	
Sphincteroscopes	537-541	Tampers	451
Spinal retractors	250	Tampon forceps	78
Splinter forceps	73-75	TAYLOR , bone levers	398
Sponge holding forceps	228-239	TAYLOR , dressing and tissue forceps	61
SPRATT , bone curettes	435	TAYLOR , percussion hammers	369
Spray gun	590, 591	TAYLOR , spinal retractors	250
ST. MARKS , retractors	275	TAYLOR-CUSHING , dissecting forceps tungsten TUC	93
ST. MARTIN , suture forceps	85	TAYLOR-SCHMIEDEN , scissors	116
STACKE , probes	310	Tendon seizing instruments	464
STADLER-BRAUN , episiotomy scissors	121	Tendon stripper	465
STANDARD , dressing forceps	57	Tenotomy scissors	126, 140
STANDARD , gum scissors	137	TERRIER , artery forceps	14
STANDARD , operating scissors	102	TERSON , iris forceps	83
STANDARD , scissors tungsten TUC	152, 153	THIERSCH , transplantation knives	175
STANDARD , tissue forceps	57	THIESS , mallets	430
STANDARD , trocars	327	THOMS-ALLIS , tissue seizing forceps	518
STEINBACH , mallets	432	THOREK , scissors	111
STEINMANN , pins	399, 497, 498	THORPE , caliper	372
STEINMANN , tendon seizing instruments	464	Tissue forceps	57-65, 67, 68
STELLBRINK , bone rongeurs	468		

	Page		Page
Tissue seizing forceps	9	VIRCHOW , brain knives	173
Tissue seizing forceps	517-519	WISE , suture tying forceps with platform	71
TOENNIS , dissecting and ligature forceps	36	VOLKMANN , bone curettes	434, 440
TOENNIS , needle holders	188	VOLKMANN , retractors	251, 252
TOENNIS , needle holders tungsten TUC	201		
TOENNIS , scissors	116	W	
TOENNIS-ADSON , scissors	116		
TOENNIS-ADSON-DELICATE , scissors tungsten TUC	161	WACHENFELDT , suture forceps	224
TOHOKU-JAPAN , towel forceps	52	WAGNER , fine scissors	122
Tonsil hemostatic forceps	27	WALB , post mortem knives	173
Tonsil scissors	119	WALDMANN , episiotomy scissors	121
Towel forceps	51, 52	WALTER , retractor	250
TOWNLEY , caliper	372	WALTER-CARMALT , splinter forceps	73
Transplantation knives	175	WALTON , fine scissors	124
TRAVERS , selfretaining retractors	288	WALTON , finger ring saws	482
Tray	561	WALTON , polypus forceps	239
TRELAT , ligature needles	218	WALTON , selfretaining retractors	297
Trephines, plaster	318	WALTON-LISTON , bone cutting forceps	478
TROCAR , biopsy needles	344	WALTON-YANKAUER , suction tubes	331
Trocars	327-330	WANGENSTEEN , dissecting forceps tungsten TUC	94
TROELTSCH (WILDE) , ear dressing forceps	77	WANGENSTEEN , dressing forceps	65
TROEMNER , percussion hammers	370	WANGENSTEEN , needle holders	185
TROUTMAN (CORNEAL) , iris forceps	82	WANGENSTEEN , needle holders tungsten TUC	197
TROUTMAN , corneal section scissors	141	WANGENSTEEN-DELICATE , delicate needle holders	185
TROUTMAN , micro needle holders	207	WARTENBERG , sensibility instruments	376
TROUTMAN-BARRAQUER , micro needle holders	206	WATSON , dermatomes	176
TROUTMAN-CHRIS , blade breakers	177	WAUGH , grasping forceps	67
Tubing clamps	53	WEBSTER , needle holders	181
TÜBINGEN MODELL , retractors	262	WEBSTER , needle holders tungsten TUC	195
TÜBINGER MODELL , selfretaining retractors	296	WECKER , iris scissors	138
TUDOR-EDWARDS , bone cutting forceps	479	WEITLANER , selfretaining retractors	287
TUFFIER , abdominal spatulas	308	WEITLANER-BABY , selfretaining retractors	287
TUFFIER , blood vessel clamps	12	WELLS-SPENCER , artery forceps	14
TUFFIER , retractors	267	WERTHEIM , hysterectomy forceps	41, 42
Tungsten Carbide Tips with pyramidal profile	190, 191	WERTHEIM , needle holders	185
TUOHY , biopsy needles	344	WERTHEIM , needle holders tungsten TUC	198
TURNBULL , nail forceps	568	WERTHEIM , scissors	106
TUTTLE-SINGLEY , grasping forceps	66	WERTHEIM-CULLEN , hysterectomy forceps	44
		WESTCOTT , micro scissors	143
U		WESTCOTT , tenotomy scissors	140
		WESTERMARK , dressing forceps	232
UCKERMANN , cotton applicators	312	WIGMORE , plaster saws	318
ULRICH , bone holding forceps	462	WIKSTROEM , dissecting and ligature forceps	41
ULRICH , polypus forceps	229	WILDBERG , clips	496
Umbilical scissors	121	WILDE (TROELTSCH) , ear dressing forceps	77
Universal tray	561	WILLET-MARTEL , scalp flap forceps	12
UNIVERSAL , bandage scissors	132	WILLIAMS , tissue seizing forceps	518
UNIVERSAL , bone rongeurs	468	WILLIGER , bone curettes	440
UNIVERSAL , hand drills	389	WILLIGER , elevators	447
UNIVERSAL , scissors tungsten TUC	162	WILLIGER , mallets	428
UNIVERSAL , trocars	327	WILLIGER , raspatories	444
UNIVERSAL , wire cutting scissors	130	WILMER , eye scissors	126
		Wire cutting scissors	130
V		Wire forceps	401-403, 405, 406
		Wire twisting instruments	407
VACUNOPA , vacuum cleaner	324	Wires	499-502
VAN BUREN , bone holding forceps	452	WISCONSIN (FOREGGER) FIBRE OPTIC , laryngoscopes	358
VANNAS MOD. TÜBINGEN , secondary cataract scissors	139	WISCONSIN (FOREGGER) , laryngoscopes	354
VANNAS , secondary cataract scissors	139	WOLFF , Plaster cast bending forceps	320
Varicose vein probe set	312	WULLSTEIN MICRO , suction tubes	335
Vascular surgery scissors	113	WULLSTEIN , selfretaining retractors	289
Vascular surgery scissors	113-117	Y	
Vascular, dilators	314, 314		
Vascular, strippers	315	YANCOSKIE , retractors	280
VERBRUGGE , bone holding forceps	459	YANKAUER , suction tubes	331
VERNET-GIL , delicate retractors	249	YANKAUER-WALTON , suction tubes	331
VERNIER , caliper	372, 373	YEOMAN , rectal biopsy forceps	551
VERRES , special needles	345	YOUNG-HRYNTSCHAK , boomerang needle holders	189
Vessel dilators	72		

Z

ZAUFAL-JANSEN , bone rongeurs	471
ZENKER , dissecting and ligature forceps	32
ZENKER , retractors	272
ZIEGLER , cilia forceps	76
ZWEIFEL , needle holders	187
ZWEIFEL , needle holders tungsten TUC	202

Índice alfabética

	Página		Página
A		B	
Accesorios para clavos intramedulares con ganchos	490	BABCOCK , pinzas para coger intestinos	9
Accesorios para power drills	392	BABCOCK , pinzas para coger intestinos	519
Accu power drill	391	BABINSKY , martillos de percusión	369
Acumulador / cargador para power drills	393	BABY-KOCHER , pinzas-clamps estomacales y intestinales Atrauma	526
ADAMS-MAYO , separadores autoestaticos	296	BABY/LIGHTWEIGHT-DUPLEX , estetoscopios	378
ADISON , pinza de protección	390	BABY-ADSON , pinzas hemostáticas	25
ADLERKREUTZ , pinzas de disección con dientes	65	BABY-BALFOUR , separadores abdominales	299
ADSON , elevadores	449	BABY-CRILE-WOOD , porta-agujas	182
ADSON , pinzas de disección	59, 60	BABY-CRILE-WOOD , porta-agujas tungsteno TUC	196
ADSON , pinzas de disección con dientes	59, 60	BABY-DOYEN , pinzas-clamps estomacales y intestinales	520
ADSON , pinzas de disección tungsteno TUC	93	BABY-KOCHER , pinzas-clamps estomacales y intestinales	521, 526
ADSON , pinzas hemostáticas	25	BABY-LEXER , tijeras para preparaciones	111
ADSON , porta-agujas	183	BABY-METZENBAUM , tijeras para preparaciones	108
ADSON , separadores autoestaticos	290, 291	BABY-MIKULICZ , pinzas-clamps para peritoneo	49
ADSON , tubos de aspiración	335	BABY-MIXTER , pinzas para preparaciones y ligaduras	33
ADSON-ANDERSON , separadores autoestaticos	290	BABY-OVERHOLT , pinzas para preparaciones y ligaduras	23
ADSON-BABY , pinzas hemostáticas	25	BABY-POOLE , tubos de aspiración	332
ADSON-BABY , separadores autoestaticos	292	BABY-SENN-MILLER , separadores finas	250
ADSON-BECKMANN , separadores autoestaticos	293	BABY-WEITLANER , separadores autoestaticos	287
ADSON-BROWN , pinzas de disección con dientes	60	BACKHAUS , pinzas de campo	52
ADSON-MICRO , pinzas de disección	59	BACKHAUS , pinzas para compresas	52
ADSON-MICRO , pinzas de disección con dientes	59	BACON , pinzas-gubias	470
ADSON-TOENNIS , tijeras para cirugía vasculares	116	BAINBRIDGE , pinzas hemostáticas	27
ADSON-TOENNIS-DELICATE , tijeras tungsteno TUC	161	BAINBRIDGE , pinzas-clamps estomacales y intestinales Atrauma	524
ADVENTITIA , micro-tijeras	145, 147	BALFOUR US-TYPE , separadores abdominales	299
Agrafes	225	BALFOUR , separadores abdominales	299, 300
Agujas	499-502	BALFOUR-BABY , separadores abdominales	299
Agujas de guía	346	BALL & SOCKET , pinzas de campo	52
Agujas de REVERDIN	214	BALL & SOCKET , pinzas para compresas	52
Agujas especiales	345	BALLANTINE-HEANEY , pinzas-clamps para histerectomía	43
Agujas especiales/punción	327-349	BALLENGER-FOERSTER , pinzas para esponjas	237
Agujas para biopsia	343, 344	Bandeja	561
Agujas para ligaduras	215-219	BARRAQUER , micro-porta-agujas	206
Air power drill	391	BARRAQUER , pinzas depilatorias	76
ALAN PARKS , anoscopios	537	BARRAQUER , pinzas para la cámara anterior	85
ALDERDYCE , elevadores	448	BARRAQUER , pinzas-tijeras para iridectomia	138
ALEXANDER , cinceles	418	BARRAQUER-KATZIN (COLIBRI) , pinzas para iris	82
ALEXANDER , raspadores	446	BARRAQUER-KATZIN , pinzas-tijeras para córnea	142
Alicates planos	404	BARRAQUER-TROUTMAN , micro-porta-agujas	206
ALLIS , pinzas para coger tejidos	9	BARRAYA-STILLE , pinzas de disección con dientes	65
ALLIS , pinzas para coger tejidos y intestinos	517	BAUMGARTNER , porta-agujas	184
ALLIS-ADAIR , pinzas para coger tejidos y intestinos	517	BECK-LUETHY , porta-agujas tungsteno TUC	202
ALLIS-BABY , pinzas para coger tejidos y intestinos	517	BECKMANN , separadores autoestaticos	292
ALM , separadores autoestaticos	283	BECKMANN-ADSON , separadores autoestaticos	293
ALY , instrumentos sensibilidad	376	BECKMANN-EATON , separadores autoestaticos	293
ANDERSON-ADSON , separadores autoestaticos	290	BEEBEE , tijeras para coronas	130, 131
ANDREWS-PYNCHON , tubos de aspiración	331	BEER , pinzas depilatorias	76
Anestesia	353-363	BEESON , separadores de enyesados	319
Anoscopios	537-543	BENGOLEA , pinzas hemostáticas	28
ANVIL , pinzas corta-unas	571	BENSAUDE , anoscopios	540
ARLT-FISCHER , pinzas para iris	80	BERENS , pinzas musculares	88
ARRUGA , micro-porta-agujas	212	BERGMANN , martillos	427
ARRUGA , pinzas capsulares	83	BERGMANN , sierras para vendajes enyesados	318
ARRUGA , porta-agujas	180	BERGMANN , tijeras para vendajes	132
ARRUGA , porta-agujas tungsteno TUC	201	BERKE , pinzas de chalazión	89
ARRUGA-KALT , micro-porta-agujas	212	BERLINER , martillos de percusión	370
Artroscopio	408-415	BERNHARD , pinzas de campo	51
AUSTIN , pinzas de ligadura	71	BERNHARD , pinzas para compresas	51
AUSTRALIA , separadores para dedos	283	BEYER , pinzas-gubias	471
AUSTRALIA , separadores para la cirugía de la mano	285	BILLROTH , separadores	252
AYER , pinzas de chalazión	88	BIRCHER , bisturios para meniscos	467
		BIRCHER-GANSKE , pinzas para huesos	453
		BIRKETT , pinzas para preparaciones y ligaduras	41

BISHOP-HARMAN , pinzas para iris	82	CAPLAN , tijeras nasales	119
Bisturías	165-177	CARDINALE , tijeras para ginecología	107
Bisturías para abscesos	174	CARDINALE , tijeras tungsteno TUC	155
Bisturías para fistulas	174	CARDIOPHON , estetoscopios	378
Bisturías para meniscos	467	CARMALT-ROCHESTER , pinzas hemostáticas	27
Bisturías para operaciones	169-171	CARMALT-WALTER , pinzas para espinas	73
BLASCOVICS , pinzas musculares	87	CAROLL , goniómetros	373
BLOND , anoscopios	542, 543	CAROLL , instrumentos para coger tendones	464
BLOUNT , elevadores para huesos	398	CARREL , pinzas hemostáticas	14
BLOUNT , separadores para rodilla	466	CARROLL , porta-agujas	182
BLUEPOWER , cortador eléctrico para vendajes duros	322	CARROLL , porta-agujas tungsteno TUC	194
BLUMENTHAL , pinzas-gubias	469	CARTILAGE-MARTIN , tijeras	118
Bocas de carburo de tungsteno con perfil	190, 191	CASTROVIEJO , círculo	375
BÖHLER , estribos para extensión	399	CASTROVIEJO , micro-porta-agujas	210, 213
BÖHLER , pinzas-gubias	471	CASTROVIEJO , micro-porta-agujas tungsteno TUC	204, 205
BOLEY , calibrador	373	CASTROVIEJO , pinzas capsulares	83
Bombillos de laringoscopio	356	CASTROVIEJO , pinzas de fijación	84
Bombillos de laringoscopio Fibre Optic	360	CASTROVIEJO , pinzas para romper hojas	177
BONACCOLTO , pinzas para sutura	85	CASTROVIEJO , pinzas para sutura	85
BONNEY , pinzas de disección tungsteno TUC	94	CASTROVIEJO , pinzas-tijeras para córnea	141
BONNEY , pinzas para coger	68	CASTROVIEJO , pinzas-tijeras para iridectomia	138
Boomerang porta-agujas	189	CASTROVIEJO-EPKER , círculo	375
BÖTTCHER , tijeras para amígdalas	119	CASTROVIEJO-KALT , micro-porta-agujas	212
BOYNTON , porta-agujas	180	CATLIN , cuchillas para amputación	172
BOYNTON , porta-agujas tungsteno TUC	201	Cepillos de limpieza	583-589
BOYS-ALLIS , pinzas para coger tejidos y intestinos	518	CHADWICK , tijeras oculares	126
BOZEMANN , instrumentas ligaduras	223	CHAPUT , pinzas para coger	12
BOZEMANN , pinzas para tapones	233	CHARRIERE , sierras para amputación	384
BOZEMANN , porta-agujas	182	CHEATLE , pinzas para esterilización	564
BOZEMANN , porta-agujas tungsteno TUC	197	CHERON , pinzas para tapones	234
BOZEMANN-DOUGLAS , pinzas para tapones	233	CHILDE , pinzas para agrafes	225
BRAND , instrumentos para coger tendones	464	CHRIS-TROUTMAN , pinzas para romper hojas	177
BRAUN-STADLER , tijeras para episiotomía	121	CHURCH , tijeras para cirugía vasculares	117
BRIDGE , pinzas para preparaciones y ligaduras	34	Cinceles	417-426
BRINKHORST , pinzas capsulares	83	Cizallas para cortar alambre	130
Broca para tornillos para huesos	513	Cizallas para escayola	320
BRODIE , sondas	311	Cizallas para vendajes enyesados	134
BROPHY (SULLIVAN) , tijeras finas	123	Clamp sujetador de huesos	394
BROPHY , pinzas de disección	63	Clamps bulldog	10, 11
BROPHY , pinzas de disección con dientes	63	Clamps para vasos	12
BROWN , pinzas de disección con dientes	64	CLAR 55 , lámparas frontales	368
BROWN , porta-agujas	183	CLAR STANDARD , lámparas frontales	368
BROWN-ADSON , pinzas de disección con dientes	60	CLASSON , tijeras para cirugía vasculares	117
BROWNE-DENIS , separadores abdominales	301	CLAUS , agujas para ligaduras	218
BRUNNER , agujas para ligaduras	216, 217	CLAUS-EICKEN , agujas para ligaduras	219
BRUNNER , pinzas-clamps estomacales y intestinales	520	Clavos	492-498
BRUNNER , separadores	263	Clavos intramedulares	495
BRUNNER , sondas conductoras	220	CLEVELAND , pinzas cortantes para huesos	478
BRUNNER-FERROZELL , sondas conductoras	222	CLEVELAND , pinzas-gubias	468
BRUNS , cizallas para vendajes enyesados	134	CLEVELAND-GARDNER , pinzas cortantes para huesos	477
BRUNS , cucharillas cortantes	434, 437	CLOWARD HIBBS SPRATT , cucharillas cortantes	437
BRYANT , pinzas para esponjas	228	COAKLEY , trocares	330
BUCK , martillos de percusión	369	COBB , cinceles	424
BUCK , tijeras para ligaduras	129	COBB , cucharillas cortantes	439
BULEAU , trocares	328	COBB , elevadores	449
BUNNELL , perforadores de mano	388	COGSWELL , tubos de aspiración	336
BUNNELL , separadores para tendones	465	COLIBRI (BARRAQUER-KATZIN) , pinzas para iris	82
BUSCH , tijeras umbilicales	121	COLLEGE-LONDON , pinzas para algodón y curaciones	95
BYRD , tubos de aspiración	332	COLLER , pinzas hemostáticas	17
C		COLLIER , porta-agujas	180
Cadres de esterilización	564	COLLIN , bisturías para operaciones	170
CAIRNS , pinzas hemostáticas	22	COLLIN , cuchillos para amputación	172
Cajas para instrumentos	562	COLLIN , dinamómetro	374
Calibrador	372, 373	COLLIN , mangos de bisturías	166
CAMPBELL , trocares	328	COLLIN , martillos	429
CANNY RYALL , separadores	279	COLLIN , pinzas para agrafes	224
Cánulas de liposucción y infiltración	339, 341, 342	COLLIN , pinzas para coger	13
		COLLIN , pinzas para tapones	234
		COLLIN , separadores abdominales	304, 305

	Página		Página
COLLIN-BABY , separadores abdominales	304	DE BAKEY , pinzas atrauma	91
COLLIN-DUVAL , pinzas para coger	66	DE BAKEY , pinzas de disección tungsteno TUC	94
COLLIN-HARTMANN , separadores	277	DE BAKEY , porta-agujas tungsteno TUC	192
CONE , separadores autoestáticos	292	DE BAKEY , tijeras para cirugía vasculares	113, 116
Conector	363	DE BAKEY , tijeras tungsteno TUC	157
CONVERSE , porta-agujas tungsteno TUC	195	DE BAKEY , tubos de aspiración	331
CONVERSE-DERF , porta-agujas	180	DE LA ROZA , agujas para ligaduras	217
COOLEY , dilatadores vasculares	313	DE MARTEL-POTTS , tijeras para cirugía vasculares	116
COOLEY , tubos de aspiración	333	DE MARTEL-WOLFSON , pinzas-clamps intestinales	532, 533
COOPER , agujas para ligaduras	216	DE MARTEL-WOLFSON , pinzas-clamps para anastomosis	532, 533
Copas graduadas	556, 559	DEAN , tijeras para encias	136
CORNEAL (TROUTMAN) , pinzas para iris	82	DEAN , tijeras tungsteno TUC	162
Cortador eléctrico para vendajes duros	321, 322	DEAN-DELICATE , tijeras para encias	136
Cortador eléctrico para vendajes duros OSCInopa	321	DEAVER , separadores	269-271
CORWIN , pinzas para torcer hilos con hilos TUC	403	DEAVER , tijeras para cirugía	104
CORWIN , pinzas para torcer hilos tungsteno TUC	203	DEJERINE , martillos de percusión	370
CORYLLOS , separadores	274	DEMEL , tensores cierra-hilos	407
COTTLE KAZANJIAN , pinzas cortantes para huesos	477	DENIS-BROWNE , separadores abdominales	301
COTTLE , martillos	428	DERF , porta-agujas	180
COTTLE , pinzas nasales	77	DERF , porta-agujas tungsteno TUC	195
COTTLE , tijeras nasales	120	DERF-CONVERSE , porta-agujas	180
COUPLAND , tubos de aspiración	332	Dermatomo	176
COUPLAND , tubos de aspiración	337	DESCHAMPS , agujas para ligaduras	215
CRAFOORD , pinzas-clamps bronquiales	30	DESJARDINS , pinzas-clamps para conducto biliar	40
CRAFOORD , tijeras	118	DESMARRES , ganchos	248
CRAFOORD-SELLORS , pinzas para aurícula	29	DESMARRES , pinzas de chalazión	88
CRANE-KAPLAN , pinzas para bolsas	98	Desobliteradores de vasos	315
CREGO , elevadores para huesos	398	Destornilladores	491
CRILE , pinzas hemostáticas	17	Diagnostico	367-382
CRILE , porta-agujas	187	DICK , pinzas para anastomosis	528
CRILE-MURRAY , porta-agujas	182	DIEFFENBACH , bisturíes para abscesos	174
CRILE-RANKIN , pinzas hemostáticas	17	DIEFFENBACH , bisturíes para operaciones	170, 171
CRILE-WOOD , porta-agujas	182	DIEFFENBACH , clamps bulldog	11
CRILE-WOOD , porta-agujas tungsteno TUC	196	DIETHRICH , micro-porta-agujas tungsteno TUC	205
CRILE-WOOD-BABY , porta-agujas	182	DIETHRICH-HEGEMANN , tijeras para cirugía vasculares	114
CRILE-WOOD-BABY , porta-agujas tungsteno TUC	196	Dilatadores para vasos	72
Cubeta universal	561	Dilatadores vasculares	313, 314
Cubetas	559, 561, 562	Dinamómetros	374
Cubetas para soluciones	562	DINGMANN , pinzas para cartilago	453
Cubetas redonda	559	DIPLOMAT , manómetro para la presión de la sangre	379
Cucharillas cortantes	434-441	DISSECTION , micro-tijeras	145, 147
Cuchillos para amputación	172	DIXON-LOVELACE , pinzas hemostáticas	26
Cuchillos para cerebro	173	DOUGLAS , pinzas depilatorias	76
Cuchillos para órganos	173	DOUGLAS , trocares	330
Cuchillos para transplantación	175	DOUGLAS-BOZEMANN , pinzas para tapones	233
Cuchillos para vendajes enyesados	318	DOYEN , martillos	428
CULLEN-WERTHEIM , pinzas-clamps para histerectomía	44	DOYEN , pinzas de campo	51
Cunas	559	DOYEN , pinzas para compresas	51
Curetas	434-441	DOYEN , pinzas-clamps estomacales y intestinales	520, 524
CUSHING , ganchos	244, 248	DOYEN , pinzas-clamps estomacales y intestinales Atrauma	524
CUSHING , perforadores de mano	387	DOYEN , porta-agujas	180
CUSHING , pinzas de disección	62	DOYEN , raspadores	445
CUSHING , pinzas de disección con dientes	62	DOYEN , separadores	267
CUSHING , pinzas de disección tungsteno TUC	93	DOYEN , separadores abdominales	302
CUSHING , separadores espinales	250	DOYEN , sondas	310
CUSHING-TAYLOR , pinzas de disección tungsteno TUC	93	DOYEN , tijeras	106
CZERNY , espéculos rectales	534	DOYEN-STILLE , separadores	266
CZERNY , separadores	279	DUBOIS , tijeras para ginecología	107
D		DUEHRSSSEN , pinzas de disección	64
DAHMEN , cinceles	425	DUEHRSSSEN , pinzas de disección con dientes	64
DAHMEN , gubias	425	DUNHILL , pinzas hemostáticas	22
DANDY , pinzas hemostáticas para pericráneo	26	DUPLAY , pinzas para pólipos	236
DANDY , tijeras para cirugía vasculares	115	DUPLEX-LIGHTWEIGHT/BABY , estetoscopios	378
DARLING , separadores autoestáticos	295	DURANTE , pinzas para coger	68
DAVIDSON , separadores	276	DUVAL , pinzas para coger	68
DAVIS-RAGNELL , separadores finas	250	DUVAL , pinzas para coger intestinos	519
DE BAKEY , dilatadores vasculares	314	DUVAL-COLLIN , pinzas para coger	66
		DYNAMOMETER III	374

E

EASTMAN-RICHARDSON , separadores	264
EATON-BECKMANN , separadores autoestáticos	293
ECHLIN , pinzas-gubias	474
ECONOM , juegos para diagnóstico	380
EICKEN , trocares	330
EICKEN-CLAUS , agujas para ligaduras	219
EICKEN-KILLIAN , tubos de aspiración	335
EISELSBERG , tijeras para ligaduras	128
Elevadores	447-449, 481
Elevadores para huesos	395-398
ELSCHNIG , pinzas de fijación	84
ENGEL , sierras para vendajes enyesados	318
ENGL. MODELL , pinzas de campo	51
ENGL. MODELL , pinzas para compresas	51
ERHARDT , pinzas entropión	88
Escofinas	451
Esfinteroscopios	537-541
ESMARCH , cuchillos para vendajes enyesados	318
ESMARCH , tijeras para vendajes	134
Espátulas abdominales	308
Espéculos rectales	534-536
Espejos frontales	367
Estetoscopios	377, 378
Estrijos para extensión	399, 400
Estuches para esterilizar agujas	560
EUFRATE PASQUE , porta-agujas TUC	193
EWALD , pinzas de disección	60
EWALD , pinzas de disección con dientes	60
EXCENTRIC-LISTER , tijeras para vendajes	133

F

FALK , agujas para ligaduras	219
FARABEUF , pinzas para huesos	458
FARABEUF , raspadores	443
FARABEUF , separadores	278
FARABEUF-LAMBOTTE , pinzas para huesos	458
FARRELL , porta-algodones	311
FAULKNER , pinzas para tener cristalino	90
FAURE , pinzas-clamps para histerectomía	45
FAURE , pinzas-clamps para peritoneo	50
FAVALORO , tijeras para cirugía vasculares	115
FEHLAND , pinzas-clamps estomacales y intestinales	527
FEILCHENFELD , pinzas para espinas	73
FEIN , porta-algodones	312
FERGUSSON , pinzas para huesos	455
FERGUSSON , pinzas-clamps de presión progresiva	47
FERGUSSON , tijeras para cirugía	104
FERGUSSON , tubos de aspiración	335
FERREIRA , separadores con iluminación de luz fría	280
FERRIS-SMITH , pinzas de disección con dientes	65
FERROZELL , sondas conductoras	222
FERROZELL-BRUNNER , sondas conductoras	222
FERROZELL-KIRSCHNER , sondas conductoras	222
FINOCCHIETTO , pinzas-clamps para pedúnculos renales	37
FINOCCHIETTO , porta-agujas	185
FINOCCHIETTO , porta-agujas tungsteno TUC	197
FINOCCHIETTO , tijeras	118
FINSEN , separadores autoestáticos	283
FISCHER-ARLT , pinzas para iris	80
FLAGG , pinzas para algodón y curaciones	96
FLETCHER , pinzas para esponjas	232
FOERSTER , pinzas para iris	81
FOERSTER-BALLENGER , pinzas para esponjas	237
FOMON , tijeras nasales	119
FOMON , tijeras para preparaciones	111
FOREGGER (WISCONSIN) , Fibre Optic laringoscopios	358

FOREGGER (WISCONSIN) , laringoscopios	354
FOX , cucharillas cortantes	436
FOX-GOLDMAN (SPEZIAL) , tijeras para encías	136
FOX-GOLDMAN , tijeras para encías	136
FOX-GOLDMAN , tijeras tungsteno TUC	161
FRANKENFELDT , pinzas para coger	316
FRANZ , separadores abdominales	302
FRAZIER , ganchos	242
FRAZIER , tubos de aspiración	335
FREER , elevadores	448
FRENCH-EYE/Ryder , porta-agujas tungsteno TUC	193
FRIEDMAN , pinzas-gubias	468
FRIEDRICH , instrumentas ligaduras	223
FRITSCH , separadores	266
FRYKHOLM , pinzas-gubias	474
FUCHS-GILL , pinzas para iris	83
FULTON , tijeras para cirugía vasculares	117

G

Ganchos	242-250
GARRETT , dilatadores vasculares	313
GEISSENDOERFER-OVERHOLT , pinzas para preparaciones y ligaduras	23
GELPI , separadores autoestáticos	294
GEMINI , pinzas para preparaciones y ligaduras	35
GERALD , pinzas de disección	62
GERALD , pinzas de disección con dientes	62
GERSTER , clamp sujetador de huesos	394
GERSTER-LOWMAN , clamp sujetador de huesos	394
GILL , pinzas capsulares	83
GILL-FUCHS , pinzas para iris	83
GILL-HESS , pinzas para iris	82
GILLIES , ganchos	242
GILLIES , pinzas de disección con dientes	67
GILLIES , pinzas de disección tungsteno TUC	92
GILLIES , porta-agujas	185
GILLIES , porta-agujas tungsteno TUC	198
GILLS-WELSH , pinzas-tijeras para capsulotomía	140
GIL-VERNET , ganchos	249
GOELET , separadores	279
GOLDMAN-FOX (SPEZIAL) , tijeras para encías	136
GOLDMAN-FOX , tijeras para encías	136
GOLDMAN-FOX , tijeras tungsteno TUC	161
Goniómetros	373
GOOD , tijeras para amígdalas	119
GOOD-SCHWECKENDICK , tijeras para amígdalas	119
GORNEY , pinzas para preparaciones	111
GOSSET , separadores abdominales	298
GRADLE , pinzas depilatorias	76
GRAEFE , ganchos	243
GRAEFE , pinzas de fijación	84
GRAEFE , pinzas para iris	79
GRAEFE , tijeras oculares	126
Grapas	496
GRAY , pinzas-clamps para conducto biliar	40
GRAZIL , tijeras para cirugía	103
GREEN , pinzas de fijación	84
GREEN-SENN , ganchos	247
GROSS-MAIER , pinzas para pólipos	230, 231
GRUENWALD (JANSEN) , pinzas nasales	78
GRUENWALD , pinzas nasales	78
Gubias	417-426
GUTHRIE , ganchos	246
GUYON , pinzas-clamps para pedúnculos renales	38, 39
GUYON-ARTRAUMATIC , pinzas-clamps para pedúnculos renales	39

H

	Página		Página
HABERER , espátulas abdominales	308	Instrumentos para coger tendones	464
HAJEK , martillos	429	Instrumentos para medidas	371-375
HALLE , tijeras nasales	120	Instrumentos sensibilidad	376
HALSEY , porta-agujas	181	IOWA , agujas especiales	345
HALSEY , porta-agujas tungsteno TUC	195	ISRAEL , separadores	253
HALSTED , pinzas hemostáticas	16	IVES-FANSLER , esfinteroscopios	538
HALSTED-MOSQUITO , pinzas hemostáticas	15	IWANSON , círculo	375
HARMAN-BISHOP , pinzas para iris	82		
HARMS , pinzas para sutura	86	J	
HARRINGTON , separadores	267	JACKSON , laringoscopios con luz fría	363
HARRISON (PYE-SMITH) , pinzas para esterilización	564	JACKSON , pinzas para compresas y tamponamientos	78
HARTMANN , pinzas hemostáticas	14	JACOBI , agujas para ligaduras	217
HARTMANN , pinzas-gubias	469	JACOBS CHUCK , perforadores de mano	388
HARVEY , cizallas para cortar alambre	130	JACOBSON , micro-porta-agujas	210
HATFIELD , cucharillas cortantes	439	JACOBSON , micro-porta-agujas tungsteno TUC	204
HEANEY , pinzas-clamps para histerectomía	43	JACOBSON , porta-agujas	182
HEANEY , porta-agujas	184	JACOBSON , porta-agujas tungsteno TUC	194
HEANEY , separadores	277	JAMESON , calibre micrometro	372
HEANEY-BALLANTINE , clamps para histerectomía	43	JAMESON , pinzas musculares	87
HEANEY-KANTER , clamps para histerectomía	43	JAMESON , porta-agujas	184
HEANEY-REZAK , clamps para histerectomía	44	JANET , jeringas	348
HEATH , tijeras para ligaduras	129	JANSEN (GRUENWALD) , pinzas nasales	78
HEATH-RICHTER , pinzas para agrafes	224	JANSEN , cucharillas cortantes	440
HEGAR-OLSEN , porta-agujas	185	JANSEN , pinzas nasales	77
HEGAR-OLSEN , porta-agujas tungsteno TUC	198	JANSEN , separadores autoestaticos	284
HEGEMANN-DIETRICH , tijeras para cirugía vasculares	114	Jeringas	348
HEGENBARTH , pinzas para agrafes	224	Jeringas para cartucho ampullas	347
HEIFETZ , pinzas para coger	70	JEWELER , pinzas de disección tungsteno TUC	92
HEISS , pinzas hemostáticas	30	JOBSON-HORNE , porta-algodones	312
HELFERICH-BIER , sierras para amputación	384	JOHANSSON , trocares	329
HEMINGWAY , chucharillas cortantes	441	JOHNS-HOPKINS , clamps bulldog	11
HENAHAN , ganchito retractor de la muela del juicio	481	JOHNS-HOPKINS , pinzas para poner	11
HENLEY , separadores autoestaticos	288	JOHNS-HOPKINS , pinzas para preparaciones y ligaduras	32
HENNIG , separadores para escayola	319	JONES , pinzas de campo	51
HERRICK , pinzas-clamps para pedúnculos renales	39	JONES , pinzas para compresas	51
HESS , pinzas para iris	81	JOSEPH , ganchos	246
HESSBERG , agujas para ligaduras	217	JOSEPH , tijeras para preparaciones	112
HESS-GILL , pinzas para iris	82	JUDD-ALLIS , pinzas para coger tejidos y intestinos	518
HEYMANN , tijeras nasales	120	Juegos para diagnóstico	380, 381
HEYWOOD-SMITH , pinzas para esponjas	236		
HIBBS , cinceles	420	K	
HIBBS , gubias	420	KADER , separadores	273
HIRSCHMANN , anoscopios	539	KALT , micro-porta-agujas	212
HOEN , elevadores	448	KALT , micro-porta-agujas tungsteno TUC	205
HOESEL , separadores	265	KALT-ARRUGA , micro-porta-agujas	212
HOHMANN , elevadores para huesos	396, 397	KALT-CASTROVIEJO , micro-porta-agujas	212
Hojas de afeitar	177	KANTER-HEANEY , pinzas-clamps para histerectomía	43
Hojas de bisturíes	167, 168	KANTROWITZ , pinzas para preparaciones y ligaduras	35
Hojas de sierra para cortador eléctrico	323	KAPLAN-CRANE , pinzas para bolsas	98
HOKE , gubias	417	KATZIN , pinzas-tijeras para córnea	142
HOLINGER , laringoscopios	362	KATZIN-BARRAQUER , pinzas tijeras para córnea	142
HOPKINS , cuchillos para vendajes enyesados	318	KAYE , tijeras para Face-lift TUC	161
HOPKINS-JOHNS , clamps bulldog	11	KELLY (RICHARDSON) , separadores	264
HOPKINS-JOHNS , pinzas para poner	11	KELLY , pinzas hemostáticas	17
HOPKINS-JOHNS , pinzas para preparaciones y ligaduras	32	KELLY , pinzas para esponjas	235
HORNE-JOBSON , porta-algodones	312	KELLY , proctoscopios	540, 541
HÖSEL , porta-agujas	188	KELLY , separadores	268
HÖSEL , porta-agujas tungsteno TUC	201	KELLY , tijeras para fistulas	106
HOSPITAL-PROVIDENCE , pinzas hemostáticas	16	KELLY , tijeras tungsteno TUC	153
HRYNTSCHAK-YOUNG , boomerang porta-agujas	189	KELLY-RANKIN , pinzas hemostáticas	17
HUDSON , perforadores de mano	387	KELMAN-McPHERSON , pinzas para sutura	85
HUMBY , dermatomo	176	KERN , pinzas para huesos	456
HUNT , pinzas para coger	70	KERSTING , pinzas para anastomosis	528
HUNTER , pinzas para espinas	73	KILNER (RAGNELL) , tijeras para preparaciones	112
HURD , agujas para ligaduras	218	KILNER , ganchos	242
		KILNER , porta-agujas	181
I		KILNER , porta-agujas tungsteno TUC	195
Instrumentos para clavos Küntscher	488, 489		

	Página		Página
KIRBY , pinzas para iris	82	LANGENBECK-KOCHER , separadores	259
KIRSCHNER , agujas	499-502	LANGENBECK-MINI , ganchos	247
KIRSCHNER , estribos para extensión	400	LANGENBECK-PARKER , separadores	278
KIRSCHNER , separadores abdominales	303	LANGENBECK-RYDER , porta-agujas tungsteno TUC	202
KIRSCHNER , sondas conductoras	222	Laringoscopios	353-360
KIRSCHNER , tubos de aspiración	503	Laringoscopios con luz fría	357-360
KIRSCHNER-FERROZELL , sondas conductoras	222	LAWRENCE , pinzas para preparaciones y ligaduras	34
KLEINERT-KUTZ , ganchos	242	LEKSELL-STILLE , pinzas-gubias	473
KLEINERT-KUTZ , instrumentos para coger tendones	464	LEMPERT , pinzas-gubias	470
KLEINERT-KUTZ , pinzas-gubias	471	LERICHE , pinzas hemostáticas	16
KLIMA-ROSSEGER , agujas para biopsia	343	LESTER , pinzas de fijación	84
KLINIKUM BERLIN , pinzas para tubos	53	LEWIN , pinzas para huesos	454
KLINKENBERGH-LOTH , tijeras para cirugía vasculares	117	LEXER , cinceles	422, 423
KNAPP , ganchos	246	LEXER , gubias	422, 423
KNIGHTON , separadores autoestáticos	297	LEXER , tijeras para preparaciones	111
KNOWLES , tijeras para vendajes	133	LEXER , tijeras tungsteno TUC	158
KOCHER , agujas para ligaduras	216	LEXER-BABY , tijeras para preparaciones	111
KOCHER , pinzas-clamps estomacales y intestinales	522, 525	LICHTENBERG , porta-agujas	187
KOCHER , pinzas-clamps estomacales y intestinales Atrauma	525	LICHTENBERG , porta-agujas tungsteno TUC	201
KOCHER , retractors	260, 266	LICHTWITZ , trocares	330
KOCHER , separadores	251, 260, 266	Ligadores hemorroides	552-554
KOCHER , sondas conductoras	222	Limas de unas	579
KOCHER-DELICATE , pinzas hemostáticas	22	Limas para huesos	450
KOCHER-LANGENBECK , separadores	259	LINCOLN , tijeras para cirugía vasculares	117
KOCHER-OCHSNER , pinzas hemostáticas	20, 21	LINDEMANN , sierras para resección	384
KOERTE , separadores	252, 267	LISTER , pinzas para tapones	229
KÖNIG , sondas conductoras	221	LISTER , tijeras para vendajes	133, 134
KÖNIG , tijeras para unas encarnadas	135	LISTER , tijeras tungsteno TUC	162
KRAUSE , trocares	330	LISTER-EXCENTRIC , tijeras para vendajes	133
KROENLEIN , pinzas para coger	13	LISTON , cuchillos para amputación	172
KRONECKER , agujas para ligaduras	218	LISTON , pinzas cortantes para huesos	477, 480
KUEHNE , pinzas porta-laminillas	78	LISTON-KEY , pinzas cortantes para huesos	479
KÜNTSCHER , clavos intramedulares	492-494	LITTAUER , pinzas corta-unas	569
KÜNTSCHER , instrumentos para clavos	488, 489	LITTAUER , pinzas depilatorias	76
KUTZ-KLEINERT , ganchos	242	LITTAUER , tijeras para ligaduras	128
		LITTAUER-LISTON , pinzas cortantes para huesos	477
L		LITTLE , separadores	263
LA GRANGE , tijeras oculares	126	LITTLE , tijeras finas	123
LAHEY , pinzas-clamps para conducto biliar	37	LITTLEWOOD , pinzas per coger tejidos y intestinos	518
LAHEY , separadores	263	Llaves	349
LAMBOTTE , gubias	426	LLOYD-DAVIS , pinzas para anastomosis	529
LAMBOTTE , pinzas para huesos	460	LOCKHART-MUMMERY , sondas	311
LAMBOTTE , raspadores	443	LOCKLIN , tijeras para encias	136
Lámparas de alcohol	556	LOCKLIN , tijeras tungsteno TUC	162
Lámparas frontales	368	LOCKWOOD , pinzas para coger tejidos y intestinos	518
LAMPERT , pinzas de chalazión	89	LOCKWOOD-ALLIS , pinzas para coger tejidos y intestinos	518
LANDAU , trocares	329	LONDON-COLLEGE , pinzas para algodón y curaciones	95
LANDAU-SEGOND , pinzas-clamps para histerectomía	45	LONG , pinzas-clamps para histerectomía	44
LANDGRAF , pinzas para algodón y curaciones	97	LORENZ , tijeras para vendajes	133
LANDOLT , tijeras finas	124	LORNA , pinzas de campo	52
LANE , destornilladores	491	LORNA , pinzas para compresas	52
LANE , pinzas de campo	51	LOTH-KLINKENBERGH , tijeras para cirugía vasculares	117
LANE , pinzas de disección	61	LOTH-SCHOEMAKER , tijeras para ligaduras	128
LANE , pinzas para compresas	51	LOUTE , tensores cierra-hilos	407
LANE , pinzas para huesos	457	LOVELACE-DIXON , pinzas hemostáticas	26
LANE , pinzas-clamps estomacales	531	LOWER , pinzas-clamps para conducto biliar	37
LANGE , pinzas para agrafes	225	LUCAE , martillos	430
LANGE , tijeras para vestidos	132	LUCAE , pinzas nasales	77
LANGE-HOHMANN , elevadores para huesos	397	LUCAS , chucharillas cortantes	441
LANGENBECK , cuchillos para amputación	172	LUCAS , cinceles	417
LANGENBECK , elevadores	447	LUER , pinza hemorroidales, atrauma	48
LANGENBECK , pinzas para huesos	455	LUER , pinzas-gubias	469
LANGENBECK , porta-agujas	188	LUER , tubos de aspiración	336
LANGENBECK , porta-agujas tungsteno TUC	202	LUETHY-BECK , porta-agujas tungsteno TUC	202
LANGENBECK , raspadores	443		
LANGENBECK , separadores	254, 258	M	
LANGENBECK , sierras para resección	384	MAGILL , pinzas para catéteres	360
LANGENBECK-DELICATE , porta-agujas tungsteno TUC	202	MAIER-GROSS , pinzas para pólipos	230, 231

	Página		Página
MAIER-SIMS , pinzas para pólipos	239	MEYERDING , ganchos	247
Mangos de bisturíes	165-167	MEYERDING , separadores	273
Mangos de pila (sin pilas)	356	MEYERDING , separadores autoestaticos	294
Mangos de pila (sin pilas) Fibre Optic	360	MEYERDING-MARKHAM , separadores autoestaticos	294
Mangos para cánulas de liposucción y infiltración	338, 340	MICHEL , agrafes	225
Manómetros para la presión de la sangre	379	MICHEL , pinzas para agrafes	224
Manoplas de plomo	482	Micro- pinzas	71, 72
Marcador para Facelift	376	Micro, porta-agujas	204-213
MARKHAM-MEYERDING , separadores autoestaticos	294	Micro, tijeras	143-149
MARKWALDER , pinzas cortantes para huesos	477	Micro, tijeras Adventitia	145, 147
MARQUARDT , pinzas-gubias	470	Micro, tijeras Dissection	145, 147
MARTEL , pinzas hemostáticas para pericráneo	12	Micro, tijeras nerve	147
MARTEL-WILLET , pinzas hemostáticas para pericráneo	12	MICRO-ADSON , pinzas de disección	59
Martillos	427-433	MICRO-ADSON , pinzas de disección con dientes	59
Martillos de percusión	369, 370	MICRO-FRIEDMAN , pinzas-gubias	476
MARTIN , pinzas para cartílago	453	MICRO-MOSQUITO , pinzas hemostáticas	15
MARTIN , separadores	262	Micro-porta-agujas con mango redondo	206-209
MARTIN-CARTILAGE , tijeras	118	MICRO-RYDER , porta-agujas tungsteno TUC	193
MARTINI , cucharillas cortantes	440	MICROVASCULAR , porta-agujas TUC	193
MASS.-GENERAL-HOSPITAL (M.G.H.) , porta-agujas	183	MICRO-WULLSTEIN , tubos de aspiración	335
MASSE-ROBIN , separadores abdominales	306	MIDDELDORPF , separadores	264
MASSON , porta-agujas	184	MIKULICZ , pinzas-clamps para peritoneo	49
MASSON , porta-agujas tungsteno TUC	197	MIKULICZ , separadores	268
MATHIEU , espéculos rectales	536	MIKULICZ-BABY , pinzas-clamps para peritoneo	49
MATHIEU , porta-agujas	186	MILLER , Fibre Optic laringoscopios	359
MATHIEU , porta-agujas tungsteno TUC	199	MILLER , laringoscopios	355
MATHIEU , separadores	278	MILLER , pinzas para papel de articular	98
MATHIEU-DELICATE , porta-agujas	186	MILLER-SENN , separadores finas	250
MATHIEU-DELICATE , porta-agujas tungsteno TUC	199	MILLIGAN , separadores autoestaticos	288
MATHIEU-RYDER VASCULAR , porta-agujas tungsteno TUC	200	MILLS , tijeras para cirugía vasculares	116
MATHIEU-RYDER , porta-agujas tungsteno TUC	200	MINI , hojas de bisturíes	167
MATSON , raspadores	446	MINI , mangos de bisturíes	167
MAYFIELD , pinzas-gubias	470	MINI-FRIEDMAN , pinzas-gubias	468
MAYO ROBSON , pinzas-clamps estomacales y intestinales Atrauma	526	MINI-HOHMANN , elevadores para huesos	395
MAYO , cadres de esterilización	564	MINI-LAMBOTTE , gubias	426
MAYO , tijeras	105	MINI-LANGENBECK , ganchos	247
MAYO , tijeras tungsteno TUC	153	MINI-LEXER , cinceles	422
MAYO-ADAMS , separadores autoestaticos	296	MINI-LEXER , gubias	422
MAYO-HARRINGTON , tijeras	105	MISKIMON , separadores autoestaticos	289
MAYO-HEGAR , porta-agujas	184	MIXTER , pinzas para preparaciones y ligaduras	33, 34
MAYO-HEGAR , porta-agujas tungsteno TUC	192	MIXTER , tijeras para cirugía	104
MAYO-HEGAR-DELICATE , porta-agujas	184	MIXTER-BABY , pinzas para preparaciones y ligaduras	33
MAYO-HEGAR-DELICATE , porta-agujas tungsteno TUC	192	MIXTER-O'SHAUGNESSY , pinzas para preparaciones y ligaduras	33
MAYO-NOBLE , tijeras	105	MIXTER-OVERHOLT , pinzas para preparaciones y ligaduras	29
MAYO-ROBSON , pinzas-clamps estomacales y intestinales	521, 526	MOD. BONN , pinzas para iris	81
MAYO-RUSS. , pinzas para coger	66	MOD. BONN , pinzas para sutura	86
MAYO-STILLE , tijeras	105	MOD. BONN , tijeras finas	124
MAYO-STILLE , tijeras tungsteno TUC	154	MOD. TÜBINGEN (VANNAS) , pinzas-tijeras para catarata secundaria	139
MC GIVNEY , ligadores hemorroides	553	MOD. TÜBINGEN , pinzas para sutura	86
MC INDOE , pinzas cortantes para huesos	478	MOD. USA (SMITH) , tijeras para vendajes	133
MC INDOE , pinzas de disección	60	MOD. USA , separadores para escayola	319
MC INDOE , tijeras	118	MOD. USA , tijeras umbilicales	121
MC INTOSH , Fibre Optic laringoscopios	357	MOD. WIEN , instrumentas ligaduras	223
MC INTOSH , laringoscopios	353	MODELL TÜBINGEN , separadores	262
McDONALD , elevadores	448	MODELL USA , pinzas de disección	59
McDONALD , pinzas capsulorhexis	90	MODELL USA , pinzas de disección con dientes	59
McPHERSON , pinzas para sutura	85	MOELTGEN , goniómetros	373
MEAD , martillos	430	MOLDESTADT , ganchos	244
MEAD , pinzas-gubias	469	MOLLISON , separadores autoestaticos	289
MEEKER , pinzas para preparaciones y ligaduras	25	MOLT , raspadores	444
MENGHINI , agujas para biopsia	344	MOORE , perforadores de mano	387
MERIAM , pinzas para algodón y curaciones	96	MOORFIELD , pinzas para sutura	84
METZENBAUM , porta-agujas tungsteno TUC	199	MORGAN , anoscopios	541
METZENBAUM , tijeras para preparaciones	108	MORGAN , luz fria	541
METZENBAUM , tijeras tungsteno TUC	155, 156	MORRIS , separadores	261
METZENBAUM-BABY , tijeras para preparaciones	108	MOSQUITO-HALSTED , pinzas hemostáticas	15
METZENBAUM-DELICATE , tijeras para preparaciones	110	MOSQUITO-MICRO , pinzas hemostáticas	15
METZENBAUM-DELICATE , tijeras tungsteno TUC	158-160	MOYNIHAN , pinzas-clamps para histerectomía	44
METZENBAUM-NELSON , tijeras para preparaciones	109		

Multiple approach retractor	282	PEAN , pinzas para coger	13
MUMMERY-LOCKHART , sondas	311	PEAN-DELICATE , pinzas hemostáticas	22
MYRTLE LEAF , sondas	310	PEAN-ROCHESTER , pinzas hemostáticas	18, 19
N		Pedicura	568-579
NABATOFF , sondas para várices	312	PEERS , pinzas de campo	52
NAGER , agujas para ligaduras	219	PEERS , pinzas para compresas	52
NEFF , bisturíes para meniscos	467	PEET , pinzas para espinas	75
NEGUS , pinzas-clamps para conducto biliar	40	PELMANN , pinzas para tapones	235
NEIVERT , porta-agujas	181	PENNINGTON , pinzas para coger	13
NEIVERT , porta-agujas tungsteno TUC	195	PERCY , retractor para amputación	463
NELATON , sondas	310	Perforadores de mano	385-390
NELSON , pinzas para coger	66	PERRY , pinzas para algodón y curaciones	97
NELSON , trocares	328	PERTHES , perforadores de mano	390
NELSON-METZENBAUM , tijeras para preparaciones	109	PHANEUF , pinzas-clamps para histerectomía	45
NERVE , micro tijeras	147	PHILIPS , destornilladores	491
NEUMANN , tijeras para encías	137	PIERCE , trocares	330
NEW ORLEANS , porta-agujas	183	Piezas de conexión	349
NEW ORLEANS , porta-agujas tungsteno TUC	194	PIFFARD , cucharillas cortantes	436
NIRO , pinzas para hilos	401	PINARD , estetoscopios	377
NOBLE-MAYO , tijeras	105	Pinza-clamps para histerectomía	41-45
nopa PROFI , sierra para autopsia	484	Pinza-clamps para peritoneo	49, 50
NORTHBENT , tijeras para ligaduras	129	Pinzas	57-98
NOTO , pinzas para esponjas	234	Pinzas atrauma	91
NOYES , pinzas-tijeras para iridectomia	138	Pinzas auriculares	77
NUSSBAUM , pinzas-clamps estomacales y intestinales	523	Pinzas capsulares	83
		Pinzas capsulorhexis	90
O		Pinzas cortantes para huesos	477-480
O'BRIAN , tijeras finas	124	Pinzas de campo	51, 52
OBWEGESER , separadores para el ramo	257	Pinzas de chalazión	88, 89
OBWEGESER , separadores para partes blandes	255, 256	Pinzas de disección	57-65
OCHSNER , trocares	329	Pinzas de disección con dientes	57-65, 67, 68
OCHSNER-KOCHER , pinzas hemostáticas	20, 21	Pinzas de disección tungsteno TUC	92-94
O'CONNOR , ganchos	243	Pinzas de entropión	88
O'CONNOR-O'SULLIVAN , separadores abdominales	301	Pinzas de fijación	84
OEHLER , pinzas de disección tungsteno TUC	92	Pinzas de ligadura con plataforma	71, 72
OLIVECRONA , tijeras para cirugía vasculares	117	Pinzas de protección	390
OLLIER , separadores	253	Pinzas de relojero	69
OLSEN-HEGAR , porta-agujas	185	Pinzas de reposición	487
OLSEN-HEGAR , porta-agujas tungsteno TUC	198	Pinzas de sutura	97
OLSEN-HEGAR-USA , porta-agujas tungsteno TUC	198	Pinzas depilatorias	76
OMBREDANNE , martillos	427	Pinzas hemorroidales	47, 48
OSCINOPA , cortador eléctrico para vendajes duros	321	Pinzas hemorroidales, atrauma	48
OSCINOPA , sierra para autopsia	483	Pinzas hemostáticas	9-53
O'SHAUGNESSY-MIXTER , pinzas para preparaciones y ligaduras	33	Pinzas hemostáticas	13-23, 25-28
O'SULLIVAN-O'CONNOR , separadores abdominales	301	Pinzas hemostáticas delgadas	22
OTOSKOP UNI , juegos para diagnóstico	381	Pinzas hemostáticas finas	15
OVERHOLT , pinzas para preparaciones y ligaduras	24	Pinzas hemostáticas para amígdalas	27
OVERHOLT-BABY , pinzas para preparaciones y ligaduras	23	Pinzas hemostáticas para pericráneo	12, 26
OVERHOLT-GEISSENDOERFER , pinzas para preparaciones y ligaduras	23	Pinzas musculares	87, 88
OVERHOLT-MIXTER , pinzas para preparaciones y ligaduras	29	Pinzas nasales	77, 78
		Pinzas para agrafes	224, 225
P		Pinzas para anastomosis	528, 529, 532, 533
PALMER , clavos	496	Pinzas para aurícula	29
PARAMETRIUM , pinzas-clamps para parametrium	46	Pinzas para bolsas	98
PARAMETRIUM , tijeras tungsteno TUC	154	Pinzas para cartílago y menisco	453
PARKER , separadores	278	Pinzas para catéteres	360
PARKER-LANGENBECK , separadores	278	Pinzas para coger	12, 13, 66-68, 70, 316
PARTSCH , cinceles	418	Pinzas para coger intestinos	9, 517-519
PARTSCH , martillos	430	Pinzas para coger tejidos	9
PATON , micro-porta-agujas	212	Pinzas para coger tejidos y intestinos	517, 518
PAUFIQUE , pinzas para sutura	86	Pinzas para compresas	51, 52
PAYR , pinzas-clamps intestinales y estomacales	530	Pinzas para compresas y tamponamientos	78
PAYR , sondas conductoras	221	Pinzas para curaciones	95-97
PAYR-BABY , pinzas-clamps intestinales y estomacales	530	Pinzas para espinas	73-75
PAYR-SCHMIEDEN , sondas conductoras	221	Pinzas para esponjas	228-239
		Pinzas para esterilización	564
		Pinzas para hilos	401-403, 405, 406
		Pinzas para huesos	452, 454-462
		Pinzas para iris	79-82

	Página		Página
Pinzas para la cámara anterior	85	RABINER , martillos de percusión	369
Pinzas para papel de articular	98	RADOLF , pinza para unas	482
Pinzas para pólipos	229-239	RAGNELL (KILNER) , tijeras para preparaciones	112
Pinzas para poner	11	RAGNELL-DAVIS , separadores finas	250
Pinzas para preparaciones y ligaduras	23-25, 29, 31-36	RALK , perforadores de mano	389
Pinzas para quitar yeso	320	RALK , pinzas para espinas	75
Pinzas para romper hojas	177	RAMPLEY , pinzas para esponjas	238
Pinzas para sutura	85, 86	RANKIN-CRILE , pinzas hemostáticas	17
Pinzas para tapones	229-239	RANKIN-KELLY , pinzas hemostáticas	17
Pinzas para tener cristalino	90	Raspadores	442-446
Pinzas para torcer hilos tungsteno TUC	203	Rectoscopios	544-550
Pinzas para tubos	53	REHN , cuchillos para transplatación	175
Pinzas para unas	568-570	REILL , micro-porta-agujas	207
Pinzas porta-laminillas	78	REINER , cuchillos para vendajes enyesados	318
Pinzas saca-bocados para biopsia rectal	551	RESANO , pinzas-clamps estomacales y intestinales	527
Pinzas, micro	71, 72	Retractor para amputación	463
Pinzas-clamps bronquiales	30	REVERDIN , agujas	214
Pinzas-clamps de presión progresiva	47, 48	REVERDIN , espátulas abdominales	308
Pinzas-clamps estomacales	531	REYNOLDS , tijeras para preparaciones	112
Pinzas-clamps estomacales y intestinales	520-523	REZAK-HEANEY , pinzas-clamps para histerectomía	44
Pinzas-clamps estomacales y intestinales Atrauma	524-527	RIBBON , tijeras oculares	127
Pinzas-clamps intestinales y estomacales	520-523	RICARD , separadores abdominales	306
Pinzas-clamps intestinales y para anastomosis	532, 533	RICHARDSON (KELLY) , separadores	264
Pinzas-clamps para conducto biliar	37, 40	RICHARDSON-EASTMAN , separadores	264
Pinzas-clamps para parametrium	46	RICHTER , tijeras para cirugía	104
Pinzas-clamps para pedúnculos renales	37-39	RICHTER-HEATH , pinzas para agrafes	224
Pinzas-clamps para peritoneo	49, 50	RIGHBY , separadores autoestáticos	295
Pinzas-gubias	468-476	RIRAP , estetoscopios	378
Pistola lavatoria	590, 591	RISCOPE S , oftalmoscopio	381
PLESTER , separadores autoestáticos	295	RISCOPE S , oto-/oftalmoscopio	380
PLESTER , tubos de aspiración	335	ROBERTS , pinzas hemostáticas	30
POOLE , tubos de aspiración	332	ROBIN-MASSE , separadores abdominales	306
POOLE-BABY , tubos de aspiración	332	ROCHESTER-CARMALT , pinzas hemostáticas	27
Porta-agujas	180-213	ROCHESTER-PEAN , pinzas hemostáticas	18, 19
Porta-agujas micro	204-213	ROEDER , pinzas de campo	52
Porta-agujas tungsteno TUC	192-205	ROEDER , pinzas para compresas	52
Porta-algodones	311, 312	ROETTGEN-RUSKIN , pinzas-gubias	473
Porta-ligaduras	223	ROGGE , pinzas para esterilización	564
POTTS-DE MARTEL , tijeras para cirugía vasculares	116	ROLLET , ganchos	246
POTTS-SMITH , micro-porta-agujas	212	ROSCHKE , anoscopios	537
POTTS-SMITH , micro-porta-agujas tungsteno TUC	205	ROSSEGGER-KLIMA , agujas para biopsia	343
POTTS-SMITH , pinzas de disección	63	ROTTER , agujas para ligaduras	219
POTTS-SMITH , pinzas de disección con dientes	63	ROUX , separadores	277
POTTS-SMITH , pinzas de disección tungsteno TUC	92	ROWE , pinzas de reposición	487
POTTS-SMITH , tijeras	118	RUDD , ligadores hemorroides	554
POTTS-SMITH , tijeras para cirugía vasculares	113, 115	RUMEL , pinzas para preparaciones y ligaduras	30
POTTS-SMITH , tijeras tungsteno TUC	157	RUSKIN , pinzas-gubias	471, 475
PRATT , espéculos rectales	536	RUSKIN-LISTON , pinzas cortantes para huesos	478
PRATT , pinzas hemorroidales	47	RUSKIN-MINI , pinzas-gubias	471
PRATT , sondas	311	RUSS.-MAYO , pinzas para coger	66
PRECISA , manómetro para la presión de la sangre	379	RUSS.-MODELL , pinzas para coger	68
PRESBYTERIAN , pinzas para tubos	53	RYDER/FRENCH-EYE , porta-agujas tungsteno TUC	193
PRINCE , pinzas musculares	87	RYDER-LANGENBECK , porta-agujas tungsteno TUC	202
PRINCE , tijeras para amígdalas	119	RYDER-MATHIEU VASCULAR , porta-agujas tungsteno TUC	200
Proctoscopios	537-543	RYDER-MATHIEU , porta-agujas tungsteno TUC	200
PROVIDENCE-HOSPITAL , pinzas hemostáticas	16	RYDER-MICRO , porta-agujas tungsteno TUC	193
Punción/Agujas especiales	327-349		
Punzón	451	S	
PUTTI , escofinas	451	SALAH , agujas para biopsia	343
PYE-SMITH (HARRISON) , pinzas para esterilización	564	SALENIUS , bisturios para meniscos	467
PYNCHON-ANDREWS , tubos de aspiración	331	SAMII , pinzas para coger	70
Q		SANVENERO , tijeras para preparaciones	112
QUINBY , tijeras para encias	137	SAROT , pinzas-clamps bronquiales	30
QUINKE , agujas para biopsia	344	SAROT , porta-agujas	183
R		SAROT , porta-agujas tungsteno TUC	197
		SATINSKY , tijeras para cirugía vasculares	117
		SATTERLEE , sierras para amputación	384
		SATTLER , pinzas musculares	87

SAUERBRUCH , pinzas-gubias	474	SIMS , tijeras para ginecología	107
SAUERBRUCH , separadores	260, 274	SIMS , tijeras tungsteno TUC	155
SAWTELL-SCHNIDT , pinzas hemostáticas para amígdalas	27	SIMS-MAIER , pinzas para pólipos	239
SAWYER , espéculos rectales	534	SINGLEY-TUTTLE , pinzas para coger	66
SCALP-CONTOUR , separadores autoestaticos	294	SINUSCOPY , trocares	327
SCHAEDEL , pinzas de campo	51	SMILLIE , bisturios para meniscos	467
SCHAEDEL , pinzas para compresas	51	SMILLIE , separadores para rodilla	466
SCHANZ , agujas	503	SMITH (MOD. USA) , tijeras para vendajes	133
SCHUDE , cucharillas cortantes	435	SMITH , cizallas para cortar alambre	130
SCHINDLER , pinzas-clamps para peritoneo	50	SMITH-BUIE , espéculos rectales	536
SCHINK , dermatomo	176	SMITH-FERRIS , pinzas de disección con dientes	65
SCHMID , agujas especiales	345	SMITH-HEYWOOD , pinzas para esponjas	236
SCHMIEDEN , agujas para ligaduras	217	SMITH-PETERSEN , cinceles	419
SCHMIEDEN-PAYR , sondas conductoras	221	SMITH-PETERSEN , gubias	419
SCHMIEDEN-TAYLOR , tijeras para cirugía vasculares	116	SMITH-PETERSON , pinzas-gubias	475
SCHNIDT-SAWTELL , pinzas hemostáticas para amígdalas	27	SMITH-POTTS , micro-porta-agujas	212
SCHOEMAKER , tijeras para bocio	119	SMITH-POTTS , micro-porta-agujas tungsteno TUC	205
SCHOEMAKER-LOTH , tijeras para ligaduras	128	SMITH-POTTS , pinzas de disección tungsteno TUC	92
SCHUHKNECHT , separadores autoestaticos	289	SMITH-POTTS , tijeras para cirugía vasculares	113, 115
SCHUKNECHT , cizallas para cortar alambre	130	SMITH-POTTS , tijeras tungsteno TUC	157
SCHULZE-BERGMANN , espéculos rectales	535	SNELLEN , pinzas de entropión	88
SCHUMACHER , tijeras umbilicales	121	SNITMAN , separadores autoestaticos	284
SCHWECKENDICK-GOOD , tijeras para amígdalas	119	Sondas	310, 311
SCUDDER , pinzas-clamps estomacales y intestinales	523, 526	Sondas conductoras	220-222
SCUDDER , pinzas-clamps estomacales y intestinales Atrauma	526	Sondas para várices	312
SEBILEAU , elevadores	447	SPENCER , tijeras para ligaduras	128
SEDILLOT , raspadores	445	SPENCER-DELICATE , tijeras para ligaduras	128
SEGOND , pinzas-clamps para histerectomía	45	SPENCER-WELLS , pinzas hemostáticas	14
SEGOND-LANDAU , pinzas-clamps para histerectomía	45	SPRATT , cucharillas cortantes	435
SELLORS-CRAFOORD , pinzas para aurícula	29	ST. MARKS , separadores	275
SEMB , pinzas cortantes para huesos	480	ST. MARTIN , pinzas para sutura	85
SEMB , pinzas para huesos	456	STACKE , sondas	310
SEMB , pinzas-gubias	472	STADLER-BRAUN , tijeras para episiotomía	121
SEMB , raspadores	446	STANDARD , pinzas de disección	57
SEMKEN , pinzas de disección	60	STANDARD , pinzas de disección con dientes	57
SEMKEN , pinzas de disección con dientes	61	STANDARD , tijeras para cirugía	102
SEMKEN , pinzas de disección tungsteno TUC	92	STANDARD , tijeras para encías	137
SEMM , separadores abdominales	303	STANDARD , tijeras tungsteno TUC	152, 153
SENN-GREEN , ganchos	247	STANDARD , trocares	327
SENNING (SCHWED. MODELL) , porta-agujas	183	STEINBACH , martillos	432
SENNING (SCHWED. MODELL) , porta-agujas tungsteno TUC	194	STEINMANN , clavos	399, 497, 498
SENN-MILLER , separadores finas	250	STEINMANN , instrumentos para coger tendones	464
SENN-MILLER-BABY , separadores finas	250	STELLBRINK , pinzas-gubias	468
Separadores	242-308	STERNUM , pinzas para torcer hilos tungsteno TUC	203
Separadores abdominales	298-307	STERNUM , pinzas TUC para hilos	403
Separadores autoestaticos	283, 284, 287-297	STEVENS , micro-porta-agujas	212
Separadores con iluminación de luz fría	281	STEVENS , pinzas para iris	80
Separadores espinales	250	STEVENS , tijeras para tenotomía	126
Separadores finas	250	STEVENS , tijeras tungsteno TUC	161
Separadores optico por endoscopio	281, 282	STIEGLITZ , pinzas para espinas	75
Separadores para dedos	283	STILLE , cinceles	421
Separadores para el ramo	257	STILLE , cizallas para escayola	320
Separadores para escayola	319	STILLE , gubias	421
Separadores para la cirugía de la mano	285	STILLE , perforadores de mano	386
Separadores para partes blandes	255, 256	STILLE , pinzas de disección	65
Separadores para rodilla	466	STILLE , pinzas de disección con dientes	65
Separadores para tendones	465	STILLE , pinzas-clamps para pedúnculos renales	38
SEUTIN , tijeras para vendajes	134	STILLE , pinzas-gubias	472
SHORTBENT , tijeras para ligaduras	129	STILLE-BARRAYA , pinzas de disección con dientes	65
SIEBOLD , tijeras para ginecología	107	STILLE-DOYEN , separadores	266
Sierra para autopsia	483-485	STILLE-LISTON , pinzas cortantes para huesos	479
Sierras	384, 482-485	STILLE-LUER , pinzas-gubias	473
Sierras para abrir anillos	482	STILLE-MAYO , tijeras	105
Sierras para amputación y resección	384	STILLE-MAYO , tijeras tungsteno TUC	154
Sierras para vendajes enyesados	318	STILLE-RUSKIN , pinzas-gubias	472
Silletas	563	STILLE-SHERMAN , perforadores de mano	385
SIMON , bisturios para fistulas	174	STRATTE , porta-agujas	185
SIMON , separadores	262	STRATTE , porta-agujas tungsteno TUC	197
SIMS , espéculos rectales	534	STRAUSS , rectoscopios	548

	Página		Página
STRULLY , tijeras para cirugía vasculares	115	TOENNIS-ADSON , tijeras para cirugía vasculares	116
SULLIVAN (BROPHY) , tijeras finas	123	TOENNIS-ADSON-DELICATE , tijeras tungsteno TUC	161
SULLIVAN , tijeras para encias	137	TOHOKU-JAPAN , pinzas de campo	52
Super Cut Tijeras SC	101	TOHOKU-JAPAN , pinzas de compresas	52
Sutura	180-225	Tornillos para huesos	505-512
SYME , agujas para ligaduras	216	TOWNLEY , calibrador	372
T		TRAVERS , separadores autoestaticos	288
Tarros	562	Trefina para vandajes enyesados	318
TAYLOR , elevadores para huesos	398	TRELAT , agujas para ligaduras	218
TAYLOR , martillos de percusión	369	TROCAR , agujas para biopsia	344
TAYLOR , pinzas de disección	61	Trocars	327-330
TAYLOR , pinzas de disección con dientes	61	TROELTSCH (WILDE) , pinzas auriculares	77
TAYLOR , separadores espinales	250	TROEMNER , martillos de percusión	370
TAYLOR-CUSHING , pinzas de disección tungsteno TUC	93	TROUTMAN (CORNEAL) , pinzas para iris	82
TAYLOR-SCHMIEDEN , tijeras para cirugía vasculares	116	TROUTMAN , micro-porta-agujas	207
Tensores cierra-hilos	407	TROUTMAN , pinzas para córnea	141
TERRIER , pinzas hemostáticas	14	TROUTMAN-BARRAQUER , micro-porta-agujas	206
TERSON , pinzas para iris	83	TROUTMAN-CHRIS , pinzas para romper hojas	177
THIERSCH , cuchillos para transplatación	175	TÜBINGER MODELL , separadores	262
THIESS , martillos	430	TÜBINGER MODELL , separadores autoestaticos	296
THOMS-ALLIS , pinzas para coger tejidos y intestinos	518	Tubos de aspiración	503
THOREK , tijeras para preparaciones	111	Tubos de aspiración	331-337
THORPE , calibrador	372	TUDOR-EDWARDS , pinzas cortantes para huesos	479
Tijeras	102-162	Tuerce-hilos	223
Tijeras abdominales	106	TUFFIER , espátulas abdominales	308
Tijeras cuticulares	135	TUFFIER , pinzas para coger	12
Tijeras finas	122-124	TUFFIER , separadores	267
Tijeras micro	143-149	TUOHY , agujas para biopsia	344
Tijeras nasales	119, 120	TURNBULL , pinzas corta-unas	568
Tijeras oculares	125-127, 138-143	TUTTLE-SINGLEY , pinzas para coger	66
Tijeras para amígdalas	119	U	
Tijeras para bocio	119	UCKERMANN , porta-algodones	312
Tijeras para capsulotomía	140	ULRICH , pinzas para huesos	462
Tijeras para cartilago	118	ULRICH , pinzas para pólipos	229
Tijeras para catarata secundaria	139	UNIVERSAL , cizallas para cortar alambre	130
Tijeras para cirugía	102-105, 122	UNIVERSAL , perforadores de mano	389
Tijeras para cirugía vasculares	113-117	UNIVERSAL , pinzas-gubias	468
Tijeras para córnea	141-143	UNIVERSAL , tijeras para vendajes	132
Tijeras para coronaria	115	UNIVERSAL , tijeras tungsteno TUC	162
Tijeras para coronas	130, 131	UNIVERSAL , trocars	327
Tijeras para disección	118	US TYPE-BALFOUR , separadores abdominales	299
Tijeras para encias	136, 137	V	
Tijeras para enterótomos	118	VACUNOPA , vacuum cleaner	324
Tijeras para episiotomía	121	VAN BUREN , pinzas para huesos	452
Tijeras para estrabismos	126	VANNAS MOD. TÜBINGEN , pinzas-tijeras para catarata secundaria	139
Tijeras para Face-lift TUC	161	VANNAS , pinzas-tijeras para catarata secundaria	139
Tijeras para fistulas	106	Vendajes	318-324
Tijeras para ginecología	105-107	VERBRUGGE , pinzas para huesos	459
Tijeras para incisión	104	VERNET-GIL , ganchos	249
Tijeras para iridectomía	138	VERNIER , calibrador	372, 373
Tijeras para ligaduras	128, 129	VERRES , agujas especiales	345
Tijeras para lobectomía	118	VIRCHOW , cuchillos para cerebro	173
Tijeras para nervios	111	WISE , pinzas de ligadura con plataforma	71
Tijeras para neurocirugía	115-117	VOLKMANN , cucharillas cortantes	434, 440
Tijeras para preparaciones	108-112	VOLKMANN , separadores	251, 252
Tijeras para tenotomía	126, 140	W	
Tijeras para unas	135	WACHENFELDT , pinzas para agrafes	224
Tijeras para unas encarnadas	135	WAGNER , tijeras finas	122
Tijeras para vendajes	132-134	WALB , cuchillos para órganos	173
Tijeras para vestidos	132, 133	WALDMANN , tijeras para episiotomía	121
Tijeras Super-Cut SC	101	WALTER , separadores	250
Tijeras tungsteno TUC	152-162	WALTER-CARMALT , pinzas para espinas	73
Tijeras umbilicales	121		
TOENNIS , pinzas para preparaciones y ligaduras	36		
TOENNIS , porta-agujas	188		
TOENNIS , porta-agujas tungsteno TUC	201		
TOENNIS , tijeras para cirugía vasculares	116		

WALTON , pinzas para pólipos	239
WALTON , separadores autoestáticos	297
WALTON , sierras para abrir anillos	482
WALTON , tijeras finas	124
WALTON-LISTON , pinzas cortantes para huesos	478
WALTON-YANKAUER , tubos de aspiración	331
WANGENSTEEN , pinzas de disección	65
WANGENSTEEN , pinzas de disección tungsteno TUC	94
WANGENSTEEN , porta-agujas	185
WANGENSTEEN , porta-agujas tungsteno TUC	197
WANGENSTEEN-DELICATE , porta-agujas	185
WARTENBERG , instrumentos sensibilidad	376
WATSON , dermatomo	176
WAUGH , pinzas para coger	67
WEBSTER , porta-agujas	181
WEBSTER , porta-agujas tungsteno TUC	195
WECKER , pinzas-tijeras para iridectomía	138
WEITLANER , separadores autoestáticos	287
WEITLANER-BABY , separadores autoestáticos	287
WELLS-SPENCER , pinzas hemostáticas	14
WERTHEIM , pinzas-clamps para histerectomía	41, 42
WERTHEIM , porta-agujas	185
WERTHEIM , porta-agujas tungsteno TUC	198
WERTHEIM , tijeras	106
WERTHEIM-CULLEN , pinzas-clamps para histerectomía	44
WESTCOTT , micro-tijeras	143
WESTCOTT , pinzas-tijeras para tenotomía	140
WESTERMARK , pinzas para tapones	232
WIGMORE , cuchillas para vendajes enyesados	318
WIKSTROEM , pinzas para preparaciones y ligaduras	41
WILDBERG , grapas	496
WILDE (TROELTSCH) , pinzas auriculares	77
WILLET-MARTEL , pinzas hemostáticas para pericráneo	12
WILLIAMS , pinzas para coger tejidos e intestinos	518
WILLIGER , cucharillas cortantes	440
WILLIGER , elevadores	447
WILLIGER , martillos	428
WILLIGER , raspadores	444
WILMER , tijeras oculares	126
WISCONSIN (FOREGGER) , Fibre Optic laringoscopios	358
WISCONSIN (FOREGGER) , laringoscopios	354
WOLFF , pinzas para quitar yeso	320
WULLSTEIN MICRO , tubos de aspiración	335
WULLSTEIN , separadores autoestáticos	289

Y

YANCOSKIE , separadores de abdominoplastia	280
YANKAUER , tubos de aspiración	331
YANKAUER-WALTON , tubos de aspiración	331
YEOMAN , pinzas saca-bocado para biopsia rectal	551
YOUNG-HRYNTSCHAK , boomerang porta-agujas	189

Z

ZAUFAL-JANSEN , pinzas-gubias	471
ZENKER , pinzas para preparaciones y ligaduras	32
ZENKER , separadores	272
ZIEGLER , pinzas depilatorias	76
ZWEIFEL , porta-agujas	187
ZWEIFEL , porta-agujas tungsteno TUC	202

Index

	Page		Page
A			
Accessoires pour broches centro-médullaires	490	BABY/DUPLEX-LIGHTWEIGHT , stéthoscopes	378
Accessoires pour power drills	392	BABY-ADSON , pinces à dissection	25
Accu power drill	391	BABY-BALFOUR , écarteurs abdominaux	299
Accumulateur / chargeur d'accus	393	BABY-COLLIN , écarteurs abdominaux	304
ADAMS-MAYO , écarteurs autostatiques	296	BABY-CRILE-WOOD , porte-aiguilles	182
ADISON , pince-guide pour perforateurs	390	BABY-CRILE-WOOD , porte-aiguilles tungstène TUC	196
ADLERKREUTZ , pinces à griffes	65	BABY-DOYEN , pinces-clamps stomacales et pour l'intestin	520
ADSON , canules d'aspiration	335	BABY-KOCHER , pinces-clamps stomacales et pour l'intestin	521, 526
ADSON , écarteurs autostatiques	290, 291	BABY-LEXER , ciseaux à dissection	111
ADSON , élévateurs	449	BABY-METZENBAUM , ciseaux à dissection	108
ADSON , pinces à dissection et à griffes	59, 60	BABY-MIKULICZ , pinces-clamps pour le péritoine	49
ADSON , pinces à dissection et à ligatures	25	BABY-MIXTER , pinces à dissection et à ligatures	33
ADSON , pinces à dissection tungstène TUC	93	BABY-OVERHOLT , pinces à dissection et à ligatures	23
ADSON , porte-aiguilles	183	BABY-POOLE , canules d'aspiration	332
ADSON-ANDERSON , écarteurs autostatiques	290	BABY-SENN-MILLER , écarteurs fins	250
ADSON-BABY , écarteurs autostatiques	292	BABY-WEITLANER , écarteurs autostatiques	287
ADSON-BABY , pinces à dissection et à ligatures	25	BACKHAUS , pinces à champs	52
ADSON-BECKMANN , écarteurs autostatiques	293	BACON , pinces-gouges	470
ADSON-BROWN , pinces à griffes	60	BAINBRIDGE , pinces hémostatiques	27
ADSON-MICRO , pinces à dissection et à griffes	59	BAINBRIDGE , pinces-clamps stomacales et pour l'intestin Atrauma	524
ADSON-TOENNIS , ciseaux vasculaires	116	BALFOUR US-TYPE , écarteurs abdominaux	299
ADVENTITIA , micro-ciseaux	145, 147	BALFOUR , écarteurs abdominaux	299, 300
Agrafes	225	BALFOUR-BABY , écarteurs abdominaux	299
Agrafes	496	BALL & SOCKET , pinces a champs	52
Aiguilles à ligatures	215-219	BALLANTINE-HEANEY , pinces à hystérectomie	43
Aiguilles de Reverdin	214	BALLENGER-FOERSTER , pinces à éponges	237
Aiguilles d'introduction	346	BARRAQUER , ciseaux à iridectomie	138
Aiguilles pour biopsie	343, 344	BARRAQUER , micro-porte-aiguilles	206
Aiguilles spéciales	345	BARRAQUER , pinces à épiler les cils	76
Air power drill	391	BARRAQUER , pinces pour la chambre antérieure	85
ALAN PARKS , anuscopes	537	BARRAQUER-KATZIN (COLIBRI) , pinces à iris	82
ALDERDYCE , élévateurs	448	BARRAQUER-KATZIN , ciseaux corneales	142
Aléssoir pour vis d'ostéo-synthèse	513	BARRAQUER-TROUTMAN , micro-porte-aiguilles	206
ALEXANDER , ciseaux-burins	418	BARRAYA-STILLE , pinces à griffes	65
ALEXANDER , rugines-raspatoires	446	Bassins réniformes	559
ALLIS , pinces pour saisir le tissu	9	BAUMGARTNER , porte-aiguilles	184
ALLIS , pinces pour saisir le tissu et l'intestin	517	BECK-LUETHY , porte-aiguilles tungstène TUC	202
ALLIS-ADAIR , pinces pour saisir le tissu et l'intestin	517	BECKMANN , écarteurs autostatiques	292
ALLIS-BABY , pinces pour saisir le tissu et l'intestin	517	BECKMANN-ADSON , écarteurs autostatiques	293
ALM , écarteurs autostatiques	283	BECKMANN-EATON , écarteurs autostatiques	293
ALY , instruments sensibilités	376	BEEBEE , ciseaux à couronnes	130, 131
ANDERSON-ADSON , écarteurs autostatiques	290	BEER , pinces à épiler les cils	76
ANDREWS-PYNCHON , canules d'aspiration	331	BEESON , pinces écartante pour appareils plâtrés	319
Anesthésie	353-363	BENGOLEA , pinces hémostatiques	28
Anuscopes	537-543	BENSAUDE , anuscopes	540
ANVIL , pinces à ongles	571	BERENS , pinces musculaires	88
ARLT-FISCHER , pinces à iris	80	BERGMANN , ciseaux pour pansements	132
ARRUGA , micro-porte-aiguilles	212	BERGMANN , marteaux	427
ARRUGA , pinces capsulaires	83	BERGMANN , scie pour appareils plâtrés	318
ARRUGA , porte-aiguilles	180	BERKE , pinces à chalazion	89
ARRUGA , porte-aiguilles tungstène TUC	201	BERLINER , marteaux-percuteurs	370
ARRUGA-KALT , micro-porte-aiguilles	212	BERNHARD , pinces à champs	51
Arthroscopie	408-415	BEYER , pinces-gouges	471
AUSTIN , pinces à ligatures avec plate-forme	71	BILLROTH , écarteurs	252
AUSTRALIA , écarteurs	283	BINKHORST , pinces capsulaires	83
AUSTRALIA , écarteurs de la chirurgie de la main	285	BIRCHER , bistouris à ménisques	467
AYER , pinces à chalazion	88	BIRCHER-GANSKE , daviers à ménisques	453
B			
BABCOCK , pinces pour saisir l'intestin	9, 519	BIRKETT , pinces à dissection et à ligatures	41
BABINSKY , marteaux-percuteurs	369	BISHOP-HARMAN , pinces à iris	82
BABY KOCHER , pinces-clamps stomacales e pour l'intestin Atrauma	526	Bistouris	165-177
		Bistouris à abcès	174
		Bistouris à fistules	174
		Bistouris à ménisques	467
		Bistouris pour opérations	169-171
		BLASCOVICS , pinces musculaires	87

	Page		Page
BLOND , anoscopes	542, 543	CARMALT-WALTER , pinces à échardes	73
BLOUNT , écarteurs pour le genou	466	CAROLL , goniomètres	373
BLOUNT , leviers à os	398	CAROLL , instruments pour saisir les tendons	464
BLUEPOWER , scie électrique pour appareils plâtrés	322	CARREL , pinces hémostatiques	14
BLUMENTHAL , pinces-gouges	469	CARROLL , porte-aiguilles	182
BÖHLER , étriers à extension	399	CARROLL , porte-aiguilles tungstène TUC	194
BÖHLER , pinces-gouges	471	CARTILAGE-MARTIN , ciseaux	118
Boîtes	559, 561, 562	CASTROVIEJO , cercle	375
Boîtes pour instruments	562	CASTROVIEJO , ciseaux à iridectomie	138
Boîtes pour stériliser des aiguilles	560	CASTROVIEJO , ciseaux corneales	141
BOLEY , calibres	373	CASTROVIEJO , micro-porte-aiguilles	210, 213
BONACCOLTO , pinces pour sutures	85	CASTROVIEJO , micro-porte-aiguilles tungstène TUC	204, 205
BONNEY , pinces à dissection tungstène TUC	94	CASTROVIEJO , pinces à fixer	84
BONNEY , pinces à griffes et pour saisir les tissus	68	CASTROVIEJO , pinces capsulaires	83
Boomerang porte-aiguilles	189	CASTROVIEJO , pinces pour sutures	85
BÖTTCHER , ciseaux pour les amygdales	119	CASTROVIEJO , pincettes pour casser les lames	177
BOYNTON , porte-aiguilles	180	CASTROVIEJO-EPKER , cercle	375
BOYNTON , porte-aiguilles tungstène TUC	201	CASTROVIEJO-KALT , micro-porte-aiguilles	212
BOYS-ALLIS , pinces pour saisir le tissu et l'intestin	518	CATLIN , couteaux à amputation	172
BOZEMANN , instruments pour la suture	223	CHADWICK , ciseaux oculaires	126
BOZEMANN , pinces à tampons	233	CHAPUT , pinces à saisir	12
BOZEMANN , porte-aiguilles	182	CHARRIERE , scies à amputation	384
BOZEMANN , porte-aiguilles tungstène TUC	197	CHEATLE , pinces à stérilisation	564
BOZEMANN-DOUGLAS , pinces à tampons	233	CHERON , pinces à tampons	234
BRAND , instruments pour saisir les tendons	464	CHILDE , pinces pour agrafes	225
BRAUN-STADLER , ciseaux à épisiotomie	121	CHRIS-TROUTMAN , pincettes pour casser les lames	177
BRIDGE , pinces à dissection et à ligatures	34	CHURCH , ciseaux vasculaires	117
Broches	499-502	Cisailles pour appareils plâtrés	134
Broches à crochet	495	Cisailles pour fils	130
BRODIE , sondes	311	Ciseaux	102-162
BROPHY (SULLIVAN) , ciseaux fins	123	Ciseaux à chirurgie	102-105, 122
BROPHY , pinces à dissection et à griffes	63	Ciseaux à couronnes	130, 131
Brosses pour nettoyer	583-589	Ciseaux à dissection	108-112
BROWN , pinces à griffes	64	Ciseaux à envies	135
BROWN , porte-aiguilles	183	Ciseaux à épisiotomie	118, 121
BROWN-ADSON , pinces à griffes	60	Ciseaux à gencives	136, 137
BROWNE-DENIS , écarteurs abdominaux	301	Ciseaux à goitre	119
Brucelles pour coton	95-97	Ciseaux à gynécologie	105-107
BRUNNER , aiguilles à ligatures	216, 217	Ciseaux à incision	104
BRUNNER , écarteurs	263	Ciseaux à iridectomie	125, 138
BRUNNER , pinces-clamps stomacales et pour l'intestin	520	Ciseaux à ligatures	128, 129
BRUNNER , sondes conductrices	220	Ciseaux à lobectomie	118
BRUNNER-FERROZELL , sondes conductrices	222	Ciseaux à ongles	135
BRUNS , cisailles pour appareils plâtrés	134	Ciseaux à préparation	108-112, 118
BRUNS , curettes tranchantes	434, 437	Ciseaux à strabisme	126
BRYANT , pinces à éponges	228	Ciseaux à ténotomie	126, 140
BUCK , ciseaux à ligatures	129	Ciseaux abdominaux	106
BUCK , marteaux-percuteurs	369	Ciseaux cornéales	141-143
BUELAU , trocars	328	Ciseaux coronaires	115
Bulldog clamps	10, 11	Ciseaux fins	122-124
BUNNELL , instruments à écorcher les tendons	465	Ciseaux micro	143-149
BUNNELL , perforateurs à main	388	Ciseaux nasaux	119, 120
BUSCH , ciseaux pour le cordon ombilical	121	Ciseaux oculaires	125-127, 138-143
BYRD , canules d'aspiration	332	Ciseaux pour capsulotomie	140
		Ciseaux pour chirurgie vasculaire	113-117
C		Ciseaux pour Face-lift	161
CAIRNS , pinces hémostatiques	22	Ciseaux pour fistules	106
Calibres	372, 373	Ciseaux pour le cartilage	118
CAMPBELL , trocars	328	Ciseaux pour le cataracte secondaire	139
CANNY RYALL , écarteurs	279	Ciseaux pour le cordon ombilical	121
Canules d'aspiration	503	Ciseaux pour les amygdales	119
Canules d'aspiration	331-337	Ciseaux pour nerfs	111
Canules de liposuction et infiltration	339, 341, 342	Ciseaux pour neurochirurgie	115-117
CAPLAN , ciseaux nasaux	119	Ciseaux pour ongles incarnés	135
CARDINALE , ciseaux à gynécologie	107	Ciseaux pour pansements	132-134
CARDINALE , ciseaux à gynécologie tungstène TUC	155	Ciseaux super cut SC	101
CARDIOPHON , stéthoscopes	378	Ciseaux tungstène TUC	152-162
CARMALT-ROCHESTER , pinces hémostatiques	27	Ciseaux-burins	417-426
		Clamps bulldog	10, 11

	Page		Page
CLAR 55 , éclairateurs frontaux	368	Curettes tranchantes	434-441
CLAR STANDARD , éclairateurs frontaux	368	CUSHING , crochets très fins	244, 248
CLASSON , ciseaux vasculaires	117	CUSHING , écarteurs spinaux	250
CLAUS , aiguilles à ligatures	218	CUSHING , perforateurs à main	387
CLAUS-EICKEN , aiguilles à ligatures	219	CUSHING , pinces à dissection et à griffes	62
CLEVELAND , pinces coupantes à os	478	CUSHING , pinces à dissection tungstène TUC	93
CLEVELAND , pinces-gouges	468	CUSHING-TAYLOR , pinces à dissection tungstène TUC	93
CLEVELAND-GARDNER , pinces coupantes à os	477	Cuvettes	559, 562
Clips de stérilisation	564	CZERNY , écarteurs	279
Clous	492-498	CZERNY , spéculums rectaux	534
Clous à os	496		
CLOWARD HIBBS SPRATT , curettes tranchantes	437	D	
COAKLEY , trocars	330	DAHMEN , ciseaux-burins	425
COBB , ciseaux-burins	424	DAHMEN , ostéotomes	425
COBB , curettes tranchantes	439	DANDY , ciseaux vasculaires	115
COBB , élévateurs	449	DANDY , pinces hémostatiques pour le cuir chevelu	26
COGSWELL , canules d'aspiration	336	DARLING , écarteurs autostatiques	295
COLIBRI (BARRAQUER-KATZIN) , pinces à iris	82	DAVIDSON , écarteurs	276
COLLEGE LONDON , précelles(Brucelles) pour coton	95	Daviers à cartilage	453
COLLER , pinces hémostatiques	17	Daviers à ménisques	453
COLLIER , porte-aiguilles	180	Daviers à ménisques	466
COLLIN , bistouris	170	Daviers à os	394
COLLIN , couteaux à amputation	172	Daviers porte-os	452, 454-462
COLLIN , dynamomètre	374	DAVIS-RAGNELL , écarteurs fins	250
COLLIN , écarteurs abdominaux	304, 305	DE BAKEY , canules d'aspiration	331
COLLIN , manches pour bistouris	166	DE BAKEY , ciseaux tungstène TUC	157
COLLIN , marteaux	429	DE BAKEY , ciseaux vasculaires	113, 116
COLLIN , pinces à saisir	13	DE BAKEY , dilateurs vasculaires	314
COLLIN , pinces à tampons	234	DE BAKEY , pinces à dissection tungstène TUC	94
COLLIN , pinces pour agrafes	224	DE BAKEY , pinces atrauma	91
COLLIN-BABY , écarteurs abdominaux	304	DE BAKEY , porte-aiguilles tungstène TUC	192
COLLIN-DUVAL , pinces pour saisir les tissus	66	DE LA ROZA , aiguilles à ligatures	217
COLLIN-HARTMANN , écarteurs	277	DE MARTEL-POTTS , ciseaux vasculaires	116
CONE , écarteurs autostatiques	292	DE MARTEL-WOLFSON , pinces-clamps à anastomose	532, 533
CONVERSE , porte-aiguilles tungstène TUC	195	DE MARTEL-WOLFSON , pinces-clamps intestinales	532, 533
CONVERSE-DERF , porte-aiguilles	180	DEAN , ciseaux à gencives	136
COOLEY , canules d'aspiration	333	DEAN , ciseaux tungstène TUC	162
COOLEY , dilateurs vasculaires	313	DEAN-DELICATE , ciseaux à gencives	136
COOPER , aiguilles à ligatures	216	DEAVER , ciseaux à chirurgie	104
CORNEAL (TROUTMAN) , pinces à iris	82	DEAVER , écarteurs	269-271
CORWIN , pinces à fil TUC	403	DEJERINE , marteaux-percuteurs	370
CORWIN , pinces à torsader le fil tungstène TUC	203	DELICATE-METZENBAUM , ciseaux tungstène TUC	158-160
CORYLLOS , écarteurs	274	DELICATE-TOENNIS-ADSON , ciseaux tungstène TUC	161
COTTLE KAZANJIAN , pinces coupantes à os	477	DEMEL , tendeurs serre-fils	407
COTTLE , ciseaux nasaux	120	DENIS-BROWNE , écarteurs abdominaux	301
COTTLE , marteaux	428	DERF , porte-aiguilles	180
COTTLE , pinces nasales	77	DERF , porte-aiguilles tungstène TUC	195
COUPLAND , canules d'aspiration	337	DERF-CONVERSE , porte-aiguilles	180
Couteaux à amputation	172	Dermatome	176
Couteaux à autopsie	173	DESCHAMPS , aiguilles à ligatures	215
Couteaux à cerveaux	173	DESJARDINS , pinces-clamps pour voies biliaires	40
Couteaux à transplantation	175	DESMARRES , crochets très fins	248
Couteaux pour appareils plâtrés	318	DESMARRES , pinces à chalazion	88
CRAFOORD , ciseaux	118	Diagnostic	367-382
CRAFOORD , pinces-clamps à bronches	30	DICK , pinces à anastomose	528
CRAFOORD-SELLORS , pinces auriculaires	29	DIEFFENBACH , bistouris	170, 171
CRANE-KAPLAN , pinces pour cul-de-sac	98	DIEFFENBACH , bistouris à abcès	174
CREGO , leviers à os	398	DIEFFENBACH , clamps bulldog	11
CRILE , pinces hémostatiques	17	DIETRICH , micro-porte-aiguilles tungstène TUC	205
CRILE , porte-aiguilles	187	DIETRICH-HEGEMANN , ciseaux vasculaires	114
CRILE-MURRAY , porte-aiguilles	182	Dilatateurs vasculaires	313, 314
CRILE-RANKIN , pinces hémostatiques	17	Dilatateurs vasculaires	72, 313, 314
CRILE-WOOD , porte-aiguilles	182	DINGMANN , daviers à cartilage	453
CRILE-WOOD , porte-aiguilles tungstène TUC	196	DIPLOMAT , tensiomètre à mercure	379
CRILE-WOOD-BABY , porte-aiguilles	182	DISSECTION , micro-ciseaux	145, 147
CRILE-WOOD-BABY , porte-aiguilles tungstène TUC	196	DIXON-LOVELACE , pinces hémostatiques	26
Crochets très fins	242-250	DOUGLAS , pinces à épiler les cils	76
CULLEN-WERTHEIM , pinces à hystérectomie	44	DOUGLAS , trocars	330
Curettes	434-441		

	Page		Page
DOUGLAS-BOZEMANN , pinces à tampons	233	FARREL , porte-coton	311
DOYEN , ciseaux	106	FAULKNER , pinces à tenir de cristallins	90
DOYEN , écarteurs	267	FAURE , pinces à hystérectomie	45
DOYEN , écarteurs abdominaux	302	FAURE , pinces-clamps pour le peritoine	50
DOYEN , marteaux	428	FAVALORO , ciseaux vasculaires	115
DOYEN , pinces à champs	51	FEHLAND , pinces-clamps stomacales e pour l'intestin	527
DOYEN , pinces-clamps stomacales et pour l'intestin	520, 524	FEILCHENFELD , pinces à échardes	73
DOYEN , pinces-clamps stomacales et pour l'intestin Atrauma	524	FEIN , porte-coton	312
DOYEN , porte-aiguilles	180	FERGUSSON , canules d'aspiration	335
DOYEN , rugines-raspatoires	445	FERGUSSON , ciseaux à chirurgie	104
DOYEN , sondes	310	FERGUSSON , daviers porte-os	455
DOYEN-STILLE , écarteurs	266	FERGUSSON , pinces-clamps à pression progressive	47
DUBOIS , ciseaux à gynécologie	107	FERREIRA , écarteurs avec illumination a lumière froide	280
DUEHRSEN , pinces à dissection	64	FERRIS-SMITH , pinces à griffes	65
DUNHILL , pinces hémostatiques	22	FERROZELL , sondes conductrices	222
DUPLAY , pinces à pansements	236	FIBRE OPTIC , Fibre Optic laryngoscopes	360
DUPLEX-LIGHTWEIGHT/BABY , stéthoscopes	378	FINOCCHIETTO , ciseaux	118
DURANTE , pinces pour saisir les tissus	68	FINOCCHIETTO , pinces-clamps pour pédicules rénaux	37
DUVAL , pinces pour saisir les tissus	68	FINOCCHIETTO , porte-aiguilles	185
DUVAL , pinces pour saisir l'intestin	519	FINOCCHIETTO , porte-aiguilles tungstène TUC	197
DUVAL-COLLIN , pinces pour saisir les tissus	66	FINSEN , écarteurs autostatiques	283
Dynamomètre	374	FISCHER-ARLT , pinces à iris	80
DYNAMOMETRE III , instruments pour mesurer	374	FLAGG , précelles (brucelles) pour coton	96
E		FLETCHER , pinces à éponges	232
		FOERSTER , pinces à iris	81
EASTMAN-RICHARDSON , écarteurs	264	FOERSTER-BALLENGER , pinces à éponges	237
EATON-BECKMANN , écarteurs autostatiques	293	FOMON , ciseaux à dissection	111
Écarteurs	242-308	FOMON , ciseaux nasaux	119
Écarteurs abdominaux	298-307	FOREGGER (WISCONSIN) , Fibre Optic laryngoscopes	358
Écarteurs autostatiques	283, 284, 287-297	FOREGGER (WISCONSIN) , laryngoscopes	354
Écarteurs avec illumination à lumière froide	281	FOX , curettes tranchantes	436
Écarteurs de la chirurgie de la main	285	FOX-GOLDMAN (SPECIAL) , ciseaux à gencives	136
Écarteurs fins	250	FOX-GOLDMAN , ciseaux à gencives	136
Écarteurs optique pour endoscope	281, 282	FOX-GOLDMAN , ciseaux tungstène TUC	161
Écarteurs pour appareils plâtrés	320	FRANKENFELDT , pinces pour saisir	316
Écarteurs pour le genou	466	FRANZ , écarteurs abdominaux	302
Écarteurs pour parties molles	255, 256	FRAZIER , canules d'aspiration	335
Écarteurs pour ramus	257	FRAZIER , crochets très fins	242
Écarteurs spinaux	250	FREER , élévateurs	448
ECHLIN , pinces-gouges	474	FRENCH-EYE/Ryder , porte-aiguilles tungstène TUC	193
Éclaireurs frontaux	368	FRIEDMAN , pinces-gouges	468
ECONOM , trousse à diagnostic	380	FRIEDRICH , instrument pour la suture	223
Ecraseurs et pinces-clamps pour l'intestin et l'estomac	530	FRICTSCH , écarteurs	266
EICKEN , trocarts	330	FRYKHOLM , pinces-gouges	474
EICKEN-CLAUS , aiguilles à ligatures	219	FUCHS-GILL , pinces à iris	83
EICKEN-KILLIAN , canules d'aspiration	335	FULTON , ciseaux vasculaires	117
EISELSBERG , ciseaux à ligatures	128	G	
Élévateurs	447-449, 481	GARRETT , dilataateurs vasculaires	313
ELSCHNIG , pinces à fixer	84	GEISSENDOERFER-OVERHOLT , pinces à dissection et à ligatures	23
ENGEL , scie à main pour appareils plâtrés	318	GELPI , écarteurs autostatiques	294
ENGL. MODELL , pinces à champs	51	GEMINI , pinces à dissection et à ligatures	35
ERHARDT , pinces à entropion	88	GERALD , pinces à dissection et à griffes	62
ESMARCH , ciseaux pour pansements	134	GERSTER , daviers à os	394
ESMARCH , couteaux pour appareils plâtrés	318	GERSTER-LOWMAN , daviers à os	394
Etriers à extension	399, 400	GILL , pinces capsulaires	83
EUFRATE-PASQUÉ , porte-aiguilles tungstène TUC	193	GILL-FUCHS , pinces à iris	83
EWALD , pinces à dissection et à griffes	60	GILL-HESS , pinces à iris	82
EXCENTRIC-LISTER , ciseaux pour pansements	133	GILLIES , crochets très fins	242
F		GILLIES , pinces à dissection tungstène TUC	92
		GILLIES , pinces à griffes	67
FALK , aiguilles à ligatures	219	GILLIES , porte-aiguilles	185
FARABEUF , daviers porte-os	458	GILLIES , porte-aiguilles tungstène TUC	198
FARABEUF , écarteurs	278	GILLS-WELSH , ciseaux pour capsulotomie	140
FARABEUF , rugines-raspatoires	443	GIL-VERNET , écarteurs fins	249
FARABEUF-LAMBOTTE , daviers porte-os	458	GOELET , écarteurs	279
		GOLDMAN-FOX (SPECIAL) , ciseaux à gencives	136
		GOLDMAN-FOX , ciseaux à gencives	136

	Page		Page
GOLDMAN-FOX , ciseaux tungstène TUC	161	HOHMANN , leviers à os	396, 397
Goniomètres	373	HOKE , ostéotomes	417
GOOD , ciseaux pour les amygdales	119	HOLINGER , laryngoscopes	362
GOOD-SCHWECKENDICK , ciseaux pour les amygdales	119	HOPKINS , couteaux pour appareils plâtrés	318
GORNEY , ciseaux à dissection	111	HOPKINS-JOHNS , clamps bulldog	11
GOSSET , écarteurs abdominaux	298	HOPKINS-JOHNS , pinces à dissection et à ligatures	32
GRADLE , pinces à épiler les cils	76	HOPKINS-JOHNS , pinces à poser	11
GRAEFE , ciseaux oculaires	126	HORNE-JOBSON , porte-coton	312
GRAEFE , crochets très fins	243	HÖSEL , porte-aiguilles	188
GRAEFE , pinces à fixer	84	HÖSEL , porte-aiguilles tungstène TUC	201
GRAEFE , pinces à iris	79	HOSPITAL-PROVIDENCE , pinces hémostatiques	16
GRAY , pinces-clamps pour voies biliaires	40	HRYNTSCHAK-YOUNG , porte-aiguilles	189
GRAZIL , ciseaux à chirurgie	103	HUDSON , perforateurs à main	387
GREEN , pinces à fixer	84	HUMBY , dermatome	176
GREEN-SENN , écarteurs fins	247	HUNT , pinces	70
GROSS-MAIER , pinces à pansements	230, 231	HUNTER , pinces à échardes	73
GRUENWALD (JANSEN) , pinces nasales	78	HURD , aiguilles à ligatures	218
GRUENWALD , pinces nasales	78		
GUTHRIE , crochets très fins	246	I	
GUYON , pinces-clamps pour pédicules rénaux	38, 39	Instrumentation pour les clous de Küntscher	488, 489
GUYON-ARTRAUMATIC , pinces-clamps pour pédicules rénaux	39	Instruments à écorcher les tendons	465
		Instruments à noeuds	223
H		Instruments pour mesurer	371-375
HABERER , spatules abdominaux	308	Instruments pour saisir les tendons	464
HAJEK , marteaux	429	Instruments sensibilités	376
HALLE , ciseaux nasaux	120	IOWA , aiguilles spéciales	345
HALSEY , porte-aiguilles	181	ISRAEL , écarteurs	253
HALSEY , porte-aiguilles tungstène TUC	195	IVES-FANSLER , sphinctérosopes	538
HALSTED , pinces hémostatiques	16	IWANSON , cercle	375
HALSTED-MOSQUITO , pinces hémostatiques	15		
HARMAN-BISHOP , pinces à iris	82	J	
HARMS , pinces pour sutures	86	JACKSON , laryngoscopes à Lumière foide	363
HARRINGTON , écarteurs	267	JACKSON , pinces à pansements	78
HARRISON (PYE-SMITH) , pinces à stérilisation	564	JACOBI , aiguilles à ligatures	217
HARTMANN , pinces hémostatiques	14	JACOBS CHUCK , perforateurs à main	388
HARTMANN , pinces-gouges	469	JACOBSON , micro-porte-aiguilles	210
HARVEY , ciseaux pour fils	130	JACOBSON , micro-porte-aiguilles tungstène TUC	204
HATFIELD , curettes tranchantes	439	JACOBSON , porte-aiguilles	182
HEANEY , écarteurs	277	JACOBSON , porte-aiguilles tungstène TUC	194
HEANEY , pinces à hystérectomie	43	JAMESON , pied à coulisse	372
HEANEY , porte-aiguilles	184	JAMESON , pinces musculaires	87
HEANEY-BALLANTINE , pinces à hystérectomie	43	JAMESON , porte-aiguilles	184
HEANEY-KANTER , pinces à hystérectomie	43	JANET , seringues	348
HEANEY-REZAK , pinces à hystérectomie	44	JANSEN (GRUENWALD) , pinces nasales	78
HEATH , ciseaux à ligatures	129	JANSEN , curettes tranchantes	440
HEATH-RICHTER , pinces pour agrafes	224	JANSEN , écarteurs autostatiques	284
HEGAR-OLSEN , porte-aiguilles	185	JANSEN , pinces nasales	77
HEGAR-OLSEN , porte-aiguilles tungstène TUC	198	JAPAN-TOHOKU , pinces à champs	52
HEGEMANN-DIETHRICH , ciseaux vasculaires	114	JEWELER , pinces à dissection tungstène TUC	92
HEGENBARTH , pinces pour agrafes	224	JOBSON-HORNE , porte-coton	312
HEIFETZ , pinces	70	JOHANSSON , trocars	329
HEISS , pinces-clamps à bronches	30	JOHNS-HOPKINS , clamps bulldog	11
HELPERICH-BIER , scies à amputation	384	JOHNS-HOPKINS , pinces à dissection et à ligatures	32
HEMINGWAY , curettes tranchantes	441	JOHNS-HOPKINS , pinces à poser	11
HENAHAN , crochet à dent de sagesse	481	JONES , pinces à champs	51
HENLEY , écarteurs autostatiques	288	JOSEPH , ciseaux à dissection	112
HENNIG , pinces écartante pour appareils plâtrés	319	JOSEPH , crochets très fins	246
HERRICK , pinces-clamps pour pédicules rénaux	39	JUDD-ALLIS , pinces pour saisir le tissu et l'intestin	518
HESS , pinces à iris	81		
HESSBERG , aiguilles à ligatures	217	K	
HESS-GILL , pinces à iris	82	KADER , écarteurs	273
HEYMANN , ciseaux nasaux	120	KALT , micro-porte-aiguilles	212
HEYWOOD-SMITH , pinces à éponges	236	KALT , micro-porte-aiguilles tungstène TUC	205
HIBBS , ciseaux-burins	420	KALT-ARRUGA , micro-porte-aiguilles	212
HIBBS , ostéotomes	420		
HIRSCHMANN , anuscopes	539		
HOEN , élévateurs	448		
HOESEL , écarteurs	265		

	Page		Page
KALT-CASTROVIEJO , micro-porte-aiguilles	212	Lampes à alcool	556
KANTER-HEANEY , pinces à hystérectomie	43	LANDAU , trocars	329
KANTROWITZ , pinces à dissection et à ligatures	35	LANDAU-SEGOND , pinces à hystérectomie	45
KAPLAN-CRANE , pinces pour cul-de-sac	98	LANDGRAF , précelles (brucelles) pour coton	97
KATZIN , ciseaux corneales	142	LANDOLT , ciseaux fins	124
KATZIN-BARRAQUER , ciseaux corneales	142	LANE , daviers porte-os	457
KAYE , ciseaux pour Face-lift	161	LANE , pinces à champs	51
KELLY (RICHARDSON) , écarteurs	264	LANE , pinces à griffes	61
KELLY , ciseaux pour fistules	106	LANE , pinces-clamps stomacales	531
KELLY , ciseaux tungstène TUC	153	LANE , tournevis	491
KELLY , écarteurs	268	LANGÉ , ciseaux pour pansements	132
KELLY , pinces à éponges	235	LANGÉ , pinces pour agrafes	225
KELLY , pinces hémostatiques	17	LANGÉ-HOHMANN , leviers à os	397
KELLY , proctoscopes	540, 541	LANGENBECK , couteaux à amputation	172
KELLY-RANKIN , pinces hémostatiques	17	LANGENBECK , daviers porte-os	455
KELMAN-McPHERSON , pinces pour sutures	85	LANGENBECK , écarteurs	254, 258
KERN , daviers porte-os	456	LANGENBECK , élévateurs	447
KERSTING , pince à anastomose	528	LANGENBECK , porte-aiguilles	188
KILNER (RAGNELL) , ciseaux à dissection	112	LANGENBECK , porte-aiguilles tungstène TUC	202
KILNER , crochets très fins	242	LANGENBECK , rugines-raspatoires	443
KILNER , porte-aiguilles	181	LANGENBECK , scies à résection	384
KILNER , porte-aiguilles tungstène TUC	195	LANGENBECK-DELICATE , porte-aiguilles tungstène TUC	202
KIRBY , pinces à iris	82	LANGENBECK-KOCHER , écarteurs	259
KIRSCHNER , broches	499-502	LANGENBECK-MINI , écarteurs fins	247
KIRSCHNER , canules d'aspiration	503	LANGENBECK-PARKER , écarteurs	278
KIRSCHNER , écarteurs abdominaux	303	LANGENBECK-RYDER , porte-aiguilles tungstène TUC	202
KIRSCHNER , étriers à extension	400	Laryngoscopes	353-360
KIRSCHNER , sondes conductrices	222	Laryngoscopes à lumière froide	357-360
KIRSCHNER-FERROZELL , sondes conductrices	222	LAWRENCE , pinces à dissection et à ligatures	34
KLEINERT-KUTZ , crochets très fins	242	LEKSELL-STILLE , pinces-gouges	473
KLEINERT-KUTZ , instruments pour saisir les tendons	464	LEMPERT , pinces-gouges	470
KLEINERT-KUTZ , pinces-gouges	471	LERICHE , pinces hémostatiques	16
KLIMA-ROSSEGER , aiguilles à biopsie	343	LESTER , pinces à fixer	84
KLINIKUM BERLIN , presses-tube	53	Leviers à os	395-398
KLINKENBERGH-LOTH , ciseaux vasculaires	117	LEWIN , daviers porte-os	454
KNAPP , crochets très fins	246	LEXER , ciseaux à dissection	111
KNIGHTON , écarteurs autostatiques	297	LEXER , ciseaux tungstène TUC	158
KNOWLES , ciseaux pour pansements	133	LEXER , ciseaux-burins	422, 423
KOCHER , aiguilles à ligatures	216	LEXER , ostéotomes	422, 423
KOCHER , écarteurs	251, 260, 266	LEXER-BABY , ciseaux à dissection	111
KOCHER , pinces-clamps stomacales e pour l'intestin	522, 525	LICHTENBERG , porte-aiguilles	187
KOCHER , pinces-clamps stomacales e pour l'intestin Atrauma	525	LICHTENBERG , porte-aiguilles tungstène TUC	201
KOCHER , sondes conductrices	222	LICHTWITZ , trocars	330
KOCHER-DELICATE , pinces hémostatiques	22	Ligateurs hémoïroides	552-554
KOCHER-LANGENBECK , écarteurs	259	LIGHTWEIGHT-DUPLEX/BABY , stéthoscopes	378
KOCHER-OCHSNER , pinces hémostatiques	20, 21	Limes à ongles	579
KOERTE , écarteurs	252, 267	Limes à os	450
KÖNIG , ciseaux pour ongles incarnés	135	LINCOLN , ciseaux vasculaires	117
KÖNIG , sondes conductrices	221	LINDEMANN , scies à résection	384
KRAUSE , trocars	330	LISTER , ciseaux pour pansements	133, 134
KROENLEIN , pinces à saisir	13	LISTER , ciseaux tungstène TUC	162
KRONECKER , aiguilles à ligatures	218	LISTER , pinces à tampons	228
KUEHNE , pinces porte-lamelles	78	LISTER-EXCENTRIC , ciseaux pour pansements	133
KÜNTSCHER , clous centromédullaires	492-494	LISTON , couteaux à amputation	172
KÜNTSCHER , instrumentation pour les clous	488, 489	LISTON , pinces coupantes à os	477, 480
KUTZ-KLEINERT , crochets très fins	242	LISTON-KEY , pinces coupantes à os	479
		LITTAUER , ciseaux à ligatures	128
L		LITTAUER , pinces à épiler les cils	76
LA GRANGE , ciseaux oculaires	126	LITTAUER , pinces à ongle	569
LAHEY , écarteurs	263	LITTAUER-LISTON , pinces coupantes à os	477
LAHEY , pinces-clamps pour voies biliaires	37	LITTLE , écarteurs	263
LAMBOTTE , daviers porte-os	460	LITTLER , ciseaux fins	123
LAMBOTTE , ostéotomes	426	LITTLEWOOD , pinces pour saisir le tissu et l'intestin	518
LAMBOTTE , rugines-raspatoires	443	LLOYD-DAVIS , pince à anastomose	529
Lames de bistouris	167, 168	LOCKHART-MUMMERY , sondes	311
Lames de rasoir	177	LOCKLIN , ciseaux à gencives	136
Lames pour scies électriques	323	LOCKLIN , ciseaux tungstène TUC	162
LAMPERT , pinces à chalazion	89	LOCKWOOD , pinces pour saisir le tissu et l'intestin	518
		LOCKWOOD-ALLIS , pinces pour saisir le tissu et l'intestin	518

	Page		Page
LONDON COLLEGE , précelles (Brucelles) pour coton	95	MC INDOE , ciseaux	118
LONG , pinces à hystérectomie	44	MC INDOE , pinces à dissection	60
LORENZ , ciseaux pour pansements	133	MC INDOE , pinces coupantes à os	478
LORNA , pinces à champs	52	MC INTOSH , Fibre Optic laryngoscopes	357
LOTH-KLINKENBERGH , ciseaux vasculaires	117	MC INTOSH , laryngoscopes	353
LOTH-SCHOEMAKER , ciseaux à ligatures	128	McDONALD , éleveurs	448
LOUTE , tendeurs serre-fils	407	McDONALD , pinces à capsulorhexis	90
LOVELACE-DIXON , pinces hémostatiques	26	McPHERSON , pinces pour sutures	85
LOWER , pinces-clamps pour voies biliaires	37	McPHERSON-KELMAN , pinces pour sutures	85
LUCAE , marteaux	430	MEAD , marteaux	430
LUCAE , pinces nasales	77	MEAD , pinces-gouges	469
LUCAS , ciseaux-burins	417	MEEKER , pinces à dissection et à ligatures	25
LUCAS , curettes tranchantes	441	MENGHINI , aiguilles à biopsie	344
LUER , canules d'aspiration	336	MERIAM , précelles (brucelles) pour coton	96
LUER , pinces-clamps à hémorroïdes, atrauma	48	Mesures graduées	556, 559
LUER , pinces-gouges	469	METZENBAUM , ciseaux à dissection	108
LUETHY-BECK , porte-aiguilles tungstène TUC	202	METZENBAUM , ciseaux tungstène TUC	155, 156
M		METZENBAUM , porte-aiguilles tungstène TUC	199
MAGILL , pinces pour sondes	360	METZENBAUM-BABY , ciseaux à dissection	108
MAIER-GROSS , pinces à pansements	230, 231	METZENBAUM-DELICATE , ciseaux à dissection	110
MAIER-SIMS , pinces à pansements	239	METZENBAUM-DELICATE , ciseaux tungstène TUC	158-160
Manches en plomb	482	METZENBAUM-NELSON , ciseaux à dissection	109
Manches pour bistouris	165-167	MEYERDING , écarteurs	273
Manches pour canules de liposuction et infiltration	338, 340	MEYERDING , écarteurs autostatiques	294
MARKHAM-MEYERDING , écarteurs autostatiques	294	MEYERDING , écarteurs fins	247
MARKWALDER , pinces coupantes à os	477	MEYERDING-MARKHAM , écarteurs autostatiques	294
MARQUARDT , pinces-gouges	470	MICHEL , agrafes	225
Marqueur pour Facelift	376	MICHEL , pinces pour agrafes	224
Marteaux	427-433	MICRO-ADSON , pinces à dissection et à griffes	59
Marteaux-percuteurs	369, 370	Micro-ciseaux	143-149
MARTEL , pinces hémostatiques pour le cuir chevelu	12	MICRO-FRIEDMAN , pinces-gouges	476
MARTEL-WILLET , pinces hémostatiques pour le cuir chevelu	12	MICRO-MOSQUITO , pinces hémostatiques	15
MARTIN , daviers à cartilage	453	Micro-pinces	71, 72
MARTIN , écarteurs	262	Micro-porte-aiguilles	204-213
MARTIN-CARTILAGE , ciseaux	118	Micro-porte-aiguilles à manches rondes	206-209
MARTINI , curettes tranchantes	440	Micro-porte-aiguilles tungstène TUC	204, 205
MASS.-GENERAL-HOSPITAL (M.G.H.) , porte-aiguilles	183	MICRO-RYDER , porte-aiguilles tungstène TUC	193
MASSE-ROBIN , écarteurs abdominaux	306	MICROVASCULAR , porte-aiguilles tungstène TUC	193
MASSON , porte-aiguilles	184	MICRO-WULLSTEIN , canules d'aspiration	335
MASSON , porte-aiguilles tungstène TUC	197	MIDDELDORPF , écarteurs	264
MATHIEU , écarteurs	278	MIKULICZ , écarteurs	268
MATHIEU , porte-aiguilles	186	MIKULICZ , pinces-clamps pour le péritoine	49
MATHIEU , porte-aiguilles tungstène TUC	199	MIKULICZ-BABY , pinces-clamps pour le péritoine	49
MATHIEU , spéculums rectaux	536	MILLER , Fibre Optic laryngoscopes	359
MATHIEU-DELICATE , porte-aiguilles	186	MILLER , laryngoscopes	355
MATHIEU-DELICATE , porte-aiguilles tungstène TUC	199	MILLER , pinces pour papier à articulat	98
MATHIEU-RYDER VASCULAR , porte-aiguilles tungstène TUC	200	MILLER-SENN , écarteurs fins	250
MATHIEU-RYDER , porte-aiguilles tungstène TUC	200	MILLER-SENN-BABY , écarteurs fins	250
MATSON , rugines-raspatoires	446	MILLIGAN , écarteurs autostatiques	288
MAYFIELD , pinces-gouges	470	MILLS , ciseaux vasculaires	116
MAYO ROBSON , pinces-clamps stomacales e pour l'intestin Atrauma	526	MINI , lames de bistouris	167
MAYO , ciseaux	105	MINI , manches de bistouris	167
MAYO , ciseaux tungstène TUC	153	MINI-FRIEDMAN , pinces-gouges	468
MAYO , clips de stérilisation	564	MINI-HOHMANN , leviers à os	395
MAYO-ADAMS , écarteurs autostatiques	296	MINI-LAMBOTTE , ostéotomes	426
MAYO-HARRINGTON , ciseaux	105	MINI-LANGENBECK , écarteurs fins	247
MAYO-HEGAR , porte-aiguilles	184	MINI-LEXER , ciseaux-burins	422
MAYO-HEGAR , porte-aiguilles tungstène TUC	192	MINI-LEXER , ostéotomes	422
MAYO-HEGAR-DELICATE , porte-aiguilles	184	Miroirs frontaux	367
MAYO-HEGAR-DELICATE , porte-aiguilles tungstène TUC	192	MISKIMON , écarteurs autostatiques	289
MAYO-NOBLE , ciseaux	105	MIXTER , ciseaux à chirurgie	104
MAYO-ROBSON , pinces-clamps stomacales et pour l'intestin	521, 526	MIXTER , pinces à dissection et à ligatures	33, 34
MAYO-RUSS. , pinces pour saisir les tissus	66	MIXTER-BABY , pinces à dissection et à ligatures	33
MAYO-STILLE , ciseaux	105	MIXTER-O'SHAUGNESSY , pinces à dissection et à ligatures	33
MAYO-STILLE , ciseaux tungstène TUC	154	MIXTER-OVERHOLT , pinces à dissection et à ligatures	29
MC GIVNEY , ligateurs hémorroïdes	553	MOD. BONN , ciseaux fins	124
		MOD. BONN , pinces à iris	81
		MOD. BONN , pinces pour sutures	86
		MOD. TÜBINGEN , pinces pour sutures	86

	Page		Page
MOD. USA , ciseaux pour le cordon ombilical	121	OVERHOLT-BABY , pinces à dissection et à ligatures	23
MOD. WIEN , instruments pour la suture	223	OVERHOLT-GEISSENDOERFER , pinces à dissection et à ligatures	23
MODELL TÜBINGEN , écarteurs	262	OVERHOLT-MIXTER , pinces à dissection et à ligatures	29
MODELL TÜBINGEN , écarteurs autostatiques	296		
MODELL USA , pinces à dissection et à griffes	59	P	
MODELL USA , pinces écartantes pour appareils plâtrés	319	PALMER , clous à os	496
MOELTGEN , goniomètre	373	Pansements	318-324
MOLDESTAD , crochets très fins	244	PARAMETRIUM , ciseaux tungstène TUC	154
MOLLISON , écarteurs autostatiques	289	PARAMETRIUM , pinces-clamps pour parametrium	46
MOLT , rugines-raspatoires	444	PARKER , écarteurs	278
MOORE , perforateurs à main	387	PARKER-LANGENBECK , écarteurs	278
MOORFIELD , pinces pour sutures	84	PARTSCH , ciseaux-burins	418
MORGAN , anusscopes	541	PARTSCH , marteaux	430
MORGAN , luce fredda	541	PATON , micro-porte-aiguilles	212
MORRIS , écarteurs	261	PAUFIQUE , pinces pour sutures	86
MOSQUITO-HALSTED , pinces hémostatiques	15	PAYR , pinces-clamps et écraseurs	530
MOSQUITO-MICRO , pinces hémostatiques	15	PAYR , sondes conductrices	221
MOYNIHAN , pinces à hystérectomie	44	PAYR-BABY , pinces-clamps et écraseurs	530
Multiple approach retractor	282	PAYR-SCHMIEDEN , sondes conductrices	221
MUMMERY-LOCKHART , sondes	311	PEAN , pinces à saisir	13
MYRTLE LEAF , sondes	310	PEAN-DELICATE , pinces hémostatiques	22
		PEAN-ROCHESTER , pinces hémostatiques	18, 19
N		PEERS , pinces à champs	52
NABATOFF , trousse à varices	312	PEET , pinces à échardes	75
NAGER , aiguilles à ligatures	219	PELKMANN , pinces à tampons	235
NEFF , bistouris à ménisques	467	PENNINGTON , pinces à saisir	13
NEGUS , pinces-clamps pour voies biliaires	40	PERCY , retracteur pour amputation	463
NEIVERT , porte-aiguilles	181	Perforateurs à main	385-390
NEIVERT , porte-aiguilles tungstène TUC	195	PERRY , précelles (brucelles) pour coton	97
NELATON , sondes	310	PERTHES , perforateurs à main	390
NELSON , pinces pour saisir les tissus	66	PHANEUF , pinces à hystérectomie	45
NELSON , trocars	328	PHILIPS , tournevis	491
NELSON-METZENBAUM , ciseaux à dissection	109	PIERCE , trocars	330
NERVE , micro-ciseaux	147	PIFFARD , curettes tranchantes	436
NEUMANN , ciseaux à gencives	137	Pilons	451
NEW ORLEANS , porte-aiguilles	183	PINARD , Stéthoscopes	377
NEW ORLEANS , porte-aiguilles tungstène TUC	194	Pince-guide pour perforateurs	390
NIRO , pinces à fil	401	Pinces à anastomose	528, 529, 532, 533
NOBLE-MAYO , ciseaux	105	Pinces à capsulorhexis	90
nopa PROFI , scie à autopsie	484	Pinces à chalazion	88, 89
NORTHBENT , ciseaux à ligatures	129	Pinces à champs	51, 52
NOTO , pinces à éponges	234	Pinces à compresses	51, 52
NOYES , ciseaux à iridectomie	138	Pinces à dissection	23-25, 29, 31-36, 57-65
NUSSBAUM , pinces-clamps stomacales et pour l'intestin	523	Pinces à dissection tungstène TUC	92-94
		Pinces à échardes	73-75
O		Pinces à entropion	88
O'BRIAN , ciseaux fins	124	Pinces à épiler les cils	76
OBWEGESER , écarteurs pour parties molles	255, 256	Pinces à éponges	228-239
OBWEGESER , écarteurs pour ramus	257	Pinces à fil	401-403, 405, 406
OCHSNER , trocars	329	Pinces à fixer	84
OCHSNER-KOCHER , pinces hémostatiques	20, 21	Pinces à griffes	57-65, 67, 68
O'CONNOR , crochets très fins	243	Pinces à hystérectomie	41-45
O'CONNOR-O'SULLIVAN , écarteurs abdominaux	301	Pinces à iris	79-82
OEHLER , oubces à dissection tungstène TUC	92	Pinces à ligatures	23-25, 29, 31-36
OLIVECRONA , ciseaux vasculaires	117	Pinces à ligatures avec plate-forme	71, 72
OLLIER , écarteurs	253	Pinces à ongle	568-570
OLSEN-HEGAR , porte-aiguilles	185	Pinces à pansements	78, 229-239
OLSEN-HEGAR , porte-aiguilles tungstène TUC	198	Pinces à poser	11
OLSEN-HEGAR-USA , porte-aiguilles tungstène TUC	198	Pinces à saisir	12, 13, 316
OMBREDANNE , marteaux	427	Pinces à stérilisation	564
OSCINOPA , scie à autopsie	483	Pinces à tampons	229-239
OSCINOPA , scie électrique pour appareils plâtrés	321	Pinces à tenir de cristallins	90
O'SHAUGNESSY-MIXTER , pinces à dissection et à ligatures	33	Pinces à torsader le fil tungstène TUC	203
Ostéotomes	417-426	Pinces atrauma	91
O'SULLIVAN-O'CONNOR , écarteurs abdominaux	301	Pinces auriculaires	29,77
OTOSKOP UNI , trousse à diagnostic	381	Pinces capsulaires	83
OVERHOLT , pinces à disséquer et à ligatures	24	Pinces coupantes à os	477-480
		Pinces de reposition	487

	Page		Page
Pincés de suture	97	Proctoscopes	537-543
Pincés d'horloger	69	PROVIDENCE-HOSPITAL , pincés hémostatiques	16
Pincés écartantes pour appareils plâtrés	319	PUTTI , râpes	451
Pincés emporte-pièces à biopsie rectale	551	PYE-SMITH (HARRISON) , pincés à stérilisation	564
Pincés hémostatiques	9-53	PYNCHON-ANDREWS , canules d'aspiration	331
Pincés hémostatiques fines	15	Q	
Pincés hémostatiques graciles	22	QUINBY , ciseaux à gencives	137
Pincés hémostatiques pour amygdales	27	QUINKE , aiguilles à biopsie	344
Pincés hémostatiques pour le cuir chevelu	12, 26	R	
Pincés micro	71, 72	RABINER , marteaux-percuteurs	369
Pincés musculaires	87, 88	Raccords	349
Pincés nasales	77, 78	RADOLF , pince à ongle	482
Pincés plates	404	RAGNELL (KILNER) , ciseaux à dissection	112
Pincés porte-lamelles	78	RAGNELL-DAVIS , écarteurs fins	250
Pincés pour agrafes	224, 225	RALK , perforateurs à main	389
Pincés pour cul-de-sac	98	RALK , pincés à échardes	75
Pincés pour la chambre antérieure	85	RAMPLEY , pincés à éponges	238
Pincés pour papier à articulat	98	RANKIN-CRILE , pincés hémostatiques	17
Pincés pour saisir le tissu	9, 517, 518	RANKIN-KELLY , pincés hémostatiques	17
Pincés pour saisir les tissus	9, 66-68, 70, 316	Râpes	451
Pincés pour saisir l'intestin	9, 517-519	Récipients cylindriques	562
Pincés pour sondes	360	Rectoscopes	544-550
Pincés pour suture	85, 86	REHN , couteaux à transplantation	175
Pincés vasculaire	12	REILL , micro-porte-aiguilles	207
Pincés-clamps à anastomose	532, 533	REINER , couteaux pour appareils plâtrés	318
Pincés-clamps à bronches	30	RESANO , pincés-clamps stomacales et pour l'intestin	527
Pincés-clamps à hémorroïdes	47, 48	Retracteur pour amputation	463
Pincés-clamps à hémorroïdes, atrauma	48	REVERDIN , aiguilles	214
Pincés-clamps à pression progressive	47, 48	REVERDIN , spatules abdominales	308
Pincés-clamps et écraseurs pour l'intestin et l'estomac	530	REYNOLDS , ciseaux à dissection	112
Pincés-clamps intestinales	532, 533	REZAK-HEANEY , pincés à hystérectomie	44
Pincés-clamps pour le péritoine	49, 50	RIBBON , ciseaux oculaires	127
Pincés-clamps pour l'intestin et stomacales	520-523	RICARD , écarteurs abdominaux	306
Pincés-clamps pour parametrium	46	RICHARDSON (KELLY) , écarteurs	264
Pincés-clamps pour pédicules rénaux	37-39	RICHARDSON-EASTMAN , écarteurs	264
Pincés-clamps pour voies biliaires	37, 40	RICHTER , ciseaux à chirurgie	104
Pincés-clamps stomacales e pour l'intestin Atrauma	524-527	RICHTER-HEATH , pincés pour agrafes	224
Pincés-clamps stomacales et pour l'intestin	520-523	RIGHBY , écarteurs autostatiques	295
Pincés-gouges	468-476	RIRAP , stéthoscopes	378
Pincettes pour casser les lames	177	RISCOPE S , troussees ophthalmologiques	381
Pistolet laveur	590, 591	RISCOPE S , troussees oto-/ophthalmologiques	380
Plaquettes en carbure de tungstène	190, 191	ROBERTS , pincés-clamps à bronches	30
Plateaux pour instruments	561	Robinets	349
PLESTER , canules d'aspiration	335	ROBIN-MASSE , écarteurs abdominaux	306
PLESTER , écarteurs autostatiques	295	ROCHESTER-CARMALT , pincés hémostatiques	27
Ponction	327-349	ROCHESTER-PEAN , pincés hémostatiques	18, 19
POOLE , canules d'aspiration	332	ROEDER , pincés à champs	52
POOLE-BABY , canules d'aspiration	332	ROETTGEN-RUSKIN , pincés-gouges	473
Porte-aiguilles	180-213	ROGGE , pincés à stérilisation	564
Porte-aiguilles tungstène TUC	192-205	ROLLET , crochets très fins	246
Porte-coton	311, 312	ROSCHKE , anuscopes	537
Porte-ligature	223	ROSSEGGER-KLIMA , aiguilles à biopsie	343
POTTS-DE MARTEL , ciseaux vasculaires	116	ROTTER , aiguilles à ligatures	219
POTTS-SMITH , ciseaux	118	ROUX , écarteurs	277
POTTS-SMITH , ciseaux tungstène TUC	157	ROWE , pincés de reposition	487
POTTS-SMITH , ciseaux vasculaires	113, 115	RUDD , ligateurs hémorroïdes	554
POTTS-SMITH , micro-porte-aiguilles	212	Rugines-Raspatoires	442-446
POTTS-SMITH , micro-porte-aiguilles tungstène TUC	205	RUMEL , pincés à dissection et à ligatures	31
POTTS-SMITH , pincés à dissection et à griffes	63	RUSKIN , pincés-gouges	471, 475
POTTS-SMITH , pincés à dissection tungstène TUC	92	RUSKIN-LISTON , pincés coupantes à os	478
PRATT , pincés-clamps à hémorroïdes	47	RUSKIN-MINI , pincés-gouges	471
PRATT , sonde fistulaire	311	RUSS. MODELL , pincés pour saisir les tissus	68
PRATT , spéculums rectaux	536	RUSS.-MAYO , pincés pour saisir les tissus	66
Précélles pour coton	95-97	RYDER MICRO , porte-aiguilles tungstène TUC	193
PRECISA , tensiomètre à mercure	379	RYDER/FRENCH EYE , porte-aiguilles tungstène TUC	193
PRESBYTERIAN , presses-tube	53		
Presses-tube	53		
PRINCE , ciseaux pour les amygdales	119		
PRINCE , pincés musculaires	87		

	Page		Page
RYDER-LANGENBECK , porte-aiguilles tungstène TUC	202	SIMON , bistouris à fistules	174
RYDER-MATHIEU VASCULAR , porte-aiguilles tungstène TUC	200	SIMON , écarteurs	262
RYDER-MATHIEU , porte-aiguilles tungstène TUC	200	SIMS , ciseaux à gynécologie	107
S		SIMS , ciseaux tungstène TUC	155
SALAH , aiguilles à biopsie	343	SIMS , spéculums rectaux	534
SALENIUS , bistouris à ménisques	467	SIMS-MAIER , pinces à pansements	239
SAMII , pinces	70	SINGLEY-TUTTLE , pinces pour saisir les tissus	66
SANVENERO , ciseaux à dissection	112	SINUSCOPY , trocars	327
SAROT , pinces-clamps à bronches	30	SMILLIE , bistouris à ménisques	467
SAROT , porte-aiguilles	183	SMILLIE , écarteurs pour le genou	466
SAROT , porte-aiguilles tungstène TUC	197	SMITH (MOD. USA) , ciseaux pour pansements	133
SATINSKY , ciseaux vasculaires	117	SMITH , ciseaux pour fils	130
SATTERLEE , scies à amputation	384	SMITH-BUIE , spéculums rectaux	536
SATTLER , pinces musculaires	87	SMITH-FERRIS , pinces à griffes	65
SAUERBRUCH , écarteurs	260, 274	SMITH-HEYWOODS , pinces à éponges	236
SAUERBRUCH , pinces-gouges	474	SMITH-PETERSEN , ciseaux-burins	419
SAWTELL-SCHNIDT , pinces hémostatiques pour amygdales	27	SMITH-PETERSEN , ostéotomes	419
SAWYER , spéculums rectaux	534	SMITH-PETERSON , pinces-gouges	475
SCALP-CONTOUR , écarteurs autostatiques	294	SMITH-POTTS , ciseaux	118
SCHAEDEL , pinces à champs	51	SMITH-POTTS , ciseaux vasculaires	113, 115
SCHANZ , broches	503	SMITH-POTTS , micro-porte-aiguilles	212
SCHUDE , curettes tranchantes	435	SMITH-POTTS , micro-porte-aiguilles tungstène TUC	205
SCHINDLER , pinces-clamps pour le péritoine	50	SMITH-POTTS , pinces à dissection et à griffes	63
SCHINK , dermatome	176	SNELLEN , pinces à entropion	88
SCHMID , aiguilles spéciales	345	SNITMAN , écarteurs autostatiques	284
SCHMIEDEN , aiguilles à ligatures	217	Soins des pieds	568-579
SCHMIEDEN-PAYR , sondes conductrices	221	Sondes	310, 311
SCHMIEDEN-TAYLOR , ciseaux vasculaires	116	Sondes conductrices	220-222
SCHNIDT-SAWTELL , pinces hémostatiques pour amygdales	27	Spatules abdominales	308
SCHOEMAKER , ciseaux à goitre	119	Spéculums rectaux	534-536
SCHOEMAKER-LOTH , ciseaux à ligatures	128	SPENCER , ciseaux à ligatures	128
SCHUHKNECHT , écarteurs autostatiques	289	SPENCER-DELICATE , ciseaux à ligatures	128
SCHUKNECHT , ciseaux pour fils	130	SPENCER-WELLS , pinces hémostatiques	14
SCHULZE-BERGMANN , spéculums rectaux	535	Sphinctérosopes	537-541
SCHUMACHER , ciseaux pour le cordon ombilical	121	SPRATT , curettes tranchantes	435
SCHWECKENDICK-GOOD , ciseaux pour les amygdales	119	ST. MARKS , écarteurs	275
Scie à autopsie	483-485	ST. MARTIN , pinces pour sutures	85
Scie à main pour appareils plâtrés	318	STACKE , sondes	310
Scie électrique pour appareils plâtrés	321, 322	STADLER-BRAUN , ciseaux à épisiotomie	121
Scies	384, 483-485	STANDARD CLAR , éclairateurs frontaux	368
Scies à amputation et résection	384	STANDARD , ciseaux à chirurgie	102
Scies à résection et amputation	384	STANDARD , ciseaux à gencives	137
Scies pour bagues	482	STANDARD , ciseaux tungstène TUC	152, 153
SCUDDER , pinces-clamps stomacales et pour l'intestin	523, 526	STANDARD , pinces à dissection	57
SCUDDER , pinces-clamps stomacales et pour l'intestin Atrauma	526	STANDARD , pinces à griffes	57
SEBILEAU , élévateurs	447	STANDARD , trocars	327
SEDILLOT , rugines-raspatoires	445	STEINBACH , marteaux	432
SEGOND , pinces à hystérectomie	45	STEINMANN , clous	399, 497, 498
SEGOND-LANDAU , pinces à hystérectomie	45	STEINMANN , instruments pour saisir les tendons	464
SELLORS-CRAFOORD , pinces auriculaires	29	STELLBRINK , pinces-gouges	468
SEMB , daviers porte-os	456	STERNUM , pinces à fil TUC	403
SEMB , pinces coupantes à os	480	STERNUM , pinces à torsader le fil tungstène TUC	203
SEMB , pinces-gouges	472	Stéthoscopes	377, 378
SEMB , rugines-raspatoires	446	STEVENS , ciseaux à ténotomie	126
SEMKEN , pinces à dissection et à griffes	60, 61	STEVENS , ciseaux tungstène TUC	161
SEMKEN , pinces à dissection tungstène TUC	92	STEVENS , micro-porte-aiguilles	212
SEMM , écarteurs abdominaux	303	STEVENS , pinces à iris	80
SENN-GREEN , écarteurs fins	247	STIEGLITZ , pinces à échardes	75
SENNING (SCHWED. MODELL) , porte-aiguilles	183	STILLE , cisailles pour appareils plâtrés	320
SENNING (SCHWED. MODELL) , porte-aiguilles tungstène TUC	194	STILLE , ciseaux-burins	421
SENN-MILLER , écarteurs fins	250	STILLE , ostéotomes	421
SENN-MILLER-BABY , écarteurs fins	250	STILLE , perforateurs à main	386
Seringues	348	STILLE , pinces à dissection et à griffes	65
Seringues à ampoule	347	STILLE , pinces-clamps pour pédicules rénaux	38
SEUTIN , ciseaux pour pansements	134	STILLE , pinces-gouges	472
SHORTBENT , ciseaux à ligatures	129	STILLE-BARRAYA , pinces à griffes	65
SIEBOLD , ciseaux à gynécologie	107	STILLE-DOYEN , écarteurs	266
		STILLE-LISTON , pinces coupantes à os	479
		STILLE-LUER , pinces-gouges	473

	Page		Page
STILLE-MAYO , ciseaux	105	ULRICH , pinces à pansements	229
STILLE-MAYO , ciseaux tungstène TUC	154	UNI OTOSKOP , trousse à diagnostic	381
STILLE-RUSKIN , pinces-gouges	472	UNIVERSAL , ciseaux pour fils	130
STILLE-SHERMAN , perforateurs à main	385	UNIVERSAL , ciseaux pour pansements	132
STRATTE , porte-aiguilles	185	UNIVERSAL , ciseaux tungstène TUC	162
STRATTE , porte-aiguilles tungstène TUC	197	UNIVERSAL , perforateurs à main	389
STRAUSS , rectoscope	548	UNIVERSAL , pinces-gouges	468
STRULLY , ciseaux vasculaires	115	UNIVERSAL , trocars	327
SULLIVAN (BROPHY) , ciseaux fins	123	US-TPYE BALFOUR , écarteurs abdominaux	299
SULLIVAN , ciseaux à gencives	137		
Super Cut ciseaux SC	101	V	
Suture	180-225	VACUNOPA , vacuum cleaner	324
SYME , aiguilles à ligatures	216	VAN BUREN , daviers porte-os	452
T		VANNAS MOD. TÜBINGEN , ciseaux pour le cataracte secondaire	139
TAYLOR , écarteurs spinaux	250	VANNAS , ciseaux pour le cataracte secondaire	139
TAYLOR , leviers à os	398	VERBRUGGE , daviers porte-os	459
TAYLOR , marteaux-percuteurs	369	VERNET-GIL , écarteurs fins	249
TAYLOR , pinces à dissection et à griffes	61	VERNIER , calibres	372, 373
TAYLOR-CUSHING , pinces à dissection tungstène TUC	93	VERRES , aiguilles spéciales	345
TAYLOR-SCHMIEDEN , ciseaux vasculaires	116	VIRCHOW , couteaux à cerveaux	173
Tendeurs sére-fils	407	Vis d'ostéo-synthèse	505-512
Tensiomètre à mercure	379	WISE , pinces à ligatures avec plate-forme	71
TERRIER , pinces hémostatiques	14	VOLKMANN , curettes tranchantes	434, 440
TERSON , pinces capsulaires	83	VOLKMANN , écarteurs	251, 252
THIERSCH , couteaux à transplantation	175	W	
THIESS , marteaux	430	WACHENFELDT , pinces pour agrafes	224
THOMS-ALLIS , pinces pour saisir le tissu et l'intestin	518	WAGNER , ciseaux fins à chirurgie	122
THOREK , ciseaux à dissection	111	WALB , couteaux à autopsie	173
THORPE , calibres	372	WALDMANN , ciseaux à épisiotomie	121
Tire-veines	315	WALTER , écarteurs	250
TOENNIS , ciseaux vasculaires	116	WALTER-CARMALT , pinces à échardes	73
TOENNIS , pinces à dissection et à ligatures	36	WALTON , ciseaux fins	124
TOENNIS , porte-aiguilles	188	WALTON , écarteurs autostatiques	297
TOENNIS , porte-aiguilles tungstène TUC	201	WALTON , pinces à pansements	239
TOENNIS-ADSON , ciseaux vasculaires	116	WALTON , scies pour bagues	482
TOENNIS-ADSON-DELICATE , ciseaux tungstène TUC	161	WALTON-LISTON , pinces coupantes à os	478
TOHOKU-JAPAN , pinces à champs	52	WALTON-YANKAUER , canules d'aspiration	331
Tords-fil	223	WANGENSTEEN , pinces à dissection	65
Tournevis	491	WANGENSTEEN , pinces à dissection tungstène TUC	94
TOWNLEY , calibres	372	WANGENSTEEN , porte-aiguilles	185
TRAVERS , écarteurs autostatiques	288	WANGENSTEEN , porte-aiguilles tungstène TUC	197
TRELAT , aiguilles à ligatures	218	WANGENSTEEN-DELICATE , porte-aiguilles	185
Tréphines pour appareils plâtrés	318	WARTENBERG , instruments sensibilités	376
TROCAR , aiguilles à biopsie	344	WATSON , dermatome	176
Trocarts	327-330	WAUGH , pinces pour saisir les tissus	67
TROELTSCH (WILDE) , pinces auriculaires	77	WEBSTER , porte-aiguilles	181
TROEMNER , marteaux-percuteurs	370	WEBSTER , porte-aiguilles tungstène TUC	195
Trousse à varices	312	WECKER , ciseaux à iridectomie	138
Trousses à diagnostic	380, 381	WEITLANER , écarteurs autostatiques	287
TROUTMAN (CORNEAL) , pinces à iris	82	WEITLANER-BABY , écarteurs autostatiques	287
TROUTMAN , ciseaux cornéales	141	WELLS-SPENCER , pinces hémostatiques	14
TROUTMAN , micro-porte-aiguilles	207	WERTHEIM , ciseaux	106
TROUTMAN-BARRAQUER , micro-porte-aiguilles	206	WERTHEIM , pinces à hystérectomie	41, 42
TROUTMAN-CHRIS , pincettes pour casser les lames	177	WERTHEIM , porte-aiguilles	185
TÜBINGER MODELL , écarteurs	262	WERTHEIM , porte-aiguilles tungstène TUC	198
TUDOR-EDWARDS , pinces coupantes à os	479	WERTHEIM-CULLEN , pinces à hystérectomie	44
TUFFIER , écarteurs	267	WESTCOTT , ciseaux à ténatomie	140
TUFFIER , pinces à saisir	12	WESTCOTT , micro-ciseaux	143
TUFFIER , spatules abdominales	308	WESTERMARK , pinces à tampons	232
TUOHY , aiguilles à biopsie	344	WIGMORE , couteaux pour appareils plâtrés	318
TURNBULL , pinces à ongles	568	WIKSTROEM , pinces à dissection et à ligatures	41
TUTTLE-SINGLEY , pinces pour saisir les tissus	66	WILDBERG , agrafes	496
U		WILDE (TROELTSCH) , pinces auriculaires	77
UCKERMANN , porte-coton	312	WILLET-MARTEL , pinces hémostatiques pour le cuir chevelu	12
ULRICH , daviers porte-os	462	WILLIAMS , pinces pour saisir le tissu et l'intestin	518
		WILLIGER , curettes tranchantes	440

WILLIGER , élévateurs	447
WILLIGER , marteaux	428
WILLIGER , rugines-raspatoirs	444
WILMER , ciseaux oculaires	126
WISCONSIN (FOREGGER) , Fibre Optic laryngoscopes	358
WISCONSIN (FOREGGER) , laryngoscopes	354
WOLFF , écarteurs pour appareils plâtrés	320
WULLSTEIN MICRO , canules d'aspiration	335
WULLSTEIN , écarteurs autostatiques	289

Y

YANCOSKIE , écarteurs pour abdominoplastie	280
YANKAUER , canules d'aspiration	331
YANKAUER-WALTON , canules d'aspiration	331
YEOMAN , pinces emporte-pièces à biopsie rectale	551
YOUNG-HYRYNTSCHAK , porte-aiguilles	189

Z

ZAUFAL-JANSEN , pinces-gouges	471
ZENKER , écarteurs	272
ZENKER , pinces à dissection et à ligatures	32
ZIEGLER , pinces à épiler les cils	76
ZWEIFEL , porte-aiguilles	187
ZWEIFEL , porte-aiguilles tungstène TUC	202

Indice alfabetico

	Pagina		Pagina
A		B	
Accessori per chiodi centromidollari con gancio	490	BABCOCK , pinze per afferrare l'intestino	9, 519
Accessori per power drills	392	BABINSKY , martelli percussori	369
Accu power drill	391	BABY KOCHER , pinze stomacali e intestinali Atrauma	526
Accumulatore / Caricabatteria per power drills	393	BABY-ADSON , pinze emostatiche	25
ADAMS-MAYO , divaricatori autostatici	296	BABY-BALFOUR , divaricatori addominali	299
ADISON , pinza di protezione	390	BABY-COLLIN , divaricatori addominali	304
ADLERKREUTZ , pinze anatomiche e chirurgiche	65	BABY-CRILE-WOOD , portaghi	182
ADSON , cannule per aspirazione	335	BABY-CRILE-WOOD , portaghi tungsteno TUC	196
ADSON , divaricatori autostatici	290, 291	BABY-DOYEN , pinze stomacali e intestinali	520
ADSON , elevatori	449	BABY-KOCHER , pinze stomacali e intestinali	521, 526
ADSON , pinze anatomiche e chirurgiche	59, 60	BABY-LEXER , forbici per preparazioni	111
ADSON , pinze emostatiche	25	BABY-METZENBAUM , forbici per preparazioni	108
ADSON , pinze tungsteno TUC	93	BABY-MIKULICZ , pinze per peritoneo	49
ADSON , portaghi	183	BABY-MIXTER , pinze per preparazioni e legature	33
ADSON-ANDERSON , divaricatori autostatici	290	BABY-OVERHOLT , pinze per preparazioni e legature	23
ADSON-BABY , divaricatori autostatici	292	BABY-POOLE , cannule per aspirazione	332
ADSON-BABY , pinze emostatiche	25	BABY-SENN-MILLER , divaricatori pottili	250
ADSON-BECKMANN , divaricatori autostatici	293	BABY-WEITLANER , divaricatori autostatici	287
ADSON-BROWN , pinze anatomiche e chirurgiche	60	Bacinella per soluzioni	562
ADSON-MICRO , pinze anatomiche e chirurgiche	59	Bacinella rotonda	559
ADSON-TOENNIS , forbici	116	Bacinelle	559, 561, 562
ADSON-TOENNIS-DELICATE , forbici tungsteno TUC	161	Bacinelle per strumenti	561
ADVENTITIA , micro forbici	145, 147	Bacinelle reniformi	559
Aghi di Réverdin	214	BACKHAUS , pinze per fissare le compresse (Fissatele)	52
Aghi per biopsia	343, 344	BACON , pinze-sgorbie	470
Aghi per introduzione	346	BAINBRIDGE , pinze emostatiche	27
Aghi per legatura	215-219	BAINBRIDGE , pinze stomacali e intestinali Atrauma	524
Aghi speciali	345	BALFOUR US-TYPE , divaricatori addominali	299
Agrafes	225	BALFOUR , divaricatori addominali	299, 300
Air power drill	391	BALFOUR-BABY , divaricatori addominali	299
ALAN PARKS , anoscopi	537	BALL & SOCKET , pinze per fissare le compresse (Fissatele)	52
ALDERDYCE , elevatori	448	BALLANTINE-HEANEY , pinze per isterectomia	43
Alesatore per viti per ossa	513	BALLENGER-FOERSTER , pinze per spugne	237
ALEXANDER , periostotomi	446	BARRAQUER , forbici per iridectomia	138
ALEXANDER , scalpelli	418	BARRAQUER , micro-portaghi	206
Allarga gessi	319	BARRAQUER , pinze depilatorie	76
ALLIS , pinze per afferrare tessuti	9	BARRAQUER , pinze per la camera anteriore	85
ALLIS , pinze per afferrare tessuti e l'intestino	517	BARRAQUER-KATZIN (COLIBRI) , pinze per iride	82
ALLIS-ADAIR , pinze per afferrare tessuti e l'intestino	517	BARRAQUER-KATZIN , forbici per cornea	142
ALLIS-BABY , pinze per afferrare tessuti e l'intestino	517	BARRAQUER-TROUTMAN , micro-portaghi	206
ALM , divaricatori autostatici	283	BARRAYA-STILLE , pinze anatomiche e chirurgiche	65
ALY , strumenti per sensibilità	376	BAUMGARTNER , portaghi	184
ANDERSON-ADSON , divaricatori autostatici	290	BECK-LUETHY , portaghi tungsteno TUC	202
ANDREWS-PYNCHON , cannule per aspirazione	331	BECKMANN , divaricatori autostatici	292
Anestesia	353-363	BECKMANN-ADSON , divaricatori autostatici	293
Anoscopi	537-543	BECKMANN-EATON , divaricatori autostatici	293
ANVIL , tronchesine per unghie	571	BEEBEE , forbici per corone	130, 131
Archi per estensione	399, 400	BEER , pinze depilatorie	76
ARLT-FISCHER , pinze per iride	80	BEESON , allarga gessi	319
ARRUGA , micro-portaghi	212	Bendaggi	318-324
ARRUGA , pinze capsulare	83	BENGOLEA , pinze emostatiche	28
ARRUGA , portaghi	180	BENSAUDE , anoscopi	540
ARRUGA , portaghi tungsteno TUC	201	BERENS , pinze muscolare	88
ARRUGA-KALT , micro-portaghi	212	BERGMANN , forbici per bendaggi	132
Artroscopia	408-415	BERGMANN , martelli	427
Astucci per diagnostica	380, 381	BERGMANN , seghe per apparecchi gessati	318
Astuccio per varici	312	BERKE , pinze per calazio	89
AUSTIN , pinze per legature	71	BERLINER , martelli percussori	370
AUSTRALIA , divaricatori	283	BERNHARD , pinze per fissare le compresse (Fissatele)	51
AUSTRALIA , divaricatori per la chirurgia della mano	285	BEYER , pinze-sgorbie	471
AYER , pinze per calazio	88	Bicchieri graduati	556, 559
		BILLROTH , divaricatori	252
		BINKHORST , pinze capsulare	83

BIRCHER , meniscotomi	467	CARDIOPHON , stetoscopi	378
BIRCHER-GANSKE , tenaglie per ossa	453	CARMALT-ROCHESTER , pinze emostatiche	27
BIRKETT , pinze per preparazioni e legature	41	CARMALT-WALTER , pinze per schegge	73
BISHOP-HARMAN , pinze per iride	82	CAROLL , goniometro	373
Bisturi	165-177	CAROLL , strumenti per afferrare tendini	464
Bisturi per ascessi	174	CARREL , pinze emostatiche	14
Bisturi per fistole	174	CARROLL , portaghi	182
Bisturi per interventi	169-171	CARROLL , portaghi tungsteno TUC	194
BLASCOVICS , pinze muscolare	87	CARTILAGE-MARTIN , forbici	118
BLOND , anoscopi	542, 543	CASTROVIEJO , circolo	375
BLOUNT , divaricatori per il ginocchio	466	CASTROVIEJO , forbici per cornea	141
BLOUNT , elevatori per ossa	398	CASTROVIEJO , forbici per iridectomia	138
BLUEPOWER , segna elettrica per gesso	322	CASTROVIEJO , micro-portaghi	210, 213
BLUMENTHAL , pinze-sgorbie	469	CASTROVIEJO , micro-portaghi tungsteno TUC	204, 205
BÖHLER , archi per estensione	399	CASTROVIEJO , pinza capsulare	83
BÖHLER , pinze-sgorbie	471	CASTROVIEJO , pinze fissatrice	84
BOLEY , calibratore	373	CASTROVIEJO , pinze per rompere la lamette	177
BONACCOLTO , pinze per sutura	85	CASTROVIEJO , pinze per sutura	85
BONNEY , pinze per afferrare tessuti	68	CASTROVIEJO-EPKER , circolo	375
BONNEY , pinze tungsteno TUC	94	CASTROVIEJO-KALT , micro-portaghi	212
BOOMERANG , portaghi	189	CATLIN , coltelli per amputazione	172
BÖTTCHER , forbici per tonsille	119	Cesioio per gesso	319
BOYNTON , portaghi	180	Cesoie per ossa	477-480
BOYNTON , portaghi tungsteno TUC	201	CHADWICK , forbici oftalmologiche	126
BOYS-ALLIS , pinze per afferrare tessuti e l'intestino	518	CHAPUT , pinze per afferrare	12
BOZEMANN , pinze per tamponi	233	CHARRIERE , seghe per amputazione	384
BOZEMANN , portaghi	182	CHEATLE , pinze per sterilizzazione	564
BOZEMANN , portaghi tungsteno TUC	197	CHERON , pinze per polipi	234
BOZEMANN , strumenti per legatura	223	CHILDE , pinze per agrafes	225
BOZEMANN-DOUGLAS , pinze per tamponi	233	Chiodi	492-498
BRAND , strumenti per afferrare tendini	464	Chiodi per ossa	492-498
BRAUN-STADLER , forbici per episiotomia	121	Chiodo a gancio	495
BRIDGE , pinze per preparazioni e legature	34	CHRIS-TROUTMAN , pinze per rompere le lamette	177
BRODIE , sonde	311	CHURCH , forbici	117
BROPHY (SULLIVAN) , forbici fine	123	CLAR 55 , lampade frontali	368
BROPHY , pinze anatomiche e chirurgiche	63	CLAR STANDARD , lampade frontali	368
BROWN , pinze anatomiche e chirurgiche	64	CLASSON , forbici	117
BROWN , portaghi	183	CLAUS , aghi per legatura	218
BROWN-ADSON , pinze anatomiche e chirurgiche	60	CLAUS-EICKEN , aghi per legatura	219
BROWNE-DENIS , divaricatori addominali	301	CLEVELAND , cesoie per ossa	478
BRUNNER , aghi per legatura	216, 217	CLEVELAND , pinze-sgorbie	468
BRUNNER , divaricatori	263	CLEVELAND-GARDNER , cesoie per ossa	477
BRUNNER , pinze stomacali e intestinali	520	CLOWARD HIBBS SPRATT , curette taglienti	437
BRUNNER , sonde conduttrice	220	COAKLEY , trequarti	330
BRUNNER-FERROZELL , sonde conduttrice	222	COBB , curette taglienti	439
BRUNS , curette taglienti	434, 437	COBB , elevatori	449
BRUNS , forbici per apparecchi gessati	134	COBB , scalpelli	424
BRYANT , pinze per spugne	228	COGSWELL , cannule per aspirazione	336
BUCK , forbici per legatura	129	COLIBRI (BARRAQUER-KATZIN) , pinze per iride	82
BUCK , martelli percussori	369	COLLEGE-LONDON , pinze per cotone	95
BUELAU , trequarti	328	COLLER , pinze emostatiche	17
BULLDOG , pinze	10, 11	COLLIER , portaghi	180
BUNNELL , perforatori a mano	388	COLLIN , bisturi per interventi	170
BUNNELL , scollatendini	465	COLLIN , coltelli per amputazione	172
BUSCH , forbici ombelicale	121	COLLIN , dinamometri	374
BYRD , cannule per aspirazione	332	COLLIN , divaricatori addominali	304, 305
		COLLIN , manici per bisturi	166
C		COLLIN , martelli	429
CAIRNS , pinze emostatiche	22	COLLIN , pinze per afferrare	13
Calibratori	372, 373	COLLIN , pinze per agrafes	224
CAMPBELL , trequarti	328	COLLIN , pinze per polipi	234
Cannule di liposuzione e infiltrazione	339, 341, 342	COLLIN-BABY , divaricatori addominali	304
Cannule per aspirazione	331-337	COLLIN-DUVAL , pinze per afferrare tessuti	66
CANNY RYALL , divaricatori	279	COLLIN-HARTMANN , divaricatori	277
Canule per aspirazione	503	Coltelli per amputazione	172
CAPLAN , forbici nasale	119	Coltelli per apparecchi gessati	318
CARDINALE , forbici per ginecologia	107	Coltelli per autopsia	173
CARDINALE , forbici tungsteno TUC	155	Coltelli per cervello	173
		Coltelli per trapianti	175

	Pagina		Pagina
CONE , divaricatori autostatici	292	DERF , portaghi tungsteno TUC	195
CONVERSE , portaghi tungsteno TUC	195	DERF-CONVERSE , portaghi Dermatomo	180 176
CONVERSE-DERF , portaghi	180	DESCHAMPS , aghi per legatura	215
COOLEY , cannule per aspirazione	333	DESJARDINS , pinze per vie biliari	40
COOLEY , dilatatori per vasi	313	DESMARRES , divaricatori sottili	248
COOPER , aghi per legatura	216	DESMARRES , pinze per calazio Diagnostica	88 367-382
CORNEAL (TROUTMAN) , pinze per iride	82	DICK , pinze per anastomosi	528
CORWIN , pinze per ritorcere TUC	203	DIEFFENBACH , bisturi per ascessi	174
CORWIN , tenaglie TUC per fili	403	DIEFFENBACH , bisturi per interventi	170, 171
CORYLLOS , divaricatori	274	DIEFFENBACH , pinze bulldog	11
COTTLE KAZANJIAN , cesoie per ossa	477	DIETHRICH , micro-portaghi tungsteno TUC	205
COTTLE , forbici nasale	120	DIETHRICH-HEGEMANN , forbici per chirurgia vascolare	114
COTTLE , martelli	428	Dilatatori per vasi	72, 313, 314
COTTLE , pinze nasale	77	Dinamometro	374
COUPLAND , cannule per aspirazione	337	DINGMANN , pinze per afferrare cartilagine	453
CRAFOORD , forbici	118	DIPLOMAT , sfigmomanometro a mercurio	379
CRAFOORD , pinze per bronchi	30	DISSECTION , micro forbici	145, 147
CRAFOORD-SELLORS , pinze auricolari	29	Divaricatori	242-308
CRANLE-CAPLAN , pinze per marcazione	98	Divaricatori addominali	298-307
CREGO , elevatori per ossa	398	Divaricatori autostatici	283, 284, 287-297
CRILE , pinze emostatiche	17	Divaricatori ottico per endoscopi	281, 282
CRILE , portaghi	187	Divaricatori per il ginocchio	466
CRILE-MURRAY , portaghi	182	Divaricatori per la chirurgia della mano	285
CRILE-RANKIN , pinze emostatiche	17	Divaricatori per ramo	257
CRILE-WOOD , portaghi	182	Divaricatori per tessuti molli	255, 256
CRILE-WOOD , portaghi tungsteno TUC	196	Divaricatori sottili	242-250
CRILE-WOOD-BABY , portaghi	182	Divaricatori spinali	250
CRILE-WOOD-BABY , portaghi tungsteno TUC	196	Divaricatori universale	282
CULLEN-WERTHEIM , pinze per isterectomia	44	Divaricatori von illuminazione a luce fredda	281
Curette	434-441	DIXON-LOVELACE , pinze emostatiche	26
Curette taglianti	434-441	DOUGLAS , pinze depilatorie	76
CUSHING , divaricatori sottili	244, 248	DOUGLAS , trequarti	330
CUSHING , divaricatori spinali	250	DOUGLAS-BOZEMANN , pinze per tamponi	233
CUSHING , perforatori a mano	387	DOYEN , divaricatori	267
CUSHING , pinze anatomiche e chirurgiche	62	DOYEN , divaricatori addominali	302
CUSHING , pinze tungsteno TUC	93	DOYEN , forbici	106
CUSHING-TAYLOR , pinze tungsteno TUC	93	DOYEN , martelli	428
CZERNY , divaricatori	279	DOYEN , periostotomi	445
CZERNY , specoli rettali	534	DOYEN , pinze per fissare le compresse (Fissatele)	51
D		DOYEN , pinze stomacali e intestinali	520, 524
DAHMEN , osteotomi	425	DOYEN , pinze stomacali e intestinali Atrauma	524
DAHMEN , scalpelli	425	DOYEN , portaghi	180
DANDY , forbici	115	DOYEN , sonde	310
DANDY , pinze per il cuoio capelluto	26	DOYEN-STILLE , divaricatori	266
DARLING , divaricatori autostatici	295	DUBOIS , forbici per ginecologia	107
DAVIDSON , divaricatori	276	DUEHRSSSEN , pinze anatomiche e chirurgiche	64
DAVIS-RAGNELL , divaricatori sottili	250	DUNHILL , pinze emostatiche	22
DE BAKEY , cannule per aspirazione	331	DUPLAY , pinze per polipi	236
DE BAKEY , dilatatori per vasi	314	DUPLEX-LIGHTWEIGHT/BABY , stetoscopi	378
DE BAKEY , forbici per chirurgia vascolare	113, 116	DURANTE , pinze per afferrare tessuti	68
DE BAKEY , forbici tungsteno TUC	157	DUVAL , pinze per afferrare l'intestino	519
DE BAKEY , pinze atrauma	91	DUVAL , pinze per afferrare tessuti	68
DE BAKEY , pinze tungsteno TUC	94	DUVAL-COLLIN , pinze per afferrare tessuti	66
DE BAKEY , portaghi tungsteno TUC	192	DYNAMOMETER III	374
DE LA ROZA , aghi per legatura	217	E	
DE MARTEL-POTTS , forbici	116	EASTMAN-RICHARDSON , divaricatori	264
DE MARTEL-WOLFSON , pinze intestinali	532, 533	EATON-BECKMANN , divaricatori autostatici	293
DE MARTEL-WOLFSON , pinze per anastomosi	532, 533	ECHLIN , pinze-sgorbie	474
DEAN , forbici per gengiva	136	ECONOM , astucci per diagnostica	380
DEAN , forbici tungsteno TUC	162	EICKEN , trequarti	330
DEAN-DELICATE , forbici per gengiva	136	EICKEN-CLAUS , aghi per legatura	219
DEAVER , divaricatori	269-271	EICKEN-KILLIAN , cannule per aspirazione	335
DEAVER , forbici per chirurgia	104	EISELSBERG , forbici per legatura	128
DEJERINE , martelli percussori	370	Elevatori	447-449, 481
DEMEL , strumenti tendi fili	407	Elevatori per ossa	395-398
DENIS-BROWNE , divaricatori addominali	301		
DERF , portaghi	180		

ELSCHNIG , pinze fissatrice	84
ENGEL , seghe per apparecchi gessati	318
ENGL. MODELL , pinze per fissare le compresse (Fissatele)	51
ERHARDT , pinze per entropio	88
ESMARCH , coltelli per apparecchi gessati	318
ESMARCH , forbici per bendaggi	134
EUFRATE-PASQUE , portaghi tungsteno TUC	193
EWALD , pinze anatomiche e chirurgiche	60

F

FALK , aghi per legatura	219
FARABEUF , divaricatori	278
FARABEUF , periostotomi	443
FARABEUF , tenaglie per ossa	458
FARABEUF-LAMBOTTE , tenaglie per ossa	458
FARRELL , portacotone	311
FAULKNER , pinze per tenere il cristallino	90
FAURE , pinze per isterectomia	45
FAURE , pinze per peritoneo	50
FAVALORO , forbici	115
FEHLAND , pinze stomacali e intestinali	527
FEILCHENFELD , pinze per schegge	73
FEIN , portacotone	312
FERGUSON , cannule per aspirazione	335
FERGUSON , forbici per chirurgia	104
FERGUSON , pinze per pressione progressiva	47
FERGUSON , tenaglie per ossa	455
FERREIRA , divaricatori con illuminazione a luce fredda	280
FERRIS-SMITH , pinze chirurgiche a denti di topo	65
FERROZELL , sonde conduttrice	222
FERROZELL-BRUNNER , sonde conduttrice	222
FIBRE OPTIC , Laringoscopi a luce fredda	360
Fili	499-502
FINOCCHIETTO , forbici	118
FINOCCHIETTO , pinze per peduncoli renali	37
FINOCCHIETTO , portaghi	185
FINOCCHIETTO , portaghi tungsteno TUC	197
FINSEN , divaricatori autostatici	283
FISCHER-ARLT , pinze per iride	80
Fissatele	51, 52
FLAGG , pinze per cotone	96
FLETCHER , pinze per spugne	232
FOERSTER , pinze per iride	81
FOERSTER-BALLENGER , pinze per spugne	237
FOMON , forbici nasale	119
FOMON , forbici per preparazioni	111
Forbici	102-162
Forbici addominali	106
Forbici coronaria	115
Forbici Face-lift	161
Forbici fine	122-124
Forbici micro	143-149
Forbici nasale	119, 120
Forbici oftalmologici	125-127, 138-143
Forbici ombelicale	121
Forbici per anatomia	118
Forbici per apparecchi gessati	134
Forbici per bendaggi	132-134
Forbici per capsulotomia	140
Forbici per cartilagini	118
Forbici per cataratta secondaria	139
Forbici per chirurgia	102-105, 122
Forbici per chirurgia vascolare	113-117
Forbici per cornea	141-143
Forbici per corone	130, 131
Forbici per episiotomia	118, 121
Forbici per filo metallico	130
Forbici per fistole	106

Forbici per gengiva	136, 137
Forbici per ginecologia	105-107
Forbici per gozzo	119
Forbici per incisioni	104
Forbici per iridectomia	125, 138
Forbici per legatura	128, 129
Forbici per lobectomia	118
Forbici per nervi	111
Forbici per neurochirurgia	115-117
Forbici per pelle	135
Forbici per preparazioni	108-112
Forbici per strabismo	126
Forbici per tenotomia	126, 140
Forbici per tonsille	119
Forbici per unghie	135
Forbici per unghie incarnate	135
Forbici Super-Cut SC	101
Forbici, tungsteno TUC	152-162
FOREGGER (WISCONSIN) FIBRE OPTIC , laringoscopi a luce fredda	358
FOREGGER (WISCONSIN) , laringoscopi	354
FOX , curette taglienti	436
FOX-GOLDMAN SPEZIAL , forbici per gengiva	136
FOX-GOLDMAN , forbici per gengiva	136
FOX-GOLDMAN , forbici tungsteno TUC	161
FRANKENFELDT , pinze per afferrare	316
FRANZ , divaricatori addominali	302
FRAZIER , cannule per aspirazione	335
FRAZIER , divaricatori sottili	242
FREER , elevatori	448
FRENCH-EYE-RYDER , portaghi tungsteno TUC	193
FRIEDMAN , pinze-sgorbie	468
FRIEDRICH , strumenti per legatura	223
FRICTSCH , divaricatori	266
FRYKHOLM , pinze-sgorbie	474
FUCHS-GILL , pinze per iride	83
FULTON , forbici	117

G

GARETT , dilatatori per vasi	313
GEISSENDOERFER-OVERHOLT , pinze per preparazioni e legatura	23
GELPI , divaricatori autostatici	294
GEMINI , pinze per preparazioni e legatura	35
GERALD , pinze anatomiche e chirurgiche	62
GERSTER , tenaglie per ossa	394
GERSTER-LOWMAN , tenaglie per ossa	394
GILL , pinze capsulare	83
GILL-FUCHS , pinze per iride	83
GILL-HESS , pinze per iride	82
GILLIES , divaricatori sottili	242
GILLIES , pinze chirurgiche a denti di topo	67
GILLIES , pinze tungsteno TUC	92
GILLIES , portaghi	185
GILLIES , portaghi tungsteno TUC	198
GILLS-WELSH , forbici per capsulotomia	140
GIL-VERNET , divaricatori sottili	249
Giravite	491
GOELET , divaricatori	279
GOLDMAN-FOX SPEZIAL , forbici per gengiva	136
GOLDMAN-FOX , forbici per gengiva	136
GOLDMAN-FOX , forbici tungsteno TUC	161
Goniometro	373
GOOD , forbici per tonsille	119
GOOD-SCHWECKENDICK , forbici per tonsille	119
GORNEY , forbici per preparazioni	111
GOSSET , divaricatori addominali	298
GRADLE , pinze depilatorie	76
GRAEFE , divaricatori sottili	243

	Pagina		Pagina
GRAEFE , forbici oftalmologiche	126	HORNE-JOBSON , portacotone	312
GRAEFE , pinze fissatrice	84	HÖSEL , portaghi	188
GRAEFE , pinze per iride	79	HÖSEL , portaghi tungsteno TUC	201
Grappas	496	HOSPITAL-PROVIDENCE , pinze emostatiche	16
GRAY , pinze per vie biliari	40	HRYNTSCHAK-YOUNG , portaghi boomerang	189
GRAZIL , forbici per chirurgia	103	HUDSON , perforatori a mano	387
GREEN , pinze fissatrice	84	HUNT , pinze	70
GREEN-SENN , divaricatori sottili	247	HUNTER , pinze per schegge	73
GROSS-MAIER , pinze per polipi	230, 231	HURD , aghi per legatura	218
GRUENWALD (JANSEN) , pinze nasale	78		
GRUENWALD , pinze nasale	78	I	
GUTHRIE , divaricatori sottili	246	IOWA , aghi speciali	345
GUYON , pinze per peduncoli renali	38, 39	ISRAEL , divaricatori	253
GUYON-ARTRAUMATIC , pinze per peduncoli renali	39	IVES-FANSLER , sfinteroscopi	538
H		IWANSON , circolo	375
HABERER , spatole addominali	308	J	
HAJEK , martelli	429	JACKSON , laringoscopi a luce fredda	363
HALLE , forbici nasale	120	JACKSON , pinze per medicature	78
HALSEY , portaghi	181	JACOBI , aghi per legatura	217
HALSEY , portaghi tungsteno TUC	195	JACOBS CHUCK , perforatori a mano	388
HALSTED , pinze emostatiche	16	JACOBSON , micro-portaghi	210
HALSTED-MOSQUITO , pinze emostatiche	15	JACOBSON , micro-portaghi tungsteno TUC	204
HARMAN-BISHOP , pinze per iride	82	JACOBSON , portaghi	182
HARMS , pinze per sutura	86	JACOBSON , portaghi tungsteno TUC	194
HARRINGTON , divaricatori	267	JAMESON , calibratore	372
HARRISON (PYE-SMITH) , pinze per sterilizzazione	564	JAMESON , pinze muscolare	87
HARTMANN , pinze emostatiche	14	JAMESON , portaghi	184
HARTMANN , pinze-sgorbie	469	JANET , siringhe	348
HARVEY , forbici per filo metallico	130	JANSEN (GRUENWALD) , pinze nasale	78
HATFIELD , curette taglienti	439	JANSEN , curette taglienti	440
HEANEY , divaricatori	277	JANSEN , divaricatori autostatici	284
HEANEY , pinze per isterectomia	43	JANSEN , pinze nasale	77
HEANEY , portaghi	184	JEWELER , pinze tungsteno TUC	92
HEANEY-BALLANTINE , pinze per isterectomia	43	JOBSON-HORNE , portacotone	312
HEANEY-KANTER , pinze per isterectomia	43	JOHANSSON , trequarti	329
HEANEY-REZAK , pinze per isterectomia	44	JOHNS-HOPKINS , pinze bulldog	11
HEATH , forbici per legatura	129	JOHNS-HOPKINS , pinze per posizionare	11
HEATH-RICHTER , pinze per agrafes	224	JOHNS-HOPKINS , pinze per preparazioni e legatura	32
HEGAR-OLSEN , portaghi	185	JONES , pinze per fissare le compresse (Fissatele)	51
HEGAR-OLSEN , portaghi tungsteno TUC	198	JOSEPH , divaricatori sottili	246
HEGEMANN-DIETRICH , forbici per chirurgia vascolare	114	JOSEPH , forbici per preparazioni	112
HEGENBARTH , pinze per agrafes	224	JUDD-ALLIS , pinze per afferrare tessuti e l'intestino	518
HEIFETZ , pinze	70		
HEISS , pinze emostatiche	30	K	
HELFERICH-BIER , seghe per amputazione	384	KADER , divaricatori	273
HEMINGWAY , curette taglienti	441	KALT , micro-portaghi	212
HENAHAN , uncino per dente del giudizio	481	KALT , micro-portaghi tungsteno TUC	205
HENLEY , divaricatori autostatici	288	KALT-ARRUGA , micro-portaghi	212
HENNIG , allarga gessi	319	KALT-CASTROVIEJO , micro-portaghi	212
HERRICK , pinze per peduncoli renali	39	KANTER-HEANEY , pinze per isterectomia	43
HESS , pinze per iride	81	KANTROWITZ , pinze per preparazioni e legature	35
HESSBERG , aghi per legatura	217	KATZIN , forbici per cornea	142
HESS-GILL , pinze per iride	82	KATZIN-BARRAQUER , forbici per cornea	142
HEYMANN , forbici nasale	120	KATZIN-BARRAQUER , pinze per iride	82
HEYWOOD-SMITH , pinze per spugne	236	KAYE , forbici Face-lift	161
HIBBS , osteotomi	420	KELLY (RICHARDSON) , divaricatori	264
HIBBS , scalpelli	420	KELLY , divaricatori	268
HIRSCHMANN , anoscopi	539	KELLY , forbici per fistole	106
HOEN , elevatori	448	KELLY , forbici tungsteno TUC	153
HOESEL , divaricatori	265	KELLY , pinze emostatiche	17
HOHMANN , elevatori per ossa	396, 397	KELLY , pinze per spugne	235
HOKE , osteotomi	417	KELLY , protoscopi	540, 541
HOLINGER , laringoscopi	362	KELLY-RANKIN , pinze emostatiche	17
HOPKINS , coltelli per apparecchi gessati	318	KELMAN-McPHERSON , pinze per sutura	85
HOPKINS-JOHNS , pinze bulldog	11	KERN , tenaglie per ossa	456
HOPKINS-JOHNS , pinze per posizionare	11		
HOPKINS-JOHNS , pinze per preparazioni e legatura	32		

KERSTING , pinze per anastomosi	528	LANGENBECK , elevatori	447
KILNER (RAGNELL) , forbici per preparazioni	112	LANGENBECK , periostotomi	443
KILNER , divaricatori sottili	242	LANGENBECK , portaghi	188
KILNER , portaghi	181	LANGENBECK , portaghi tungsteno TUC	202
KILNER , portaghi tungsteno TUC	195	LANGENBECK , seghe per resezione	384
KIRBY , pinze per iride	82	LANGENBECK , tenaglie per ossa	455
KIRSCHNER , archi per estensione	400	LANGENBECK-DELICATE , portaghi tungsteno TUC	202
KIRSCHNER , cannule per aspirazione	503	LANGENBECK-KOCHER , divaricatori	259
KIRSCHNER , divaricatori addominali	303	LANGENBECK-MINI , divaricatori sottili	247
KIRSCHNER , fili	499-502	LANGENBECK-PARKER , divaricatori	278
KIRSCHNER , sonde conduttrice	222	LANGENBECK-RYDER , portaghi tungsteno TUC	202
KIRSCHNER-FERROZELL , sonde conduttrice	222	Laringoscopi	353-360
KLEINERT-KUTZ , divaricatori sottili	242	Laringoscopi a luce fredda	357-360
KLEINERT-KUTZ , pinze-sgorbie	471	LAWRENCE , pinze per preparazioni e legature	34
KLEINERT-KUTZ , strumenti per afferrare tendini	464	Legatori emorroidali	552-554
KLIMA-ROSSEGGER , aghi per biopsia	343	LEKSELL-STILLE , pinze-sgorbie	473
KLINIKUM BERLIN , pinze serratubi	53	LEMPERT , pinze-sgorbie	470
KLINKENBERGH-LOTH , forbici	117	LERICHE , pinze emostatiche	16
KNAPP , divaricatori sottili	246	LESTER , pinze fissatrice	84
KNIGHTON , divaricatori autostatici	297	LEWIN , tenaglie per ossa	454
KNOWLES , forbici per bendaggi	133	LEXER , forbici per preparazioni	111
KOCHER , aghi per legatura	216	LEXER , forbici tungsteno TUC	158
KOCHER , divaricatori	260, 266	LEXER , osteotomi	422, 423
KOCHER , divaricatori	251, 260, 266	LEXER , scalpelli	422, 423
KOCHER , pinze stomacali e intestinali	522, 525	LEXER-BABY , forbici per preparazioni	111
KOCHER , pinze stomacali e intestinali Atrauma	525	LICHTENBERG , portaghi	187
KOCHER , sonde conduttrice	222	LICHTENBERG , portaghi tungsteno TUC	201
KOCHER-DELICATE , pinze emostatiche	22	LICHTWITZ , trequarti	330
KOCHER-LANGENBECK , divaricatori	259	LIGHTWEIGHT/BABY-DUPLEX , stetoscopi	378
KOCHER-OCHSNER , pinze emostatiche	20, 21	Lime per le unghie	579
KOERTE , divaricatori	252, 267	Lime per ossa	450
KÖNIG , forbici per unghie incarnate	135	LINCOLN , forbici	117
KÖNIG , sonde conduttrice	221	LINDEMANN , seghe per resezione	384
KRAUSE , trequarti	330	LISTER , forbici per bendaggi	133, 134
KROENLEIN , pinze per afferrare	13	LISTER , forbici tungsteno TUC	162
KRONECKER , aghi per legatura	218	LISTER , pinze per spugne	228
KUEHNE , pinze porta-lamelle	78	LISTER-EXCENTRIC , forbici per bendaggi	133
KÜNTSCHER , chiodi centromidollari	492-494	LISTON , cesoie per ossa	477, 480
KÜNTSCHER , strumenti per chiodi	488, 489	LISTON , coltelli per amputazione	172
KUTZ-KLEINERT , divaricatori sottile	242	LISTON-KEY , cesoie per ossa	479
		LITTAUER , forbici per legatura	128
L		LITTAUER , pinze depilatorie	76
LA GRANGE , forbici oftalmologiche	126	LITTAUER , tronchesine per unghie	569
LAHEY , divaricatori	263	LITTAUER-LISTON , cesoie per ossa	477
LAHEY , pinze per vie biliari	37	LITTLE , divaricatori	263
LAMBOTTE , osteotomi	426	LITTLER , forbici fini	123
LAMBOTTE , periostotomi	443	LITTLEWOOD , pinze per afferrare tessuti e l'intestino	518
LAMBOTTE , tenaglie per ossa	460	LLOYD-DAVIS , pinze per anastomosi	529
Lame per bisturi	167, 168	LOCKHART-MUMMERY , sonda	311
Lame per segna elettrica	323	LOCKLIN , forbici per gengiva	136
Lamette de barba	177	LOCKLIN , forbici tungsteno TUC	162
Lampade ad alcool	556	LOCKWOOD , pinze per afferrare tessuti e l'intestino	518
Lampade frontali	368	LOCKWOOD-ALLIS , pinze per afferrare tessuti e l'intestino	518
LAMPERT , pinze per calazio	89	LONDON-COLLEGE , pinze per cotone	95
LANDAU , trequarti	329	LONG , pinze per isterectomia	44
LANDAU-SEGOND , pinze per isterectomia	45	LORENZ , forbici per bendaggi	133
LANDGRAF , pinze per cotone	97	LORNA , pinze per fissare le compresse (Fissatele)	52
LANDOLT , forbici fine	124	LOTH-KLINKENBERGH , forbici	117
LANE , giravite	491	LOTH-SCHOEMAKER , forbici per legatura	128
LANE , pinze anatomiche e chirurgiche	61	LOUTE , strumenti tendi fili	407
LANE , pinze per fissare le compresse (Fissatele)	51	LOVELACE-DIXON , pinze emostatiche	26
LANE , pinze stomacali	531	LOWER , pinze per vie biliari	37
LANE , tenaglie per ossa	457	LUCAE , martelli	430
LANGE , forbici per bendaggi	132	LUCAE , pinze nasale	77
LANGE , pinze per agrafes	225	LUCAS , scalpelli	417
LANGE-HOHMANN , elevatori per ossa	397	LUER , cannule per aspirazione	336
LANGENBECK , coltelli per amputazione	172	LUER , pinze per emorroidi, atrauma	48
LANGENBECK , divaricatori	254, 258	LUER , pinze-sgorbie	469
		LUETHY-BECK , portaghi tungsteno TUC	202

	Pagina		Pagina
M			
MAGILL , pinze per cannule	360	METZENBAUM-DELICATE , forbici tungsteno TUC	158-160
MAIER-SIMS , pinze per polipi	239	METZENBAUM-NELSON , forbici per preparazioni	109
Mani di piombo	482	MEYERDING , divaricatori	273
Manici per bisturi	165-167	MEYERDING , divaricatori autostatici	294
Manici per cannule di liposuzione e infiltrazione	338, 340	MEYERDING , divaricatori sottili	247
Marchiatore per facelift	376	MEYERDING-MARKHAM , divaricatori autostatici	294
MARKHAM-MEYERDING , divaricatori autostatici	294	MICHEL , agrafes	225
MARKWALDER , cesoie per ossa	477	MICHEL , pinze per agrafes	224
MARQUARDT , pinze-sgorbie	470	Micro forbici	143-149
MARTEL , pinze per il cuoio capelluto	12	Micro pinze	71, 72
Martelli	427-433	Micro portaghi	204-213
Martelli percussori	369, 370	MICRO-ADSON , pinze anatomiche e chirurgiche	59
MARTEL-WILLET , pinze per il cuoio capelluto	12	MICRO-FRIEDMAN , pinze-sgorbie	476
MARTIN , divaricatori	262	MICRO-MOSQUITO , pinze emostatiche	15
MARTIN , pinze per afferrare cartilagine	453	Micro-portaghi con manici rotondi	206-209
MARTIN-CARTILAGE , forbici	118	MICRO-RYDER , portaghi tungsteno TUC	193
MARTINI , curette taglianti	440	MICROVASCULAR , portaghi tungsteno TUC	193
MASS.-GENERAL-HOSPITAL (M.G.H.) , portaghi	183	MICRO-WULLSTEIN , cannule per aspirazione	335
MASSE-ROBIN , divaricatori addominali	306	MIDDELDORPF , divaricatori	264
MASSON , portaghi	184	MIKULICZ , divaricatori	268
MASSON , portaghi tungsteno TUC	197	MIKULICZ , pinze per peritoneo	49
MATHIEU , divaricatori	278	MIKULICZ-BABY , pinze per peritoneo	49
MATHIEU , portaghi	186	MILLER FIBRE OPTIC , laringoscopi a luce fredda	359
MATHIEU , portaghi tungsteno TUC	199	MILLER , laringoscopi	355
MATHIEU , specoli rettali	536	MILLER , pinze per carta di articolazione	98
MATHIEU-DELICATE , portaghi	186	MILLIGAN , divaricatori autostatici	288
MATHIEU-DELICATE , portaghi tungsteno TUC	199	MILLS , forbici	116
MATHIEU-RYDER VASCULAR , portaghi tungsteno TUC	200	MINI , lame per bisturi	167
MATHIEU-RYDER , portaghi tungsteno TUC	200	MINI , manici per bisturi	167
MATSON , periostotomi	446	MINI-FRIEDMAN , pinze-sgorbie	468
MAYFIELD , pinze-sgorbie	470	MINI-HOHMANN , elevatori per ossa	395
MAYO ROBSON , pinze stomacali e intestinali Atrauma	526	MINI-LAMBOTTE , osteotomi	426
MAYO , forbici	105	MINI-LANGENBECK , divaricatori sottili	247
MAYO , forbici tungsteno TUC	153	MINI-LEXER , osteotomi	422
MAYO , pinze per sterilizzazione	564	MINI-LEXER , scalpelli	422
MAYO-ADAMS , divaricatori autostatici	296	MISKIMON , divaricatori autostatici	289
MAYO-HARRINGTON , forbici	105	MIXTER , forbici per chirurgia	104
MAYO-HEGAR , portaghi	184	MIXTER , pinze per preparazioni e legature	33, 34
MAYO-HEGAR , portaghi tungsteno TUC	192	MIXTER-BABY , pinze per preparazioni e legature	33
MAYO-HEGAR-DELICATE , portaghi	184	MIXTER-O'SHAUGNESSY , pinze per preparazioni e legature	33
MAYO-HEGAR-DELICATE , portaghi tungsteno TUC	192	MIXTER-OVERHOLT , pinze per preparazioni e legature	29
MAYO-NOBLE , forbici	105	MOD. BONN , forbici fine	124
MAYO-ROBSON , pinze stomacali e intestinali	521, 526	MOD. BONN , pinze per iride	81
MAYO-RUSS. , pinze per afferrare tessuti	66	MOD. TÜBINGEN , divaricatori	262
MAYO-STILLE , forbici	105	MOD. TÜBINGEN , pinze per sutura	86
MAYO-STILLE , forbici tungsteno TUC	154	MOD. TÜBINGEN-VANNAS , forbici per cataratta secondarie	139
MC GIVNEY , legatori emorroidali	553	MOD. USA (SMITH) , forbici per bendaggi	133
MC INDOE , cesoie per ossa	478	MOD. USA , allarga gessi	319
MC INDOE , forbici	118	MOD. USA , forbici ombelicale	121
MC INDOE , pinze anatomiche e chirurgiche	60	MOD. USA , pinze anatomiche e chirurgiche	59
MC INTOSH FIBRE OPTIC , laringoscopi a luce fredda	357	MOD. WIEN , strumenti per legatura	223
MC INTOSH , laringoscopi	353	MODELL BONN , pinze per sutura	86
McDONALD , elevatori	448	MODELL TÜBINGEN , divaricatori	262
McDONALD , pinze capsulorhexis	90	MOELTGEN , goniometro	373
McPHERSON , pinze per sutura	85	MOLDESTAD , divaricatori sottili	244
MEAD , martelli	430	MOLLISON , divaricatori autostatici	289
MEAD , pinze-sgorbie	469	MOLT , periostotomi	444
MEEKER , pinze per preparazioni e legature	25	MOORE , perforatori a mano	387
MENGHINI , aghi per biopsia	344	MOORFIELD , pinze per sutura	84
Meniscotomi	467	MORGAN , anoscopi	541
MERIAM , pinze per cotone	96	MORGAN , luce fredda	541
METZENBAUM , forbici per preparazioni	108	MORRIS , divaricatori	261
METZENBAUM , forbici tungsteno TUC	155, 156	MOSQUITO-HALSTED , pinze emostatiche	15
METZENBAUM , portaghi tungsteno TUC	199	MOSQUITO-MICRO , pinze emostatiche	15
METZENBAUM-BABY , forbici per preparazioni	108	MOYNIHAN , pinze per isterectomia	44
METZENBAUM-DELICATE , forbici per preparazioni	110	MYRTLE-LEAF , sonde	310

N

NABATOFF , astuccio per varici	312
NAGER , aghi per legatura	219
NEFF , meniscotomi	467
NEGUS , pinze per vie biliari	40
NEIVERT , portaghi	181
NEIVERT , portaghi tungsteno TUC	195
NELATON , sonde	310
NELSON , pinze per afferrare tessuti	66
NELSON , trequarti	328
NELSON-METZENBAUM , forbici per preparazioni	109
NERVE , micro forbici	147
NEUMANN , forbici per gengiva	137
NEW ORLEANS , portaghi	183
NEW ORLEANS , portaghi tungsteno TUC	194
NIRO , tenaglie fili	401
NOBLE-MAYO , forbici	105
nopa PROFIL , sega per autopsia	484
NORTHBENT , forbici per legatura	129
NOTO , pinze per spugne	234
NOYES , forbici per iridectomia	138
NUSSBAUM , pinze stomacali e intestinali	523

O

O'BRIAN , forbici fine	124
OBWEGESER , divaricatori per ramo	257
OBWEGESER , divaricatori per tessuti molli	255, 256
OCHSNER , trequarti	329
OCHSNER-KOCHER , pinze emostatiche	20, 21
O'CONNOR , divaricatori sottili	243
O'CONNOR-O'SULLIVAN , divaricatori addominali	301
OEHLER , pinze tungsteno TUC	92
OLIVECRONA , forbici	117
OLLIER , divaricatori	253
OLSEN-HEGAR , portaghi	185
OLSEN-HEGAR , portaghi tungsteno TUC	198
OLSEN-HEGAR-USA , portaghi tungsteno TUC	198
OMBREDANNE , martelli	427
OSCINOPA , sega per autopsia	483
OSCINOPA , sega elettrica per gesso	321
O'SHAUGNESSY-MIXTER , pinze per preparazioni e legature	33
Osteotomi	417-426
O'SULLIVAN-O'CONNOR , divaricatori addominali	301
OTOSKOP UNI	381
OVERHOLT , pinze per preparazioni e legature	24
OVERHOLT-BABY , pinze per preparazioni e legature	23
OVERHOLT-GEISSENDOERFER , pinze per preparazioni e legature	23
OVERHOLT-MIXTER , pinze per preparazioni e legature	29

P

Padelle	563
PALMER , chiodi	496
PARAMETRIUM , forbici tungsteno TUC	154
PARAMETRIUM , pinze per parametrium	46
PARKER , divaricatori	278
PARKER-LANGENBECK , divaricatori	278
PARTSCH , martelli	430
PARTSCH , scalpelli	418
PATON , micro-portaghi	212
PAUFIQUE , pinze per sutura	86
PAYR , pinze e schiacciatori	530
PAYR , sonde conduttrice	221
PAYR-BABY , pinze e schiacciatori	530
PAYR-SCHMIEDEN , sonde conduttrice	221
PEAN , pinze per afferrare	13

PEAN-DELICATE , pinze emostatiche	22
PEAN-ROCHESTER , pinze emostatiche	18, 19
Pedicure	568-579
PEERS , pinze per fissare le compresse (Fissatele)	52
PEET , pinze per schegge	75
PELKMANN , pinze per tamponi	235
PENNINGTON , pinze per afferrare	13
PERCY , retrattore per amputazione	463
Perforatori a mano	385-390
Periostotomi	442-446
PERRY , pinze per cotone	97
PERTHES , perforatori a mano	390
Pestoni	451
Pettine	564
PHANEUF , pinze per isterectomia	45
PHILIPS , giravite	491
PIERCE , trequarti	330
PIFFARD , curette taglienti	436
PINARD , stetoscopi	377
Pinza di protezione	390
Pinze per vasi	12
Pinze	57-98
Pinze anatomiche per dissezione	57-65
Pinze atrauma	91
Pinze auricolare	77
Pinze auricolari	29
Pinze bulldog	10, 11
Pinze capsulare	83
Pinze chirurgiche a denti di topo	57-65, 67, 68
Pinze depilatorie	76
Pinze e schiacciatori per intestino e stomaco	530
Pinze emostatiche	9-53
Pinze emostatiche delicate	22
Pinze emostatiche fine	15
Pinze emostatiche per tonsille	27
Pinze fissatrice	84
Pinze intestinali	532, 533
Pinze intestinali e stomacali	520-523
Pinze micro	71, 72
Pinze muscolare	87, 88
Pinze nasale	77, 78
Pinze orologioiaio	69
Pinze per afferrare	12, 13, 316
Pinze per afferrare menisci e cartilagine	453
Pinze per afferrare l'intestino	9, 517-519
Pinze per afferrare tessuti	517, 518
Pinze per afferrare tessuti	9, 66-68, 70, 316
Pinze per agrafes	224, 225
Pinze per anastomosi	528, 529, 532, 533
Pinze per bronchi	30
Pinze per calazio	88, 89
Pinze per cannule	360
Pinze per carta di articolazione	98
Pinze per cotone	95-97
Pinze per emorroidi	47, 48
Pinze per emorroidi, atrauma	48
Pinze per entropio	88
Pinze per fissare le compresse	51, 52
Pinze per il cuoio capelluto	12, 26
Pinze per iride	79-82
Pinze per isterectomia	41-45
Pinze per la camera anteriore	85
Pinze per legature con piattaforma	71, 72
Pinze per lo strappo dello gesso	319
Pinze per marcazione	98
Pinze per medicature	78
Pinze per parametrium	46
Pinze per peduncoli renali	37-39
Pinze per peritoneo	49, 50

	Pagina		Pagina
Pinze per polipi	229-239	RANKIN-CRILE , pinze emostatiche	17
Pinze per posizionare	11	RANKIN-KELLY , pinze emostatiche	17
Pinze per preparazioni e legatura	23-25, 29, 31-36	Raspe	451
Pinze per pressione progressiva	47, 48	Recipienti cilindrici	562
Pinze per reposizione	487	Rectoscopi	544-550
Pinze per ritorcere fili TUC	203	REHN , coltelli per trapianti	175
Pinze per rompere le lamette	177	REILL , micro-portaghi	207
Pinze per schegge	73-75	REINER , coltelli per apparecchi gessati	318
Pinze per spugne	228-239	RESANO , pinze stomacali e intestinali	527
Pinze per sterilizzazione	564	Retratore per amputazione	463
Pinze per sutura	85, 86	REVERDIN , aghi	214
Pinze per tamponi	229-239	REVERDIN , spatole addominali	308
Pinze per vie biliari	37, 40	REYNOLDS , forbici per preparazioni	112
Pinze porta-lamelle	78	REZAK-HEANEY , pinze per isterectomia	44
Pinze serratubi	53	RIBBON , forbici oftalmologiche	127
Pinze stomacali	531	RICARD , divaricatori addominali	306
Pinze stomacali e intestinali atrauma	524-527	RICHARDSON (KELLY) , divaricatori	264
Pinze stomacali et intestinali	520-523	RICHARDSON-EASTMAN , divaricatori	264
Pinze taglienti per biopsia rettale	551	RICHTER , forbici per chirurgia	104
Pinze tungsteno TUC	92-94	RICHTER-HEATH , pinze per agrafes	224
Pinze-sgorbie	468-476	RIGHBY , divaricatori autostatici	295
Pistola lavatrice	590, 591	RIRAP , stetoscopi	378
Placche di carburo di tungsteno	190	RISCOPE S , astucci oftalmologiche	381
PLESTER , cannule per aspirazione	335	RISCOPE S , astucci oto-/oftalmologiche	380
PLESTER , divaricatori autostatici	295	ROBERTS , pinze emostatiche	30
POOLE , cannule per aspirazione	332	ROBIN-MASSE , divaricatori addominali	306
POOLE-BABY , cannule per aspirazione	332	ROCHESTER-CARMALT , pinze emostatiche	27
Portacotone	311, 312	ROCHESTER-PEAN , pinze emostatiche	18, 19
Portaghi	180-213	ROEDER , pinze per fissare le compresse (Fissatele)	52
Portaghi micro	204-213	ROETTGEN-RUSKIN , pinze-sgorbie	473
Portaghi tungsteno TUC	192-205	ROGGE , pinze per sterilizzazione	564
Portalegature	223	ROLLET , divaricatori sottile	246
POTTS-DE MARTEL , forbici	116	ROSCHKE , anoscopi	537
POTTS-SMITH , forbici	118	ROSSEGGGER-KLIMA , aghi per biopsia	343
POTTS-SMITH , forbici per chirurgia vascolare	113, 115	ROTTER , aghi per legatura	219
POTTS-SMITH , forbici tungsteno TUC	157	ROUX , divaricatori	277
POTTS-SMITH , micro-portaghi	212	ROWE , pinze per reposizione	487
POTTS-SMITH , micro-portaghi tungsteno TUC	205	Rubinetti	349
POTTS-SMITH , pinze anatomiche e chirurgiche	63	RUDD , legatori emorroidali	554
POTTS-SMITH , pinze tungsteno TUC	92	RUMEL , pinze per preparazioni e legature	31
PRATT , pinze per emorroidi	47	RUSKIN , pinze-sgorbie	471, 475
PRATT , sonda per fistule	311	RUSKIN-LISTON , cesoie per ossa	478
PRATT , specoli rettali	536	RUSKIN-MINI , pinze-sgorbie	471
PRECISA , sfigmomanometro	379	RUSS. MOD. , pinze per afferrare tessuti	68
PRESBYTERIAN , pinze serratubi	53	RYDER-FRENCH-EYE , portaghi tungsteno TUC	193
PRINCE , forbici per tonsille	119	RYDER-LANGENBECK , portaghi tungsteno TUC	202
PRINCE , pinze muscolare	87	RYDER-MATHIEU VASCULAR , portaghi tungsteno TUC	200
Protoscopi	537-543	RYDER-MATHIEU , portaghi tungsteno TUC	200
PROVIDENCE-HOSPITAL , pinze emostatiche	16	RYDER-MICRO , portaghi tungsteno TUC	193
Puntura	327-349		
PUTTI , raspe	451	S	
PYE-SMITH (HARRISON) , pinze per sterilizzazione	564	SALAH , aghi per biopsia	343
PYNCHON-ANDREWS , cannule per aspirazione	331	SALENIUS , meniscotomi	467
Q		SAMII , pinze	70
QUINBY , forbici per gengiva	137	SANVENERO , forbici per preparazioni	112
QUINKE , aghi per biopsia	344	SAROT , pinze per bronchi	30
R		SAROT , portaghi	183
RABINER , martelli percussori	369	SAROT , portaghi tungsteno TUC	197
Raccordi	349	SATINSKY , forbici	117
RADOLF , pinze per unghie	482	SATTERLEE , seghe per amputazione	384
RAGNELL (KILNER) , forbici per preparazioni	112	SATTLER , pinze muscolare	87
RAGNELL-DAVIS , divaricatori sottili	250	SAUERBRUCH , divaricatori	256, 270
RALK , perforatori a mano	389	SAUERBRUCH , pinze-sgorbie	474
RALK , pinze per schegge	75	SAWTELL-SCHNIDT , pinze emostatiche per tonsille	27
RAMPLEY , pinze per spugne	238	SAWYER , specoli rettali	534
		SCALP-CONTOUR , divaricatori autostatici	294
		Scalpelli	417-426
		Scatole per sterilizzare aghi	560

Scatole per strumenti	562	SMITH-POTTS , forbici per chirurgia vascolari	113, 115
SCHAEDEL , pinze per fissare le compresse (Fissatele)	51	SMITH-POTTS , micro-portaghi	212
SCHANZ , fili	503	SMITH-POTTS , micro-portaghi tungsteno TUC	205
SCHEDÉ , curette taglienti	435	SNELLEN , pinze per entropio	88
SCHINDLER , pinze per peritoneo	50	SNITMAN , divaricatori autostatici	284
SCHINK , dermatomo	176	Sonde	310, 311
SCHMID , aghi speciali	345	Sonde	310.311
SCHMIEDEN , aghi per legatura	217	Sonde conduttrici	220-222
SCHMIEDEN-PAYR , sonde conduttrice	221	Spatole addominali	308
SCHMIEDEN-TAYLOR , forbici	116	Spazzuli per puliere	583-589
SCHNIDT-SAWTELL , pinze emostatiche per tonsille	27	Specchi frontali	367
SCHOEMAKER , forbici per gozzo	119	Specoli rettali	534-536
SCHOEMAKER-LOTH , forbici per legatura	128	SPENCER , forbici per legatura	128
SCHUHKNECHT , divaricatori autostatici	289	SPENCER-DELICATE , forbici per legatura	128
SCHUKNECHT , forbici per filo metallico	130	SPENCER-WELLS , pinze emostatiche	14
SCHULZE-BERGMANN , specoli rettali	535	SPRATT , curette taglienti	435
SCHUMACHER , forbici ombelicale	121	ST. MARKS , divaricatori	275
SCHWECKENDICK-GOOD , forbici per tonsille	119	ST. MARTIN , pinze per sutura	85
Scollatendini	465	STACKE , sonde	310
SCUDDER , pinze stomacali e intestinali	523, 526	STADLER-BRAUN , forbici per episiotomia	121
SCUDDER , pinze stomacali e intestinali Atrauma	526	STANDARD , forbici per chirurgia	102
SEBILEAU , elevatori	447	STANDARD , forbici per gengiva	137
SEDILLOT , periostotomi	445	STANDARD , forbici tungsteno TUC	152, 153
Sega per autopsia	483-485	STANDARD , pinze anatomiche per dissezione	57
Segha elettrica per gesso	321, 322	STANDARD , pinze chirurgiche a denti di topo	57
Seghe	384, 482-485	STANDARD , tre quarti	327
Seghe per amputazione e resezione	384	STEINBACH , martelli	432
Seghe per anelli	482	STEINMANN , chiodi	399, 497, 498
Seghe per apparecchi gessati	318	STEINMANN , strumenti per afferrare tendini	464
SEGOND , pinze per isterectomia	45	STELLBRINK , pinze-sgorbie	468
SEGOND-LANDAU , pinze per isterectomia	45	STERNUM , portaghi tungsteno TUC	203
SELLORS-CRAFOORD , pinze auricolari	29	STERNUM , tenaglie TUC per fili	403
SEMB , cesoie per ossa	480	Stetoscopi	377, 378
SEMB , periostotomi	446	STEVENS , forbici per tenotomia	126
SEMB , pinze-sgorbie	472	STEVENS , forbici tungsteno TUC	161
SEMB , tenaglie per ossa	456	STEVENS , micro-portaghi	212
SEMKEN , pinze anatomiche e chirurgiche	60, 61	STEVENS , pinze per iride	80
SEMKEN , pinze tungsteno TUC	92	STIEGLITZ , pinze per schegge	75
SEMM , divaricatori addominali	303	STILLE , cesoio per gesso	320
SENN-GREEN , divaricatori sottili	247	STILLE , osteotomi	421
SENNING (SCHWED. MODELL) , portaghi	183	STILLE , perforatori a mano	386
SENNING (SCHWED. MODELL) , portaghi tungsteno TUC	194	STILLE , pinze anatomiche e chirurgiche	65
SENN-MILLER , divaricatori sottili	250	STILLE , pinze per peduncoli renali	38
SENN-MILLER-BABY , divaricatori sottili	250	STILLE , pinze-sgorbie	472
SEUTIN , forbici per bendaggi	134	STILLE , scalpelli	421
Sfigmomanometro a mercurio	379	STILLE-BARRAYA , pinze chirurgiche a denti di topo	65
Sfinteroscopi	537-541	STILLE-DOYEN , divaricatori	266
SHORTBENT , forbici per legatura	129	STILLE-LISTON , cesoie per ossa	479
SIEBOLD , forbici per ginecologia	107	STILLE-LUER , pinze-sgorbie	473
SIMON , bisturi per fistole	174	STILLE-MAYO , forbici	105
SIMON , divaricatori	262	STILLE-MAYO , forbici tungsteno TUC	154
SIMS , forbici per ginecologia	107	STILLE-RUSKIN , pinze-sgorbie	472
SIMS , forbici tungsteno TUC	155	STILLE-SHERMAN , perforatori a mano	385
SIMS , specoli rettali	534	STRATTE , portaghi	185
SIMS-MAIER , pinze per polipi	239	STRATTE , portaghi tungsteno TUC	197
SINGLEY-TUTTLE , pinze per afferrare tessuti	66	STRAUSS , rectoscopi	548
SINUSCOPY , tre quarti	327	STRULLY , forbici	115
Siringhe	348	Strumenti per afferrare tendini	464
Siringhe fiali	347	Strumenti per chiodi Küntscher	488, 489
SMILLIE , divaricatori per il ginocchio	466	Strumenti per misurare	371-375
SMILLIE , meniscotomi	467	Strumenti per nodi	223
SMITH (MOD. USA) , forbici per bendaggi	133	Strumenti per sensibilità	376
SMITH , forbici per filo metallico	130	Strumenti tendi fili	407
SMITH-BUIE , specoli rettali	536	SULLIVAN (BROPHY) , forbici fine	123
SMITH-HEYWOOD , pinze per spugne	236	SULLIVAN , forbici per gengiva	137
SMITH-PETERSEN , osteotomi	419	Super Cut forbici SC	101
SMITH-PETERSEN , scalpelli	419	Sutura	180-225
SMITH-PETERSON , pinze-sgorbie	475	SYME , aghi per legatura	216
SMITH-POTTS , forbici	118		

T

TAYLOR , divaricatori spinali	250
TAYLOR , elevatori per ossa	398
TAYLOR , martelli percussori	369
TAYLOR , pinze anatomiche e chirurgiche	61
TAYLOR-CUSHING , pinze tungsteno TUC	93
TAYLOR-SCHMIEDEN , forbici	116
Tenaglie fili	401-403, 405, 406
Tenaglie per ossa	394, 452, 454-462
Tenaglie piatte	404
TERRIER , pinze emostatiche	14
TERSON , pinze per iride	83
THIERSCH , coltelli per trapianti	175
THIESS , martelli	430
THOMS-ALLIS , pinze per afferrare tessuti e l'intestino	518
THOREK , forbici per preparazioni	111
THORPE , calibratore	372
Tiravene	315
TOENNIS , forbici	116
TOENNIS , pinze per preparazioni e legature	36
TOENNIS , portaghi	188
TOENNIS , portaghi tungsteno TUC	201
TOENNIS-ADSON , forbici	116
TOENNIS-ADSON-DELICATE , forbici tungsteno TUC	161
TOHOKU-JAPAN , pinze per fissare le compresse (Fissatele)	52
Torcifilo	223
TOWNLEY , calibratore	372
TRAVERS , divaricatori autostatici	288
Trefina per apparecchi gessati	318
TRELAT , aghi per legatura	218
Trequarti	327-330
TROCAR , aghi per biopsia	344
TROELTSCH (WILDE) , pinze auricolare	77
TROEMNER , martelli percussori	370
Tronchesine per unghie	568-570
TROUTMAN (CORNEAL) , pinze per iride	82
TROUTMAN , forbici per cornea	141
TROUTMAN , micro-portaghi	207
TROUTMAN-BARRAQUER , micro-portaghi	206
TROUTMAN-CHRIS , pinze per rompere le lamette	177
TÜBINGER MODELL , divaricatori	262
TÜBINGER MODELL , divaricatori autostatici	296
TUDOR-EDWARDS , cesoie per ossa	479
TUFFIER , divaricatori	267
TUFFIER , pinze per afferrare	12
TUFFIER , spatole addominali	308
TUOHY , aghi per biopsia	344
TURNBULL , tronchesine per unghie	568
TUTTLE-SINGLEY , pinze per afferrare tessuti	66

U

UCKERMANN , portacotone	312
ULRICH , pinze per polipi	229
ULRICH , tenaglie per ossa	462
UNIVERSAL , forbici per bendaggi	132
UNIVERSAL , forbici per filo metallico	130
UNIVERSAL , forbici tungsteno TUC	162
UNIVERSAL , perforatori a mano	389
UNIVERSAL , pinze-sgorbie	468
UNIVERSAL , trequarti	327

V

VACUNOPA , vacuum cleaner	324
VAN BUREN , tenaglie per ossa	452
VANNAS , forbici per cataratta secondaria	139

VANNAS-MOD. TÜBINGEN , forbici per cataratta secondaria	139
Vassoio	561
VERBRUGGE , tenaglie per ossa	459
VERNET-GIL , divaricatori sottili	249
VERNIER , calibratore	372, 373
VERRES , aghi speciali	345
VIRCHOW , coltelli per cervello	173
WISE , pinze per legature con piattaforma	71
Viti per ossa	505-512
VOLKMANN , curette taglienti	434, 440
VOLKMANN , divaricatori	251, 252

W

WACHENFELD , pinze per agrafes	224
WAGNER , forbici fine	122
WALB , coltelli per autopsia	173
WALDMANN , forbici per episiotomia	121
WALTER , divaricatori	250
WALTER-CARMALT , pinze per schegge	73
WALTON , divaricatori autostatici	297
WALTON , forbici	124
WALTON , pinze per polipi	239
WALTON , seghe per anelli	482
WALTON-LISTON , cesoie per ossa	478
WALTON-YANKAUER , cannule per aspirazione	331
WANGENSTEEN , pinze anatomiche e chirurgiche	65
WANGENSTEEN , pinze tungsteno TUC	94
WANGENSTEEN , portaghi	185
WANGENSTEEN , portaghi tungsteno TUC	197
WANGENSTEEN-DELICATE , portaghi	185
WARTENBERG , strumenti sensibilità	376
WATSON , dermatomo	176
WAUGH , pinze per afferrare tessuti	67
WEBSTER , portaghi	181
WEBSTER , portaghi tungsteno TUC	195
WECKER , forbici per iridectomia	138
WEITLANER , divaricatori autostatici	287
WEITLANER-BABY , divaricatori autostatici	287
WELLS-SPENCER , pinze emostatiche	14
WERTHEIM , forbici	106
WERTHEIM , pinze per isterectomia	41, 42
WERTHEIM , portaghi	185
WERTHEIM , portaghi tungsteno TUC	198
WERTHEIM-CULLEN , pinze per isterectomia	44
WESTCOTT , forbici per tenotomia	140
WESTCOTT , micro forbici	143
WESTERMARK , pinze per spugne	232
WIGMORE , coltelli per apparecchi gessati	318
WIKSTROEM , pinze per preparazioni e legatura	41
WILDBERG , grappas	496
WILDE (TROELTSCH) , pinze auricolare	77
WILLET-MARTEL , pinze per il cuoio capelluto	12
WILLIAMS , pinze per afferrare tessuti e l'intestino	518
WILLIGER , curette taglienti	440
WILLIGER , elevatori	447
WILLIGER , martelli	428
WILLIGER , peristotomi	444
WILMER , forbici oftalmologiche	126
WISCONSIN (FOREGGER) FIBRE OPTIC , laringoscopi a luce fredda	358
WISCONSIN (FOREGGER) , laringoscopi	354
WOLFF , pinze per lo strappo dello gesso	320
WULLSTEIN MICRO , cannule per aspirazione	335
WULLSTEIN , divaricatori autostatici	289

Y

YANCOSKIE , divaricatori abdominoplastia	280
---	-----

Pagina

YANKAUER , cannule per aspirazione	331
YANKAUER-WALTON , cannule per aspirazione	331
YEOMAN , pinze tagliente per biopsia rettale	551
YOUNG-HRYNTSCHAK , portaghi boomerang	189

Z

ZAUFAL-JANSEN , pinze-sgorbie	471
ZENKER , divaricatori	272
ZENKER , pinze per preparazioni e legature	32
ZIEGLER , pinze depilatorie	76
ZWEIFEL , portaghi	187
ZWEIFEL , portaghi tungsteno TUC	202

nopa[®] instruments

nopa instruments

Medizintechnik GmbH

Weilatten 7-9

D - 78532 Tuttlingen

Tel. +49.7462.9490-0

Fax +49.7462.9490-90

info@nopa.de

www.nopa.de

Herstellung und Verkauf chirurgischer
und endoskopischer Instrumente.

Manufacture and Sales of Surgical
and Endoscopic Instruments.

